

**N ATTENUATOR**  
**1 DB 18 GHZ 2W**

**R414.701.161**  
Series : **ATTENUATOR**

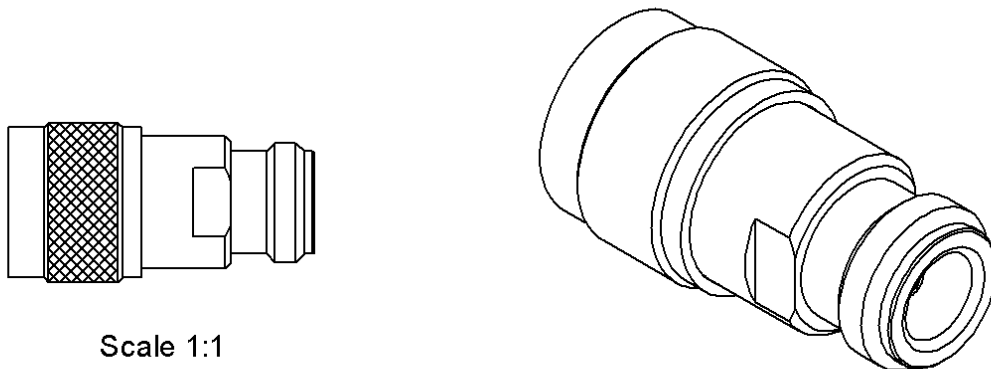

All dimensions are in mm.

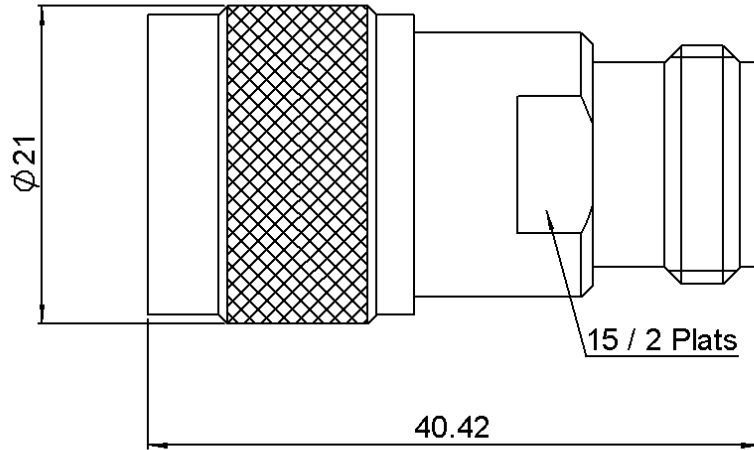

COMPONENTS	MATERIALS	PLATING( $\mu\text{m}$ )
BODY	STAINLESS STEEL	PASSIVATED
MALE CENTER CONTACT	BERYLLIUM COPPER	GOLD 1.2 OVER NICKEL 2
FEMALE CENTER CONTACT	BERYLLIUM COPPER	GOLD 1.2 OVER NICKEL 2
OUTER CONTACT		
INSULATOR	PTFE	
GASKET	SILICONE RUBBER	
SUBSTRATE	ALUMINA	
RESISTOR	THIN FILM	
OTHERS PARTS		

Issue : 0839 A

In the effort to improve our products, we reserve the right to make changes judged to be necessary.

**N ATTENUATOR**  
**1 DB 18 GHZ 2W**

**R414.701.161**  
 Series : ATTENUATOR

**ELECTRICAL CHARACTERISTICS**

Frequency (GHz)	DC - 4	4 - 8	8 - 12.4	12.4 - 18
V.S.W.R (≤)	1.15	1.20	1.25	1.35
Deviation(±dB)	0.40	0.40	0.40	0.40

Operating Frequency Range	DC - 18	GHz
Impedance	50	Ω
Nominal Attenuation	1	dB
Peak power at 25°C (1μs, 1%)	100	W
Average power at 25°C	2	W (Free Air Cooled)
		W (Conduction Cooled)

**MECHANICAL CHARACTERISTICS**

Connectors	N	Male Female	MIL-C 39012
Weight	60,0400 g		

**ENVIRONMENTAL CHARACTERISTICS**

Operating temperature range	-55 /+125 °C
Storage temperature range	-55 /+125 °C



**SPECIFICATION**

**OTHER CHARACTERISTICS**

Issue : 0839 A

In the effort to improve our products, we reserve the right to make changes judged to be necessary.

