

# Delta UPS - Amplon Family

RT Series, Single Phase

1/ 1.5/ 2/ 3 kVA

## Installation & Operation Quick Guide

ENGLISH

### 1 Product Introduction

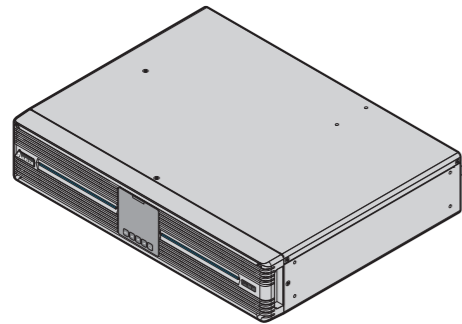

The RT series UPS, available in 1kVA, 1.5kVA, 2kVA and 3kVA, is an advanced on-line, single-phase and double-conversion Uninterruptible Power Supply (UPS) providing reliable and consistent sine-wave quality power to your equipment. It supports personal computers, networks, servers, telecommunication equipment and a variety of other facilities.

Each model has internal batteries and can connect to the Delta external battery pack (optional). The unit provides output power factor up to 0.9, produces greater electric power efficiency at less cost, and keeps your applications safe and running smoothly at all times. The nominal rating voltage of internal batteries is 24V (1kVA), 36V (1.5kVA), 48V (2kVA) and 72V (3kVA) respectively.

### 2 Important Safety Instructions

#### • Caution

To reduce the risk of fire, only connect the UPS to a circuit with branch circuit overcurrent protection in accordance with the National Electrical Code, ANSI/ NFPA 70 and the Canadian Electrical Code, Part 1, C22.1.

The maximum current of the branch breaker is listed in the table below.

Model	Maximum current of branch breaker
UPS102R1RT0B0B8	15A
UPS152R1RT0B0B8	20A
UPS202R1RT0B0B8	20A
UPS302R1RT0B0B8	30A

#### • Placement & Installation Warnings

1. Install the UPS in a well-ventilated area, away from extreme temperatures, excess moisture, heat, dust, flammable gas or explosives.
2. Leave adequate space at least 15cm in front and at rear of the UPS for proper ventilation. Also, leave necessary space to allow service personnel's access to the UPS for maintenance.
3. The UPS can be installed vertically (tower-mounting) or horizontally (rack-mounting) according to the user's desired arrangement. Please obey the following:
  - Do not mount the UPS with its front or rear panel facing down at any angle.
  - Keep the UPS upright at all times and handle it with care.
  - Do not stack the units.

- Do not place any objects on the UPS, the Delta external battery pack(s) (optional) or any other accessory associated with the UPS.
  - Install the UPS and the Delta external battery pack (optional) on a flat surface.
  - Ensure the installation area can bear the weight of the UPS, the Delta external battery pack (optional), tower stands (optional) or the rack.
  - For rack-mounting installation, do not let the rack become 'top heavy'. Install the heaviest equipment near the bottom of the rack. For weight information about the UPS and the Delta external battery pack(s) (optional), please refer to **10. Technical Specifications**.
4. To reduce the risk of electric shock, install the UPS in a temperature and humidity controlled indoor area free of conductive contaminants. Please refer to **10. Technical Specifications** and the system block diagram below for correct installation.

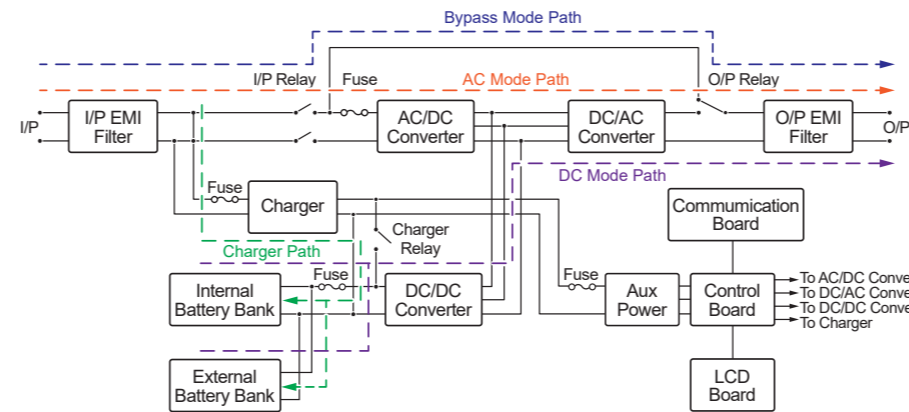

#### • General Warnings

1. Electrical shock hazard: even when the UPS is disconnected from the mains, hazardous voltage may still exist at the output receptacles of the UPS. Before maintenance, cut off the AC source and disconnect the UPS and the external battery pack. After that, follow the instruction about **Internal Battery Replacement** in the **User Manual for Delta Amplon RT 1/ 1.5/ 2/ 3 kVA UPS** to remove the internal batteries. Only after the above procedures are completed, can the further maintenance action be executed.
2. Even when all switches and/ or circuit breakers are open, dangerous voltage will be present within the unit.
3. Forbid opening or removing the cover of the UPS to avoid high voltage electric shock. There are no user-serviceable parts inside.
4. Maintenance service must be performed by qualified service personnel.
5. Any repairs or modifications by the user may result in out-of-warranty repair charges or unsafe electrical conditions.
6. Do not use extension cords to connect the UPS to an AC outlet.
7. Do not plug the UPS's input cord into its own output receptacles.

#### • Usage Warnings

1. Before usage, you must unpack the UPS and allow it to adjust to room temperature (20°C~25°C) for at least two hours to avoid moisture condensing inside the UPS.
2. To ensure reliable operation of the UPS and to protect the UPS from overheating, the slits and openings in the UPS must not be blocked or covered.
3. The UPS will not be isolated from the mains even if it is off. To completely isolate the UPS from the mains, please disconnect the input power cord.
4. The unit supplies power from two sources, the mains and the batteries. The output receptacles may have voltage present even when the unit is unplugged. Unplugging the UPS puts it into battery mode and the batteries supply power to the connected loads.
5. Route all cords well so that nobody can stand on them or trip over them.
6. Ensure that no objects (e.g. rings, necklaces, paper clips, etc.) get inside the unit.
7. In an emergency, switch off the unit, disconnect it from the mains and contact the responsible customer service representative.
8. Do not connect any equipment that requires DC current.
9. Do not connect any equipment that may overload the UPS.
10. Do not connect or disconnect any cables during a thunderstorm.
11. The sum of current leakage from the UPS and its connected loads must not exceed 3.5 mA.

12. The UPS has a REPO (remote emergency power off) port located at the rear.
13. The UPS must be well grounded due to a possible risk of current leakage. The unit is equipped with a safety approved mains line and must be connected to an earthing-contact wall socket. If the wall socket does not have an earthing connection, please ground the UPS via the ground terminal located at the rear of the UPS. Please refer to **5 Rear Panel**.
14. Ensure that the sockets on the unit or the earthing-contact wall socket are freely accessible.
15. The RT series UPS is **ONLY** intended to be installed in an indoor temperature controlled environment that is free of conductive contaminants. This UPS series is not intended for use in a computer room as defined in the Standard for the Protection of Electronic Computer/ Data Processing equipment ANSI/ NFPA 75.

#### • Battery Precautions

1. Do not open or mutilate the battery or batteries. The released electrolyte is harmful to the skin and eyes and may be toxic. If the electrolyte splashes into your eyes or onto your skin, immediately flush them out with water and seek immediate medical advice.
2. Do not dispose of the battery or batteries in a fire. The batteries may explode.
3. The risk of dangerous voltage is possible when the batteries or battery packs are still connected to the UPS even though the UPS is disconnected from the mains. Do not forget to disconnect the battery cable to completely cut off the battery source.
4. Voltage is always present on the battery terminals.
5. Even when discharged, a battery has the capacity to supply a high short circuit current, which, in addition to causing damage to the battery itself and to associated cables, may expose the operator to the risk of burns.
6. To ensure battery performance, idle batteries must be fully recharged every three months if the UPS needs to be stored for an extended period of time. Ensure that, every time after charging, the battery capacity percentage shown on the UPS's LCD is 100% .
7. Since new batteries often do not provide full capacity after an initial charge, it may be necessary to carry out a number of discharge/ recharge cycles before optimum performance is achieved.
8. Servicing of batteries and battery packs should be performed or supervised by qualified service personnel knowledgeable in batteries, battery packs and the required precautions.
9. Only use the same type and number of batteries from the supplier. Never use old, new and different Ah batteries at the same time. The types of batteries are HRC9-12 (BB), HR9-12 (BB), and HR9-12-T2 (BB).
10. A battery can present a risk of electrical shock and high short-circuit current. The following precautions should be observed when working on batteries:
  - Remove watches, rings, or other metal objects.
  - Use tools with insulated handles.
  - Wear rubber gloves and boots.
  - Do not lay tools or metal parts on top of batteries.
  - Disconnect the charging source prior to connecting or disconnecting the battery terminals.
  - Remove battery grounds during installation and maintenance to reduce likelihood of shock. Remove the connection from ground if any part of the battery is determined to be grounded.

### 3 Standard Compliance

- UL 1778, CAN/ CSA C22.2 NO 107.3-14
- CE
- IEC/ EN 62040-1+ A1
- EN 62040-2 Category C1
- 1/ 1.5K: CISPR22 Class B/ FCC part 15 Class B
- 2/ 3K: CISPR22 Class A/ FCC part 15 Class A
- Energy Star

## 4 Packaging List

The UPS package contains the following items. Please check if any items are missing. If there is anything missing, please immediately contact the dealer.

### • UPS102/ 152/ 202/ 302R1RT0B0B8

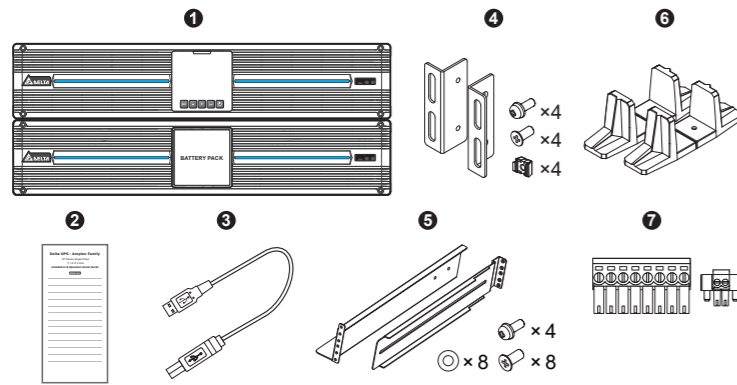

No.	Item	Q'ty	1kVA	1.5kVA	2kVA	3kVA
1	UPS	1 PC	✓	✓	✓	✓
2	Installation & Operation Quick Guide	1 PC	✓	✓	✓	✓
3	USB cable	1 PC	✓	✓	✓	✓
4	Bracket Ear	1 SET	✓	✓	✓	✓
5	Rail Kit	1 SET	✓	✓	✓	✓
6	Tower Stand	1 SET	✓	✓	✓	✓
7	Terminal Kit	1 SET	✓	✓	✓	✓

## 5 Rear Panel

### • UPS102R1RT0B0B8

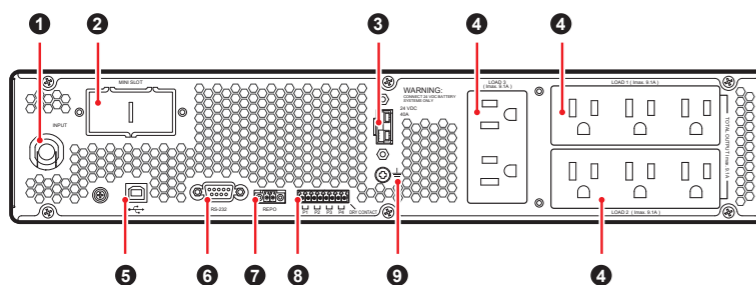

### • UPS152R1RT0B0B8

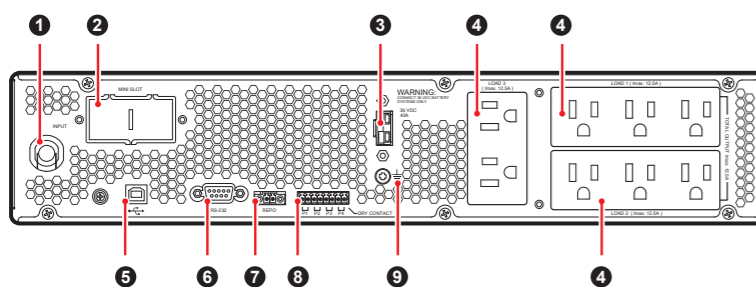

### • UPS202R1RT0B0B8

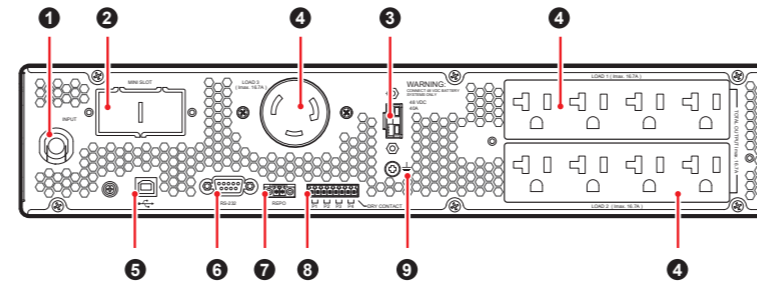

### • UPS302R1RT0B0B8

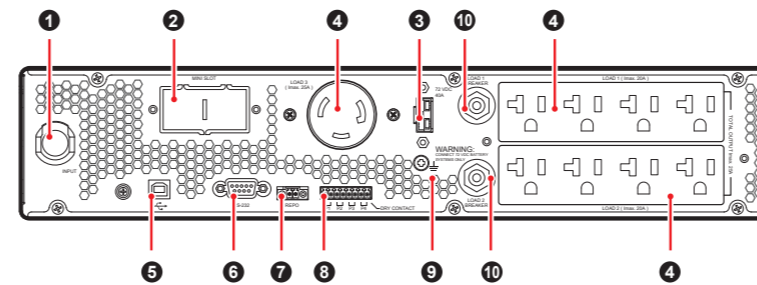

No.	Item	Functions
1	<b>Input Power Cord</b>	Connects the UPS to the mains.
2	<b>MINI Slot</b>	Connects a Mini SNMP/ Mini SNMP IPv6/ Mini Relay I/O/ Mini MODBUS card.
3	<b>External Batt. Connector</b>	Connects to the external battery pack(s) (optional) to extend back up time. (1 kVA: 24V DC 40A) (1.5 kVA: 36V DC 40A) (2 kVA: 48V DC 40A) (3 kVA: 72V DC 40A)
4	<b>Output Socket(s)</b>	Connect(s) to the loads.
5	<b>USB Port</b>	Connects to a computer so you can monitor the state of the UPS, configure the UPS parameters and update the management software. (UPSentry 2012 Software is required. Please download it from <a href="http://www.deltapowersolutions.com/en/mcis/software-center.php">http://www.deltapowersolutions.com/en/mcis/software-center.php</a> ).
6	<b>RS-232 Port</b>	Connects to a computer so you can build up RS-232 communication, configure the UPS and upgrade the UPS firmware. (UPSentry 2012 Software is required. Please download it from <a href="http://www.deltapowersolutions.com/en/mcis/software-center.php">http://www.deltapowersolutions.com/en/mcis/software-center.php</a> ).
7	<b>REPO Port</b>	When emergency events occur, it can shut down the UPS safely and immediately.
8	<b>Dry Contacts</b>	1. Output dry contacts: Receive the UPS's event information to indicate the UPS status or internal messages. 2. Input dry contact: Lets the UPS to receive external controlling signals.
9	<b>⏏</b>	For external battery pack grounding.
10	<b>Output Breaker(s)</b>	Prevent(s) the output socket from damage caused by overload.

## 6 Operation Panel

On the front panel of the UPS, you'll see two LED indicators, a LCD display, and multi-function buttons.

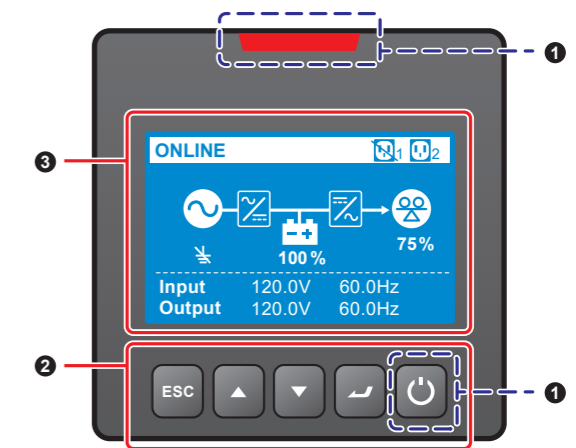

1 6.1 LED indicators 2 6.2 Multi-function Buttons 3 6.3 LCD Display

### 6.1 LED Indicators

No.	LCD	Description
1		1. <b>ON</b> : The output is protected. 2. <b>OFF</b> : The output is not protected.
2		1. <b>ON</b> : The UPS detects an internal fault or an environmental fault. 2. <b>OFF</b> : The UPS is in normal state. 3. <b>Flashing</b> : The UPS shows the warning message(s). Please check the corresponding warning message(s) in <b>8 Troubleshooting</b> .

### 6.2 Multi-function Buttons

No.	Multi-function Button	Description
1	<b>ON/ OFF Button</b> 	<b>1. Turn-on</b> <ul style="list-style-type: none"> <li>In standby/ bypass mode, press and hold the button for 3 seconds, release it after you hear one beep and the UPS will run in on-line mode.</li> <li>Cold start: When there is no AC input, press and hold the button for 3 seconds, release it after you hear one beep and the UPS will run in battery mode.</li> </ul> <b>2. Turn-off</b> <ul style="list-style-type: none"> <li>In on-line mode, press and hold the button for 3 seconds, release it after you hear one beep and the inverter will be off and the UPS will transfer to run in standby/ bypass mode. The UPS will keep charging the batteries when the UPS is in standby/ bypass mode. To fully turn off the UPS, it is advised to disconnect the UPS from the AC power.</li> <li>In battery mode, press and hold the button for 3 seconds, release it after you hear one beep and the UPS will turn off its output.</li> </ul>



No.	Multi-function Button	Description
2	Enter Button	<p><b>1. Entering into the setup mode</b> In the <b>Main Screen</b> (that shows the current operation mode), press the button for 0.1 second and the UPS will enter into the <b>Main Menu</b> (setup mode). Please refer to 6.2.1 &amp; 6.2.2</p> <p><b>2. Selecting and confirming the parameter in setup mode</b> In setup mode, press the button to choose the parameter you want to change, then the parameter will flash, press the <b>Scrolling up</b> or the <b>Scrolling down</b> button to change the parameter and press this button again to confirm the change.</p>
3	Scrolling UP Button	<p><b>1. Scrolling Up/ Increasing Number</b></p> <ul style="list-style-type: none"> <li>In the <b>Main Screen</b>, press the button for 0.1 second and the UPS will directly enter into the <b>Measurement Menu's</b> level 3 (see <b>Figure 6.2.1: Menu Tree</b>), which contains related <b>Output</b> information.</li> <li>In setup up mode, this button is used to navigate the setting items. Press the button for 0.1 second to go to the previous setting item.</li> <li>The button is also used to navigate or set up the setting parameter. Press the button for 0.1 second to the previous display or to increase a number. If the button is pressed for more than 2 seconds, the number will be increased single digit every 0.2 second automatically until the button is released or the number has reached its highest value.</li> </ul> <p><b>2. Reset LCD</b> Press the <b>Scrolling Up</b> and the <b>Scrolling Down</b> buttons together for 3 seconds to reset the LCD display.</p>
4	Scrolling Down Button	<p><b>1. Scrolling Down/ Decreasing Number</b></p> <ul style="list-style-type: none"> <li>In the <b>Main Screen</b>, press the button for 0.1 second and the UPS will directly enter into the <b>Measurement Menu's</b> level 3 (see <b>Figure 6.2.1: Menu Tree</b>), which contains related <b>Output</b> information.</li> <li>In setup-up mode, this button is used to navigate the setting items. Press the button for 0.1 second to go to the next setting item.</li> <li>The button is also used to navigate or set up the setting parameters. Press the button for 0.1 second to the next display or to decrease a number. If the button is pressed for more than 2 seconds, the number will be decreased single digit every 0.2 second automatically until the button is released or the number has reached its lowest value.</li> </ul> <p><b>2. Reset LCD</b> Press the <b>Scrolling Up</b> and the <b>Scrolling Down</b> buttons together for 3 seconds to reset the LCD display.</p>
5	Escape Button	<p><b>1. Back to the Previous Menu Level</b> In setup mode, press the button for 0.1 second to go back to the previous menu level.</p> <p><b>2. Fault Clear</b> When the UPS has a fault condition, press and hold the button for 3 seconds, release it after you hear one beep and the UPS will try to clear the fault condition.</p> <p><b>NOTE:</b> When the UPS clears the fault condition, it means that the buzzer/ warning message has been turned off. To eliminate the fault detected, please refer to <b>8 Troubleshooting</b> for relevant solutions.</p>

- NOTE:**
- When the backlight of the LCD is off, you can press any button mentioned above for 0.1 second to wake up the LCD display and enable each button function.
  - For more information about the setup mode, please refer to **6.2.1 Main Menu** & **6.2.2 Setup Mode**.

### 6.2.1 Main Menu

Please note that only qualified service personnel can perform setup action. The **Menu Tree** shown below provides the overview of setup items. In the **Main Screen** that shows the current operation mode, press the button (  ) for 0.1 second to enter into the **Main Menu**. You can set up relevant items here.

The **Measurement Menu** displays the UPS's status readings, such as **Output, Input, Bypass** and **Battery** information.

The **Control Menu** provides commands for enabling specific UPS functions.

The **Maintenance Menu** lists commands for enabling UPS maintenance functions. It also provides event logs and UPS identification.

In **Setting Menu**, you can choose the set up items such as **Output, Input, ECO Mode, On/Off Settings, Battery, General, Outlet Control, Dry Contacts Setting, and Component Life Prediction** to set up relevant settings. For more information, please refer to the table in 6.2.2 for each setup item's relevant default value and selectable value.

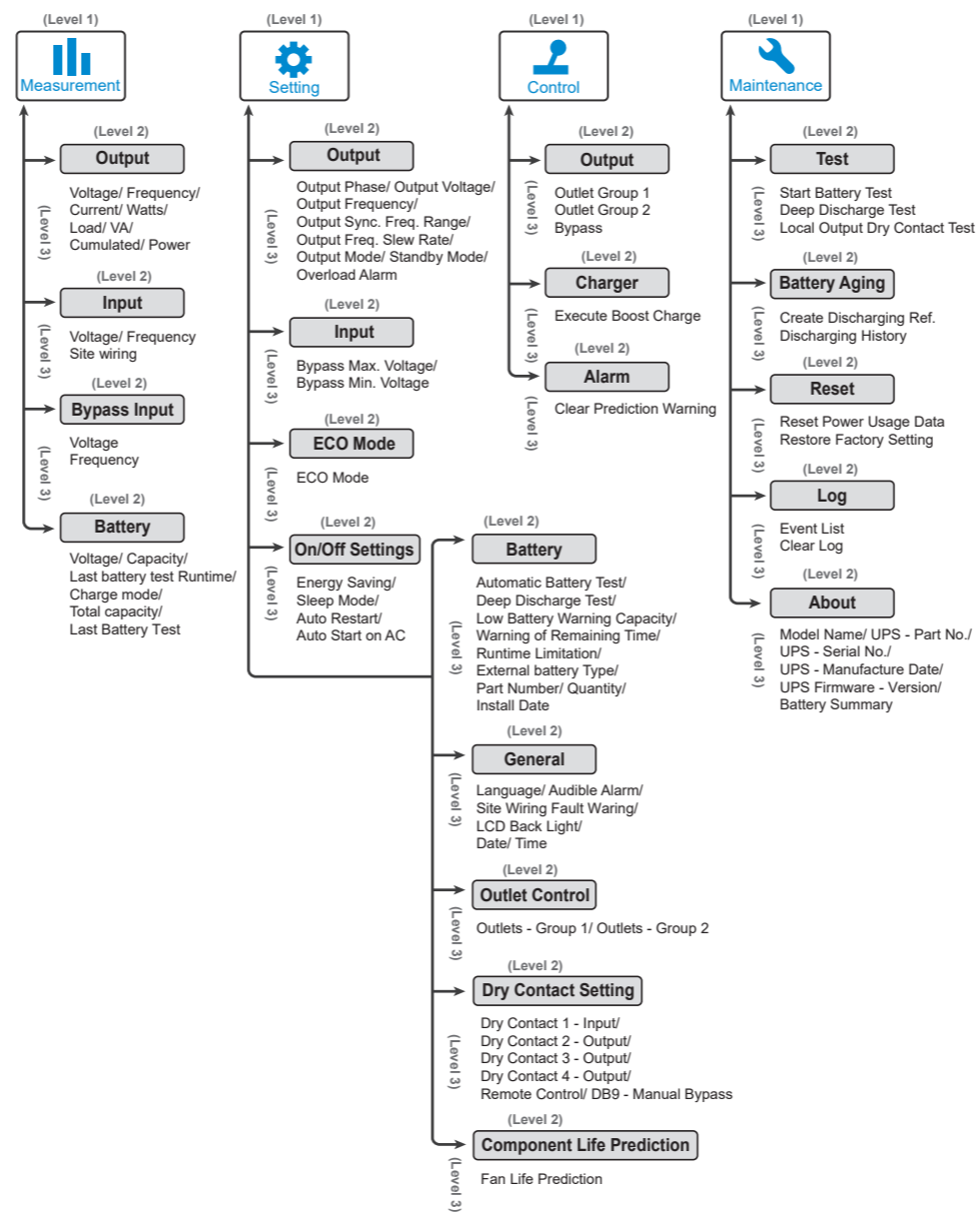
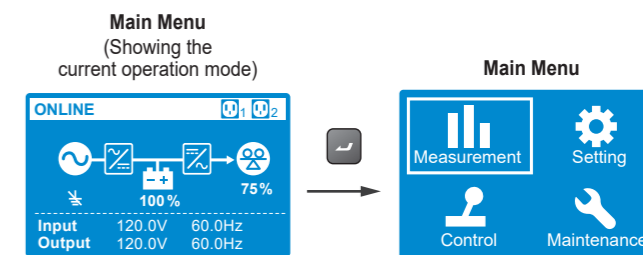













Figure 6.2.1 : Menu Tree

### 6.2.2 Setup Mode

For setup procedures, please refer to the following:



- In the **Main Menu**, select the item you want to configure, press the **ENTER** button (  ) for 0.1 second and the UPS will enter into the setup mode.
- Press the button (  ) for 0.1 second or press the button (  ) for 0.1 second to navigate the setting items.
- Press the button (  ) for 0.1 second to choose the parameter you want to change, and the parameter will flash.
- Press the button (  ) for 0.1 second or press the button (  ) for 0.1 second to increase or decrease the parameter value. If either of the buttons is pressed for over 2 seconds, the LCD will automatically switch between selectable values every 0.2 second until either of the buttons is released or the number has reached its highest or lowest value.
- Press the button (  ) to confirm your parameter setup or press the button (  ) to go back to the previous status.
- After that, press the button (  ) for 0.1 second or press the button (  ) for 0.1 second to move to the previous or the next setting item.
- In setup mode, press the (  ) button and the LCD will exit from the setup mode.
- In setup mode, if you don't press any button for more than 5 minutes, the LCD will exit from the setup mode and go back to the original display automatically.

Please refer to the **Menu Tree** in 6.2.1 for all setting options. With regards to the default values and selectable values of individual parameters in 'Setting Menu', please refer to the table below.

Setting Menu (Level 2)	Setup items (Level 3)	Selectable value	Default
Output	Output Phase	1-phase	1-phase
	Output Voltage	100V, 110V, 115V, 120V	120V
	Output Frequency	Auto*1/ Converter-50Hz*2/ Converter-60Hz*2	Auto
	Output Sync. Freq. Range	±0.5/ 1/ 3/ 5Hz	±3Hz
	Output Freq. Slew Rate	0.5/ 1/ 2/ 3/ 4Hz/ sec.	1 Hz/ sec.
	Output Mode	Industrial/ IT	IT
	Standby Mode	No output/ Bypass output	No output
	Overload Alarm	30-105% (5% one step)	105%

Setting Menu (Level 2)	Setup items (Level 3)	Selectable value	Default
Input	Bypass Max. Voltage	+10/ 15/ 20%	+15%
	Bypass Min. Voltage	-10/ 15/ 20/ 25/ 30/ 35/ 40%	-20%
ECO Mode	ECO Mode	Disable / Enable	Disable
	ECO Max. Voltage	5-15% (1% one step)	+10%
	ECO Min. Voltage	5-15% (1% one step)	-10%
On/Off settings	Energy Saving	Option 1 * <sup>3</sup> : Enable/ Disable Option 2: 1-15 mins (one step:1 min) Option 3: 100W-270W (one step: 10W)	Disable
	Sleep Mode	Option 1: Enable/ Disable Option 2: 10-120 mins (one step: 10 mins)	10mins
	Auto Restart	Enable/ Disable	Enable
	Auto Start on AC	Enable/ Disable	Disable
	Automatic Battery Test	No test/ Daily/ Weekly/ Biweekly/ Monthly	No test
Battery	Deep Discharge Test	20-90% (one step: 10%)	90%
	Low Battery Warning Capacity	0-95% (one step: 5%)	10%
	Warning of Remaining Time	0-60mins (one step: 1 min)	2mins
	Runtime Limitation	Disable/ 1/ 2/ 3.../ 240 (one step: 1 min)	Disable
	Internal Charging Current	Not adjustable	
	External Battery Type * <sup>4</sup>	Standard battery pack/ Customer own batt. pack	
	External Battery Capacity	<b>Standard battery pack:</b> Part Number Quantity <b>Customer own batt. pack:</b> Battery Voltage Total Capacity	
	Install date	YYYY/MM/DD	

Setting Menu (Level 2)	Setup items (Level 3)	Selectable value	Default	
General	Language	English/ 繁體中文	English	
	Audible Alarm	Enable/ Disable	Enable	
	Site Wiring Fault Wiring	Enable/ Disable	Enable	
	LCD Back Light	Always On/ Auto Off	Auto of	
	Date	YYYY/MM/DD		
	Time	HH:MM:SS		
Outlet Control	Outlets - Group 1	Output Reboot Duration	Disable/ 5/ 6/.../ 300 seconds (one step: 1 sec)	Disable
		Load Bank Runtime Limitation	Disable/ 1/ 2/.../ 240mins (step: 1 min)	Disable
	Outlets - Group 2	Output Reboot Duration	Disable/ 5/ 6/.../ 300 seconds (one step: 1 sec)	Disable
		Load Bank Runtime Limitation	Disable/ 1/ 2/.../ 240mins (step: 1 min)	Disable
Dry Contact settings	Dry Contact 1 - Input	Option 1* <sup>5</sup> : Disable/ ROO/ RPO (DC)/ Remote shutdown/ Forced bypass/ On generator Option 2: 0-999s (step: 1 sec) Option 3: Normal open/ Normal close	ROO/ 10s	
	Dry Contact 2 - Output	Disable/ On bat/ Low bat/ Bat fault/ Bypass/ UPS OK/ Load protected/ Load powered/ General alarm/ Overload alarm	On batt.	
	Dry Contact 3 - Output	Disable/ On bat/ Low bat/ Bat fault/ Bypass/ UPS OK/ Load protected/ Load powered/ General alarm/ Overload alarm	Low batt.	
	Dry Contact 4 - Output	Disable/ On bat/ Low bat/Bat fault/ Bypass/ UPS OK/ Load protected/ Load powered/ General alarm/ Overload alarm	General alarm	
	Remote Control	Option 1: REPO/ ROO		REPO/ NO
		Option 2: Normal open/ Normal close (For REPO)	Option 2: delay time 0-999 sec (step: 1 sec) (For ROO)	
	DB9 - Manual Bypass	Enable/ Disable		Disable
Component Life Prediction	Fan Life Prediction	No/ Yes	No	



**NOTE:**

- \*<sup>1</sup> When the **Output Frequency** is set as **Auto**, the output frequency will vary according to the bypass frequency.  
If the bypass frequency is  $\geq 55\text{Hz}$ , the **Free\_Run\_Frequency/ Cold\_Start\_Frequency** will be set as 60Hz.  
If the bypass frequency is  $< 55\text{Hz}$ , the **Free\_Run\_Frequency/ Cold\_Start\_Frequency** will be set as 50Hz.
- When the **Output Frequency** is set as **Auto** and the **Bypass Output** under the **Standby Mode** item is set as **Enable**, the bypass output range will be the same as the **Output Sync. Freq. Range**.
- \*<sup>2</sup> When the **Output Frequency** is set as **Converter-50Hz/ Converter-60Hz**, the UPS will enter into **Frequency Conversion** mode and the bypass output will become **Disable**.
- \*<sup>3</sup> In **Setting Menu**, the sub item **Option 1** under the item **Energy Saving** cannot be changed.
- \*<sup>4</sup> When the **External Battery Type** is set as **Standard battery pack**, you need to configure the **Part Number** and the **Quantity** of the standard battery pack(s).

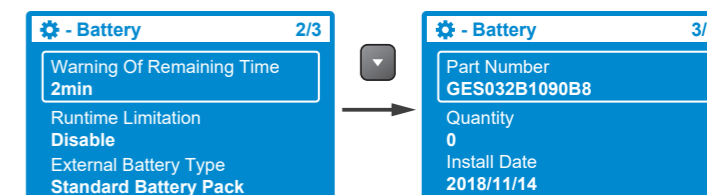

When the **External Battery Type** is set as **Customer own batt. pack**, the **Part Number** and **Quantity** will be changed accordingly to **Battery Voltage** and **Total Capacity**.

- \*<sup>5</sup> For detailed information about **Option 1** in dry contact settings, please contact service personnel.

**6.3 LCD Display**

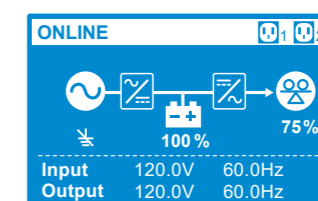

**6.3.1 Icon/ Display Definition**

No.	Icon(s)	Description
1		There is output for the Load 1 and Load 2.
		Indicates the output status for the connected loads. When there is output, the load's icon will light up. When there is no output, the load's icon will light up with a backslash.
		There is output for the Load 1, but there is no output for the Load 2.
		There is no output for the Load 1, but there is output for the Load 2.
2		There is no output for either the Load 1 or the Load 2.
		Indicates the Site Wiring Fault status. <b>ON:</b> There is Site Wiring Fault. <b>OFF:</b> There is no Site Wiring Fault.

No.	Icon(s)	Description
3		Indicates the battery capacity level (%).
		When there is no battery pack connected to the UPS, this icon will flash.
		Indicates that battery is bad and needs replacement.
4		Indicates the load level (%).
5		When the UPS runs normally, this display will show the input/output voltage and frequency.
		When the UPS has abnormalities or is at fault condition, this display will show an error code and its corresponding fault or warning message. <b>NOTE:</b> The error code and the fault/ warning message will appear alternatively for every 5 seconds.
6		Indicates that the buzzer is muted.

### 6.3.2 Operation Mode Diagram Definition

No.	Diagram	Description
1		Indicates <b>ONLINE</b> mode.
2		Indicates <b>ECO</b> mode. <b>NOTE:</b> In <b>ECO</b> mode, the diagram's power flow will change according to the UPS input voltage and frequency. However, the <b>ECO</b> icon shown on the upper-left corner will not change even if the UPS transfers to online mode or battery mode.
3		Indicates <b>BATTERY</b> mode. <b>NOTE:</b> The error code and the fault/ warning message will appear alternatively for every 5 seconds.
4		Indicates <b>BYPASS</b> mode.
5		Indicates <b>Frequency Conversion</b> mode. <b>NOTE:</b> In <b>Frequency Conversion</b> mode, the diagram's power flow will change according to the UPS input voltage and frequency. However, the <b>Freq. Conv.</b> icon shown on the upper-left corner will not change even if the UPS transfers to battery mode.

No.	Icon(s)	Description
6		Indicates <b>AC standby</b> mode.
7		Indicates <b>DC standby</b> mode. <b>NOTE:</b> The error code and the fault/ warning message will appear alternatively for every 5 seconds.

### 7 Turn-on/ Turn-off Procedures

Turn-on Procedures	Turn-off Procedures
<ul style="list-style-type: none"> <li><b>Start-up with AC Input:</b> <b>If you don't connect the Delta external battery pack(s) to the UPS:</b> <ol style="list-style-type: none"> <li>Verify if the UPS's input cord meets with N, L &amp; G of the wall socket.</li> <li>Plug the UPS's input cord into the wall socket.</li> <li>Press and hold the  button for 3 seconds and release it after you hear one beep.</li> <li>The UPS performs self-diagnosis and then the UPS will run in ON-LINE mode.</li> </ol> </li> <li><b>If you connect the Delta external battery pack(s) to the UPS:</b> <ol style="list-style-type: none"> <li>Verify if the UPS's input cord meets with N, L &amp; G of the wall socket.</li> <li>Check the '+' and '-' poles of the Delta external battery pack(s) and ensure that wiring is correct.</li> <li>Connect the Delta external battery pack(s) to the UPS.</li> <li>Plug the UPS's input cord into the wall socket.</li> <li>Press and hold the  button for 3 seconds and release it after you hear one beep.</li> <li>The UPS performs self-diagnosis and then the UPS will run in ON-LINE mode.</li> </ol> </li> <li><b>Start-up with Battery (Cold-start)</b> <ol style="list-style-type: none"> <li>When there is no AC utility input, you can still turn on the UPS.</li> <li>Just press the  button for 3 seconds and release the button after you hear on beep. The UPS performs self-diagnosis and then the UPS will run in Battery mode.</li> </ol> </li> </ul>	<ol style="list-style-type: none"> <li>Make sure all loads connected to the UPS have been completely shut down.</li> <li>Press and hold the  button for 3 seconds, and release it after you hear one beep.</li> <li>Disconnect the UPS from the AC power.</li> <li>If you connect the external battery pack(s) to the UPS, disconnect the UPS from the external battery pack(s).</li> </ol>

**NOTE:** For more information about the connections of the external battery pack(s). Please refer to the **User Manual for Delta Amplon RT 1/ 1.5/ 2/ 3 kVA UPS.**

### 8 Troubleshooting

When you see the following problems occur, please follow the solutions shown below.

Error Code	Meaning	Possible Cause	Solution
0X8221	DC Bus Over Shutdown - Positive	1. Output has capacitive load or inductive load. 2. The UPS has an internal fault.	1. Remove the capacitive or inductive loads. 2. Please contact service personnel.

Error Code	Meaning	Possible Cause	Solution
0X8241	DC Bus Over Shutdown - Negative	1. Output has capacitive load or inductive load. 2. The UPS has an internal fault.	1. Remove the capacitive or inductive loads. 2. Please contact service personnel.
0X82A1	DC Bus Under Shutdown - Positive	The UPS has an internal fault.	Please contact service personnel.
0X82C1	DC Bus Under Shutdown - Negative	The UPS has an internal fault.	Please contact service personnel.
0x1200	INV Volt Abnormal	The UPS has an internal fault.	Please contact service personnel.
0x1101	Output Overload Shutdown	The UPS is overloaded.	Check the power consumption of the load, and remove the unnecessary loads.
0xA000	Charger Fault	The UPS has an internal fault.	Please contact service personnel.
0X2402	INV IGBT Over Heat Shutdown	1. The vents are blocked. 2. The UPS has an internal fault.	1. Check whether the vents are blocked. 2. Contact service personnel.
0X2402	PFC Over Heat Shutdown	1. The vents are blocked. 2. The UPS has an internal fault.	1. Check whether the vents are blocked. 2. Contact service personnel.
0x1003	Battery Disconnected	1. The UPS is not properly connected to the external battery pack(s). 2. The battery/ batteries is (are) damaged.	1. Check whether the UPS is properly connected to the external battery pack(s). 2. Contact service personnel.

**NOTE:** If all possible causes are eliminated but the alarm still appears, please contact your local dealer or customer service.

### 9 Optional Accessories

No.	Item	Function
1	Dust Filter(s)	Prevent(s) dust from entering into the UPS to ensure UPS reliability and to prolong product life.
2	Hot-swappable Mini SNMP IPv6 Card	Monitors and controls the status of the UPS via a network system.
3	Hot-swappable Mini Relay I/O Card	Increases the quantity of dry contacts.
4	Hot-swappable Mini MODBUS Card	Lets the UPS have MODBUS communication function.
5	External Battery Pack	Provides external batteries to let the UPS continue supplying power to its connected loads when a power outage occurs.
6	External Maintenance Bypass Box	Lets the connected critical loads continue to be powered by the input power during UPS maintenance or during the unlikely event of a UPS failure.

**NOTE:** For more details, please contact your local dealer or customer service.



## 10 Technical Specifications

Model		RT-1K	RT-1.5K	RT-2K	RT-3K
<b>Power Rating*1</b>		1kVA/0.9kW	1.5kVA/1.35kW	2kVA/1.8kW	3kVA/2.7kW
<b>Waveform</b>		Pure Sine Wave			
<b>Input</b>	Nominal Voltage	100/110/115/120 Vac			
	Voltage Range	1. 110/115/120 Vac: 100~150 Vac (full load) & 55~100 Vac (50%~100% linear load) 2. 100Vac: 90~150 Vac (full load) & 55~90 Vac (50%~100% linear load)			
	Frequency	40 ~ 70 Hz			
	Power Factor	> 0.99 (full load)			
	iTHD	< 5%			
<b>Output</b>	Power Factor	0.9			
	Voltage	100/110/115/120 Vac			
	Voltage Regulation	± 1% (linear load)			
	Frequency	50/60 Hz (± 0.05 Hz)			
	vTHD	< 3% (linear load); < 4% (non-linear load)			
	Overload Capability	≤ 105%: Continuous > 105% ~ ≤ 125%: 2 minutes > 125% ~ ≤ 150%: 30 seconds > 150%: 500 msec			
	Cress Factor	3:1			
	Connection	<b>Load bank 1</b> (relay controlled): 5-15R x 3  <b>Load bank 2</b> (relay controlled): 5-15R x 3  <b>Load bank 3:</b> 5-15R x 2	<b>Load bank 1</b> (relay controlled): 5-15R x 3  <b>Load bank 2</b> (relay controlled): 5-15R x 3  <b>Load bank 3:</b> 5-15R x 2	<b>Load bank 1</b> (relay controlled): 5-15/20R x 4  <b>Load bank 2</b> (relay controlled): 5-15/20R x 4  <b>Load bank 3:</b> L5-20R x 1	<b>Load bank 1</b> (relay controlled): 5-15/20R x 4 with 20A 120 Vac 1P branch breaker  <b>Load bank 2</b> (relay controlled): 5-15/20R x 4 with 20A 120 Vac 1P branch breaker  <b>Load bank 3:</b> L5-30R x 1
<b>Efficiency*2</b>	Online Mode	91.5%	92.5%	93%	93%
	ECO Mode	98%	98.5%	98.5%	98.5%

Model		RT-1K	RT-1.5K	RT-2K	RT-3K
<b>Battery &amp; Charger</b>	Battery Voltage	24 Vdc	36 Vdc	48 Vdc	72 Vdc
	Battery Type	12V/9 Ah Sealed lead-acid battery			
	Backup Time (100%/75% load)	4/6.5 minutes			
	Charge Current	1A			
Recharge Time	3 hours to 90%				
<b>Audible Noise*3</b>		< 40 dB	< 40 dB	< 45 dB	< 45 dB
<b>Display</b>		Graphical and multi-lingual LCD			
<b>Communication Interfaces</b>		Mini Slot x 1, RS-232 Port x 1, USB Port x 1, REPO/ ROO x 1, Dry Contact x 4			
<b>Physical</b>	Dimensions (W x D x H)	440 x 335 x 88.2 mm (17.3 x 13.2 x 3.5 inch)	440 x 430 x 88.2 mm (17.3 x 16.9 x 3.5 inch)	440 x 430 x 88.2 mm (17.3 x 16.9 x 3.5 inch)	440 x 565 x 88.2 mm (17.3 x 22.2 x 3.5 inch)
	Weight	12.4 kg (27.3 lb)	17.7 kg (39.0 lb)	20.8 kg (45.9 lb)	30 kg (66.1 lb)
<b>Environment</b>	Operating Altitude	0 ~ 3000m (0 ~ 10000 ft); 0 ~ 1000m (0 ~ 3300 ft) (without derating)			
	Operating Temperature	0 ~ 40°C (32 ~ 104°F)*4			
	Relative Humidity	0 ~ 95% RH (non-condensing)			

### NOTE:

- \*1 To comply with UL, the UPS capacity will be de-rated at 100/110/115 Vac due to power cord's current limitation.
- \*2 Power loss from the input and output power cords is not included.
- \*3 At typical environment temperature ≤ 30°C.
- \*4 When the operating temperature is at 40 ~ 50°C (104 ~ 122°F), the UPS will be de-rated to 80% of its capacity.
- Refer to the rating label for the safety rating.
- All specifications are subject to change without prior notification.

Copyright © 2018 by Delta Electronics Inc. All rights reserved.  
Changes may be made periodically to the information in this Quick Guide without obligation to notify any person of such revision or changes.

No. 501326740001  
Version : V 0.1  
Release Date : 2018\_11\_26