

Antenna

YEWN001AA Datasheet

Antenna Services

Version: 1.3

Date: 2022-10-17

Status: Released



At Quectel, our aim is to provide timely and comprehensive services to our customers. If you require any assistance, please contact our headquarters:

Quectel Wireless Solutions Co., Ltd.

Building 5, Shanghai Business Park Phase III (Area B), No.1016 Tianlin Road, Minhang District, Shanghai 200233, China

Tel: +86 21 5108 6236

Email: info@quectel.com

Or our local offices. For more information, please visit:

<http://www.quectel.com/support/sales.htm>.

For technical support, or to report documentation errors, please visit:

<http://www.quectel.com/support/technical.htm>.

Or email us at: support@quectel.com.

Legal Notices

We offer information as a service to you. The provided information is based on your requirements and we make every effort to ensure its quality. You agree that you are responsible for using independent analysis and evaluation in designing intended products, and we provide reference designs for illustrative purposes only. Before using any hardware, software or service guided by this document, please read this notice carefully. Even though we employ commercially reasonable efforts to provide the best possible experience, you hereby acknowledge and agree that this document and related services hereunder are provided to you on an “as available” basis. We may revise or restate this document from time to time at our sole discretion without any prior notice to you.

Use and Disclosure Restrictions

License Agreements

Documents and information provided by us shall be kept confidential, unless specific permission is granted. They shall not be accessed or used for any purpose except as expressly provided herein.

Copyright

Our and third-party products hereunder may contain copyrighted material. Such copyrighted material shall not be copied, reproduced, distributed, merged, published, translated, or modified without prior written consent. We and the third party have exclusive rights over copyrighted material. No license shall be granted or conveyed under any patents, copyrights, trademarks, or service mark rights. To avoid ambiguities, purchasing in any form cannot be deemed as granting a license other than the normal non-exclusive, royalty-free license to use the material. We reserve the right to take legal action for noncompliance with abovementioned requirements, unauthorized use, or other illegal or malicious use of the material.

Trademarks

Except as otherwise set forth herein, nothing in this document shall be construed as conferring any rights to use any trademark, trade name or name, abbreviation, or counterfeit product thereof owned by Quectel or any third party in advertising, publicity, or other aspects.

Third-Party Rights

This document may refer to hardware, software and/or documentation owned by one or more third parties (“third-party materials”). Use of such third-party materials shall be governed by all restrictions and obligations applicable thereto.

We make no warranty or representation, either express or implied, regarding the third-party materials, including but not limited to any implied or statutory, warranties of merchantability or fitness for a particular purpose, quiet enjoyment, system integration, information accuracy, and non-infringement of any third-party intellectual property rights with regard to the licensed technology or use thereof. Nothing herein constitutes a representation or warranty by us to either develop, enhance, modify, distribute, market, sell, offer for sale, or otherwise maintain production of any our products or any other hardware, software, device, tool, information, or product. We moreover disclaim any and all warranties arising from the course of dealing or usage of trade.

Privacy Policy

To implement module functionality, certain device data are uploaded to Quectel’s or third-party’s servers, including carriers, chipset suppliers or customer-designated servers. Quectel, strictly abiding by the relevant laws and regulations, shall retain, use, disclose or otherwise process relevant data for the purpose of performing the service only or as permitted by applicable laws. Before data interaction with third parties, please be informed of their privacy and data security policy.

Disclaimer

- a) We acknowledge no liability for any injury or damage arising from the reliance upon the information.
- b) We shall bear no liability resulting from any inaccuracies or omissions, or from the use of the information contained herein.
- c) While we have made every effort to ensure that the functions and features under development are free from errors, it is possible that they could contain errors, inaccuracies, and omissions. Unless otherwise provided by valid agreement, we make no warranties of any kind, either implied or express, and exclude all liability for any loss or damage suffered in connection with the use of features and functions under development, to the maximum extent permitted by law, regardless of whether such loss or damage may have been foreseeable.
- d) We are not responsible for the accessibility, safety, accuracy, availability, legality, or completeness of information, advertising, commercial offers, products, services, and materials on third-party websites and third-party resources.

Copyright © Quectel Wireless Solutions Co., Ltd. 2022. All rights reserved.

About the Document

Revision History

Version	Date	Author	Note
-	2021-05-11	Kenny YIN/ Aria CHU	Creation of the document
1.0	2021-05-11	Kenny YIN/ Aria CHU	First official release
1.1	2021-07-25	Kenny YIN/ Aria CHU	Updated working temperature (Chapter 3).
1.2	2021-11-30	Kenny YIN/ Aria CHU	Updated the product description in Chapter 1.
1.3	2022-10-17	Aria CHU	Deleted the IP rating.

Contents

About the Document.....	3
Contents.....	4
1 Product Description.....	5
2 Product Features	5
3 Product Specifications	6
4 Overall Performance.....	7
4.1. Test Environment	7
4.2. VSWR.....	8
4.3. Efficiency	8
4.4. Gain.....	9
4.5. Radiation Pattern	10
4.5.1. 2400 MHz	10
4.5.2. 2450 MHz	11
4.5.3. 2500 MHz	11
4.5.4. 5150 MHz	12
4.5.5. 5350 MHz	13
4.5.6. 5750 MHz	13
4.5.7. 5850 MHz	14
5 Product Size	15

1 Product Description

Quectel Wi-Fi antenna covers 2.4 GHz, 5 GHz, and up to 7 GHz bands, fully satisfying customers' requirements for Wi-Fi 5, Wi-Fi 6, and Wi-Fi 6E. There are various antenna types, including built-in FPC antenna, ceramic patch antenna, and other external antennas of different shapes or sizes. The antenna performance meets the customers' demands for efficiency, gain, and radiation and ensures the superior experience of the customers' products in use.

We provide comprehensive antenna design support such as simulation, testing and manufacturing for custom antenna solutions to meet your specific application needs.

2 Product Features

- Wi-Fi 6 2.4/5.8 GHz
- High efficiency
- Excellent performance



3 Product Specifications

Passive Electrical Specifications

Frequency Range	2400–2500 MHz, 5150–5850 MHz
Input Impedance	50 Ω
VSWR	≤ 2.0
Gain	≤ 5.0 dBi
Polarization Type	Linear

Mechanical Specifications

Antenna Size	Φ 13 mm x 200 mm
Casing	TPEE
Connector Type	RP-SMA Male (Center Receptacle)
Working Temperature	-40 °C to +85 °C
Radome Color	Black

4 Overall Performance

4.1. Test Environment

- KEYSIGHT VNA Network Analyzer E5063A 100 kHz – 8.5 GHz
- RayZone® 2800 Chamber 5G (FR1) SISO/MIMO, 400 MHz – 8.0 GHz



4.2. VSWR

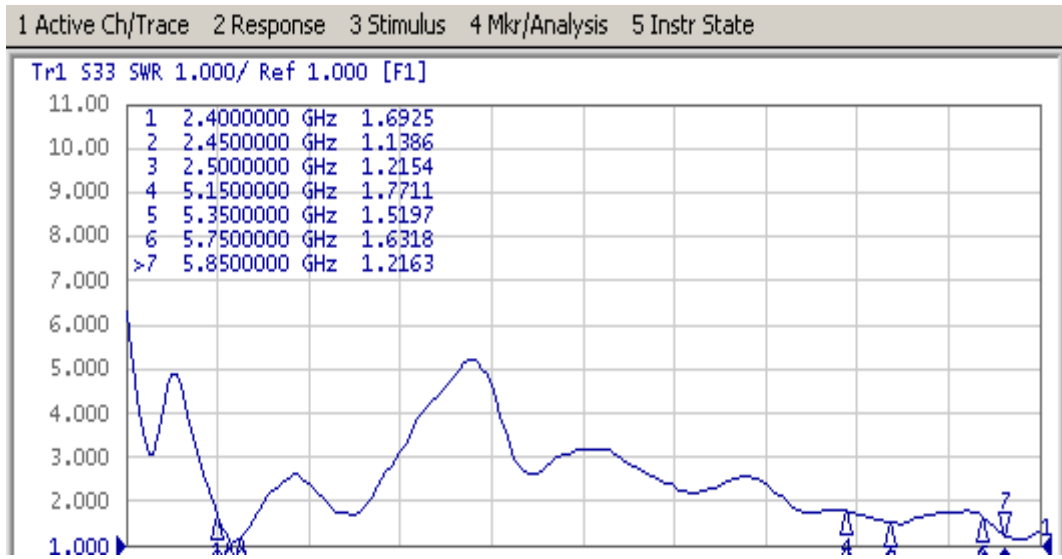

Frequency (MHz)	2400	2450	2500	5150	5350	5750	5850
VSWR	1.69	1.13	1.21	1.77	1.51	1.63	1.21

4.3. Efficiency

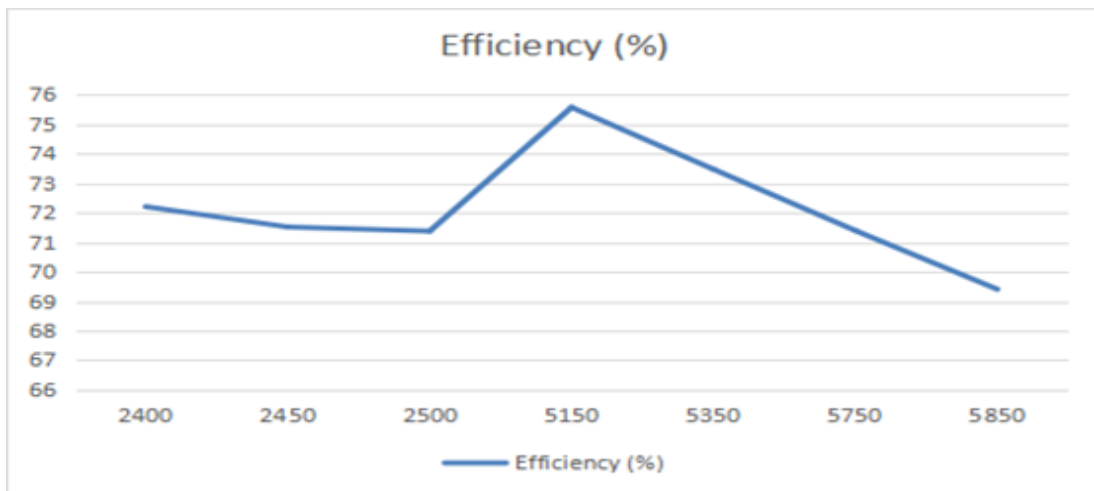

Frequency (MHz)	2400	2450	2500	5150	5350	5750	5850
Efficiency (%)	72.21	71.52	71.38	75.58	73.48	71.4	69.41

4.4. Gain

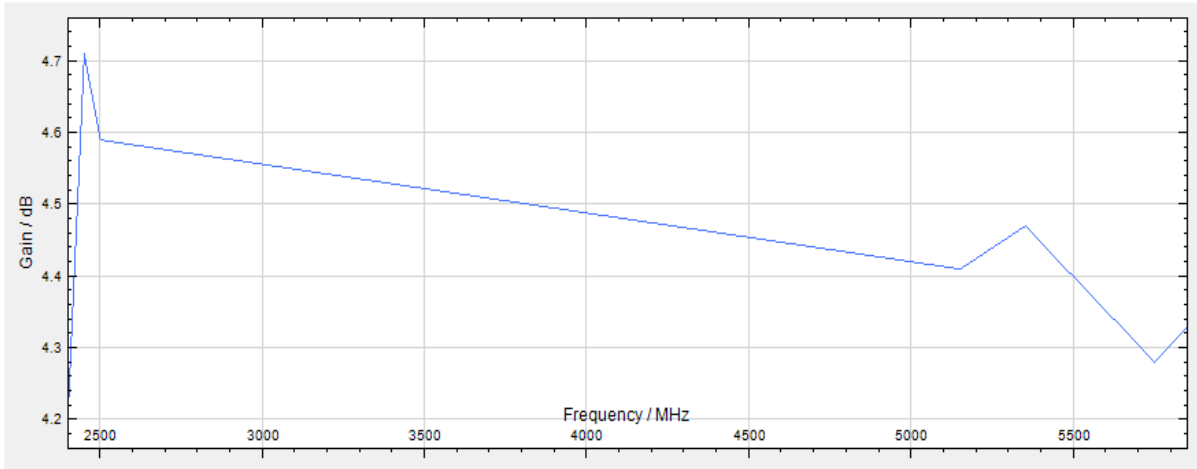

Frequency (MHz)	2400	2450	2500	5150	5350	5750	5850
Gain (dBi)	4.21	4.71	4.59	4.41	4.47	4.28	4.33

4.5. Radiation Pattern

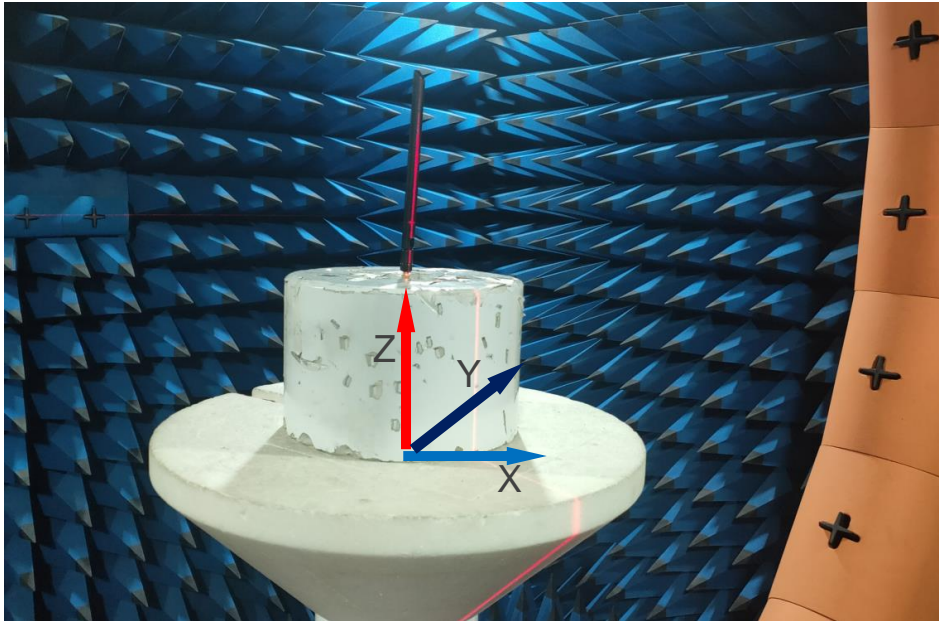

4.5.1. 2400 MHz

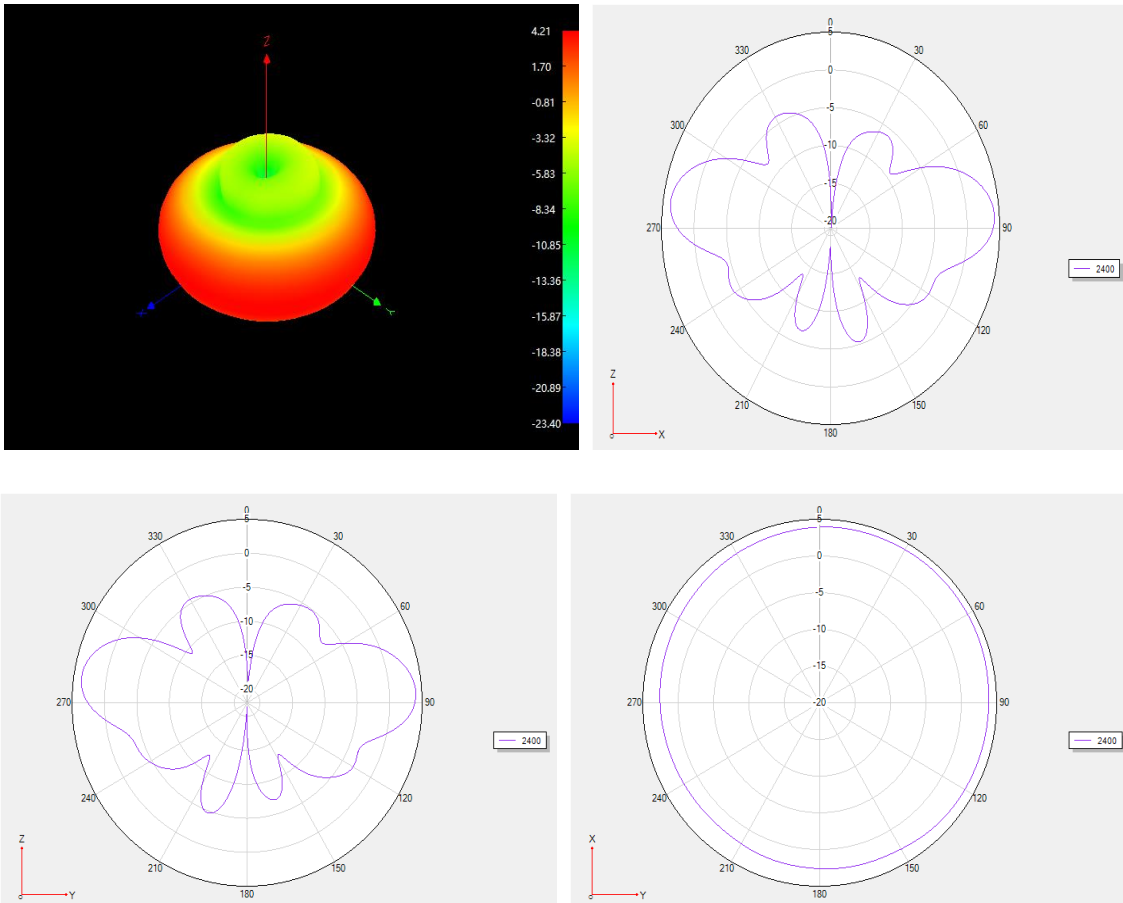

4.5.2. 2450 MHz

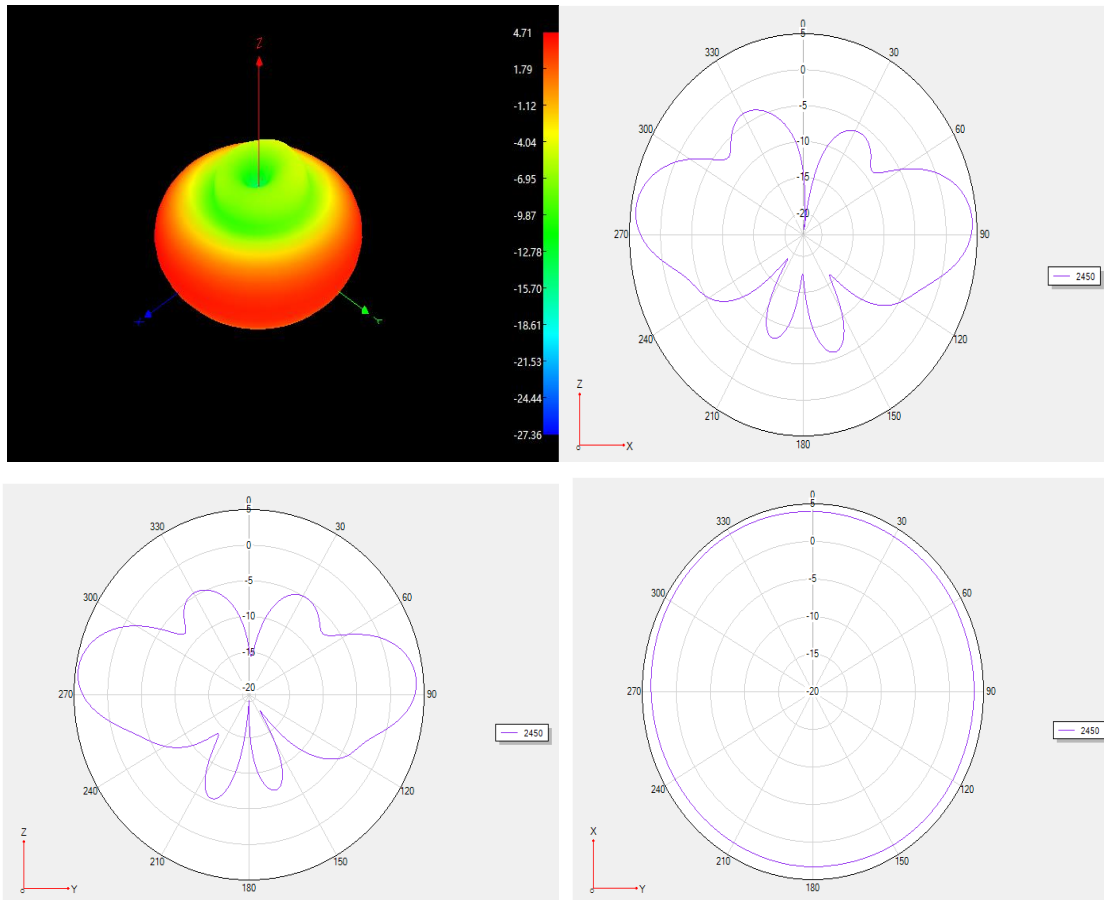

4.5.3. 2500 MHz

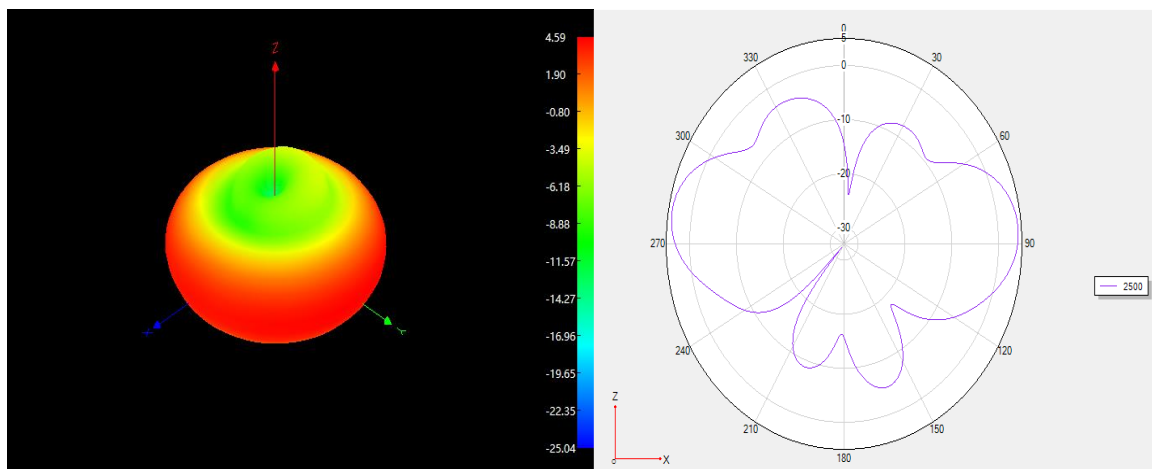

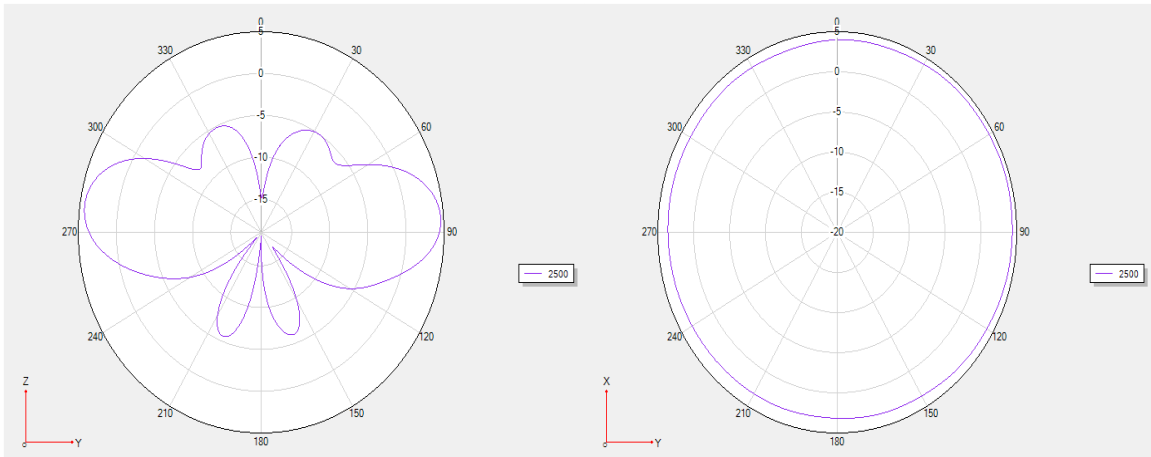

4.5.4. 5150 MHz

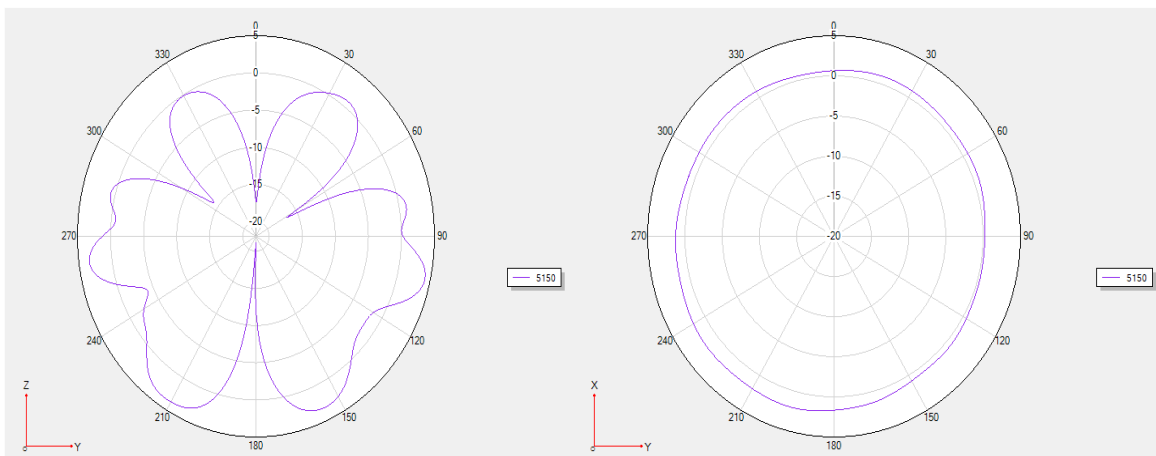
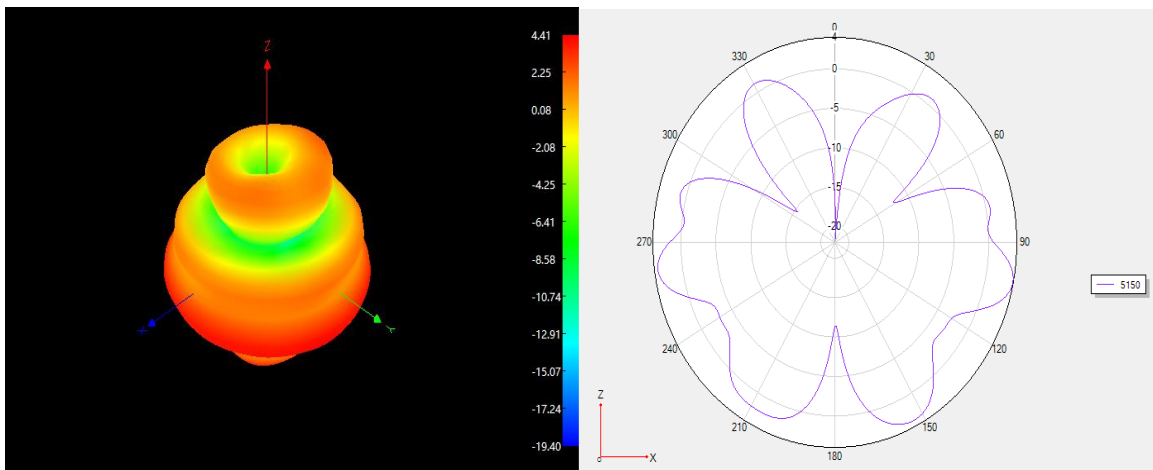

4.5.5. 5350 MHz

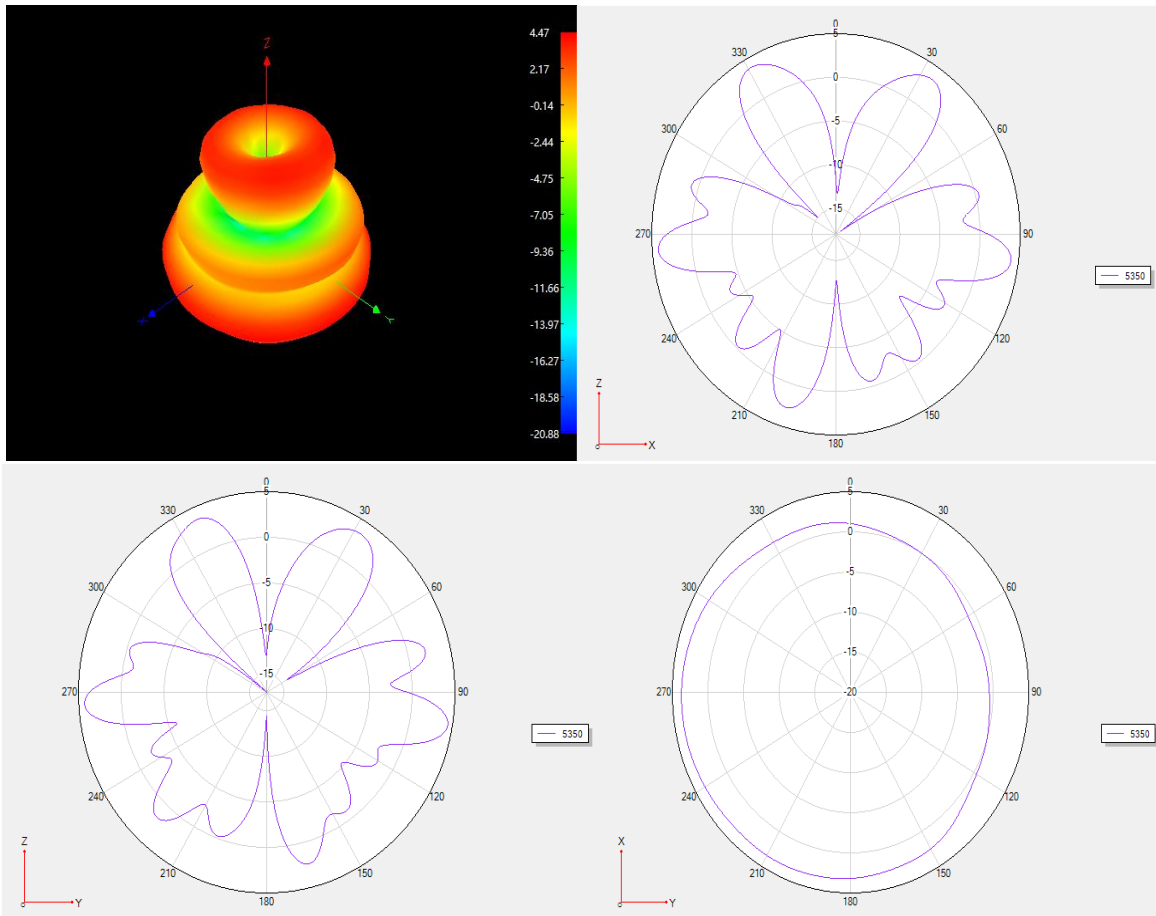

4.5.6. 5750 MHz

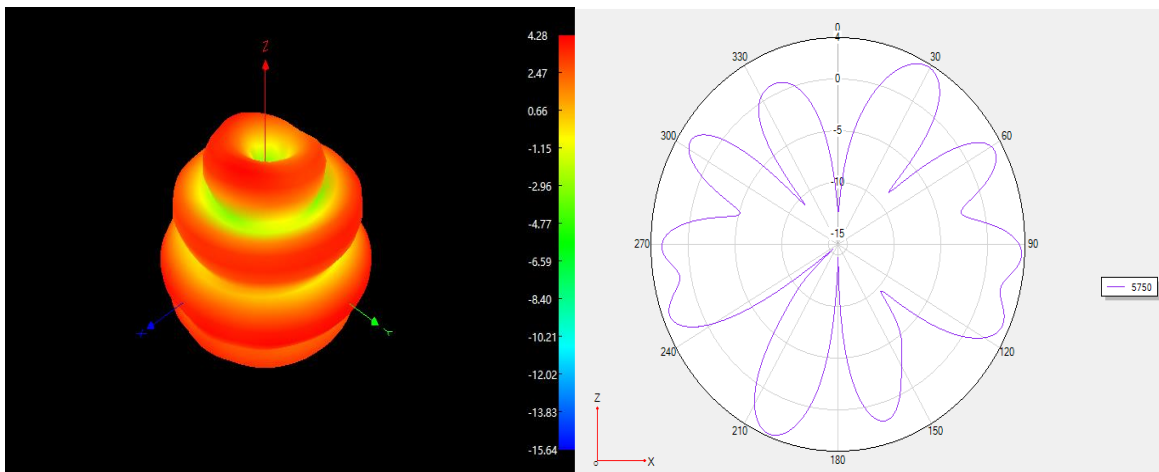

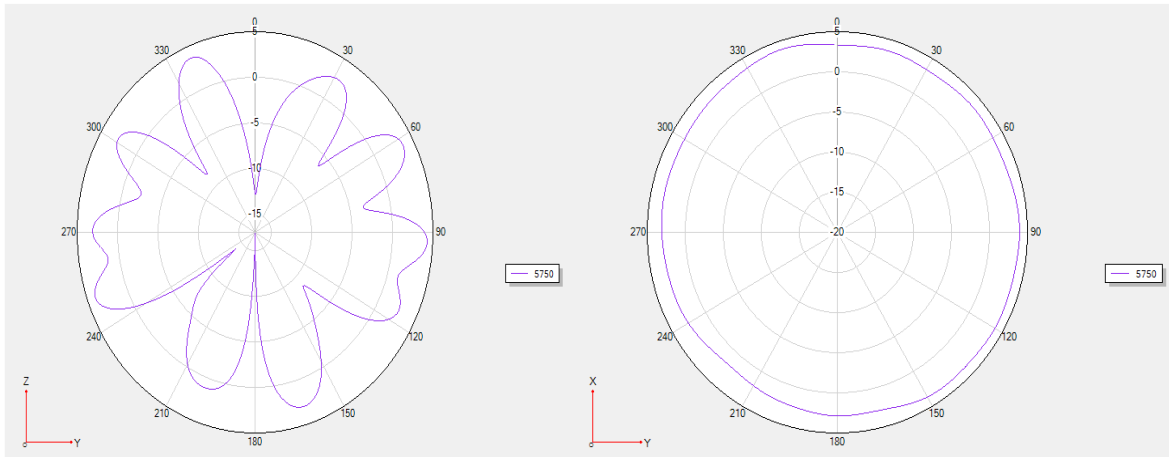

4.5.7. 5850 MHz

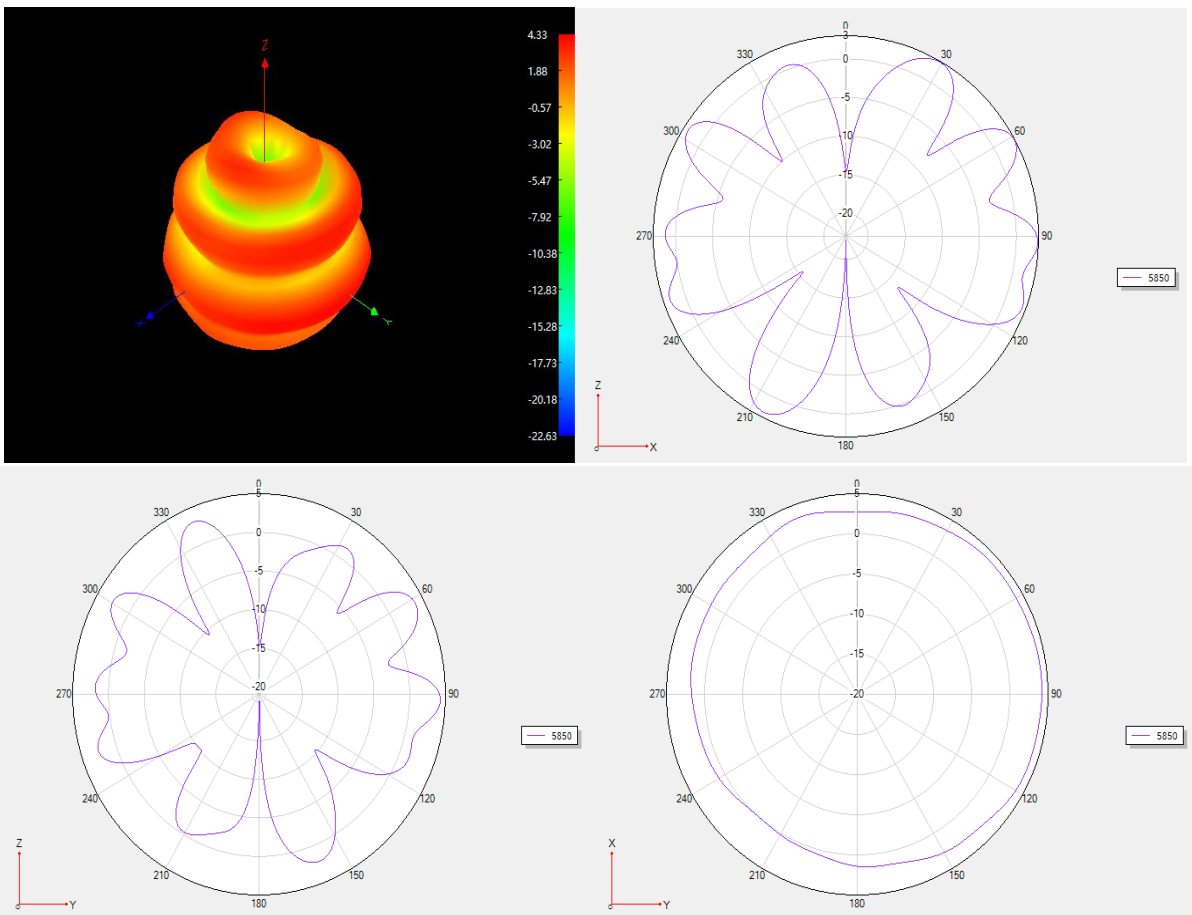

5 Product Size

