

Lead Type Capacitors with Varistor Function

VFC2 H□□□□□□□K□□□□

Murata Reference Specification [AEC-Q200]

1.Scope

This reference specification applies to Lead Type Capacitors With Varistor Function for Automotive Electronics based on AEC-Q200.

2.Part Numbering

V F	C	2	H	R 7	1 D	1 0 5	K	2	K 1	A
	①	②	③	④	⑤	⑥	⑦	⑧	⑨	⑩

① Structure C : Capacitors with Varistor Function

② Style 2:2012Size

③ Features

④ Temperature Characteristics

⑤ Rated Voltage

⑥ Capacitance

□	□	□
↓		

Marked three digits system.(Ex. 1.0pF→105)

⑦ Capacitance Tolerance

⑧ Varistor Voltage (1 : 2 2 V、 2 : 27V、 3 : 3 3 V、 4 : 4 7 V、 5 : 6 8 V、 6 : 8 2 V)

⑨ Lead Type

⑩ Packaging Code A : Ammo Pack / B : Bulk

3.Rating

Customer Part Number	Part Number	Capacitance value ,Tolerance	Temperature Characteristics	Rated Voltage (DC)	Varistor Voltage (V _{1mA})	Voltage Ratio (V _{1mA} / V _{0.1mA})				
	VFC2HL81C474K1M1A	470nF±10%	±15% (~125°C)	16V	22V +5/-0V	1.17max.				
	VFC2HL81C474K1K1B					1.12max.				
	VFC2HL81C105K1M1A	1.0uF±10%				+15%/-40% (125°C~150°C)	22V	27V +5/-3V	1.17max.	
	VFC2HL81C105K1K1B								1.12max.	
	VFC2HL81D474K2M1A	470nF±10%		±15%	22V				27V +5/-3V	1.17max.
	VFC2HL81D474K2K1B									1.12max.
	VFC2HL81D105K2M1A	1.0uF±10%	±15%				22V	27V +5/-3V		1.17max.
	VFC2HL81D105K2K1B									1.12max.
	VFC2HR71C474K1M1A	470nF±10%			±15%	16V			22V +5/-0V	1.17max.
	VFC2HR71C474K1K1B									1.12max.
	VFC2HR71C105K1M1A	1.0uF±10%		±15%			22V	27V +5/-3V		1.17max.
	VFC2HR71C105K1K1B									1.12max.
	VFC2HR71D474K2M1A	470nF±10%	±15%			26V			33V +6/-0V	1.17max.
	VFC2HR71D474K2K1B									1.12max.
	VFC2HR71D105K2M1A	1.0uF±10%			±15%		26V	33V +6/-0V		1.17max.
	VFC2HR71D105K2K1B									1.12max.
	VFC2HR71E474K3M1A	470nF±10%		±15%		26V			33V +6/-0V	1.12max.
	VFC2HR71E474K3K1B									1.10max.
	VFC2HR71E105K3M1A	1.0uF±10%	±15%				26V	33V +6/-0V		1.12max.
	VFC2HR71E105K3K1B									1.10max.

Customer Part Number	Part Number	Capacitance value ,Tolerance	Temperature Characteristics	Rated Voltage (DC)	Varistor Voltage (V _{1mA})	Voltage Ratio (V _{1mA} / V _{0.1mA})	
	VFC2HR71F474K4M1A	470nF±10%	±15%	34V	47V +7/-7V	1.12max.	
	VFC2HR71F474K4K1B					1.10max.	
	VFC2HR71F105K4M1A	1.0uF±10%		56V	68V +4/-6V	1.07max.	
	VFC2HR71F105K4K1B					1.06max.	
	VFC2HR71H104K5M1A	100nF±10%		65V	82V +8/-8V	1.06max.	
	VFC2HR71H104K5K1B					1.07max.	
	VFC2HR71J104K6M1A	100nF±10%					1.06max.
	VFC2HR71J104K6K1B						1.07max.

- Operating Temperature • Storage Temperature
 -55~+150°C (VFC2HL8 Series)
 -55~+125°C (VFC2HR7 Series)

- Insulation Resistance
 1MΩ min

- Maximum Peak Current
 200A (except VFC2HR71J104K6)
 160A (for VFC2HR71J104K6)

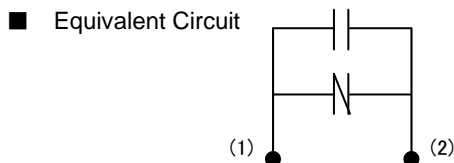

- Unit Mass (Typical value) 0.16g

4.Style and Dimensions
 See item 10.

5.Marking

- Capacitance : Marked three digits system. (105)
- Capacitance Tolerance : Marked with code (K)
- Varistor Voltage : Marked with code (2)
- Trade Mark : Marked as

6.Testing Condition

- | | |
|--|--------------------------------------|
| <Unless otherwise specified> | <In case of doubt> |
| Temperature : Ordinary Temperature 15 to 35 °C | Temperature : 20±2°C |
| Humidity : Ordinary Humidity 25 to 85%(RH) | Humidity : 60 to 70% |
| | Atmospheric Pressure : 86 to 106 kPa |

7. Electrical Performance

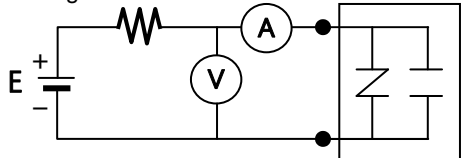
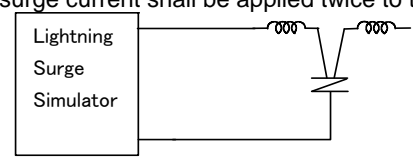
No.	Item	Specification	Test Method																																						
7.1	Style and Dimension	Meet item 9.	Visual Inspection and measured with Slide Calipers.																																						
7.2	Marking	Marking is able to be read easily.	Visual Inspection.																																						
7.3	Capacitance and Tolerance	Meet item 3.	Frequency : 1 ± 0.1 kHz Test Voltage : 1 ± 0.2 V(rms)																																						
7.4	Insulation Resistance(I.R.)		Test Voltage : Rated Voltage Time : 30 ± 5 minutes through a suitable resistor $1M\Omega$.																																						
7.5	Varistor Voltage		Measuring Current : 1 mA 																																						
7.6	Resistance to Surge Current	Meet Table 1.	The surge current shall be applied twice to them.  Wave form : $8/20 \mu s$ Peak current : 200A (for VFC2HR71J104K6 :160A) The number of Times : 2 times (5 minutes interval)																																						
		Table 1																																							
		<table border="1" style="width: 100%; border-collapse: collapse;"> <tr> <td style="width: 30%;">Appearance</td> <td>No damaged.</td> </tr> <tr> <td>Varistor Voltage Change</td> <td>within $\pm 10\%$</td> </tr> </table>	Appearance	No damaged.	Varistor Voltage Change	within $\pm 10\%$																																			
Appearance	No damaged.																																								
Varistor Voltage Change	within $\pm 10\%$																																								
7.7	Capacitance/ Varistor Temperature Characteristics	Meet Table 2.	Capacitance shall be measured at each step specified in Table 3 after reaching the thermal equilibrium. The capacitance change against the capacitance at step 4 shall be calculated. <u>Table 3</u>																																						
		Table 2																																							
		<table border="1" style="width: 100%; border-collapse: collapse;"> <tr> <td style="width: 30%;">Appearance</td> <td>No damaged.</td> </tr> <tr> <td>Capacitance Change</td> <td>within $\pm 15\%$ ($\sim 125^\circ C$) within $+15\%/-40\%$ ($125^\circ C \sim$)</td> </tr> <tr> <td>Varistor Voltage Change</td> <td>within $\pm 10\%$</td> </tr> </table>		Appearance	No damaged.	Capacitance Change	within $\pm 15\%$ ($\sim 125^\circ C$) within $+15\%/-40\%$ ($125^\circ C \sim$)	Varistor Voltage Change	within $\pm 10\%$	<ul style="list-style-type: none"> • VFC2HR7 <table border="1" style="width: 100%; border-collapse: collapse;"> <thead> <tr> <th>Step</th> <th>1</th> <th>2</th> <th>3</th> <th>4</th> <th>5</th> <th>6</th> <th>7</th> </tr> </thead> <tbody> <tr> <td>Temp. ($^\circ C$)</td> <td>+20 ± 2</td> <td>-55 ± 2</td> <td>-40 ± 2</td> <td>+20 ± 2</td> <td>+85 ± 2</td> <td>+125 ± 2</td> <td>+20 ± 2</td> </tr> </tbody> </table> <ul style="list-style-type: none"> • VFC2HL8 <table border="1" style="width: 100%; border-collapse: collapse;"> <thead> <tr> <th>Step</th> <th>1</th> <th>2</th> <th>3</th> <th>4</th> <th>5</th> <th>6</th> <th>7</th> <th>8</th> </tr> </thead> <tbody> <tr> <td>Temp. ($^\circ C$)</td> <td>+20 ± 2</td> <td>-55 ± 2</td> <td>-40 ± 2</td> <td>+20 ± 2</td> <td>+85 ± 2</td> <td>+125 ± 2</td> <td>+150 ± 2</td> <td>+20 ± 2</td> </tr> </tbody> </table>	Step	1	2	3	4	5	6	7	Temp. ($^\circ C$)	+20 ± 2	-55 ± 2	-40 ± 2	+20 ± 2	+85 ± 2	+125 ± 2	+20 ± 2	Step	1	2	3	4	5	6	7	8	Temp. ($^\circ C$)	+20 ± 2	-55 ± 2	-40 ± 2	+20 ± 2	+85 ± 2
Appearance	No damaged.																																								
Capacitance Change	within $\pm 15\%$ ($\sim 125^\circ C$) within $+15\%/-40\%$ ($125^\circ C \sim$)																																								
Varistor Voltage Change	within $\pm 10\%$																																								
Step	1	2	3	4	5	6	7																																		
Temp. ($^\circ C$)	+20 ± 2	-55 ± 2	-40 ± 2	+20 ± 2	+85 ± 2	+125 ± 2	+20 ± 2																																		
Step	1	2	3	4	5	6	7	8																																	
Temp. ($^\circ C$)	+20 ± 2	-55 ± 2	-40 ± 2	+20 ± 2	+85 ± 2	+125 ± 2	+150 ± 2	+20 ± 2																																	

8. Q200 Requirement**8-1. Performance (based on Table 13 for Ferrite EMI SUPPRESSORS/FILTERS)
AEC-Q200 Rev.D issued June. 1 2010**

AEC-Q200			Murata Specification / Deviation						
No.	Stress	Test Method							
3	High Temperature Exposure (Storage)	1000hours at 125C Set for 24hours at room temperature, then measured. Measurement at 24+/-2 hours after test conclusion.	Meet Table 4 after testing. Table 4 <table border="1"> <tr> <td>Appearance</td> <td>No damaged.</td> </tr> <tr> <td>Capacitance Change</td> <td>within ± 10%</td> </tr> <tr> <td>Varistor Voltage Change</td> <td>within ± 10%</td> </tr> </table>	Appearance	No damaged.	Capacitance Change	within ± 10%	Varistor Voltage Change	within ± 10%
Appearance	No damaged.								
Capacitance Change	within ± 10%								
Varistor Voltage Change	within ± 10%								
4	Temperature Cycling	1000cycles(-55C to 125C) Measurement at 24±2 hours after test conclusion.	Meet Table 4 after testing.						
5	Destructive Physical Analysis	Per EIA469 No electrical tests	Not Applicable						
7	Biased Humidity	1000hours 85C/85%RH. Apply Maximum rated Voltage. Measurement at 24+/-2 hours after test conclusion.	Meet Table 4 after testing.						
8	Operational Life	1000hours at 125C Apply Maximum rated Voltage. Measurement at 24+/-2 hours after test conclusion.	Meet Table 4 after testing.						
9	External Visual	Visual inspection	No abnormalities						
10	Physical Dimension	Meet ITEM 10.1 (Style and Dimensions)	No defects						
11	Terminal Strength (Leaded)	Per MIL-STD-202 Method 211 Conditions:A,C	Condition E: Not Applicable Lead wire should not cut off. Capacitor should not be broken.						
12	Resistance to Solvents	Per MIL-STD-202 Method 215	Not Applicable						
13	Mechanical Shock	Per MIL-STD-202 Method 213 Figure 1 of Method 213. Condition C(100g's/6ms/Half sine) Three times each 6 direction.	Meet Table 4 after testing.						
14	Vibration	5g's for 20 minutes, 12cycles each of 3 orientations Oscillation Frequency : 10-2000Hz.	Meet Table 4 after testing.						
15	Resistance to Soldering Heat	No heating. 260C +/-5 degree C Immersion time 10s	Meet Table 4 after testing.						
17	ESD	Per AEC-Q200-002	Meet Table 4 after testing. ESD Rank: Refer to Item 3. Rating.						
18	Solderbilty	Per J-STD-002 Method A	Along the circumference of terminal shall be covered with new solder at least 90%.						
19	Electrical Characterization	Measured :Capacitance	No defects						
20	Flammability	Per UL-94	Not Applicable						
21	Board Flex	Per AEC Q200-005	Not Applicable						
30	Electrical Transient Conduction	Per ISO-7637-2	Not Applicable						

9. Mounting Hole

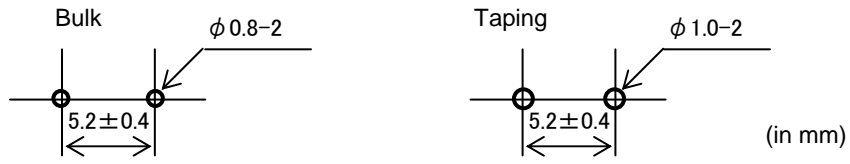

10. Style and Dimension

10.1 Bulk Type

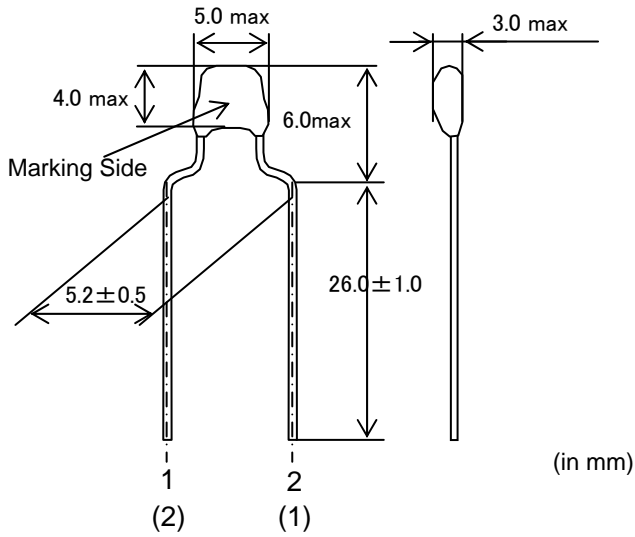

10.2 Taping Type

(All symbols in the illustrations below are described in Table 5.)

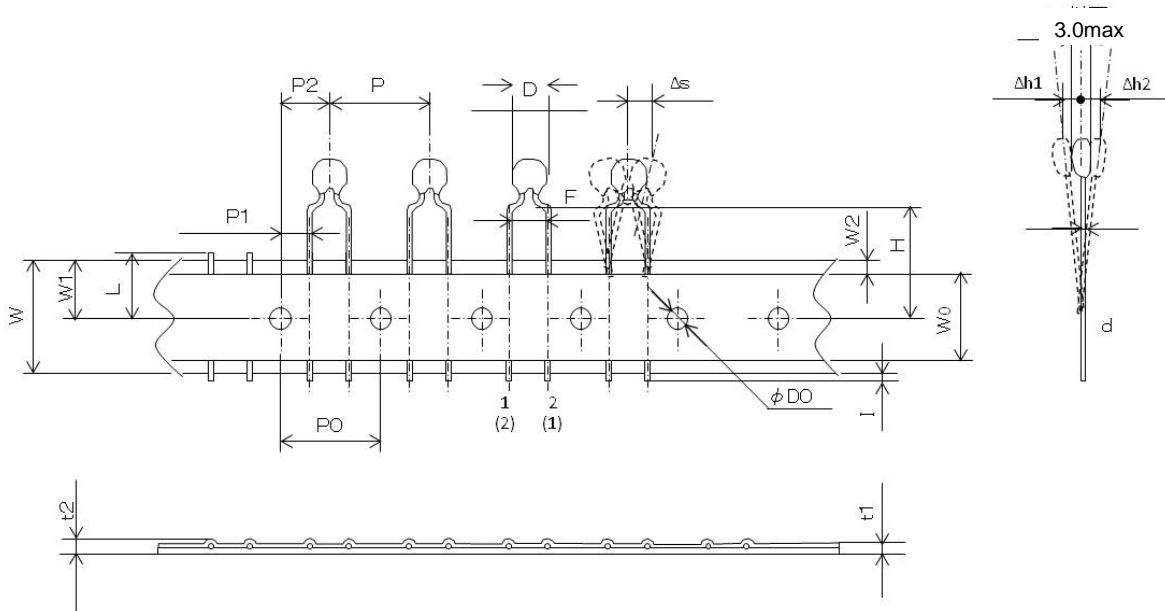

Table 5

Code	Description	Dimensions	Remark
P	Pitch of Component	12.7	Product Inclination ΔS Determines Crossing
P ₀	Pitch of Sprocket Hole	12.7±0.2	
P ₁	Length from Hole Center to Lead	3.85±0.7	
P ₂	Length from Hole Center to Component Center	6.35±1.3	Shift In Tape In Direction of Feed
D	Width of Body	5.0 max.	
ΔS	Deviation along tape, Left or Right	0±1.0	
W	Carrier Tape Width	18.0±0.5	
W ₁	Position of Sprocket Hole	9.0± ⁰ _{0.5}	Tape Widthwise Shift
l	Protrusion Length	+0.5 ~ -1.0	
D ₀	Diameter of Sprocket Hole	φ 4.0±0.1	
d	Lead Diameter	φ 0.48	
t ₁	Total Tape Thickness	0.6±0.3	Includes Thickness of Bonding Tape
t ₂	Total Thickness, Tape and Lead Wire	1.5 max.	
Δh ₁	Deviation across Tape,front	1.0 max.	
Δh ₂	Deviation across Tape,rear	1.0 max.	
L	Portion to Cut in Case of Defect	11.0± ⁰ _{1.0}	
W ₀	Hold Down Tape Width	12.0±0.5	
W ₂	Hold Down Tape Position	1.5±1.5	
H	Lead length between sprocket hole and forming position	18.5±1.0	
F	Lead Spacing	5.0± ^{0.8} _{0.2}	

(in mm)

11.Taping

11.1 (1) A maximum of 0.3% of the components quantity per reel or Ammo pack may be missing without consecutive missing components.

(2) The adhesive power of the tape shall have over 2.94N at the following condition.
F 2.94 N

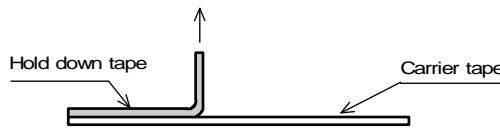

(3) Splicing method of tape

1. Carrier tape

Carrier tape shall be spliced by cellophane tape.
Overall thickness shall be less than 1.05 mm.

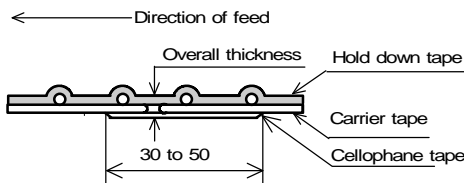

(in mm)

2. Hold down tape

Hold down tape shall be spliced with overlapping.
Overall thickness shall be less than 1.05 mm.

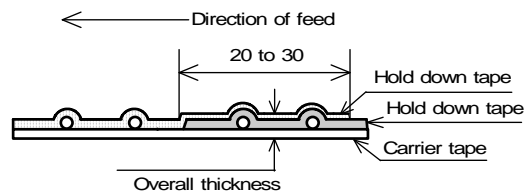

(in mm)

3. Both carrier tape and hold down tape

Both tapes shall be cut zigzag and spliced with splicing tape.

12. Packing

12.1 Packing quantity

Minimun Packing Form and Quantity

Terminal Configuration	A Unit Quantity	Packing Form
Bulk	250 pcs.	In a plastic bag
Taping	2000 pcs.	In an Ammo pack

* A quantity in a container is depending on a quantity of an order.

12.2 Packing Form

(1)Bulk

<A plastic bag pack>

1.Products are packed into a plastic bag.

2.The plastic bags are put into a container (corrugated cardboard box) depending on a quantity of an order.

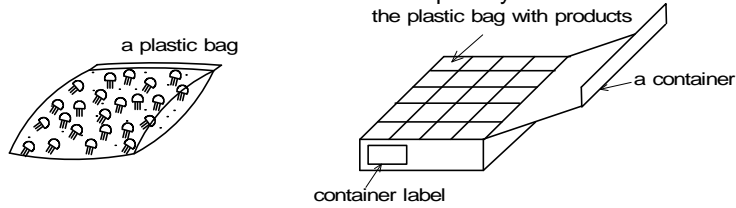

(2) Taping

• An ammo pack

1. Folding the tape per 25 pitches, products are packed into an ammo package so that each product of each layer wound zigzag is put on top of one another.
2. The dimensions of the ammo package are as follows.
3. The ammo packages are put into a container (corrugated cardboard box) depending on a quantity of an order.
4. Not less than 3 consecutive of component shall be missing on both edge of tape.

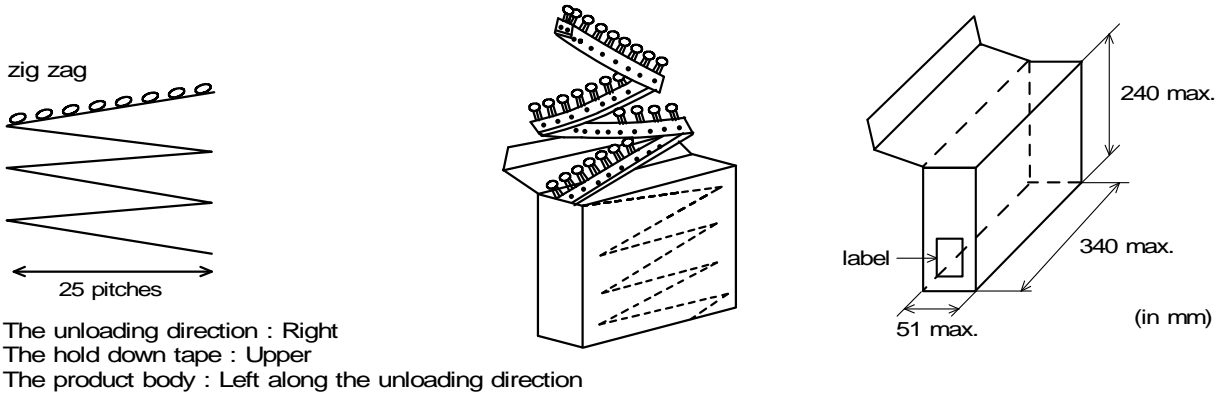

13. Marking on package

13.1 Unit Package

Bulk : Marked on a plastic bag.
Taping : Marked on a label stuck on a reel.

Marking on a unit package consists of :

Customer part number, MURATA part number, Inspection number(*1), RoHS marking(*2), Quantity, etc

*1) « Expression of Inspection No. » □□ 0000 XXX

(1) Factory Code

(2) Date

First digit : Year / Last digit of year

Second digit : Month / Jan. to Sep. → 1 to 9, Oct. to Dec. → O,N,D

Third, Fourth digit : Day

(3) Serial No.

*2) « Expression of RoHS marking » ROHS – $\frac{Y}{(1) (2)}$ (Δ)

(1) RoHS regulation conformity parts.

(2) MURATA classification number

13.2 Container

Marking on the label stucked on a container consists of :

Customer name Purchasing Order Number, Customer Part Number, MURATA part number,

RoHS marking (*2), Quantity, etc

14. Caution

14.1 Mounting holes

Mounting holes should be designed as specified in this specifications.

Or different design from this specifications may cause cracks in ceramics which may lead to smoking / firing.

14.2 Lead Type Capacitors with Varistor Function

Products should not be applied for the absorption of surges which have large energy (ex. lighting surges, switching surges) because it is designed for the absorption of motor surges.

14.3 Caution for the product angle adjust work

Take care not to apply any mechanical stress to product body at the lead terminal bending process for product angle adjustment after insertion.

14.4 Limitation of Applications

Please contact us before using our products for the applications listed below which require especially high reliability for the prevention of defects which might directly cause damage to the third party's life, body or property.

- | | |
|--|--|
| (1) Aircraft equipment | (7) Traffic signal equipment |
| (2) Aerospace equipment | (8) Disaster prevention / crime prevention equipment |
| (3) Undersea equipment | (9) Data-processing equipment |
| (4) Power plant control equipment | (10) Applications of similar complexity and /or reliability requirements |
| (5) Medical equipment | to the applications listed in the above |
| (6) Transportation equipment (vehicles, trains, ships, etc.) | |

14.5 Operating Voltage

When DC-rated capacitors are to be used in AC or ripple current circuits, be sure to maintain the Vp-p value of the applied voltage or the V0-p which contains DC bias within the rated voltage range. When the voltage is applied to the circuit, starting or stopping may generate irregular voltage for a transit period because of resonance or switching. Be sure to use a capacitor with a rated voltage range that includes these irregular voltages.

When DC-rated capacitors are to be used in input circuits from commercial power source (AC filter), be sure to use Safety Recognized Capacitors because various regulations on withstand voltage or impulse withstand established for all equipment should be taken into consideration.

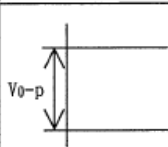
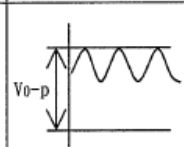
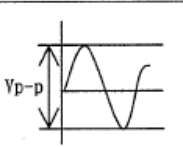
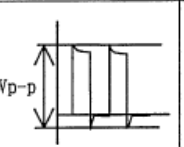
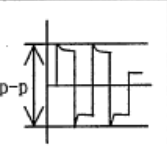
Type of Voltage	DC Voltage	DC + AC Voltage	AC Voltage	Pulse Voltage (1)	Pulse Voltage (2)
Measuring Position					

15. Notice

15.1 Soldering

- (1) Use rosin-based flux. Do not use strong acidic flux with halide content exceeding 0.2(wt)% (chlorine conversion value).
Use Sn-3.0Ag-0.5Cu solder
- (2) Standard flow soldering profile.

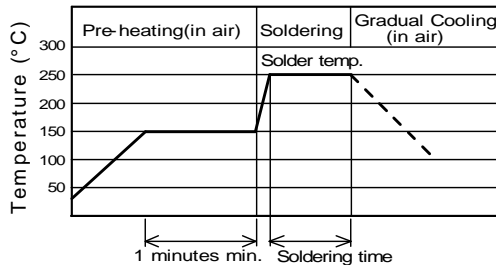

Solder temperature	Soldering time
250~260 °C	4~6s

- (3) Resistance to soldering iron goes in the following condition that tip temperature is 350 °C max. and soldering time is 5 s max.
- (4) Products and the leads should not be subject to any mechanical stress during soldering process. (and also while subject to the equivalent high temperature.)
- (5) When the outer coating is hot (over 100 degreescentigrade) after soldering, it becomes soft and fragile,so please be careful not to give it mechanical stress.

15.2 Cleaning Conditions

Do not clean after soldering.

15.3 Operating Temperature and Self-generated Heat

Keep the surface temperature of a capacitor with varistor function below the upper limit of its rated operating temperature range. Be sure to take into account the heat generated by the capacitor itself. When the capacitor is used in a highfrequency current, pulse current or similar current, it may have self-generated heat due to dielectric loss. In the case of " X7R char. Capacitors," applied voltage load should be such that self-generated heat is within 20 °C under the condition where the capacitor is subjected at an atmosphere temperature of 25 °C. When measuring, use a thermocouple of small thermal capacity -K of ø0.1mm under conditions where the capacitor is not affected by radiant heat from other components or wind from surroundings. Excessive heat may lead to deterioration of the capacitor's characteristics and reliability. Never attempt to perform measurement with the cooling fan running. Otherwise, accurate measurement cannot be ensured.

15.4 Operating Environment

- (1) Do not use products in corrosive gases such as chlorine gas, acid or sulfide gas.
- (2) Do not use products in the environment where water, oil or organic solvents may adhere to products.
- (3) Do not adhere any resin to products, coat nor mold products with any resin (including adhesive)to prevent mechanical and chemical stress on products.

15.5 Vibration and impact

Do not expose a capacitor with varistor function or its leads to excessive shock or vibration during use.

15.6 Capacitance change of capacitor

Temperature Charaistristics : X7R

In case Capacitors have an aging characteristic, whereby the capacitor continually decreases its capacitance slightly if the capacitor is left on for a long time. Moreover, capacitance might change greatly depending on the surrounding temperature or an applied voltage. Please contact us if you use a capacitor with varistor function in a circuit that needs a tight (narrow) capacitance tolerance (e.g., a time-constant circuit).

15.7 Storage and handling requirements

(1) Storage period

Use the products within 12 months after delivered.

Solderability should be checked if this period is exceeded.

(2) Storage environment condition

To prevent products quality deterioration, storage conditions should be controlled as follows ;

1. Temperature : -10 to 40 degrees centigrade

2. Humidity : 15 to 85% relative humidity

3. Products should be stored without sudden changes in temperature and humidity.

Don't keep products in corrosive gases such as sulfur, chlorine gas or acid,
or it may cause oxidization of lead terminals resulting in poor solderability.

4. Products should be stored on the palette for the prevention of the influence from humidity, dust and so on.

5. Products should be stored in the warehouse without heat shock, vibration, direct sunlight and so on.

(3) Handling Conditions

Care should be taken when transporting or handling product to avoid excessive vibration or mechanical shock.

16.  Note

(1) Please make sure that your product has been evaluated in view of your specifications with our product being mounted to your product.

(2) You are requested not to use our product deviating from the reference specifications.

(3) The contents of this reference specification are subject to change without advance notice. Please approve our product specifications or transact the approval sheet for product specifications before ordering.