

MMBTA06-HF (NPN)

RoHS Device
Halogen Free

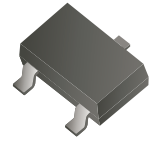

Features

- Epoxy meets UL-94 V-0 flammability rating.
- Moisture sensitivity Level 1.
- Surface mount package ideally suited for automatic insertion.

Mechanical data

- Case: SOT-23, molded plastic.
- Terminals: Tin plated leads, solderable per J-STD-002 and JESD22-B102.

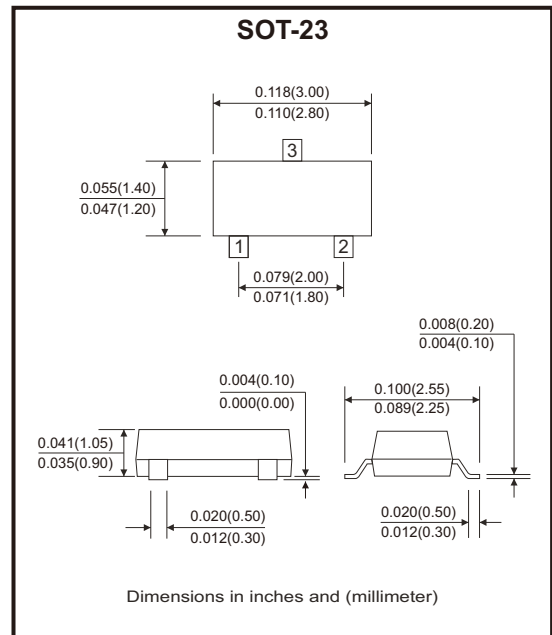

Circuit Diagram

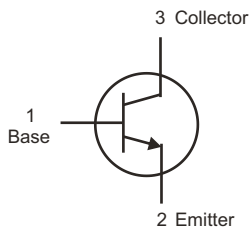

Maximum Ratings (at TA=25°C unless otherwise noted)

Parameter	Symbol	Value	Unit
Collector-base voltage	V _{CB0}	80	V
Collector-emitter voltage	V _{CEO}	80	V
Emitter-base voltage	V _{EBO}	4	V
Collector current	I _c	500	mA
Collector power dissipation	P _c	300	mW
Operation junction temperature range	T _J	-55 to +150	°C
Storage temperature range	T _{STG}	-55 to +150	°C
Thermal resistance from junction to ambient	R _{θJA}	417	°C/W

Electrical Characteristics (at $T_A=25^\circ\text{C}$ unless otherwise noted)

Parameter	Conditions	Symbol	Min	Max	Unit
Collector-base breakdown voltage	$I_C = 100\mu\text{A}$, $I_E = 0$	V_{CB0}	80		V
Collector-emitter breakdown voltage	$I_C = 1\text{mA}$, $I_B = 0$	V_{CEO}	80		V
Emitter-base breakdown voltage	$I_E = 100\mu\text{A}$, $I_C = 0$	V_{EBO}	4		V
Collector-base cut-off current	$V_{CB} = 60\text{V}$, $I_E = 0$	I_{CBO}		100	nA
Collector-emitter cut-off current	$V_{CE} = 60\text{V}$, $I_B = 0$	I_{CEO}		100	nA
Emitter-base cut-off current	$V_{EB} = 3\text{V}$, $I_C = 0$	I_{EBO}		100	nA
DC current gain	$V_{CE} = 1\text{V}$, $I_C = 10\text{mA}$	$h_{FE(1)}$	100	400	
	$V_{CE} = 1\text{V}$, $I_C = 100\text{mA}$	$h_{FE(2)}$	100		
Collector-emitter saturation voltage	$I_C = 100\text{mA}$, $I_B = 10\text{mA}$	$V_{CE(sat)}$		0.25	V
Base-emitter saturation voltage	$I_C = 100\text{mA}$, $I_B = 10\text{mA}$	$V_{BE(sat)}$		1.20	V
Transition frequency	$V_{CE} = 2\text{V}$, $I_C = 10\text{mA}$, $f = 100\text{MHz}$	f_T	100		MHz

Rating and Characteristic Curves (MMBTA06-HF)

Fig.1 - Static Characteristic

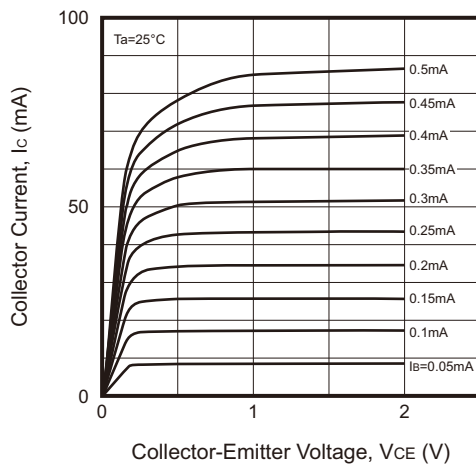

Fig.2 - DC Current Gain

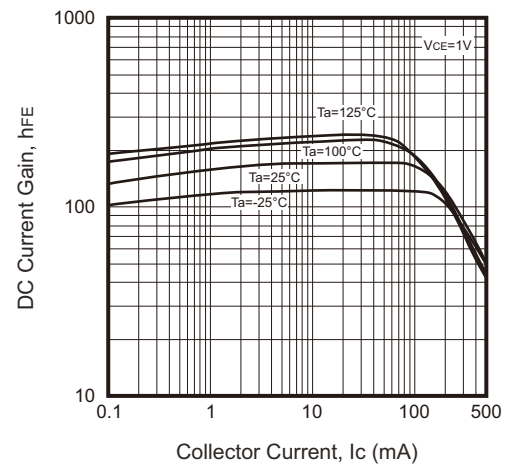

Fig.3 - Collector-Emitter Saturation Voltage

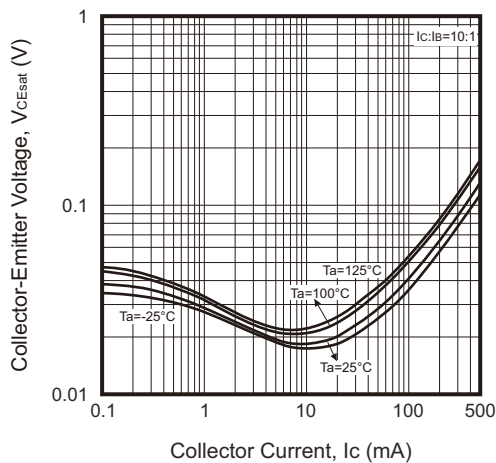
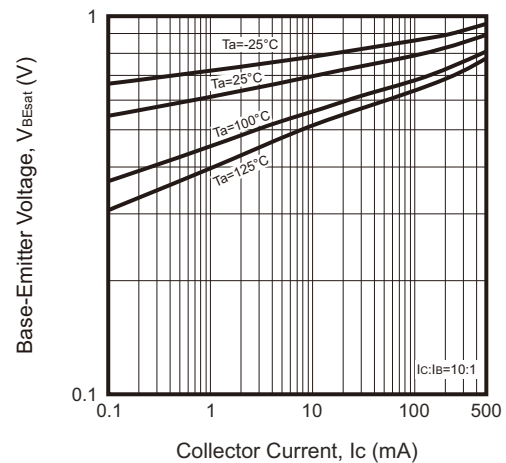

Fig.4 - Base-Emitter Saturation Voltage



Company reserves the right to improve product design, functions and reliability without notice.

REV:B

Rating and Characteristic Curves (MMBTA06-HF)

Fig.5 - Base-Emitter on Voltage

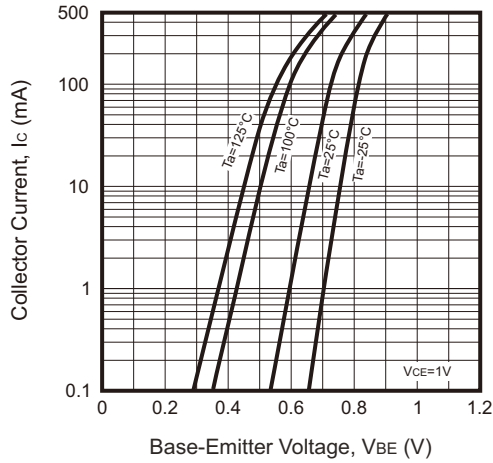

Fig.6 - $C_{ob}/C_{ib} - V_{CB}/V_{EB}$

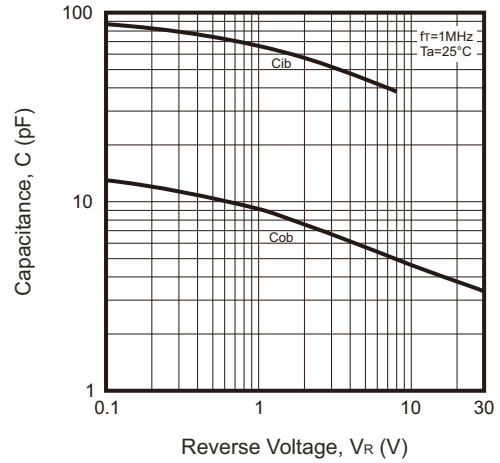
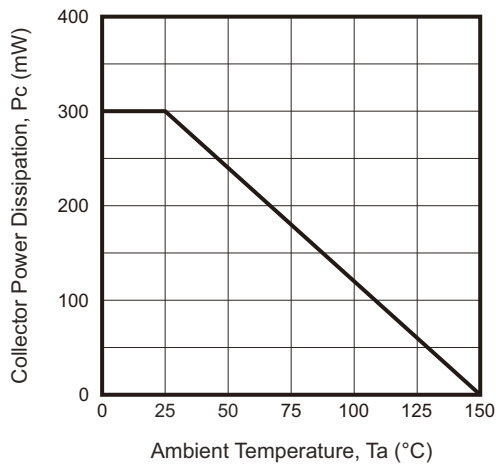
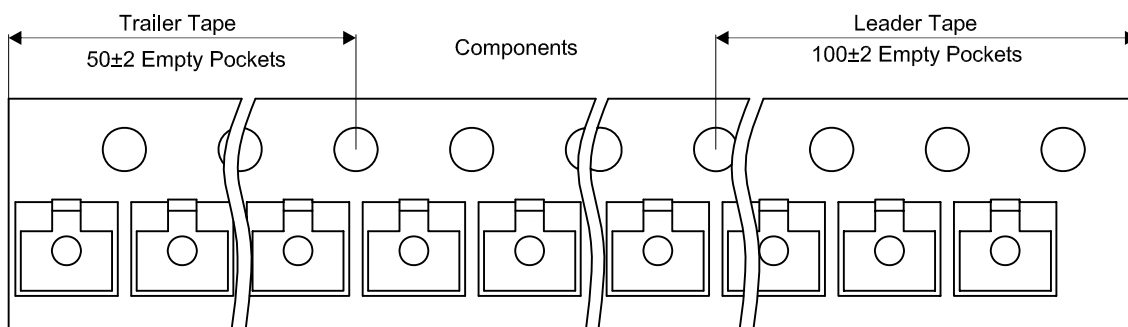
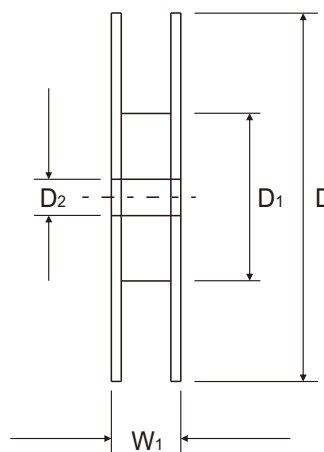
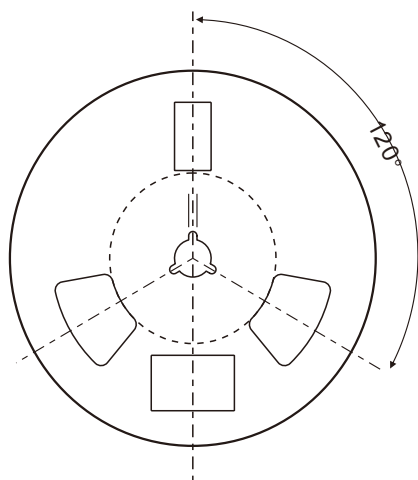
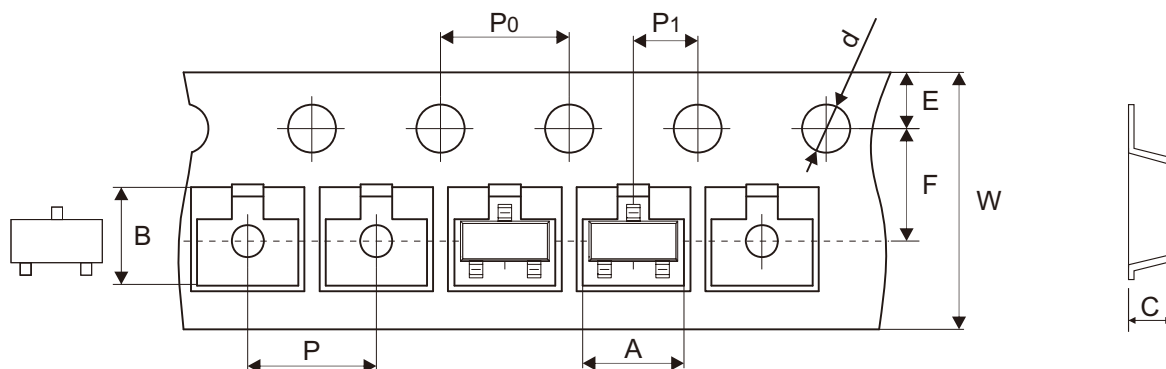

Fig.7 - Collector Power Derating Curve



Reel Taping Specification



SOT-23	SYMBOL	A	B	C	d	D	D ₁	D ₂
	(mm)	3.15 ± 0.10	2.77 ± 0.10	1.22 ± 0.10	1.50 + 0.10 - 0.00	178.00 ± 1.00	54.60 ± 1.00	13.30 ± 1.00
	(inch)	0.124 ± 0.004	0.109 ± 0.004	0.048 ± 0.004	0.059 + 0.004 - 0.000	7.008 ± 0.039	2.150 ± 0.039	0.524 ± 0.039

SOT-23	SYMBOL	E	F	P	P ₀	P ₁	W	W ₁
	(mm)	1.75 ± 0.10	3.50 ± 0.05	4.00 ± 0.10	4.00 ± 0.10	2.00 ± 0.05	8.00 + 0.30 - 0.10	11.10 ± 0.20
	(inch)	0.069 ± 0.004	0.138 ± 0.002	0.157 ± 0.004	0.157 ± 0.004	0.079 ± 0.002	0.315 + 0.012 - 0.004	0.437 ± 0.008

Marking Code

Part Number	Marking Code
MMBTA06-HF	1GM

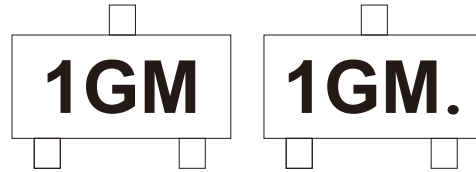

Solid dot = Control code

Suggested P.C.B. PAD Layout

SIZE	SOT-23	
	(mm)	(inch)
A	0.90	0.035
B	0.80	0.031
C	0.95	0.037
D	2.00	0.079
E	2.90	0.114

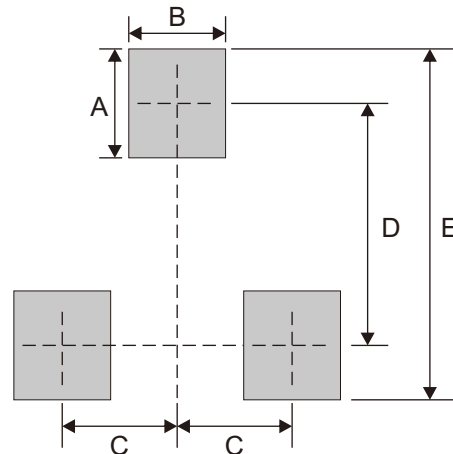

Note: 1. The pad layout is for reference purposes only.

Standard Packaging

Case Type	REEL PACK	
	REEL (pcs)	Reel Size (inch)
SOT-23	3,000	7