

# CMS40N03H8-HF

**N-Channel  
RoHS Device  
Halogen Free**

## Features

- Low on-resistance.
- Low miller charge.
- Low input capacitance.
- 100% EAS and Rg guaranteed.
- Green device available.

## Mechanical data

- Case: PR-PAK

## Circuit Diagram

- G : Gate
- S : Source
- D : Drain

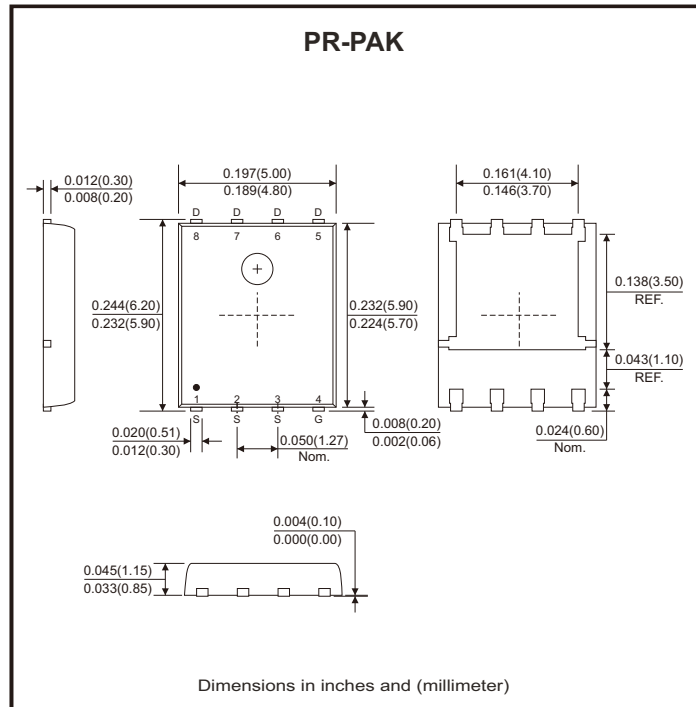
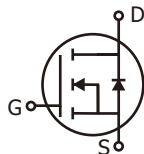

## Maximum Ratings

Parameter	Conditions	Symbol	Value	Unit
Drain-source voltage		$V_{DS}$	30	V
Gate-source voltage		$V_{GS}$	$\pm 20$	V
Continuous drain current	$T_C = 25^\circ C$	$I_D$	40	A
	$T_C = 70^\circ C$	$I_D$	40	
Pulsed drain current (Note 1)		$I_{DM}$	100	A
Continuous drain current	$T_A = 25^\circ C$	$I_D$	31	A
	$T_A = 70^\circ C$	$I_D$	25	
Total power dissipation	$T_C = 25^\circ C$	$P_D$	36	W
	$T_A = 25^\circ C$	$P_D$	4.2	
Single pulse avalanche energy, L=0.1mH		$E_{AS}$	72	mJ
Single pulse avalanche current, L=0.1mH		$I_{AS}$	38	A
Operating junction and storage temperature range		$T_J, T_{STG}$	-55 to +150	$^\circ C$
Thermal resistance junction-ambient (Note 2)	Steady state	$R_{\theta JA}$	30	$^\circ C/W$
Thermal resistance junction-case (Note 2)	Steady state	$R_{\theta JC}$	3.5	$^\circ C/W$

Notes: 1. The data tested by pulsed, pulse width  $\leq 300\mu s$ , duty cycle  $\leq 2\%$ .

2.  $R_{\theta JA}$  is the sum of the junction-to-case and case-to-ambient thermal resistance where the case thermal reference is defined as the solder mounting surface of the drain pins.  $R_{\theta JC}$  is guaranteed by design while  $R_{\theta CA}$  is determined by the user's board design.  $R_{\theta JA}$  shown below for single device operation on FR-4 in still air.

Company reserves the right to improve product design , functions and reliability without notice.

REV:A

## Electrical Characteristics (at $T_J=25^\circ\text{C}$ unless otherwise noted)

Parameter	Symbol	Conditions	Min	Typ	Max	Unit
Drain-source breakdown voltage	$BV_{DSS}$	$V_{GS} = 0V, I_D = 250\mu A$	30			V
Gate threshold voltage	$V_{GS(th)}$	$V_{DS} = V_{GS}, I_D = 250\mu A$	1.15		2.2	
Forward transconductance (Note 1)	$g_{fs}$	$V_{DS} = 15V, I_D = 19A$		82		S
Gate-source leakage current	$I_{GSS}$	$V_{GS} = \pm 20V$			$\pm 100$	nA
Drain-source leakage current	$I_{DSS}$	$V_{DS} = 30V, V_{GS} = 0V$			1	$\mu A$
Static drain-source on-resistance (Note 1)	$R_{DS(on)}$	$V_{GS} = 10V, I_D = 19A$		3.3	4.5	m $\Omega$
		$V_{GS} = 4.5V, I_D = 16A$		4.6	5.6	
Total gate charge (Note 1)	$Q_g$	$I_D = 19A, V_{DS} = 15V, V_{GS} = 4.5V$		12		nC
Gate-source charge	$Q_{gs}$			6		
Gate-drain ("miller") charge	$Q_{gd}$			5		
Turn-on delay time (Note 1)	$t_{d(on)}$	$V_{DS} = 15V, I_D = 10A$ $V_{GS} = 4.5V, R_G = 1\Omega, R_L = 1.5\Omega$		24		nS
Rise time	$t_r$			21		
Turn-off delay time	$t_{d(off)}$			25		
Fall time	$t_f$			17		
Input capacitance	$C_{iss}$	$V_{GS} = 0V, V_{DS} = 15V, f = 1MHz$		1750		pF
Output capacitance	$C_{oss}$			360		
Reverse transfer capacitance	$C_{rss}$			150		
Gate resistance	$R_g$	$f = 1MHz$		3.2	5.0	$\Omega$
<b>Source-drain diode</b>						
Diode forward voltage (Note 1)	$V_{SD}$	$I_S = 10A, V_{GS} = 0V$		0.8	1.2	V
Continuous source current (Note 1)	$I_S$				40	A
Reverse recovery time	$t_{rr}$	$I_F = 10A, T_J = 25^\circ\text{C}$ $dI/dt = 100A/\mu s$		25		nS
Reverse recovery charge	$Q_{rr}$				17	
<b>Guaranteed avalanche characteristics</b>						
Single pulse avalanche energy (Note 2)	EAS	$V_{DD} = 20V, L = 0.1mH, I_{AS} = 31A$	48			mJ

Notes: 1. The data tested by pulsed, pulse width  $\leq 300\mu s$ , duty cycle  $\leq 2\%$ .

2. The min. value is 100% EAS tested guarantee.

## Rating and Characteristic Curves (CMS40N03H8-HF)

Fig.1 - Typical Output Characteristics

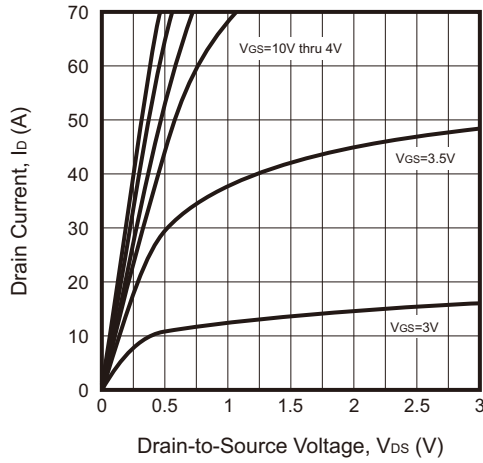

Fig.2 - On-Resistance vs. G-S Voltage

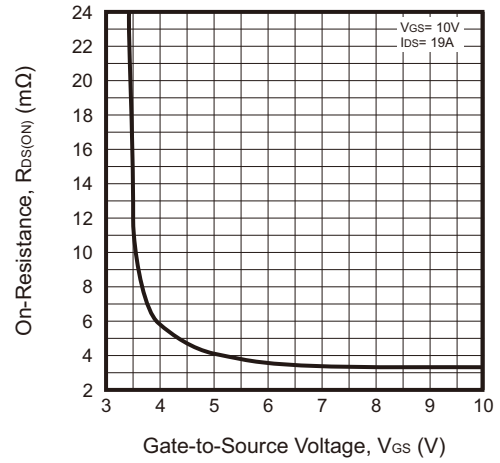

Fig.3 - On-Resistance vs. Drain Current

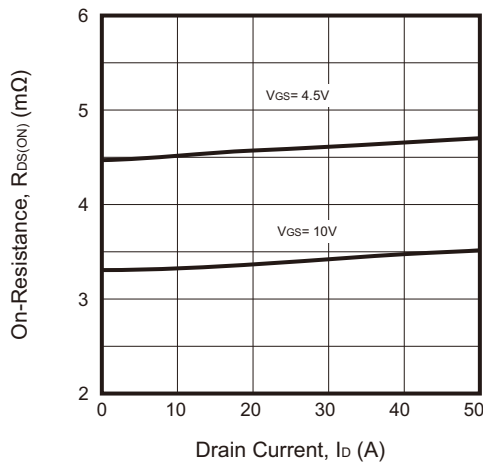

Fig.4 - Normalized  $R_{DS(ON)}$  vs.  $T_J$

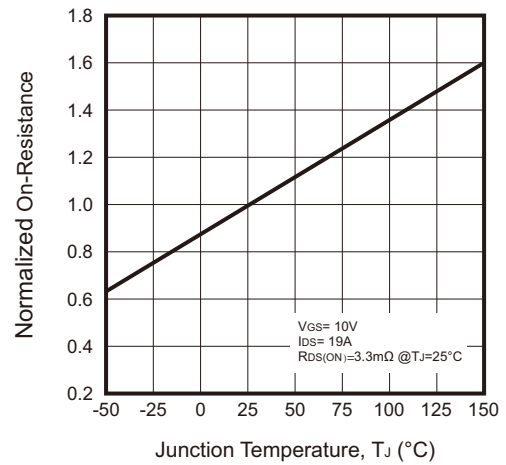

Fig.5 - Normalized  $V_{GS(th)}$  vs.  $T_J$

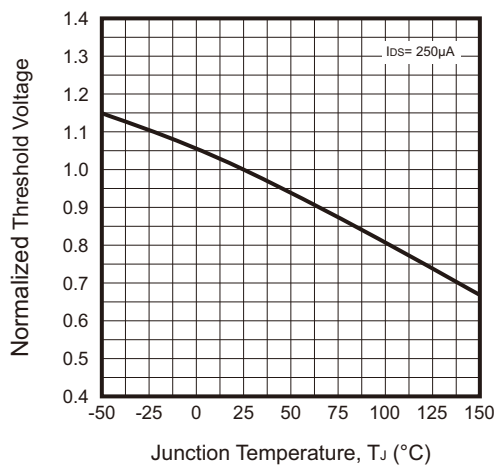
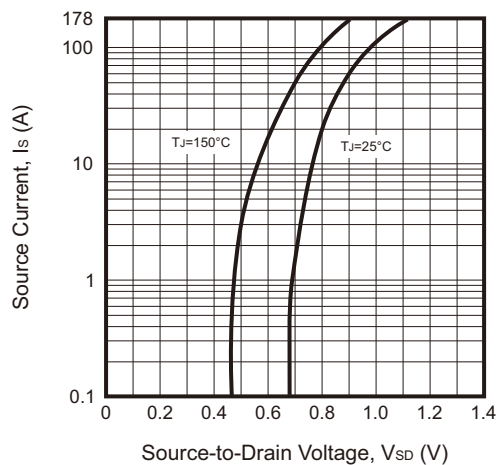

Fig.6 - Forward Characteristics of Reverse



Company reserves the right to improve product design, functions and reliability without notice.

REV:A

## Rating and Characteristic Curves (CMS40N03H8-HF)

Fig.7 - Gate Charge Characteristics

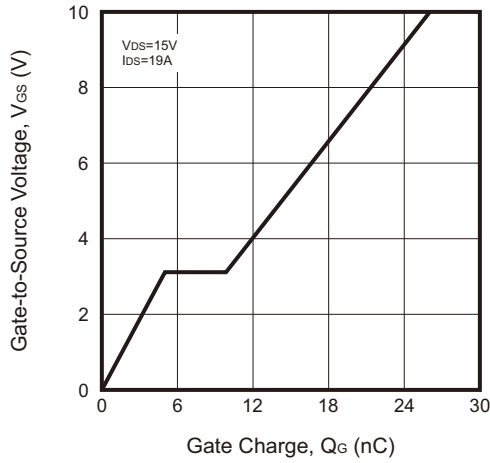

Fig.8 - Capacitance Characteristics

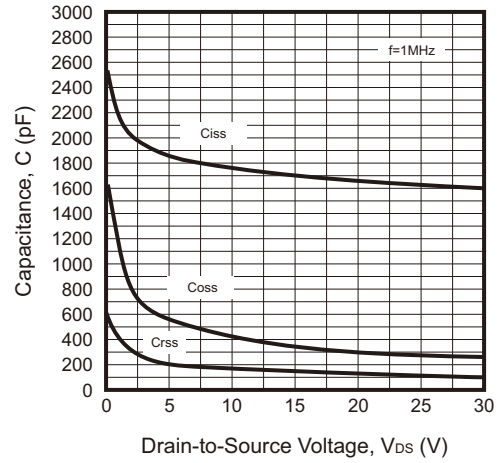

Fig.9 - Safe Operating Area

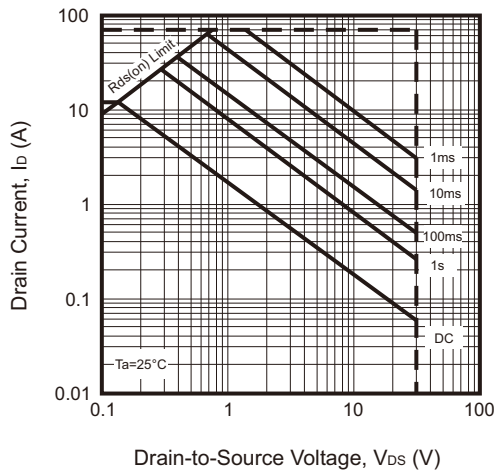

Fig.10 - Power Dissipation

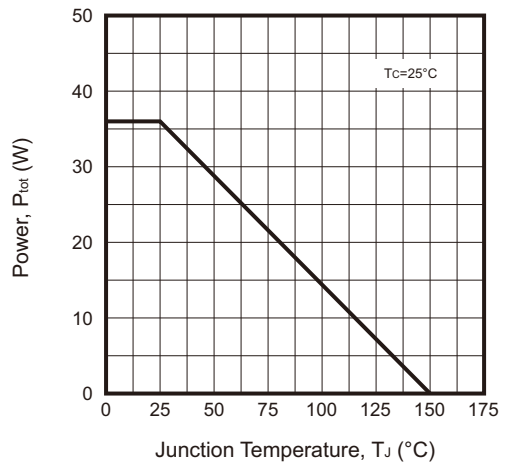
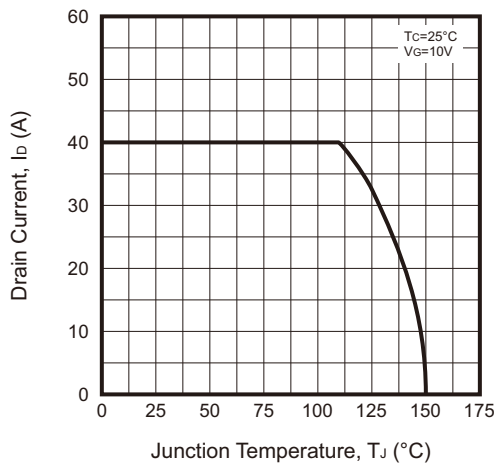
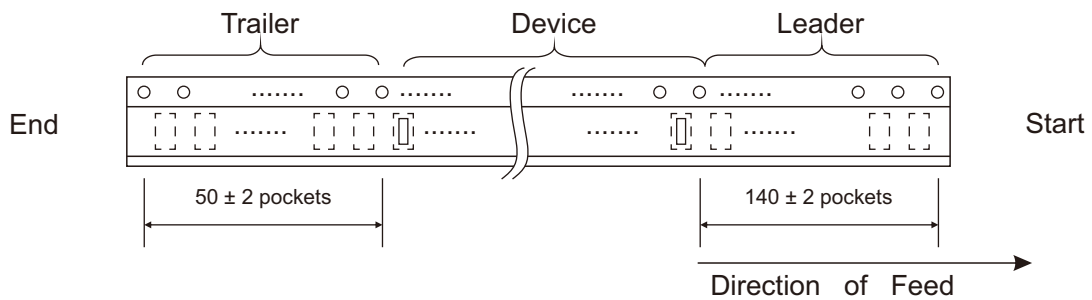
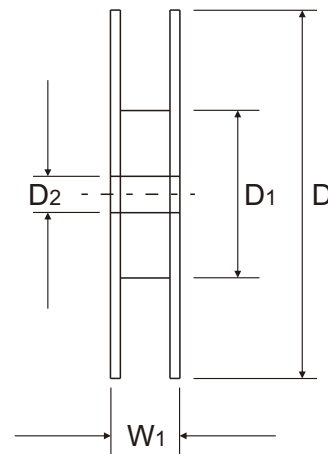
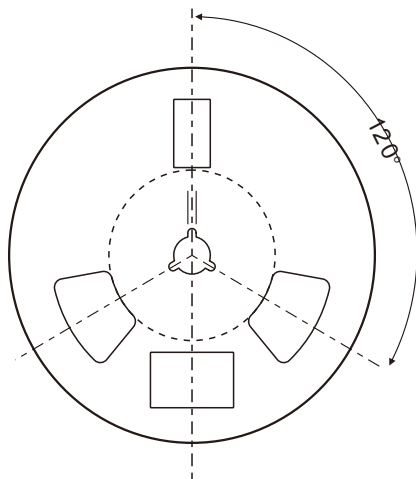
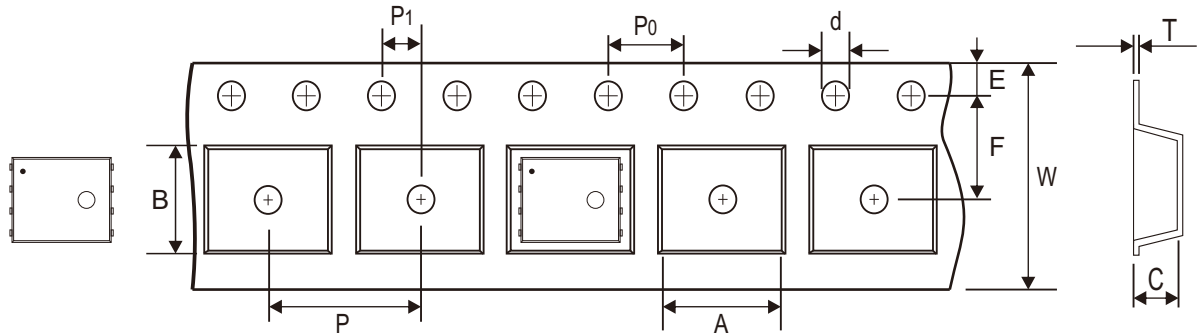

Fig.11 - Drain Current vs. T<sub>J</sub>



Reel Taping Specification



PR-PAK	SYMBOL	A	B	C	d	D	D1	D2
	(mm)	6.50 ± 0.10	5.30 ± 0.10	1.40 ± 0.10	1.50 + 0.10 - 0.00	330.00 ± 1.00	178.00 + 0.00 - 2.00	13.00 min.
	(inch)	0.256 ± 0.004	0.209 ± 0.004	0.055 ± 0.004	0.059 + 0.004 - 0.000	12.992 ± 0.039	7.008 + 0.000 - 0.079	0.512 min.

PR-PAK	SYMBOL	E	F	P	P0	P1	T	W	W1
	(mm)	1.75 ± 0.10	5.50 ± 0.05	8.00 ± 0.10	4.00 ± 0.10	2.00 ± 0.05	0.30 ± 0.05	12.00 ± 0.30	18.40 ref.
	(inch)	0.069 ± 0.004	0.217 ± 0.002	0.315 ± 0.004	0.157 ± 0.004	0.079 ± 0.002	0.012 ± 0.002	0.472 ± 0.012	0.724 ref.

Company reserves the right to improve product design , functions and reliability without notice. REV:A

## Marking Code

Part Number	Marking Code
CMS40N03H8-HF	30N06 XXXX

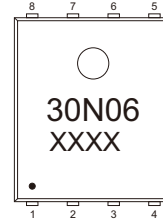

XXXX = Control code

## Suggested PAD Layout

SIZE	PR-PAK	
	(mm)	(inch)
A	1.27	0.050
B	0.61	0.024
C	4.42	0.174
D	1.27	0.050
E	6.61	0.260
F	4.32	0.170
G	4.52	0.178
H	3.81	0.150
I	3.91	0.154

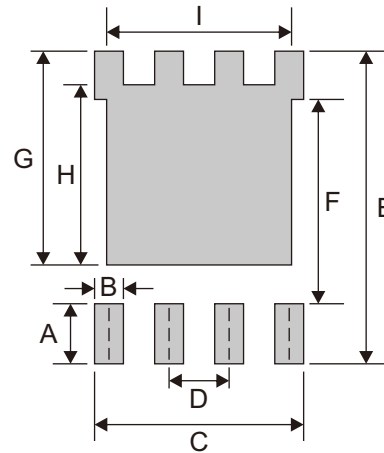

Note: 1. The pad layout is for reference purposes only.

## Standard Packaging

Case Type	REEL PACK	
	REEL ( pcs )	Reel Size (inch)
PR-PAK	3,000	13