

CDBHM240L-HF Thru. CDBHM2100L-HF

Reverse Voltage: 40 to 100 V

Forward Current: 2.0 A

RoHS Device

Halogen free

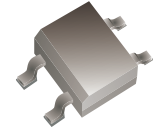

Features

- For surface mounted applications.
- Metal-Semiconductor junction with guarding.
- Epitaxial construction.
- Very low forward voltage drop.
- High current capability.
- Plastic material has UL flammability classification 94V-0.
- For use in low voltage, high frequency inverters, free wheeling, and polarity protection applications.

Mechanical data

- Case: molded plastic.
- Polarity: Indicated by cathode band.
- Weight: 0.125 grams (approx.).

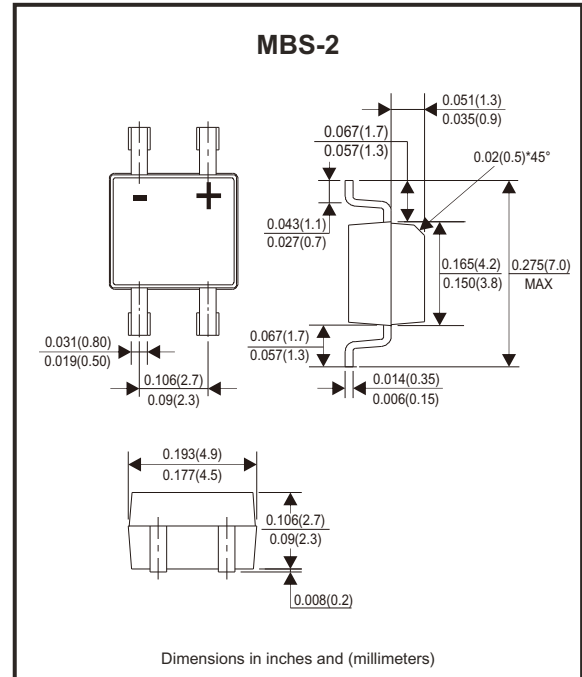

Circuit Diagram

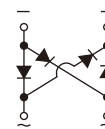

Maximum Ratings and Electrical Characteristics

Rating at $T_A=25^{\circ}\text{C}$, unless otherwise noted.
Single phase, half wave, 60Hz, resistive or inductive load.
For capacitive load, derate current by 20%.

Parameter	Symbol	CDBHM240L-HF	CDBHM260L-HF	CDBHM2100L-HF	Unit
Maximum recurrent peak reverse voltage	V_{RRM}	40	60	100	V
Maximum RMS voltage	V_{RMS}	28	42	70	V
Maximum DC blocking voltage	V_{DC}	40	60	100	V
Maximum average forward rectified current @ $T_L=100^{\circ}\text{C}$	$I_{(AV)}$	2.0			A
Peak forward surge current, 8.3mS single half sine-wave, superimposed on rated load (JEDEC method)	I_{FSM}	50			A
Maximum forward voltage at 2.0A DC	V_F	0.55	0.70	0.85	V
Maximum DC reverse current at rated DC blocking voltage @ $T_J=25^{\circ}\text{C}$ @ $T_J=100^{\circ}\text{C}$	I_R	1.0 20			mA
Typical junction capacitance (Note 1)	C_J	125			pF
Typical thermal resistance (Note 2)	$R_{\theta JA}$	20			$^{\circ}\text{C}/\text{W}$
Operating temperature range	T_J	-55 to +125			$^{\circ}\text{C}$
Storage temperature range	T_{STG}	-55 to +150			$^{\circ}\text{C}$

Notes: 1. Measured at 1.0MHz and applied reverse voltage of 4.0V DC.
2. Thermal resistance junction to lead.

Rating and Characteristic Curves (CDBHM240L-HF Thru. CDBHM2100L-HF)

Fig.1 - Forward Current Derating Curve

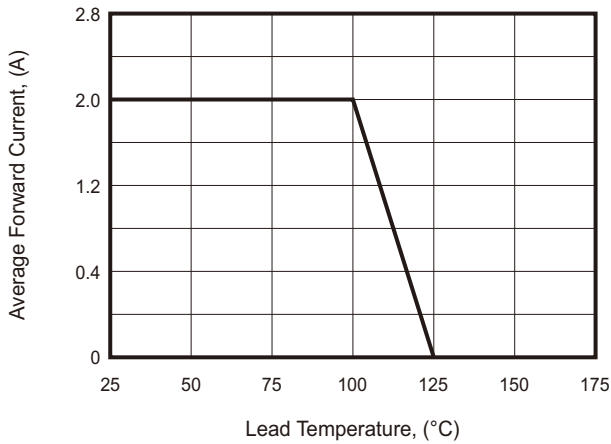

Fig. 2 - Maximum Non-Repetitive Surge Current

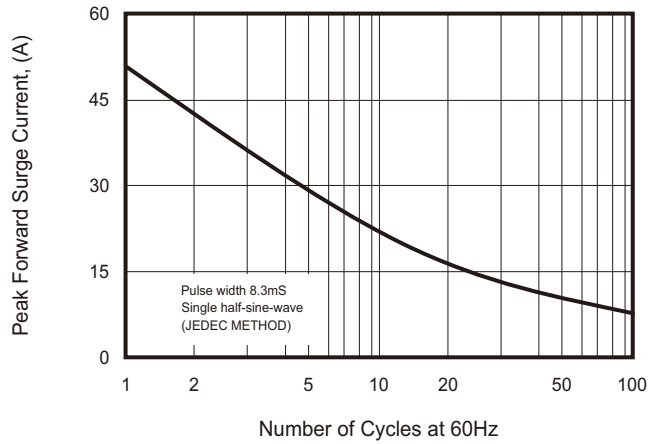

Fig.3 - Typical Forward Characteristics

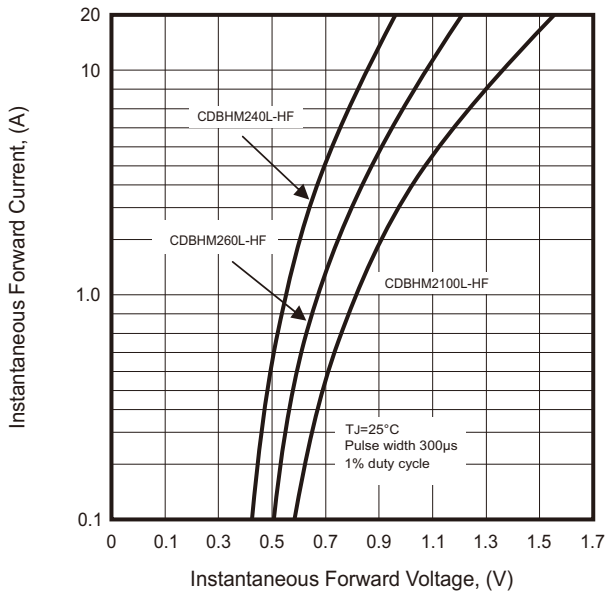

Fig.4 - Typical Junction Capacitance

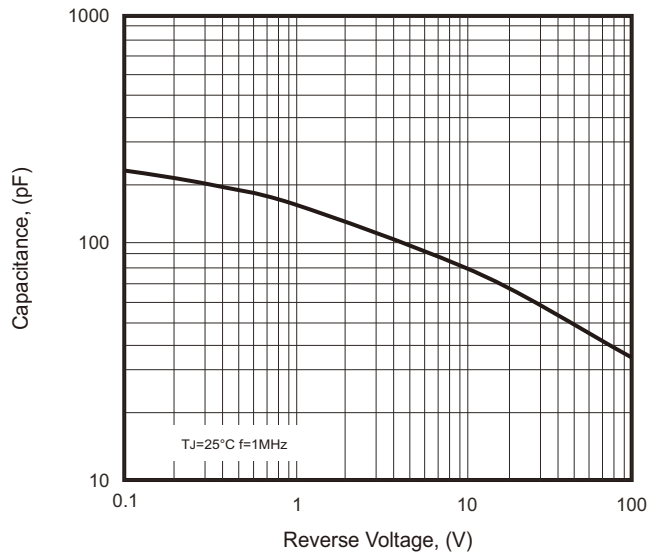
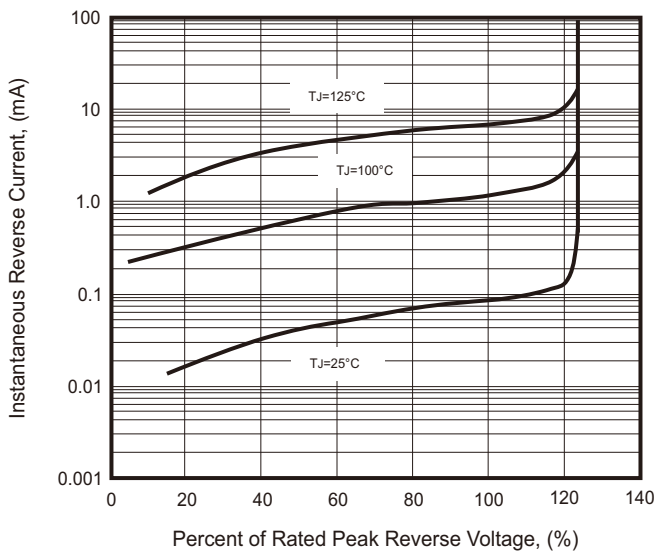
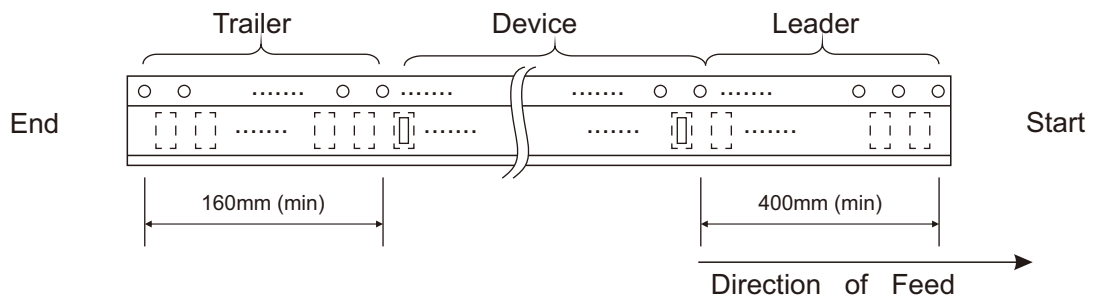
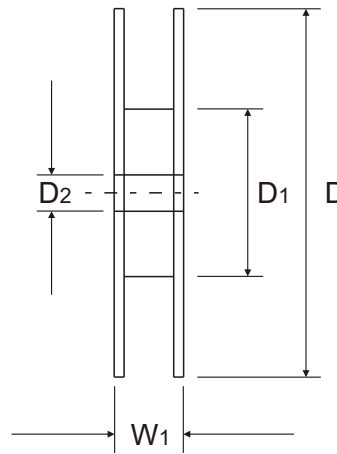
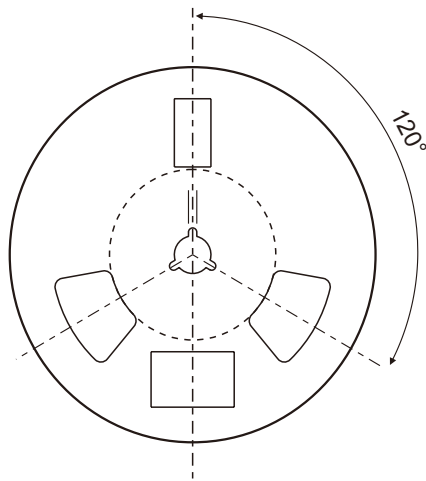
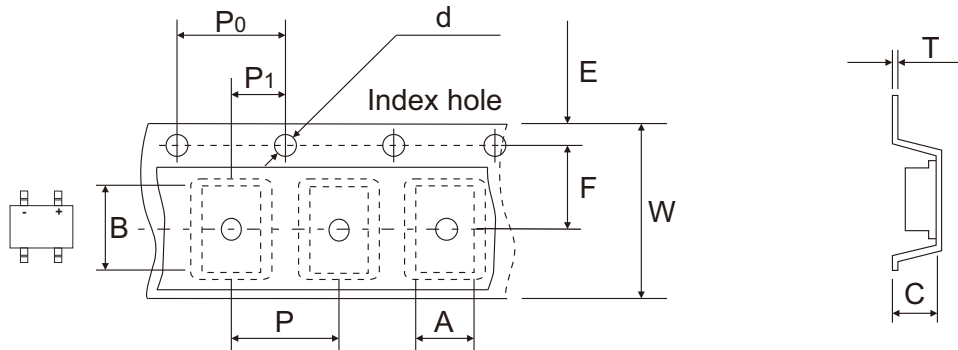

Fig.5 - Typical Reverse Characteristics



Reel Taping Specification



MBS-2	SYMBOL	A	B	C	d	D	D1	D2
	(mm)	4.90 ± 0.01	7.24 ± 0.10	3.33 ± 0.10	1.55 ± 0.10	330.0	50.0 MIN.	13.0 ± 0.20
	(inch)	0.93 ± 0.004	0.285 ± 0.004	0.131 ± 0.004	0.0610 ± 0.004	13.00	1.969 MIN.	0.512 ± 0.008

MBS-2	SYMBOL	E	F	P	P0	P1	W	W1
	(mm)	1.75 ± 0.10	5.50 ± 0.05	8.00 ± 0.10	4.00 ± 0.10	2.00 ± 0.05	12.00 ± 0.30	12.0~14.40
	(inch)	0.069 ± 0.004	0.217 ± 0.002	0.315 ± 0.004	0.157 ± 0.004	0.079 ± 0.002	0.472 ± 0.012	0.472~0.657

Marking Code

Part Number	Marking Code	
	SB24S	KMB24S
CDBHM240L-HF	SB24S	KMB24S
CDBHM260L-HF	SB26S	KMB26S
CDBHM2100L-HF	SB210S	KMB210S

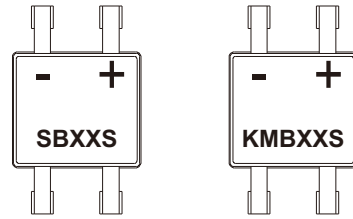

xx/xxx = Product type marking code

Suggested P.C.B. PAD Layout

SIZE	MBS-2	
	(mm)	(inch)
A	2.55 REF	0.100 REF
B	0.82 MIN	0.032 MIN
C	0.92 MIN	0.036 MIN
D	7.00 MAX	0.276 MAX

Note: 1. The pad layout is for reference purposes only.

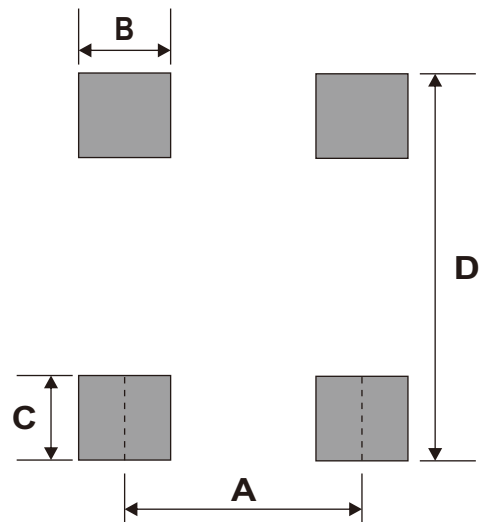

Standard Packaging

Case Type	REEL PACK	
	REEL (pcs)	Reel Size (inch)
MBS-2	3,000	13