

## CDBHA15150-HF

Reverse Voltage: 150V

Forward Current: 15A

RoHS Device

Halogen Free

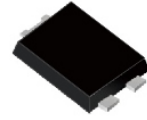

### Features

- Metal silicon junction, majority carrier conduction.
- High surge capability.
- High temperature soldering guaranteed: 260°C/10 seconds.
- High current capability, low forward voltage drop.

### Mechanical data

- Case: TO-277B, molded plastic.
- Epoxy: UL flammability classification rating 94V-0.
- Terminals: Solder plated, solderable per MIL-STD-202, method 208.

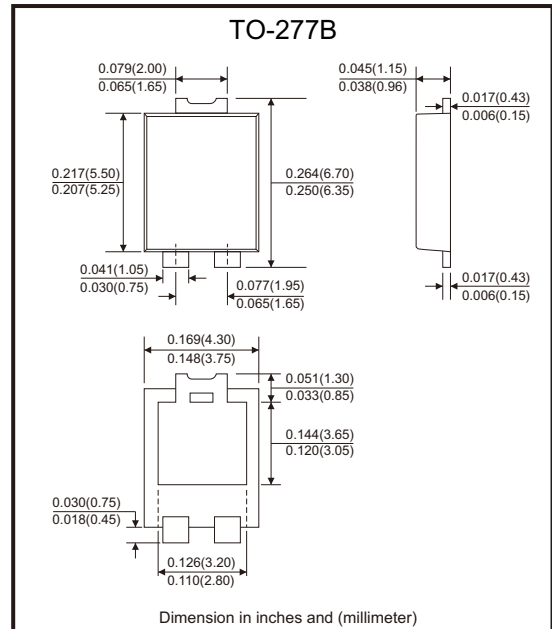

### Circuit Diagram

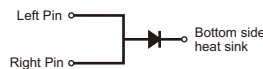

### Maximum Ratings (at TA=25°C, unless otherwise noted)

Parameter	Symbol	Value	Unit
Peak repetitive reverse voltage	$V_{RRM}$	150	V
RMS reverse voltage	$V_{RMS}$	105	V
DC blocking voltage	$V_{DC}$	150	V
Maximum average forward output current	$I_{F(AV)}$	15	A
Peak forward surge current, 8.3ms single half sine-wave	$I_{FSM}$	250	A
Typical thermal resistance (Note 1)	$R_{\theta JA}$	60	°C/W
	$R_{\theta JC}$	20	
	$R_{\theta JL}$	15	
Operating junction temperature range	$T_J$	-55 ~ +150	°C
Storage temperature range	$T_{STG}$	-55 ~ +150	°C

Notes: 1. Device mounted on PCB with 10mm x 20mm x 0.1mm copper pad areas.

### Electrical Characteristics (at TA=25°C, unless otherwise noted)

Parameter	Conditions	Symbol	Min.	Typ.	Max.	Unit
Max. instantaneous forward voltage (Note 1)	$I_F = 15A$ , @ $T_A = 25^\circ C$	$V_F$			0.85	V
Maximum reverse current (Note 2)	Rated $V_R$ , @ $T_J = 25^\circ C$ @ $T_J = 100^\circ C$	$I_R$			250	$\mu A$
					10	mA

Notes: 1. Pulse test: 300 $\mu s$  pulse width, 1% duty cycle.  
2. Pulse test: pulse width 40ms.

Company reserves the right to improve product design, functions and reliability without notice.

REV:A

## Rating and Characteristics Curves (CDBHA15150-HF)

Fig.1 - Forward Current Derating Curve

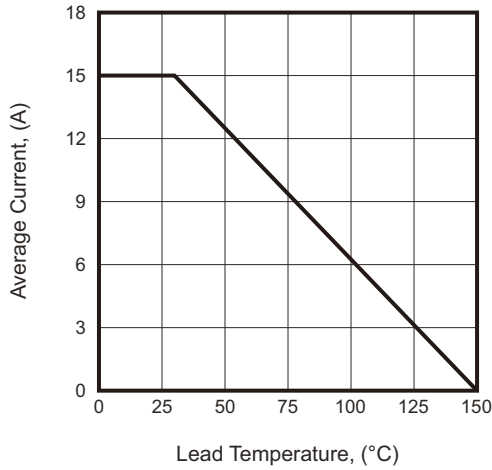

Fig.2 - Surge Current Derating Curve

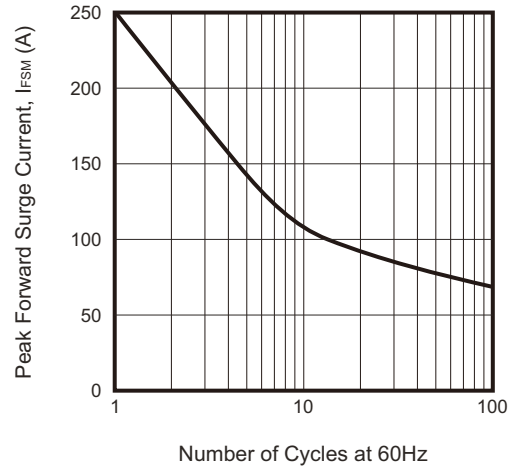

Fig.3 - Typical Forward Voltage Characteristics

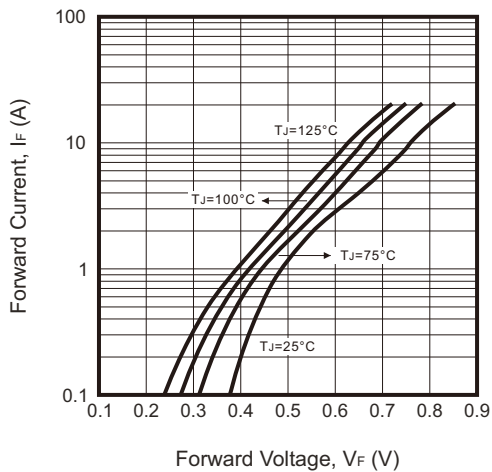
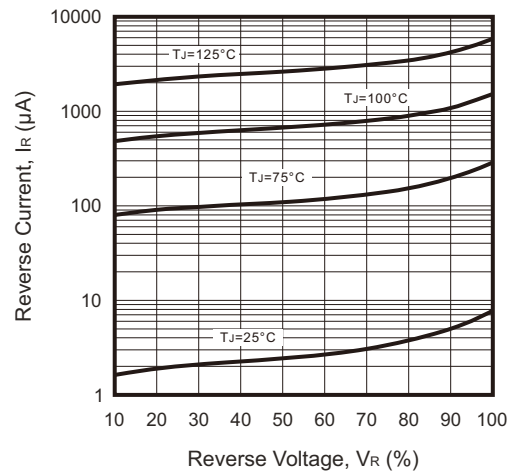
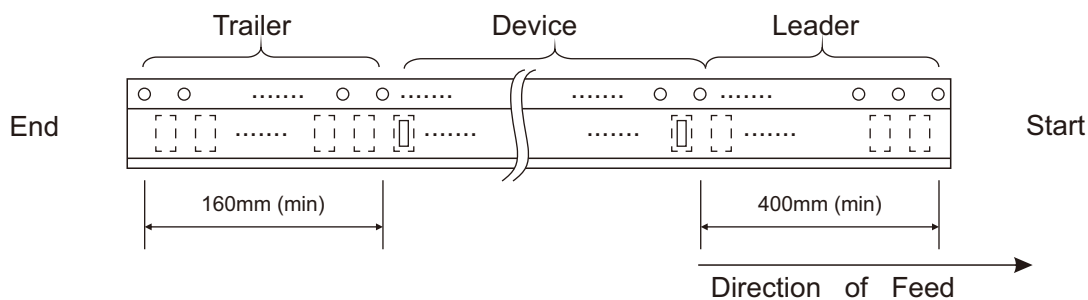
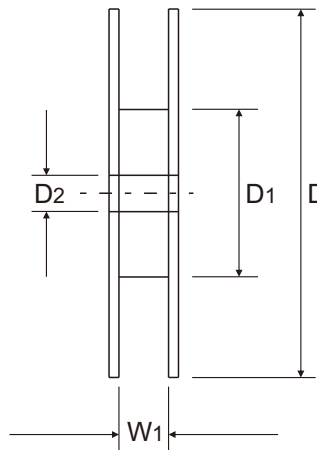
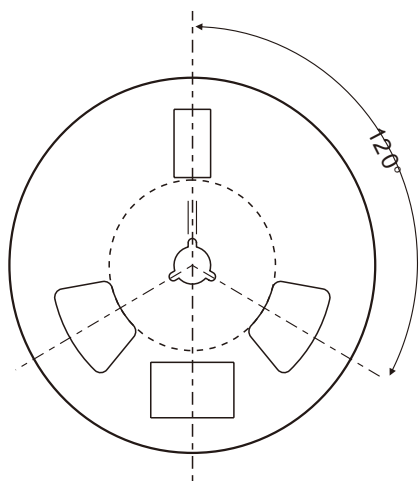
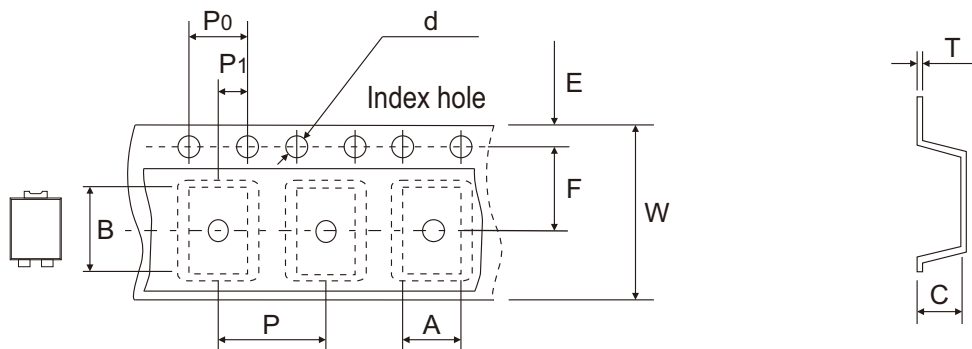

Fig.4 - Typical Reverse Characteristics



## Reel Taping Specification



TO-277B	SYMBOL	A	B	C	d	D	D1	D2
	(mm)	4.30 ± 0.10	6.80 ± 0.10	1.50 ± 0.10	1.55 ± 0.10	330 ± 1.00	75.00 ± 1.00	13.50 ± 0.50
	(inch)	0.169 ± 0.004	0.268 ± 0.004	0.059 ± 0.004	0.061 ± 0.004	12.992 ± 0.039	2.953 ± 0.039	0.531 ± 0.020

TO-277B	SYMBOL	E	F	P	P0	P1	T	W	W1
	(mm)	1.75 ± 0.10	5.50 ± 0.10	8.00 ± 0.10	4.00 ± 0.10	2.00 ± 0.10	0.23 ± 0.05	12.00 ± 0.10	17.00 ± 1.00
	(inch)	0.069 ± 0.004	0.217 ± 0.004	0.315 ± 0.004	0.157 ± 0.004	0.079 ± 0.004	0.009 ± 0.002	0.472 ± 0.004	0.669 ± 0.039

Company reserves the right to improve product design, functions and reliability without notice. REV:A

## Marking Code

Part Number	Marking Code
CDBHA15150-HF	D15SCL



## Suggested PAD Layout

SIZE	TO-277B	
	(mm)	(inch)
A	4.20	0.165
B	4.70	0.185
C	1.27	0.050
D	1.00	0.039
E	6.60	0.260
F	0.90	0.035

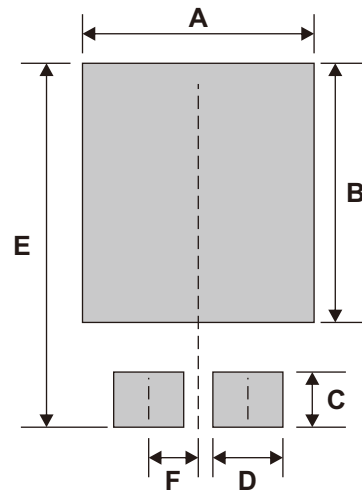

Note: 1. The pad layout is for reference purpose only.

## Standard Packaging

Case Type	REEL PACK	
	REEL (pcs)	Reel Size (inch)
TO-277B	4,000	13