

Chip Power Bead BLE18□□□□SH1D

Murata Standard Reference Specification[AEC-Q200]

1.Scope

This reference specification applies to Chip Power Bead for Automotive Electronics BLE18_SH Series based on AEC-Q200.

2.Part Numbering

| | | | | | | | | | |
|-------|--------------------|-----|-----|--------------------------------|-----|-----|---|-----|-----|
| (ex.) | BL | E | 18 | PS | 080 | S | H | 1 | D |
| | (1) | (2) | (3) | (4) | (5) | (6) | (7) | (8) | (9) |
| | (1)Product ID | | | (4)Characteristics | | | (7)Category(for Automotive Electronics) | | |
| | (2)Type | | | (5)Typical Impedance at 100MHz | | | (8)Numbers of Circuit | | |
| | (3)Dimension (L×W) | | | (6)Performance | | | (9)Packaging (D:Taping) | | |

3.Rating

| Customer Part Number | MURATA Part Number | Impedance (Ω) (at 100MHz)(*1) (refer to below comment) | Rated Current (mA) | | | DC Resistance (Ω max.) (*1) (refer to below comment) | | ESD Rank 2:2kV |
|----------------------|--------------------|--|--------------------|---------|----------|---|----------------------|-------------------|
| | | | Typical | at 85°C | at 125°C | Initial Values | Values After Testing | |
| | BLE18PS080SH1D | 8.5±25% | 8.5 | 8000 | 5000 | 0.004 | 0.005 | 2 |

• Operating Temperature : -55°C to +125°C

• Storage Temperature : -55°C to +125°C

(*1)

Standard Testing Conditions

< Unless otherwise specified >

Temperature : Ordinary Temp. (15 °C to 35 °C)

Humidity : Ordinary Humidity (25%(RH) to 85%(RH))

< In case of doubt >

Temperature : 20°C±2 °C

Humidity : 60%(RH) to 70%(RH)

Atmospheric pressure : 86kPa to 106kPa

(Notes)

Rated Current is derated as right figure depending on the operating temperature.

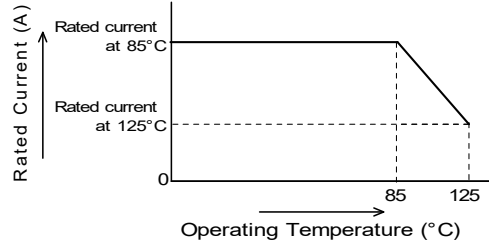

4.Style and Dimensions

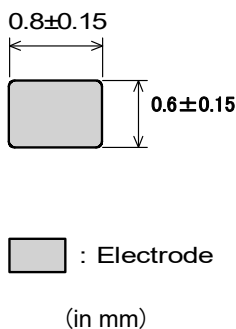
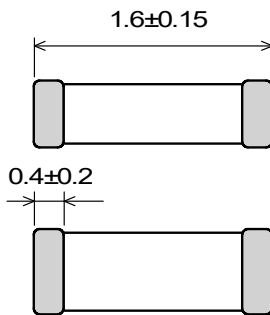

Equivalent Circuit

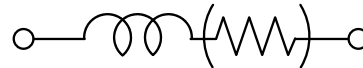

(Resistance element becomes dominant at high frequencies.)

■ Unit Mass (Typical value)
0.004g

5.Marking

No marking.

6.Specifications

6-1.Electrical Performance

| No. | Item | Specification | Test Method |
|-------|---------------|---------------|---|
| 6-1-1 | Impedance | Meet item 3. | Measuring Frequency : 100MHz±1MHz Measuring Equipment : KEYSIGHT 4991A or the equivalent Test Fixture : KEYSIGHT 16192A or the equivalent |
| 6-1-2 | DC Resistance | Meet item 3. | Measuring Equipment : Digital multi meter Measuring Equipment : YOKOGAWA 755611 or the equivalent Test Fixture : KEYSIGHT 16044A or the equivalent * Except resistance of the Substrate and Wire |

6-2. Mechanical Performance(based on Table 13 for FILTER EMI SUPPRESSORS/FILTERS)

AEC-Q200 Rev.D issued June. 1 2010

| AEC-Q200 | | | Murata Specification / Deviation | | | | | | |
|------------------------------|-------------------------------|--|--|------------|-----------|------------------------------|-------------|---------------|--------------|
| No. | Stress | Test Method | | | | | | | |
| 3 | High Temperature Exposure | 1000hours at 125 deg C Set for 24hours at room temperature, then measured. | Meet Table A after testing. <u>Table A</u> <table border="1" style="margin-left: 20px;"> <tr> <td>Appearance</td> <td>No damage</td> </tr> <tr> <td>Impedance Change (at 100MHz)</td> <td>Within ±50%</td> </tr> <tr> <td>DC Resistance</td> <td>Meet item 3.</td> </tr> </table> | Appearance | No damage | Impedance Change (at 100MHz) | Within ±50% | DC Resistance | Meet item 3. |
| Appearance | No damage | | | | | | | | |
| Impedance Change (at 100MHz) | Within ±50% | | | | | | | | |
| DC Resistance | Meet item 3. | | | | | | | | |
| 4 | Temperature Cycling | 1000cycles -55 deg C to +125 deg C Set for 24hours at room temperature, then measured. | Meet Table A after testing. | | | | | | |
| 5 | Destructive Physical Analysis | Per EIA469 No electrical tests | No defects | | | | | | |
| 7 | Biased Humidity | 1000hours at 85 deg C, 85%RH Apply max rated current. | Meet Table A after testing. | | | | | | |
| 8 | Operational Life | Apply 125 deg C 1000hours Set for 24hours at room temperature, then measured | Meet Table A after testing. The operating temperature should be 85 deg C. | | | | | | |
| 9 | External Visual | Visual inspection | No abnormalities | | | | | | |
| 10 | Physical Dimension | Meet ITEM 4 (Style and Dimensions) | No defects | | | | | | |
| 12 | Resistance to Solvents | Per MIL-STD-202 Method 215 | Not Applicable | | | | | | |
| 13 | Mechanical Shock | Per MIL-STD-202 Method 213 Condition F 1500g's (14.7N)/0.5ms/ Half sine | Meet Table B after testing. <u>Table B</u> <table border="1" style="margin-left: 20px;"> <tr> <td>Appearance</td> <td>No damage</td> </tr> <tr> <td>Impedance Change (at 100MHz)</td> <td>Within ±30%</td> </tr> <tr> <td>DC Resistance</td> <td>Meet item 3.</td> </tr> </table> | Appearance | No damage | Impedance Change (at 100MHz) | Within ±30% | DC Resistance | Meet item 3. |
| Appearance | No damage | | | | | | | | |
| Impedance Change (at 100MHz) | Within ±30% | | | | | | | | |
| DC Resistance | Meet item 3. | | | | | | | | |
| 14 | Vibration | 5g's(0.049N) for 20 minutes, 12cycles each of 3 orientations Test from 10-2000Hz. | Meet Table B after testing. | | | | | | |
| 15 | Resistance to Soldering Heat | Solder temperature 260C+/-5 deg C Immersion time 10s | Pre-heating:150C +/-10 deg,60s to 90s Meet Table A after testing. | | | | | | |

| AEC-Q200 | | | Murata Specification / Deviation |
|----------|---------------------------------|--|---|
| No. | Stress | Test Method | |
| 17 | ESD | Per AEC-Q200-002 | Meet Table B after testing. ESD Rank: Meet Item 3. (Rating) |
| 18 | Solderability | Per J-STD-002 | Method b : Not Applicable 95% of the terminations is to be soldered. |
| 19 | Electrical Characterization | Measured : Impedance | No defects |
| 20 | Flammability | Per UL-94 | Not Applicable |
| 21 | Board Flex | Epoxy-PCB(1.6mm) Deflection 2mm(min) 60s minimum holding tim | Meet Table A after testing. |
| 22 | Terminal Strength | Per AEC-Q200-006 | No defects |
| 30 | Electrical Transient Conduction | Per ISO-7637-2 | Not Applicable |

7.Specification of Packaging

7-1.Appearance and Dimensions (8mm-wide paper tape)

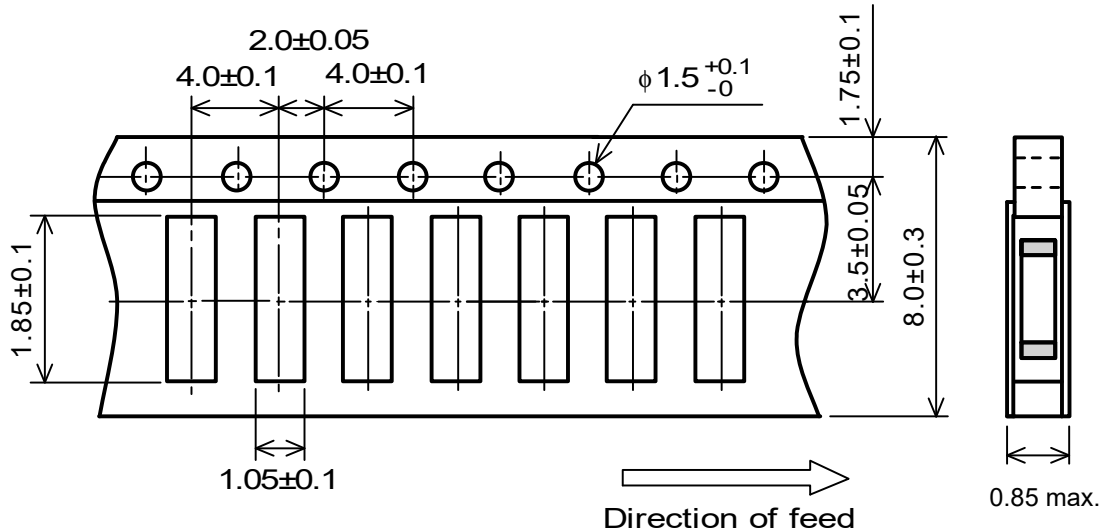

(in mm)

(1) Taping

Products shall be packaged in the cavity of the base tape of 8mm-wide,4mm-pitch continuously and sealed by top tape and bottom tape.

(2) The sprocket holes are to the right as the tape is pulled toward the user.

(3) Spliced point:The base tape and top tape have no spliced point

(4) Cavity:There shall not be burr in the cavity.

(5) Missing components number

Missing components number within 0.025% of the number per reel or 1 pc., whichever is greater, and are not continuous. The specified quantity per reel is kept.

8. ⚠ Caution

8-1.Rating

Do not use products beyond the Operating Temperature Range and Rated Current.

8-2.Surge current

Excessive surge current (pulse current or rush current) than specified rated current applied to the product may cause a critical failure, such as an open circuit, burnout caused by excessive temperature rise. Please contact us in advance in case of applying the surge current.

8-3.Fail Safe

Be sure to provide an appropriate fail-safe function on your product to prevent from a second damage that may be caused by the abnormal function or the failure of our products.

8-4.Limitation of Applications

Please contact us before using our products for the applications listed below which require especially high reliability for the prevention of defects which might directly cause damage to the third party's life, body or property.

- | | |
|----------------------------------|---|
| (1)Aircraft equipment | (6)Disaster prevention / crime prevention equipment |
| (2)Aerospace equipment | (7)Traffic signal equipment |
| (3)Undersea equipment | (8)Transportation equipment (trains,ships,etc.) |
| (4)Power plant control equipment | (9)Data-processing equipment |
| (5)Medical equipment | (10)Applications of similar complexity and /or reliability requirements to the applications listed in the above |

8-5.Corrosive gas

Please refrain from use since contact with environments with corrosive gases (sulfur gas [hydrogen sulfide, sulfur dioxide, etc.], chlorine, ammonia, etc.) or oils (cutting oil, silicone oil, etc.) that have come into contact with the previously stated corrosive gas environment will result in deterioration of product quality or an open from deterioration due to corrosion of product electrode, etc. We will not bear any responsibility for use under these environments.

9. Notice

This product is designed for solder mounting.

Please consult us in advance for applying other mounting method such as conductive adhesive.

Cracks may occur at the connection of solder (solder fillet portion) due to the difference of the coefficient of thermal expansion from a mounting board when heat stress like heat cycle, etc. are repeatedly given to them.

The occurrence of the crack by heat stress may be influenced by the size of a pad, solder volume, heat radiation of mounting board etc., so please pay careful attention to designing when a big change in ambient temperature can be assumed.

9-1.Land pattern designing

- Standard land dimensions

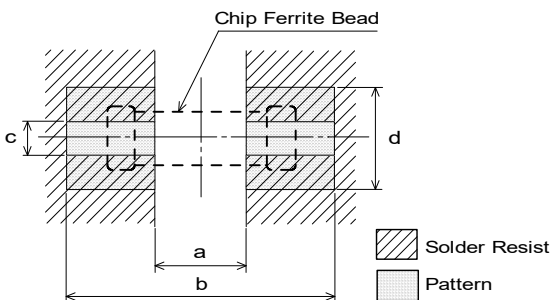

| Soldering | a | b | c | Land pad thickness and dimension d | | |
|-------------|------------------------------|------------------------------|-----|------------------------------------|------|------|
| | | | | 18μm | 35μm | 70μm |
| Flow/Reflow | Flow 0.8 Reflow 0.7 | Flow 2.5 Reflow 2.0 | 0.7 | - | 6.4 | 3.3 |

(in mm)

*The excessive heat by land pads may cause deterioration at joint of products with substrate.

9-2.Soldering Conditions

Products can be applied to reflow and flow soldering.

(1) Flux,Solder

| | |
|--------|--|
| Flux | Use rosin-based flux, but not highly acidic flux (with chlorine content exceeding 0.2(wt)%.) Do not use water-soluble flux. |
| Solder | Use Sn-3.0Ag-0.5Cu solder Standard thickness of solder paste : 100 μm to 200 μm |

(2) Soldering conditions

- Pre-heating should be in such a way that the temperature difference between solder and ferrite surface is limited to 150°C max. Also cooling into solvent after soldering should be in such a way that the temperature difference is limited to 100°C max.
Insufficient pre-heating may cause cracks on the ferrite, resulting in the deterioration of product quality.
- Standard soldering profile and the limit soldering profile is as follows.
The excessive limit soldering conditions may cause leaching of the electrode and / or resulting in the deterioration of product quality.

(3)Soldering profile

Flow soldering profile

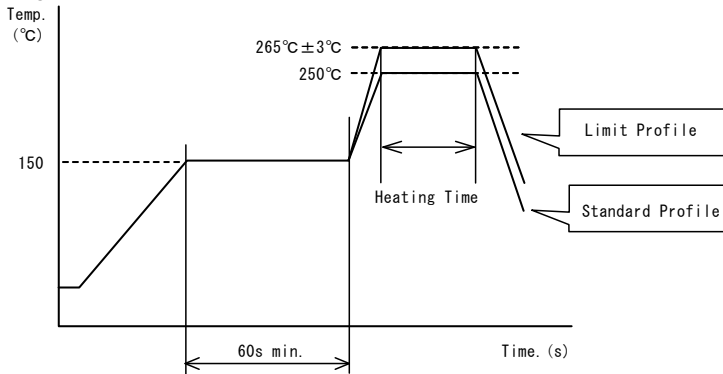

| | Standard Profile | Limit Profile |
|---------------|------------------|-------------------|
| Pre-heating | 150°C、60s min. | |
| Heating | 250°C、4~6s | 265°C±3°C、5s max. |
| Cycle of flow | 2 times | 2 times |

Reflow soldering profile

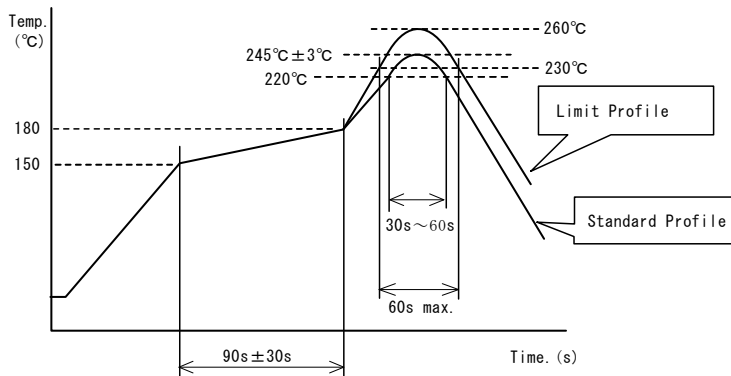

| | Standard Profile | Limit Profile |
|------------------|---------------------|----------------------|
| Pre-heating | 150~180°C、90s±30s | |
| Heating | above 220°C、30s~60s | above 230°C、60s max. |
| Peak temperature | 245±3°C | 260°C,10s |
| Cycle of reflow | 2 times | 2 times |

9-3.Reworking with soldering iron

- Pre-heating: 150°C, 1 min
- Tip temperature: 350°C max.
- Soldering time : 3(+1,-0) seconds.
- Soldering iron output: 80W max.
- Tip diameter: φ 3mm max.
- Times : 2times max.

Note :Do not directly touch the products with the tip of the soldering iron in order to prevent the crack on the ferrite material due to the thermal shock.

9-4.Solder Volume

Solder shall be used not to be exceeded as shown below.

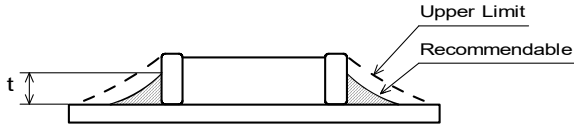

$$1/3T \leq t \leq T$$

(T:Chip thickness)

Accordingly increasing the solder volume, the mechanical stress to product is also increased. Exceeding solder volume may cause the failure of mechanical or electrical performance.

9-5.Attention regarding P.C.B. bending

The following shall be considered when designing and laying out P.C.B.'s.

- (1) P.C.B. shall be designed so that products are not subject to the mechanical stress for board warpage.

<Products direction>

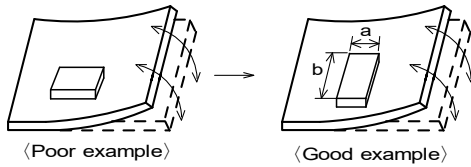

Products shall be located in the sideways direction (Length:a<b) to the mechanical stress.

- (2)Components location on P.C.B. separation.

It is effective to implement the following measures, to reduce stress in separating the board.

It is best to implement all of the following three measures; however, implement as many measures as possible to reduce stress.

| Contents of Measures | Stress Level |
|--|--------------|
| (1) Turn the mounting direction of the component parallel to the board separation surface. | A > D *1 |
| (2) Add slits in the board separation part. | A > B |
| (3) Keep the mounting position of the component away from the board separation surface. | A > C |

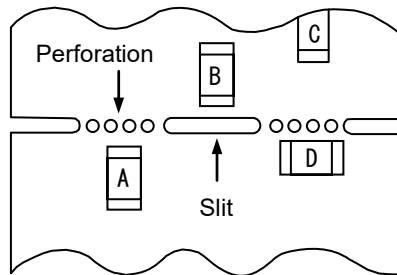

*1 A > D is valid when stress is added vertically to the perforation as with Hand Separation. If a Cutting Disc is used, stress will be diagonal to the PCB, therefore A > D is invalid.

- (3) Mounting Components Near Screw Holes

When a component is mounted near a screw hole, it may be affected by the board deflection that occurs during the tightening of the screw. Mount the component in a position as far away from the screw holes as possible.

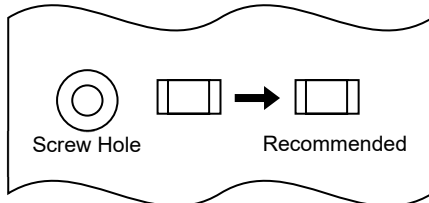

9-6. Mounting density

Add special attention to radiating heat of products when mounting the inductor near the products with heating. The excessive heat by other products may cause deterioration at joint of this product with substrate.

9-7. Operating Environment

Do not use this product under the following environmental conditions, on deterioration of the Insulation Resistance of the Ferrite material and/or corrosion of Inner Electrode may result from the use.

- (1) in the corrodible atmosphere such as acidic gases, alkaline gases, chlorine, sulfur gases, organic gases and etc. (the sea breeze, Cl₂, H₂S, NH₃, SO₂, NO₂, etc)
- (2) in the atmosphere where liquid such as organic solvent, may splash on the products.
- (3) in the atmosphere where the temperature / humidity changes rapidly and it is easy to dew.

9-8. Resin coating

The impedance value may change and/or it may affect on the product's performance due to high cure-stress of resin to be used for coating / molding products. So please pay your careful attention when you select resin. In prior to use, please make the reliability evaluation with the product mounted in your application set.

9-9. Cleaning

Excessive ultrasonic oscillation during cleaning can cause the PCBs to resonate, resulting in cracked chips or broken solder joints. Before starting your production process, test your cleaning equipment / process to insure it does not degrade this product.

9-10. Handling of a substrate

After mounting products on a substrate, do not apply any stress to the product caused by bending or twisting to the substrate when cropping the substrate, inserting and removing a connector from the substrate or tightening screw to the substrate.

Excessive mechanical stress may cause cracking in the product.

Bending

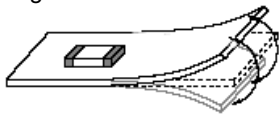

Twisting

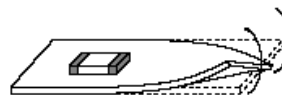

9-11. Storage Conditions

(1) Storage period

Use the products within 6 months after delivered.

Solderability should be checked if this period is exceeded.

(2) Storage conditions

- Products should be stored in the warehouse on the following conditions.

Temperature : -10°C to 40°C

Humidity : 15% to 85% relative humidity

No rapid change on temperature and humidity

- Don't keep products in corrosive gases such as sulfur, chlorine gas or acid, or it may cause oxidization of electrode, resulting in poor solderability.
- Products should be stored on the palette for the prevention of the influence from humidity, dust and so on.
- Products should be stored in the warehouse without heat shock, vibration, direct sunlight and so on.
- Avoid storing the product by itself bare (i.e. exposed directly to air).

(3) Delivery

Care should be taken when transporting or handling product to avoid excessive vibration or mechanical shock.

10. Note

- (1) Please make sure that your product has been evaluated in view of your specifications with our product being mounted to your product.
- (2) You are requested not to use our product deviating from the agreed specifications.
- (3) The contents of this reference specification are subject to change without advance notice. Please approve our product specifications or transact the approval sheet for product specifications before ordering.