



Features:

- Universal AC input/ Full Range
- Energy Efficiency Level VI
- Output Protections: SCP/OC
- No Load Power Consumption <0.1W
- 1 Year Warranty



Model	QFWB-10-5	QFWB-10-5.9	QFWB-10-7	QFWB-10-8	QFWB-10-9	QFWB-10-10	QFWB-10-12	QFWB-10-15	QFWB-10-18	QFWB-10-24	QFWB-10-28	QFWB-10-30	QFWB-10-36
Output Characteristics													
DC Output	5V	5.9V	7V	8V	9V	10V	12V	15V	18V	24V	28V	30V	36V
Rated Current	2.1A	2.0A	1.71A	1.50A	1.33A	1.20A	1.00A	0.80A	0.66A	0.50A	0.35A	0.40A	0.33A
Ripple and Noise	200mV Max												
Load Regulation (Typ.)	±5%												
Turn On Delay	3S Max												
Hold-up Time (Typ.)	10mS @ Rated Load 115VAC, 20mS @ Rated Load 230VAC												
Output Protection	Short Circuit, Over Current												
Ferrite Core	No												
Input Characteristics													
Voltage Range	100VAC~240VAC												
Frequency Range	50Hz-60Hz												
Efficiency	DoE Level VI, Energy Star												
AC Current (max)	0.3A												
Input Protection	Internal Primary Current Fuse, Inrush Limiting												
Leakage Current	0.25mA @ 264VAC/50Hz												
Environmental Characteristics													
Operating Temperature	0°C~40°C												
Operating Relative Humidity	10% RH to 80% RH												
Storage Temperature	-20°C~80°C, 5% RH to 95% RH												
Topology	Switching Flyback												
Dielectric Withstand	3000VAC/10mA Primary-Secondary												
EMI Conduction & Radiation	Compliance to EN55022 Class B, FCC Part 15 Class B												
Harmonic Current	Compliance to EN61000-3-2, 3												
EMS Immunity	Compliance to IEC61000-4-2, 3, 4, 5, 6, 8, 11												
Characteristics													
MTBF	50,000Hrs (25°C, Telecordia SR-332)												
Dimension (LxWxH)	59x40.9x26.5mm												
Weight	87g												

PART NUMBER SYSTEM

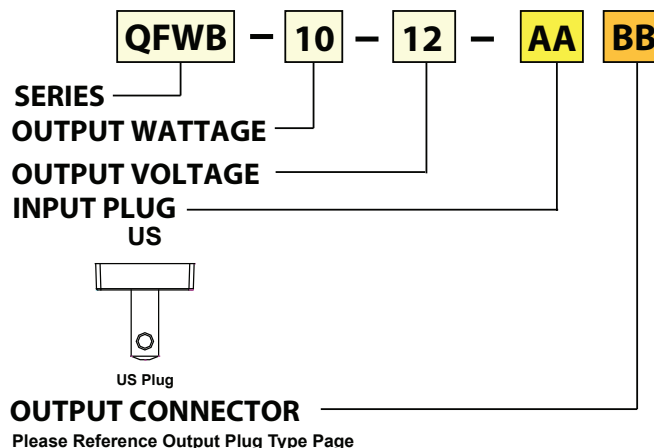

MECHANICAL SPECIFICATIONS

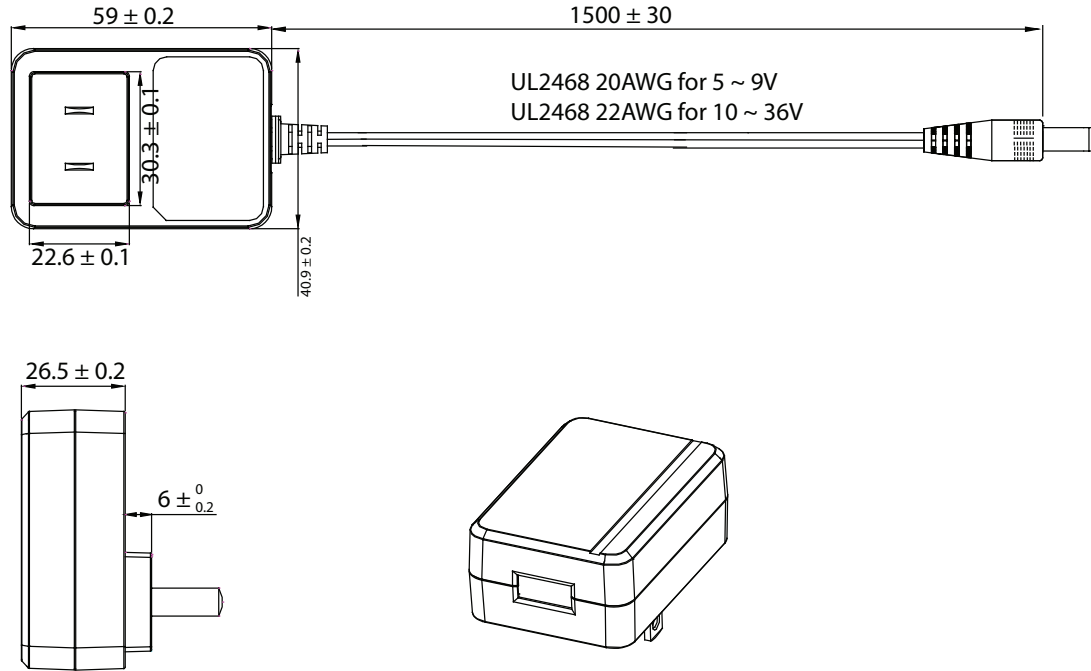

DERATING CURVE

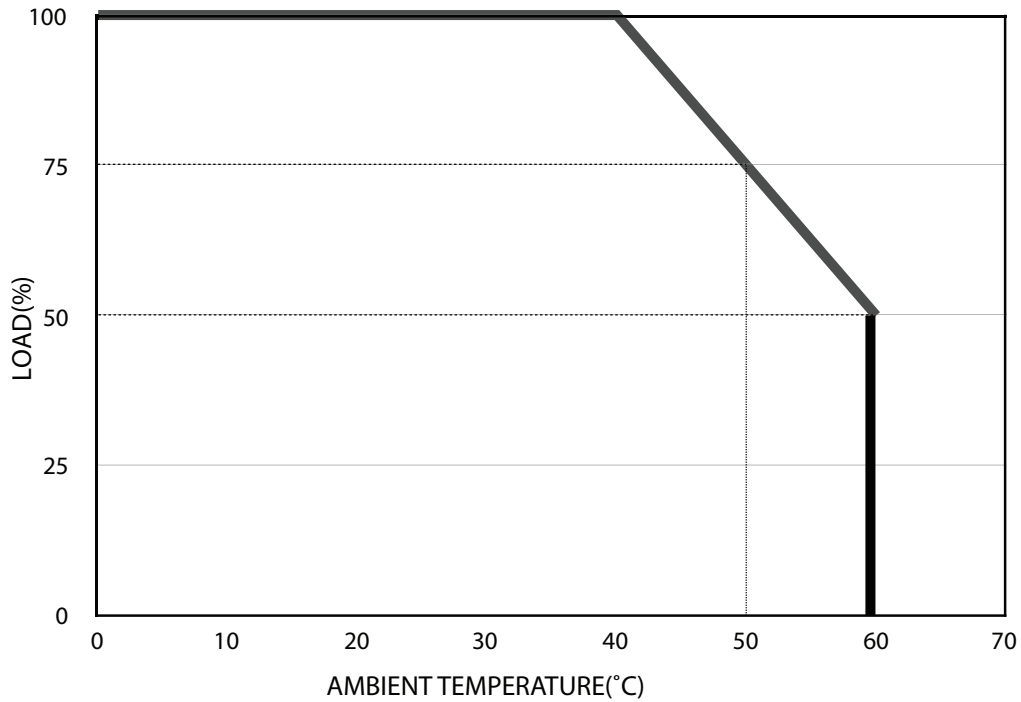

UNIT: mm