

QT-Brightek Chip LED Series

SMD 1205 Tri-Color LED

Part No.: QBLP655R-RGB

R: Red

G: True Green

B: Blue

Product: QBLP655R-RGB	Date: November 27, 2018	Page 1 of 11
	Version# 1.2	

Table of Contents:

Introduction	3
Electrical / Optical Characteristic (Ta=25 °C)	4
Absolute Maximum Rating	4
Characteristic Curves.....	6
Solder Profile & Footprint.....	8
Packing	9
Labeling	10
Ordering Information	10
Revision History	11
Disclaimer	11

Introduction

Feature:

- Clear lens
- Package in tape and reel
- Ultra bright 1205 package
- InGaN technology for True Green (G) and Blue (B)
- AlInGaP technology for R
- Viewing angle: 140 degrees
- Reverse Mountable

Description:f

These ultra-bright 655R LEDs have a height profile of 1.10mm. With a combination of high brightness output and small footprint, these LEDs are ideal for keypad backlighting and status indication.

Application:

- Status indication
- Back lighting application

Certification & Compliance:

- TS16949
- ISO9001
- RoHS Compliant



Dimension:

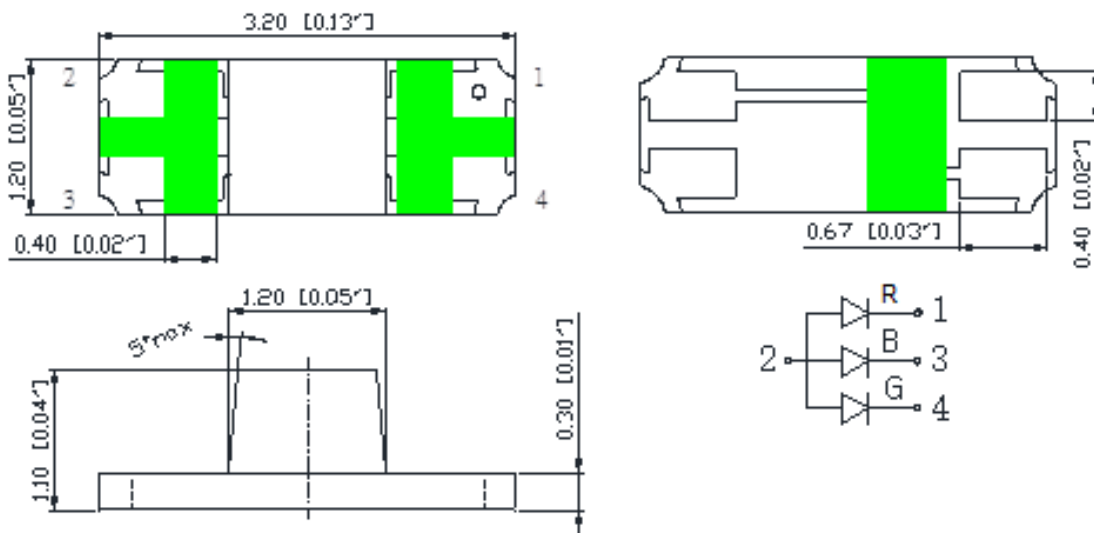

Units: mm / tolerance = +/-0.1mm

Electrical / Optical Characteristic (Ta=25 °C)

Product	Color	I _F (mA)	V _F (V)		λ _D (nm)			I _V (mcd)	
			Typ.	Max.	Min.	Typ.	Max.	Min.	Typ.
QBLP655R-RGB	Red	20	2.0	2.5	615	623	630	50	90
	True Green	20	3.1	3.7	515	520	525	250	450
	Blue	20	3.1	3.7	465	470	475	50	95

Absolute Maximum Rating

Material	P _d (mW)	I _F (mA)	I _{FP} (mA)*	V _R (V)	T _{OP} (°C)	T _{ST} (°C)	T _{SOL} (°C)**
AllnGaP (R)	75	30	125	5	-40 ~ +85	-40 ~ +100	260
InGaN (G/B)	120	30	125	5	-40 ~ +85	-40 ~ +100	260

*Duty 1/8 @ 1kHz

**IR Reflow for no more than 10 sec @ 260 °C

Forward Voltage V_F for AllnGaP @ I_F=20mA

Bin	Min.	Max.	Unit
□	1.7	2.5	V

Forward Voltage V_F for InGaN @ I_F=20mA

Bin	Min.	Max.	Unit
f	2.8	3.1	V
g	3.1	3.4	
h	3.4	3.7	

Luminous Intensity I_V @ $I_F=20mA$

Bin	Min.	Max.	Unit
G	50	63	mcd
H	63	80	
I	80	100	
J	100	125	
K	125	160	
L	160	200	
M	200	250	
N	250	320	
O	320	400	
P	400	500	
Q	500	630	
R	630	800	

Dominant Wavelength λ_D for Red @ $I_F=20mA$

Bin	Min.	Max.	Unit
s	615	620	nm
t	620	625	
u	625	630	

Dominant Wavelength λ_D for True Green @ $I_F=20mA$

Bin	Min.	Max.	Unit
S	515	517.5	nm
T	517.5	520	
U	520	522.5	
V	522.5	525	

Dominant Wavelength λ_D for Blue @ $I_F=20mA$

Bin	Min.	Max.	Unit
G	465	467.5	nm
H	467.5	470	
I	470	472.5	
J	472.5	475	

Note:

Tolerance of measurement of forward voltage: $\pm 0.1V$

Tolerance of measurement of luminous intensity: $\pm 15\%$

Tolerance of measurement of dominant wavelength: $\pm 2nm$

Characteristic Curves

AllInGaP (R)

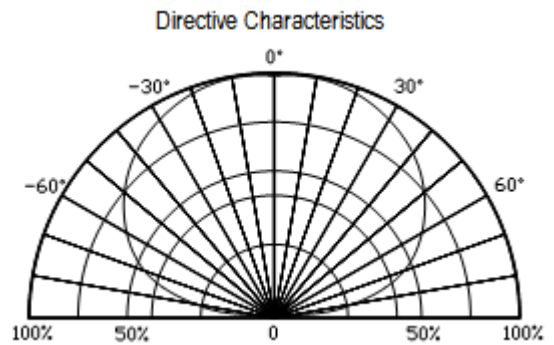
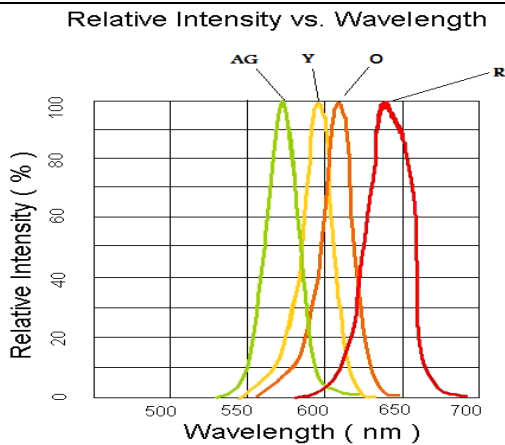
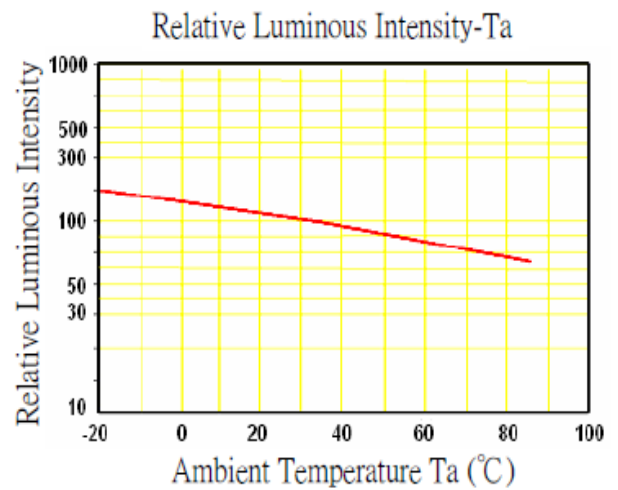
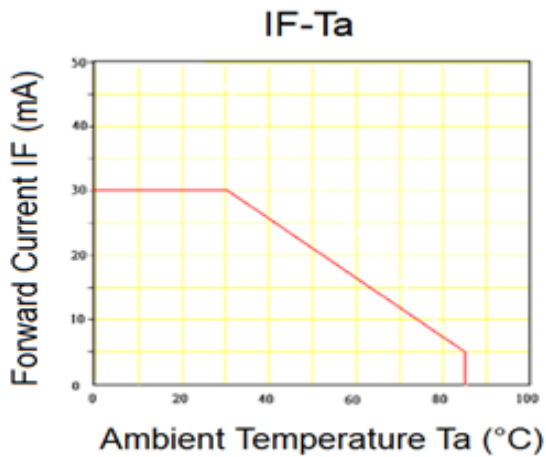
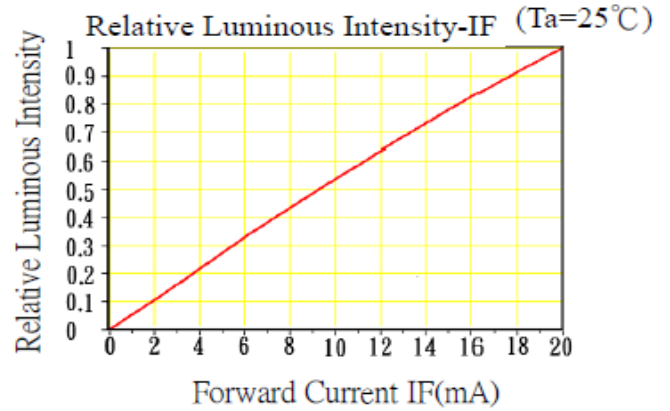
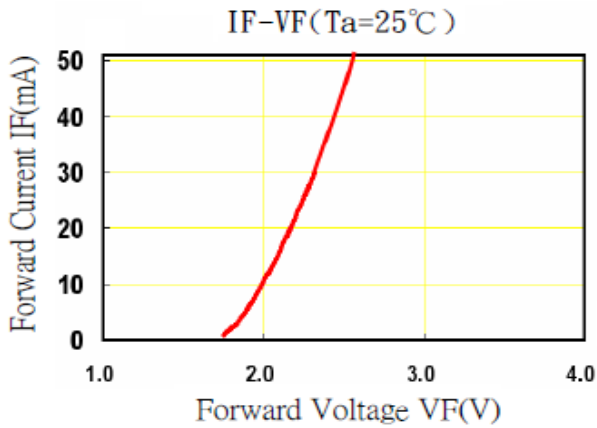

InGaN (G/B)

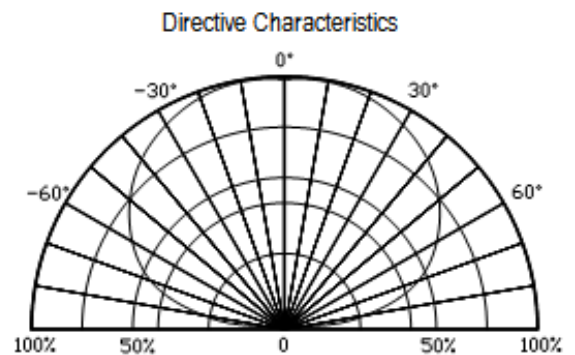
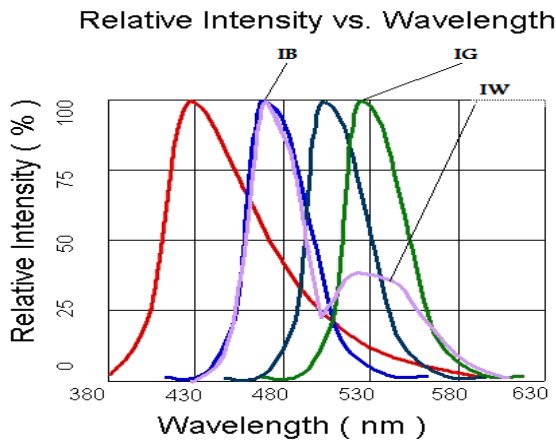
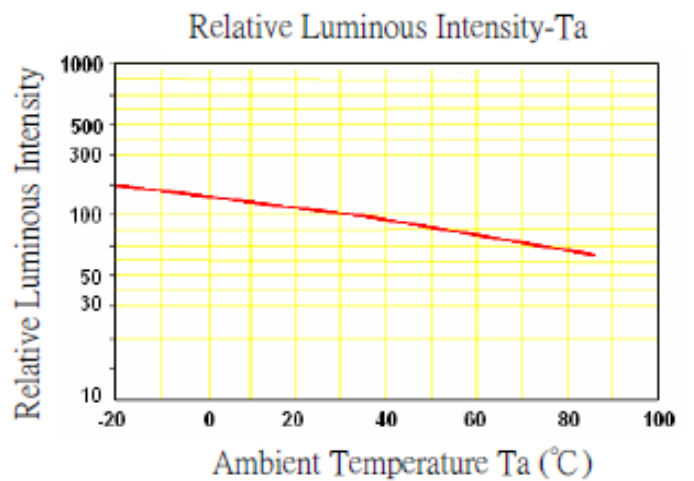
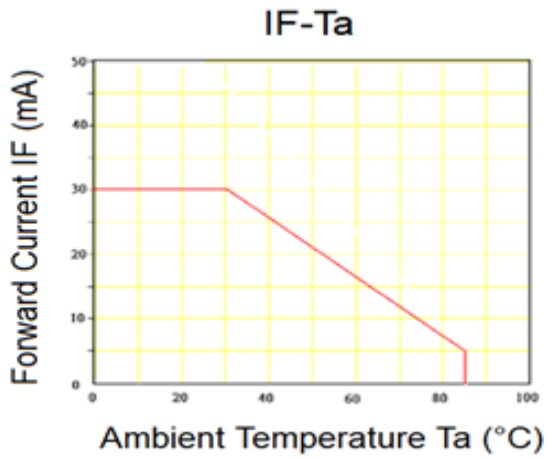
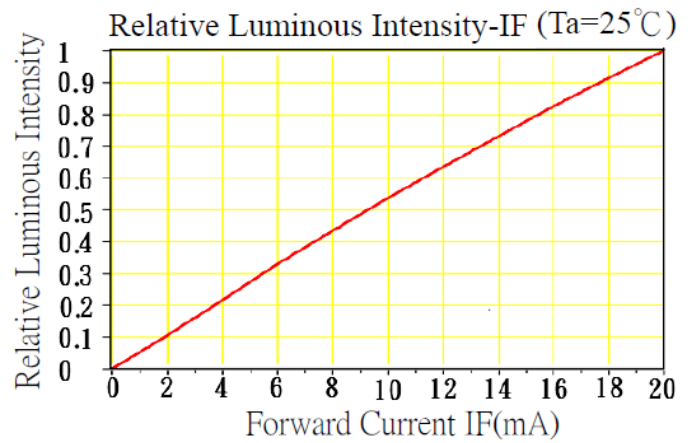
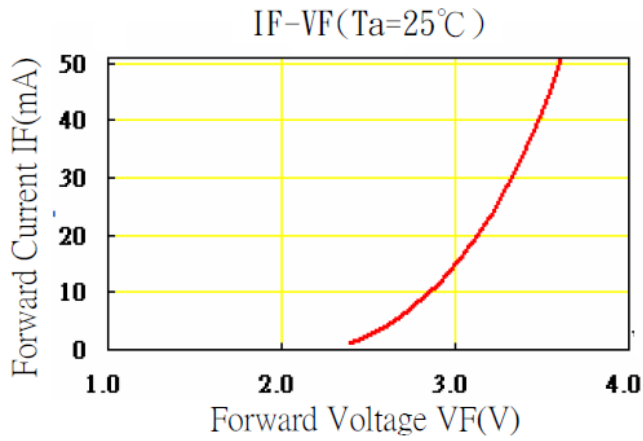

Solder Profile & Footprint

-The recommended reflow soldering profile is as follows (temperatures indicated are as measured on the surface of the LED resin):

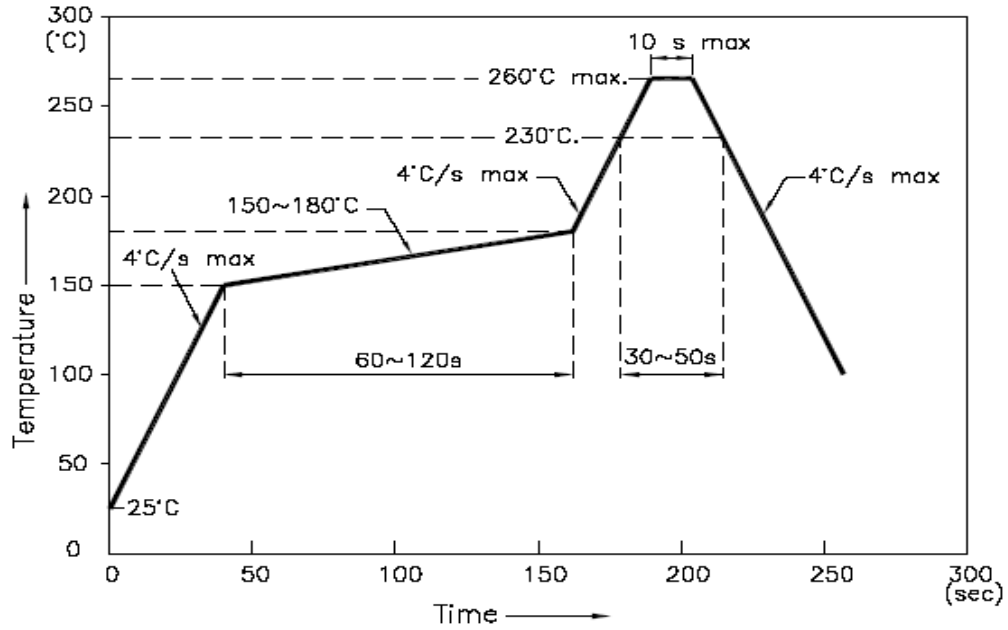

Recommended Pad Layout

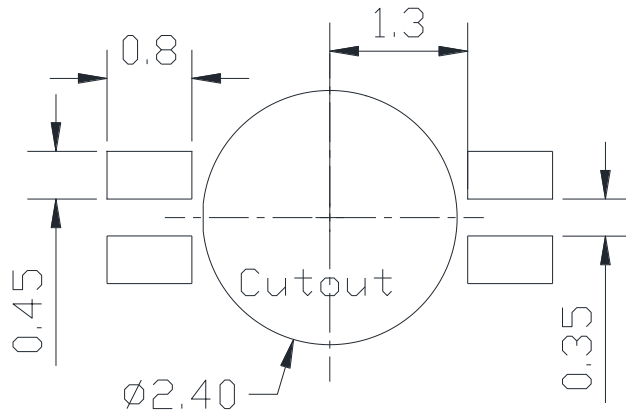

Units: mm

tolerance: +/- 0.1mm

Labeling

Part No: _____

Customer P/N: _____

Item: _____

Q'ty: _____

Vf: _____

Iv: _____

WI: _____

Date: _____

Made in China**Ordering Information**

Part #	Orderable Part #	Spec Range	Quantity per reel
QBLP655R-RGB	QBLP655R-RGB	R: Iv=90mcd typ. @ 20mA / $\lambda_D=615-630\text{nm}$	1000 units
		G: Iv=450mcd typ. @ 20mA / $\lambda_D=515-525\text{nm}$	
		B: Iv=95mcd typ. @ 20mA / $\lambda_D=465-475\text{nm}$	

Revision History

Description:	Revision #	Revision Date
New Release of QBLP655R-RGB	V1.0	06/28/2017
Update logo	V1.1	11/05/2018
Update packing spec to 1K/reel	V1.2	11/27/2018

Disclaimer

QT-BRIGHTTEK reserves the right to make changes without further notice to any products herein to improve reliability, function or design. QT-BRIGHTTEK does not assume any liability arising out of the application or use of any product or circuit described herein; neither does it convey any license under its patent rights, nor the rights of others.

Life Support Policy

QT-BRIGHTTEK's products are not authorized for use as critical components in life support devices or systems without the express written approval of QT-BRIGHTTEK. As used herein:

1. Life support devices or systems are devices or systems which, (a) are intended for surgical implant into the body, or (b) support or sustain life, and (c) whose failure to perform when properly used in accordance with instructions for use provided in the labeling, can be reasonably expected to result in a significant injury of the user.
2. A critical component in any component of a life support device or system whose failure to perform can be reasonably expected to cause the failure of the life support device or system, or to affect its safety or effectiveness.