

QT-Brightek Chip LED Series

SMD Side View 0802 LED

Part No.: QBLP612 Series

Table of Contents:

Introduction	3
Electrical / Optical Characteristic (Ta=25 °C)	4
Absolute Maximum Rating	4
CIE Chromaticity Diagram.....	6
Characteristic Curves.....	7
Solder Profile & Footprint.....	9
Packing	10
Labeling	11
Ordering Information	11
Revision History	12
Disclaimer	12

Introduction

Feature:

- Water clear lens (except for white color)
- Yellow lens for White
- Package in tape and reel
- Side View Ultra bright 0802 LED package
- AllInGaP technology for R/Y/AG
- InGaN technology for IG/IW
- Viewing Angle = 150° typ.

Description:

These ultra bright 0802 LEDs have a height profile of 0.6mm. With higher packing density and smaller footprint, these LEDs are ideal for smaller equipment and miniature application.

Application:

- Status indication
- Back lighting application
- General Use

Certification & Compliance:

- TS16949
- ISO9001
- RoHS Compliant



Dimension:

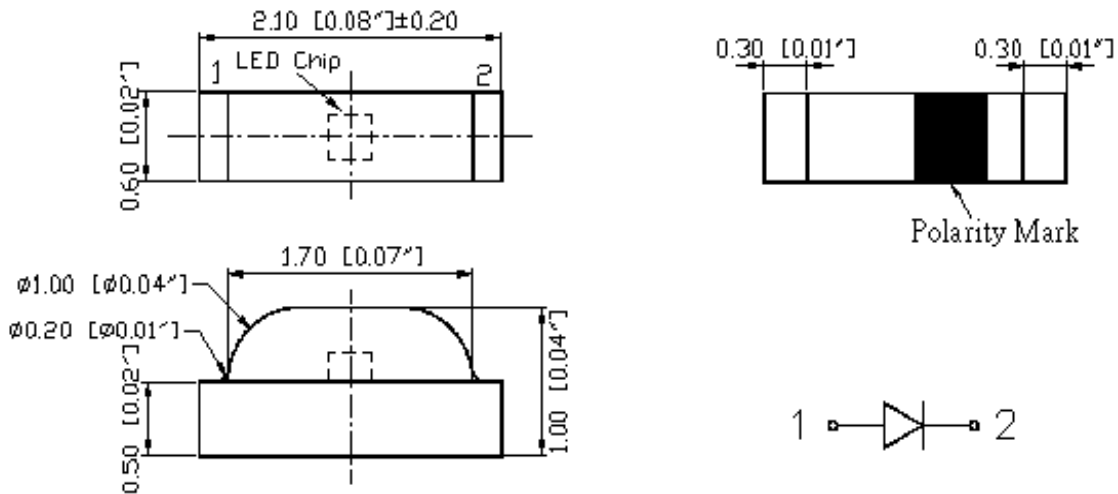

Units: mm / tolerance = +/-0.1mm

Electrical / Optical Characteristic (Ta=25 °C)

Product	Color	I _F (mA)	V _F (V)		λ _D (nm)			I _V (mcd)	
			Typ.	Max.	Min.	Typ.	Max.	Min.	Typ.
QBLP612-R	Red	20	2.0	2.5	625	630	635	40	70
QBLP612-Y	Yellow	20	2.0	2.5	585	590	595	63	110
QBLP612-AG	Yellow Green	20	2.0	2.5	565	570	576	25	40
QBLP612-IG	True Green	20	3.2	3.7	520	525	530	250	430
QBLP612-IW-CW	Cool White	20	3.2	3.7	X=0.25 Y=0.24	-	X=0.33 Y=0.34	160	320

Absolute Maximum Rating

Material	P _d (mW)	I _F (mA)	I _{FP} (mA)*	V _R (V)	T _{OP} (°C)	T _{ST} (°C)	T _{SOL} (°C)**
AllnGaP	75	30	125	5	-40 to +80	-40 to +85	260
InGaN	111	30	125	5	-40 to +80	-40 to +85	260

*Duty 1/8 @ 1kHz

**IR Reflow for no more than 10 sec @ 260 °C

Forward Voltage V_F for AllnGaP @ I_F=20mA

Bin	Min.	Max.	Unit
□	1.7	2.5	V

Forward Voltage V_F for InGaN @ I_F=20mA

Bin	Min.	Max.	Unit
f	2.8	3.1	V
g	3.1	3.4	
h	3.4	3.7	

Luminous Intensity IV @ IF=20mA

Bin	Min.	Max.	Unit
D	25	32	mcd
E	32	40	
F	40	50	
G	50	63	
H	63	80	
I	80	100	
J	100	125	
K	125	160	
L	160	200	
M	200	250	
N	250	320	
O	320	400	
P	400	500	
Q	500	630	
R	630	800	

Dominant Wavelength λ_D for Red @ IF=20mA

Bin	Min.	Max.	Unit
u	625	630	nm
v	630	635	

Dominant Wavelength λ_D for Yellow @ IF=20mA

Bin	Min.	Max.	Unit
m	585	590	nm
n	590	595	

Dominant Wavelength λ_D for Yellow Green @ IF=20mA

Bin	Min.	Max.	Unit
h	565	568	nm
i	568	572	
j	572	576	

Dominant Wavelength λ_D for True Green @ IF=20mA

Bin	Min.	Max.	Unit
U	520	522.5	nm
V	522.5	525	
W	525	527.5	
X	527.5	530	

CIE Chromaticity Diagram

Chromaticity Diagram

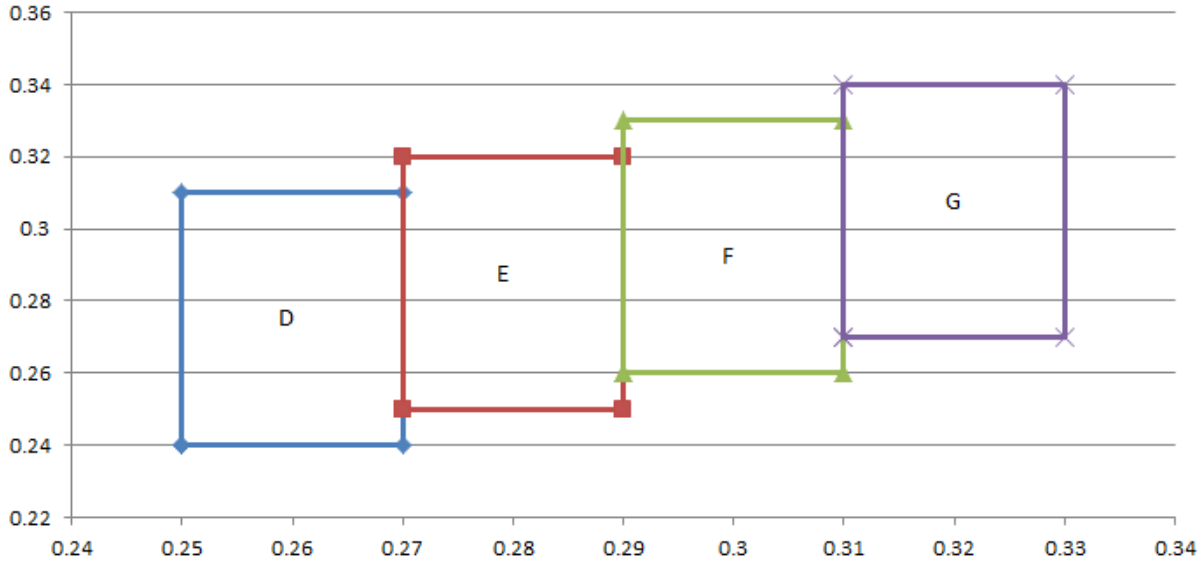

D		E		F		G	
0.25	0.24	0.27	0.25	0.29	0.26	0.31	0.27
0.25	0.31	0.27	0.32	0.29	0.33	0.31	0.34
0.27	0.31	0.29	0.32	0.31	0.33	0.33	0.34
0.27	0.24	0.29	0.25	0.31	0.26	0.33	0.27
0.25	0.24	0.27	0.25	0.29	0.26	0.31	0.27

Characteristic Curves

AllnGaP Technology (R/Y/AG)

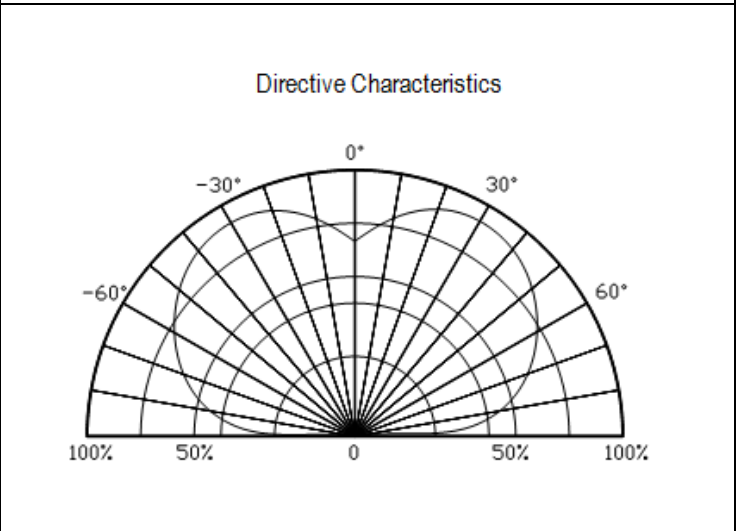
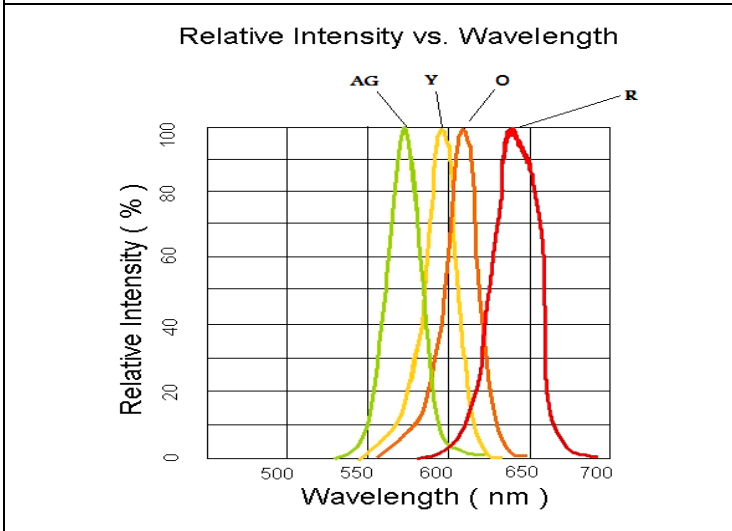
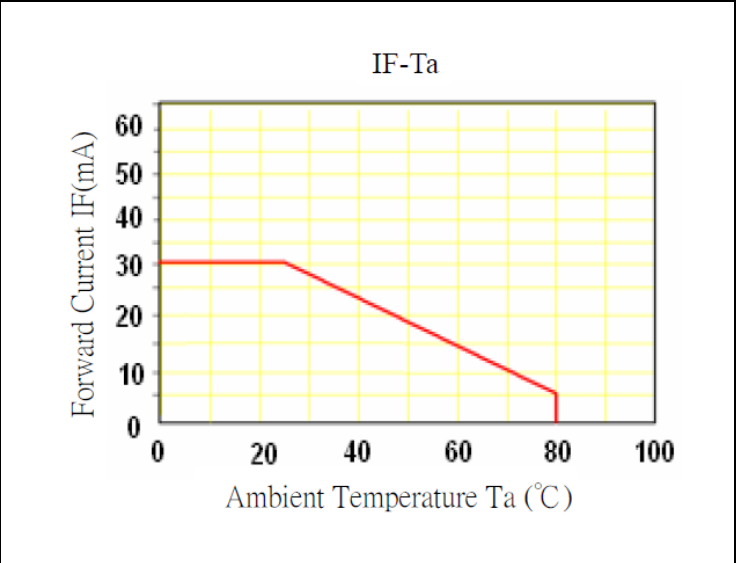
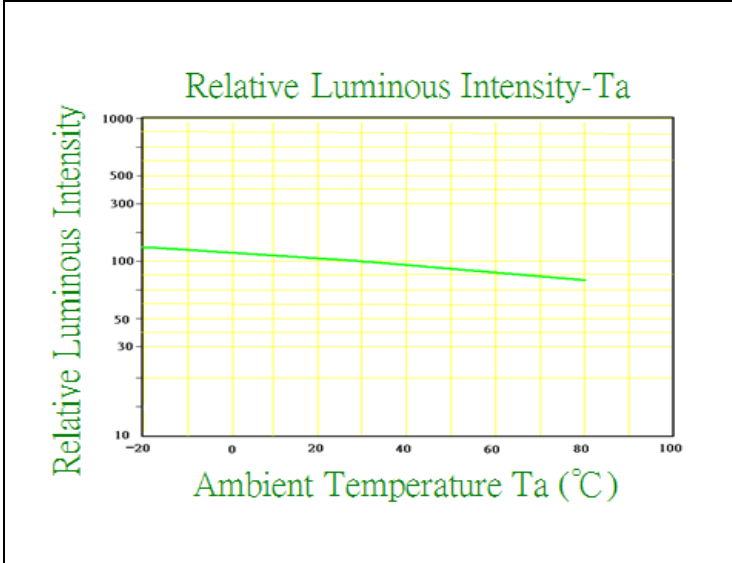
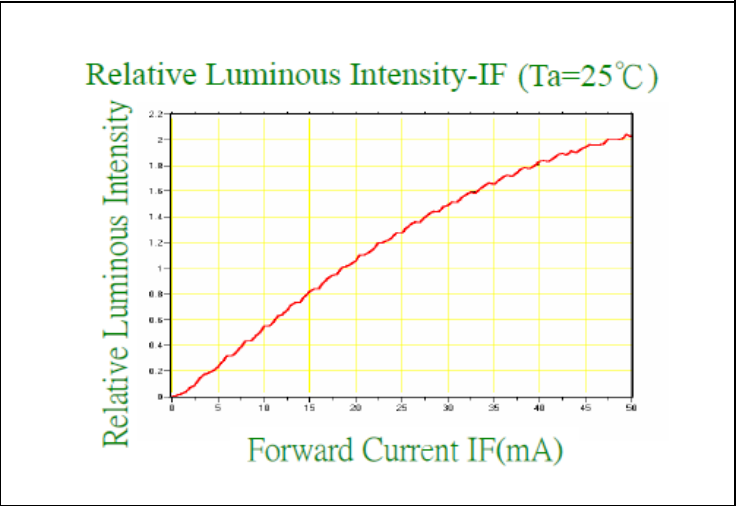
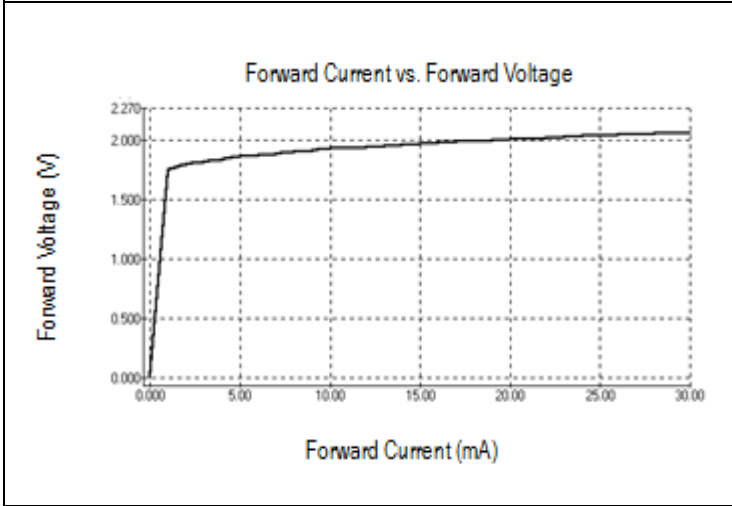

InGaN Technology (IB/IG/IW)

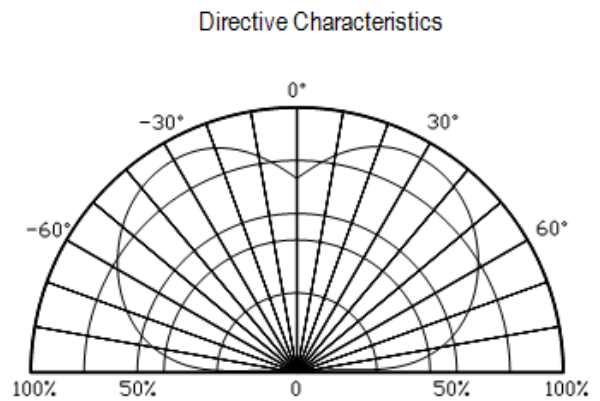
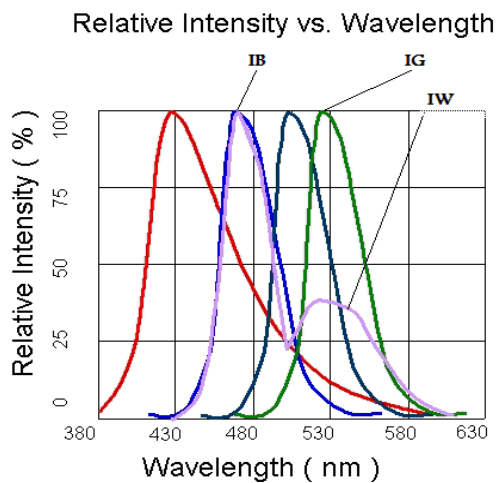
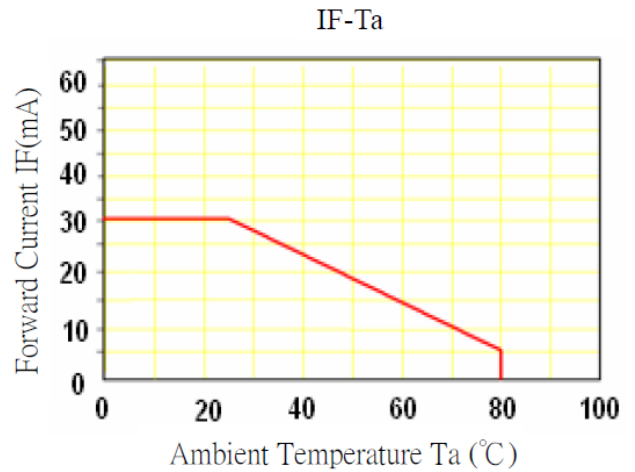
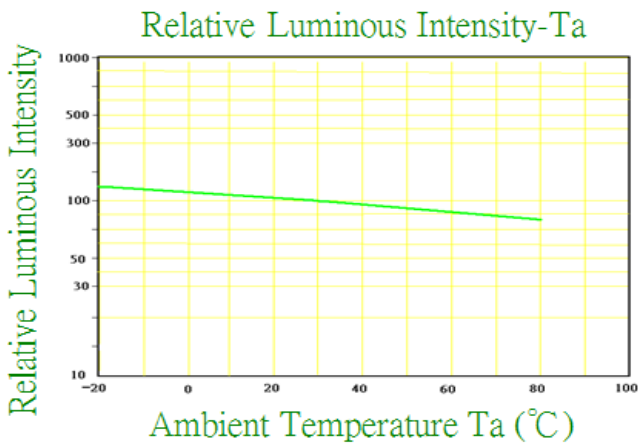
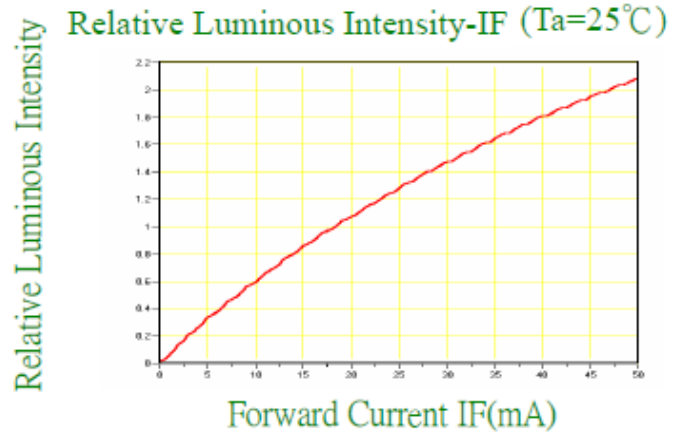
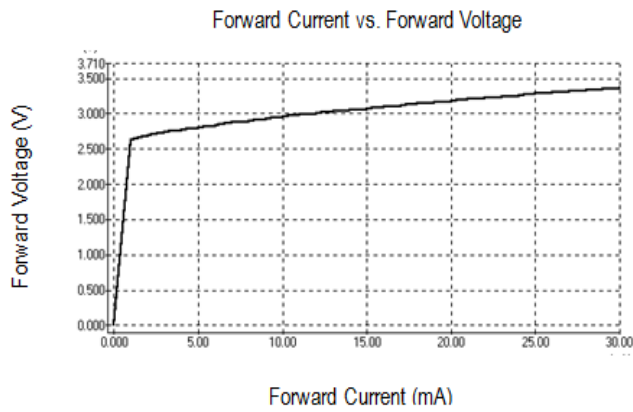

Solder Profile & Footprint

-The recommended reflow soldering profile is as follows (temperatures indicated are as measured on the surface of the LED resin):

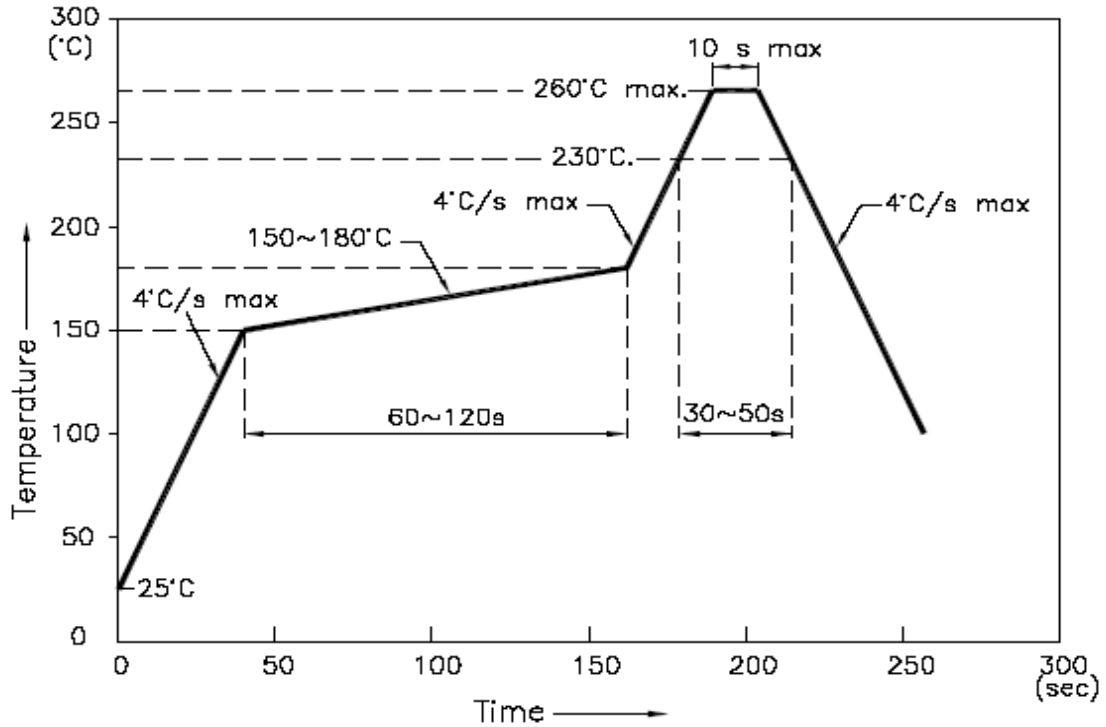

Recommended Pad Layout

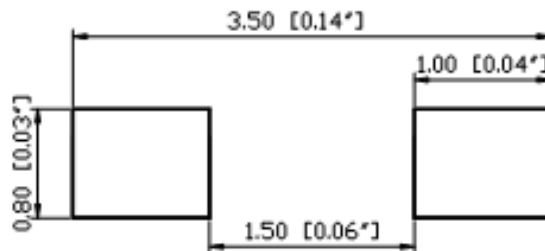

Units: mm

Tolerance: ± 0.1mm

Packing

Reel Dimension:

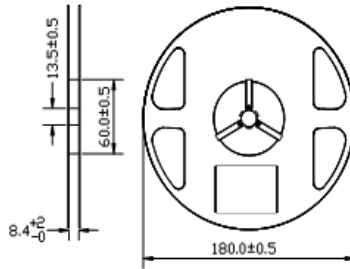

Unit: mm

Tape Dimension:

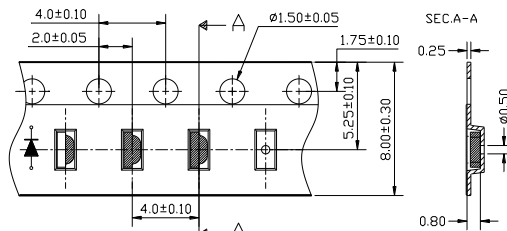

Unit: mm

Arrangement of Tape:

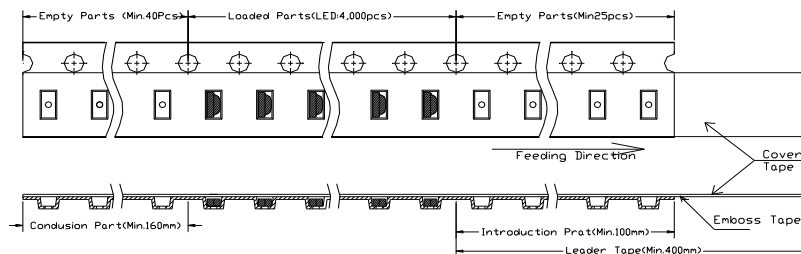

Packaging Specifications:

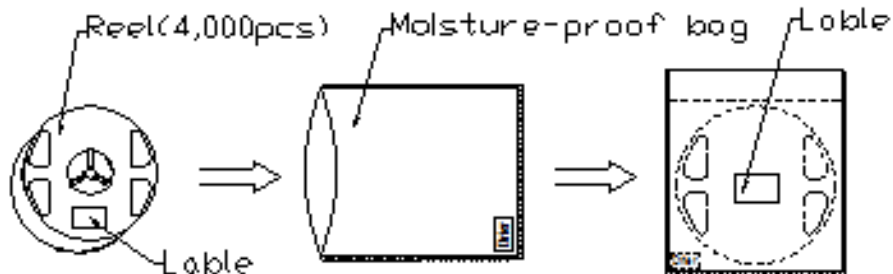

Labeling

Part No: _____

Customer P/N: _____

Item: _____

Q'ty: _____

Vf: _____

Iv: _____

WI: _____

Date: _____

Made in China**Ordering Information**

Part #	Orderable Part #	Spec Range	Quantity per reel
QBLP612-R	QBLP612-R	Iv=70mcd typ. @ I _F =20mA, λ _D : 625nm ~ 635nm	4,000 units
QBLP612-AG	QBLP612-AG	Iv=40mcd typ. @ I _F =20mA, λ _D : 565nm ~ 576nm	4,000 units
QBLP612-IG	QBLP612-IG	Iv=430mcd typ. @ I _F =20mA, λ _D : 520nm ~ 530nm	4,000 units
QBLP612-IW-CW	QBLP612-IW-CW	Iv=320mcd typ. @ I _F =20mA, Chromaticity Coordinate: (X=0.25, Y=0.24) min.	4,000 units

Revision History

Description:	Revision #	Revision Date
New Release of QBLP612 Series	V1.0	09/16/2014
Add yellow color	V1.1	11/27/2017

Disclaimer

QT-BRIGHTTEK reserves the right to make changes without further notice to any products herein to improve reliability, function or design. QT-BRIGHTTEK does not assume any liability arising out of the application or use of any product or circuit described herein; neither does it convey any license under its patent rights, nor the rights of others.

Life Support Policy

QT-BRIGHTTEK's products are not authorized for use as critical components in life support devices or systems without the express written approval of QT-BRIGHTTEK. As used herein:

1. Life support devices or systems are devices or systems which, (a) are intended for surgical implant into the body, or (b) support or sustain life, and (c) whose failure to perform when properly used in accordance with instructions for use provided in the labeling, can be reasonably expected to result in a significant injury of the user.
2. A critical component in any component of a life support device or system whose failure to perform can be reasonably expected to cause the failure of the life support device or system, or to affect its safety or effectiveness.