

6X6X4 PREMIUM SERIES



Features and Benefits

- Quality material – bases, opaque covers and clear covers are all made of high-impact, UV resistant polycarbonate.
- Flexible interior mounting – features the unique and patented Integra adjustable depth “T-Rail” back panel mounting system (back panel and adjustable brackets sold separately).
- Wide range of sizes, configurations and accessories provides capabilities for every application.
- Features multiple bosses for easy installation of devices and DIN rails.
- Standard color – light gray with a gloss finish.
- UL-50 / c-UL Listed (files # E229365, # E207562)



Mounting Feet



Mounting Flanges



Mechanical and Thermal	Test Spec.	Unit	Premium Line
Instrumented Dart Impact @ 73° F		in-lbs.	565
Falling Ball Impact @ 73° F	UL-746	in-lbs.	900
Deflection Temperature @ 264 psi	ASTM D648	Deg. F	270
Modulus of Elasticity	ASTM D790	ksi	340
Temperature Range		Deg. F	-40 to 265
Flammable / UV Ratings	Test Spec.	Unit	Premium Line
Flame Rating - UL	UL 94	-	5VA
Outdoor UV Exposure	UL	-	F1

Part Number	4X IP66	6P IP68	Hinged Cover	Screw Cover	Opaque Cover	Clear Cover	Mounting Feet	Mounting Flange	Stainless Steel Locking Latch	Non-Metallic Locking Latch
H6064S	✓	✓		✓	✓		✓			
H6064SC	✓	✓		✓		✓	✓			
H6064SF	✓	✓		✓	✓			✓		
H6064SCF	✓	✓		✓		✓		✓		
H6064H	✓		✓	✓	✓		✓			
H6064HC	✓		✓	✓		✓	✓			
H6064HF	✓		✓	✓	✓			✓		
H6064HCF	✓		✓	✓		✓		✓		
H6064HLL*	✓		✓		✓		✓		✓	
H6064HCLL*	✓		✓			✓	✓		✓	
H6064HFLL	✓		✓		✓			✓	✓	
H6064HCFLL	✓		✓			✓		✓	✓	
H6064HNL	✓		✓		✓		✓			✓
H6064HCNL	✓		✓			✓	✓			✓
H6064HFNL	✓		✓		✓			✓		✓
H6064HCFNL	✓		✓			✓		✓		✓
H6064H-6P	✓	✓	✓	✓	✓		✓			
H6064HC-6P	✓	✓	✓	✓		✓	✓			
H6064HF-6P	✓	✓	✓	✓	✓			✓		
H6064HCF-6P	✓	✓	✓	✓		✓		✓		

*POPULAR CONFIGURATIONS: Most popular configurations are available for *QuickShip*. Please send requests to customerservice@integraenclosures.com to take advantage of our *QuickShip* option.





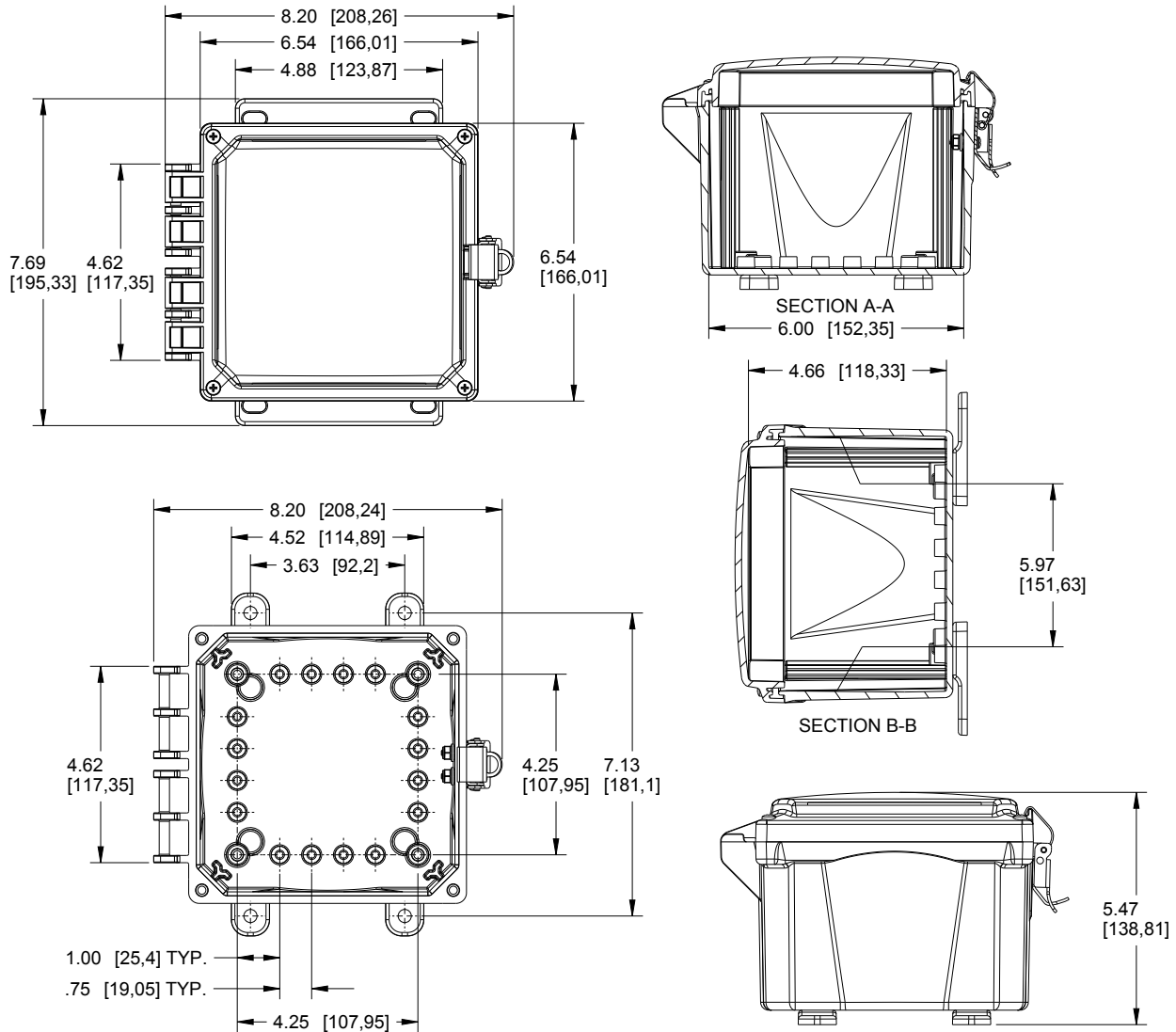



6X6X4 PREMIUM SERIES

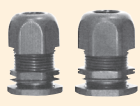

[Bracketed dimensions in mm]. Register online to download this drawing at www.integraenclosures.com

Accessories for 6x6x4 (For complete accessories, see pages 75-79)

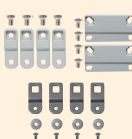
 <p>Back Panels ABP66 - Aluminum panel SBP66 - Steel panel PVCBP66 - PVC panel</p>	 <p>Aluminum Swing Out Panels ABP-66-USOPK - Complete panel kit ABP-66USP - Aluminum swing out panels only USOPK - Hardware only</p>	 <p>Back Panel Adjustment Kit BPAKG - Gray, Set Screw BPAKB - Black, Set Screw UBPAKG - Gray, Thumb Screw UBPAKB - Black Thumb Screw</p>
 <p>Air Vents VENT 3 - Aluminum louvered VENT 2 - Outdoor labyrinth</p>	 <p>Steel Swing Out Panels SBP-66-USOPK - Complete panel kit SBP-66USP - Steel swing out panels only USOPK - Hardware only</p>	 <p>Cord Grips IP68/NEMA 4X/6P rated See page 72 for more details and part numbers.</p>
 <p>Din Rail DIN 6 - 2 rails, 4 screws</p>	 <p>Pole Mounting Kit PMKG-26 - 2" pole PMKG-36 - 3" pole PMKG-46 - 4" pole PMKG-126 - 12" pole</p>	 <p>Mounting Feet & Flange Kits MFKG - Premium line feet MFKSS - Stainless steel feet MFLK6 - 6" Flange kit</p>