



30W Single Port Multi-Gig Power-over-Ethernet Passive Power Injector



Features

- No Detection – passive injector
- Non-Vented Case
- Multi-Gigabit Data Rates (1G, 2.5G, 5G, 10G)
- DoE Level VI Compliant
- ErP/Ecodesign Directive 2009/125/EC – Regulation EU 2019/1782 Compliant
- EU CoC Version 5 Tier 2 Compliant
- Full Protection OCP, OVP
- Limited Power Source (LPS)
- 1-year Warranty

Applications

- IP telephones
- Wireless Network Access Points
- Security Cameras
- Bluetooth® Access Points
- WiMAX® Access Points



POEA30U-560 Specifications¹

Model		POEA30U-560-R ²	POEA30U-560E-R ³	POEA30U-560-2-R ³
Output	DC Output Voltage ⁴	56.0V (+1V, -2V)		
	Max Current	0.536A		
	Output Power	30.02W		
	Data Speed	1G	1G	2.5G
	Regulation	± 5%		
	Ripple & Noise P-P(max) ⁵	200mV		
Input	AC Input Voltage Range	90 to 264VAC		
	AC Input Frequency	47 to 63Hz		
	Input Current	0.8A (RMS) max		
	No Load Power Consumption at 115VAC Input	0.061W		
	No Load Power Consumption at 230VAC Input	0.071W		
	115VAC Average Efficiency ⁶	89.97%		
	230VAC Average Efficiency ⁶	89.90%		
	230VAC 10% Load Efficiency ⁶	81.40%		
	Leakage Current	3.5mA max at 254VAC/50Hz		
Protections	Over-Voltage	<120V		
	Over-Current	≤1200mA max		
	Short Circuit	Non-latching. Auto-recover.		
Environmental	Operating Temperature	-10°C to +50°C		
	Non-Operating Temperature	-20° to +70°C		
	Operating Humidity	5 to 90% RH max		
Safety Approvals and EMC	Dielectric Withstand (HI-POT)	Primary to Secondary: 4242VDC for 1 min, 10mA		
	Insulation Resistance	Primary to Secondary: >10M ohm for 500VDC		
	Standards	cULus 60950-1, cULus 62368-1, IEC 60950-1, IEC 62368-1		
	EMI Emissions	FCC Part 15 Class B, CAN ICES-003(B)/NMB-003(B), EN 55032/CISPR 32 Class B Conducted and Radiated		
	Harmonic Current Emissions	IEC 61000-3-2		
	Voltage Fluctuations & Flicker	IEC 61000-3-3		
	Immunity	EN 55035/CISPR 35: IEC 61000-4-2 (Contact: ±8KV, Air: ±15KV) ⁷ , IEC 61000-4-3, IEC 61000-4-4, IEC 61000-4-5 (± 2kV), IEC 61000-4-6, IEC 61000-4-8, IEC 61000-4-11		
Mechanical	Dimensions (L x W x H)	132.5mm (5.22in) x 45.5mm (1.79in) x 30.0mm (1.18in)		
	Weight	200g		
	Input Connector	IEC320 C14		
	Output Connection	+pins 3,6/ -pins 1,2		
	Data In/Output Connector	Unshielded RJ45	Shielded RJ45	Shielded RJ45
	LED Indicators	Solid Blue: Power "ON"		

Model		POEA30U-560-5-R ³	POEA30U-560-X-R ³
Output	DC Output Voltage ⁴	56.0V (+1V, -2V)	
	Max Current	0.536A	
	Output Power	30.02W	
	Data Speed	5G	10G
	Regulation	± 5%	
	Ripple & Noise P-P(max) ⁵	200mV	
Input	AC Input Voltage Range	90 to 264VAC	
	AC Input Frequency	47 to 63Hz	
	Input Current	0.8A (RMS) max	
	No Load Power Consumption at 115VAC Input	0.061W	
	No Load Power Consumption at 230VAC Input	0.071W	
	115VAC Average Efficiency ⁶	89.97%	
	230VAC Average Efficiency ⁶	89.90%	
	230VAC 10% Load Efficiency ⁶	81.40%	
Protections	Leakage Current	3.5mA max at 254VAC/50Hz	
	Over-Voltage	<120V	
	Over-Current	≤1200mA max	
Environmental	Short Circuit	Non-latching. Auto-recover.	
	Operating Temperature	-10°C to +50°C	
	Non-Operating Temperature	-20° to +70°C	
Safety Approvals and EMC	Operating Humidity	5 to 90% RH max	
	Dielectric Withstand (HI-POT)	Primary to Secondary: 4242VDC for 1 min, 10mA	
	Insulation Resistance	Primary to Secondary: >10M ohm for 500VDC	
	Standards	cULus 60950-1, cULus 62368-1, IEC 60950-1, IEC 62368-1	
	EMI Emissions	FCC Part 15 Class B, CAN ICES-003(B)/NMB-003(B), EN 55032/CISPR 32 Class B Conducted and Radiated	
	Harmonic Current Emissions	IEC 61000-3-2	
	Voltage Fluctuations & Flicker	IEC 61000-3-3	
Mechanical	Immunity	EN 55035/CISPR 35: IEC 61000-4-2 (Contact: ±8KV, Air: ±15KV) ⁷ , IEC 61000-4-3, IEC 61000-4-4, IEC 61000-4-5 (± 2kV), IEC 61000-4-6, IEC 61000-4-8, IEC 61000-4-11	
	Dimensions (L x W x H)	132.5.mm (5.22in) x 45.5mm (1.79in) x 30.0mm (1.18in)	
	Weight	200g	
	Input Connector	IEC320 C14	
	Output Connection	+pins 3,6/ -pins 1,2	
	Data In/Output Connector	Shielded RJ45	Shielded RJ45
Notes	LED Indicators	Solid Blue: Power "ON"	
		<ol style="list-style-type: none"> The specifications defined are at ambient temperature of 25°C, unless otherwise specified. Not recommended for new designs (NRND). Minimum order quantities apply. Built-to-Order. Minimum order quantities apply. Voltage to be measured within 5cm of RJ45 output connector 20MHz bandwidth frequency oscilloscope, add a 0.1µF multilayer Cap. and Low ESR Electrolytic Cap. (10µF) at output connector terminals (nominal line voltage, full load). Efficiency is measured after 30 minutes burn-in. Applies to builds after 05/2021. Original spec is 6KV Contact/8KV Air. 	



POEA30U-560 Outline Drawing

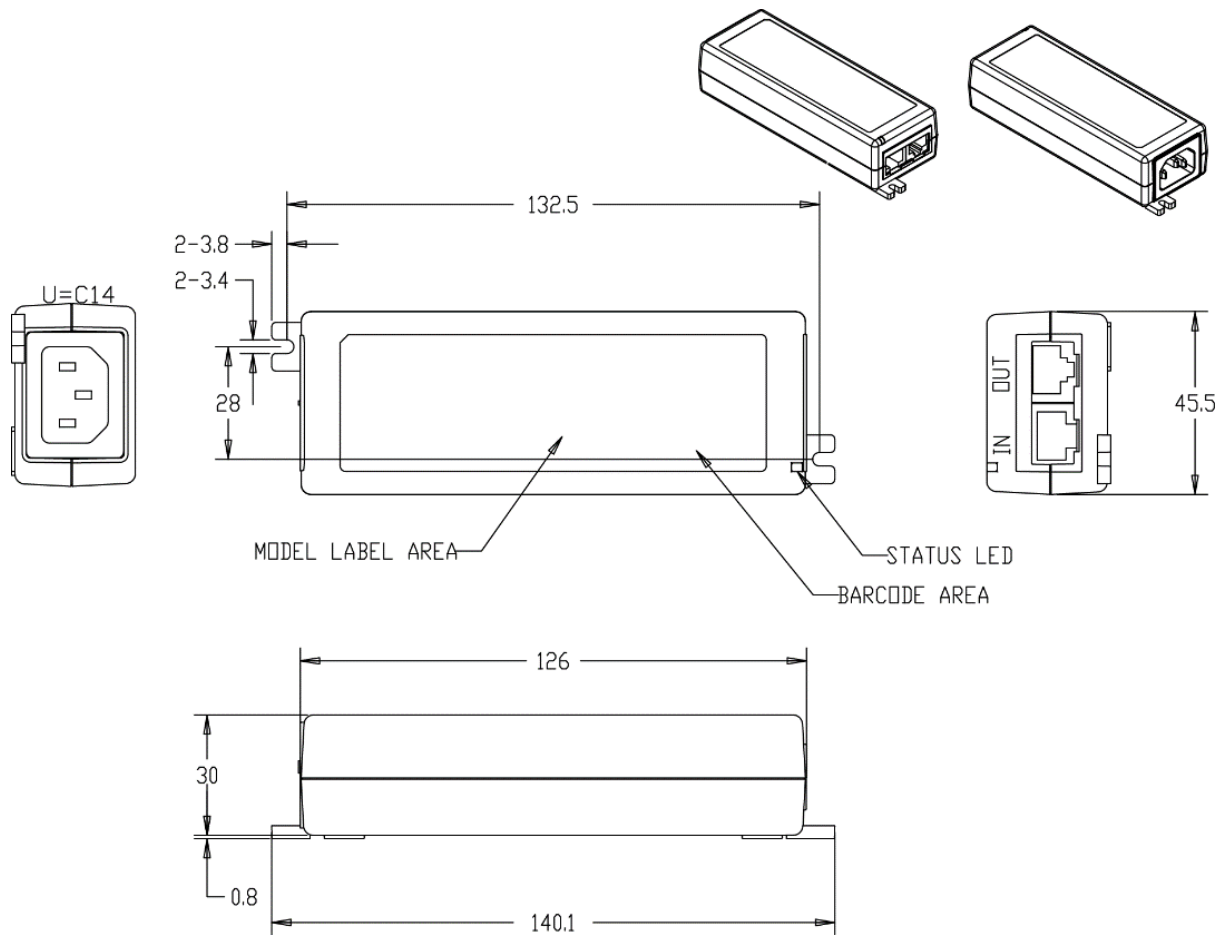





Supplier's Declaration of Conformity
47 CFR § 2.1077 Compliance Information

Phihong USA Corporation
47800 Fremont Boulevard
Fremont, CA 94538
Telephone: (510) 445-0100
www.phihong.com

This device complies with/The devices in this product series comply with part 15 of the FCC Rules. Operation is subject to the following two conditions: (1) This device may not cause harmful interference, and (2) this device must accept any interference received, including interference that may cause undesired operation.



C14 Line Cords - Sold Separately

Model		AC30UNA-R	AC30UEU-R	AC30UUK-R
Specifications	Plug Type	North America NEMA 5-15P	Continental Europe CEE 7VIII	United Kingdom BS 1363
	Connector	IEC320 C13	IEC320 C13	IEC320 C13
	Wire Size	18 AWG	0.75mm	1.0mm
	Temperature	60°C	70°C	70 °C
	Amperage Rating	10A	6A	10A
	Voltage Rating	125V	250V	250V
	Cable Length	1830mm	1830mm	2500mm
Safety Approvals		CSA; UL	CEBEC; DEMKO; DVE; FIMKO; GOST; IMQ; KEMA; NEMKO; NF; OVE; SEMKO	BSI; Safety Mark
Photos				



C14 Line Cords Outline Drawings

AC30UNA-R

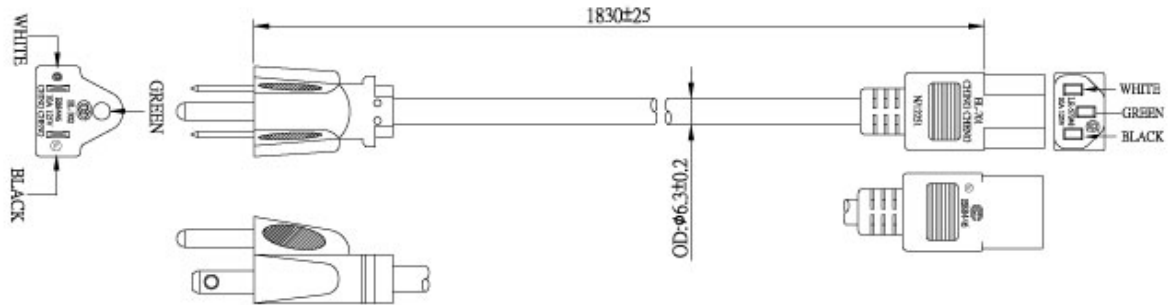

AC30UEU-R

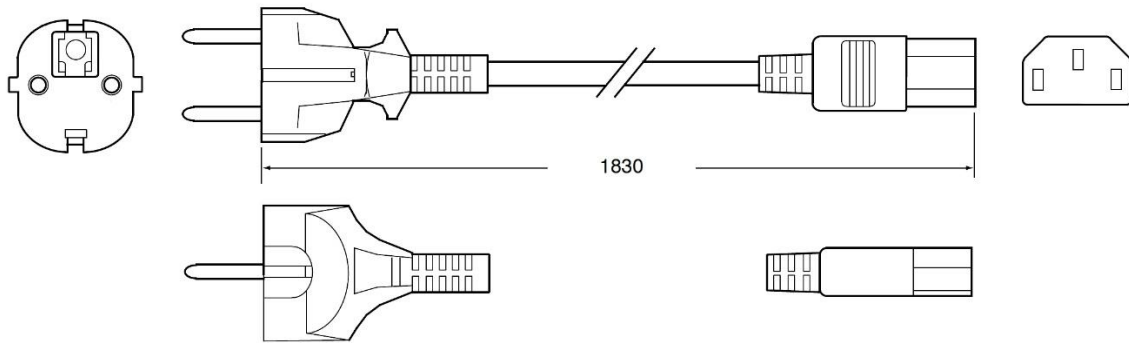

AC30UUK-R

