



PJD60R540E / PJP60R540E / PJF60R540E

600V N-Channel Super Junction MOSFET

Voltage

600 V

Current

9 A

Features

- $R_{DS(ON)}$, $V_{GS}@10V$, $I_D@2.8A < 0.535\Omega$
- Fast switching speed
- Low on-resistance
- Low Noise
- Lead free in compliance with EU RoHS 2.0
- Green molding compound as per IEC 61249 standard

Mechanical Data

- Case : TO-252AA, TO-220AB, ITO-220AB-F
- Terminals : Solderable per MIL-STD-750, Method 2026
- TO-252AA Approx. Weight : 0.0104 ounces, 0.297grams
- TO-220AB Approx. Weight : 0.067 ounces, 1.89 grams
- ITO-220AB-F Approx. Weight : 0.068 ounces, 2 grams

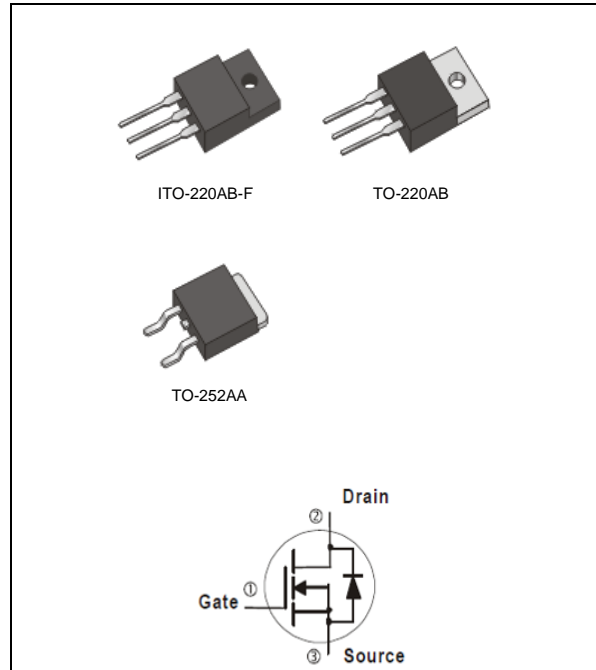

Maximum Ratings and Thermal Characteristics ($T_A=25^\circ\text{C}$ unless otherwise noted)

PARAMETER		SYMBOL	TO-220AB	ITO-220AB-F	TO-252AA	UNITS
Drain-Source Voltage		V_{DS}	600			V
Gate-Source Voltage		V_{GS}	±20			
Continuous Drain Current (Note 4)	$T_C=25^\circ\text{C}$	I_D	9			A
	$T_C=100^\circ\text{C}$		5			
Pulsed Drain Current (Note 1)		I_{DM}	18			
Power Dissipation (Note 3)	$T_C=25^\circ\text{C}$	P_D	94	48	94	W
	$T_C=100^\circ\text{C}$		38	19	38	
Continuous Drain Current (Note 4)	$T_A=25^\circ\text{C}$	I_D	1.3			A
	$T_A=70^\circ\text{C}$		1			
Power Dissipation	$T_A=25^\circ\text{C}$	P_D	2	1.04	2	W
	$T_A=70^\circ\text{C}$		1.3	0.9	1.3	
Single Pulse Avalanche Energy (Note 6)		E_{AS}	98			mJ
Operating Junction and Storage Temperature Range		T_J, T_{STG}	-55~150			$^\circ\text{C}$
Typical Thermal Resistance (Note 4,5)		$R_{\theta JC}$	1.33	2.6	1.33	$^\circ\text{C/W}$
		$R_{\theta JA}$	62.5	120	62.5	

- Limited only By Maximum Junction Temperature



PJD60R540E / PJP60R540E / PJF60R540E

Electrical Characteristics ($T_A=25^\circ\text{C}$ unless otherwise noted)

PARAMETER	SYMBOL	TEST CONDITION	MIN.	TYP.	MAX.	UNITS
Static						
Drain-Source Breakdown Voltage	BV_{DSS}	$V_{GS}=0V, I_D=250\mu A$	600	-	-	V
Gate Threshold Voltage	$V_{GS(th)}$	$V_{DS}=V_{GS}, I_D=250\mu A$	2	2.98	4	
Drain-Source On-State Resistance	$R_{DS(on)}$	$V_{GS}=10V, I_D=2.8A$	-	0.45	0.535	Ω
Zero Gate Voltage Drain Current	I_{DSS}	$V_{DS}=600V, V_{GS}=0V$	-	-	1	μA
Gate-Source Leakage Current	I_{GSS}	$V_{GS}=\pm 20V, V_{DS}=0V$	-	-	± 100	nA
Diode Forward Voltage	V_{SD}	$I_S=9A, V_{GS}=0V$	-	0.98	1.5	V
Transconductance	G_{FS}	$V_{DS}=10V, I_D=4.5A$	-	4.5	-	S
Dynamic <small>(Note 7)</small>						
Total Gate Charge	Q_g	$V_{DS}=300V, I_D=9A,$ $V_{GS}=10V$ <small>(Note 2,3)</small>	-	23.7	-	nC
Gate-Source Charge	Q_{gs}		-	3.5	-	
Gate-Drain Charge	Q_{gd}		-	13.3	-	
Gate Input Resistance	R_g	$F = 1\text{MHz}$	-	10.1	-	Ω
Input Capacitance	C_{iss}	$V_{DS}=25V, V_{GS}=0V,$ $f=1\text{MHz}$	-	531	-	pF
Output Capacitance	C_{oss}		-	547	-	
Reverse Transfer Capacitance	C_{rss}		-	69	-	
Turn-On Delay Time	$t_{d(on)}$	$V_{DD}=300V, I_D=4.5A,$ $R_G=10\Omega$ <small>(Note 2,3)</small>	-	11	-	ns
Turn-On Rise Time	t_r		-	26	-	
Turn-Off Delay Time	$t_{d(off)}$		-	69	-	
Turn-Off Fall Time	t_f		-	26	-	
Drain-Source Diode						
Maximum Continuous Drain-Source Diode Forward Current	I_S	---	-	-	9	A
Maximum Pulsed Drain-Source Diode Forward Current	I_{SM}	---	-	-	18	
Reverse Recovery Time	t_{rr}	$V_{GS}=0V, I_S=9A$	-	354	-	ns
Reverse Recovery Charge	Q_{rr}	$di_f/dt=100A/\mu s$ <small>(Note 2)</small>	-	4.3	-	μC

NOTES :

1. Pulse width $\leq 300\mu s$, Duty cycle $\leq 2\%$.
2. Essentially independent of operating temperature typical characteristics.
3. Repetitive rating, pulse width limited by junction temperature $T_{J(MAX)}=150^\circ\text{C}$. Ratings are based on low frequency and duty cycles to keep initial $T_J=25^\circ\text{C}$.
4. The maximum current rating is package limited.
5. TO-252AA mounted on a 1 inch² with 2oz. square pad of copper.
6. $L=100\text{mH}$, $I_{AS}=1.4A$, $V_{DD}=50V$, $R_G=25\text{ohm}$, Starting $T_J=25^\circ\text{C}$.
7. Guaranteed by design, not subject to production testing.



PJD60R540E / PJP60R540E / PJF60R540E

TYPICAL CHARACTERISTIC CURVES

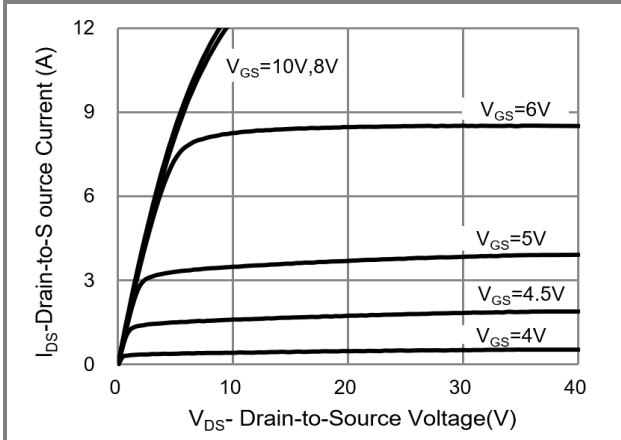

Fig.1 Output Characteristics

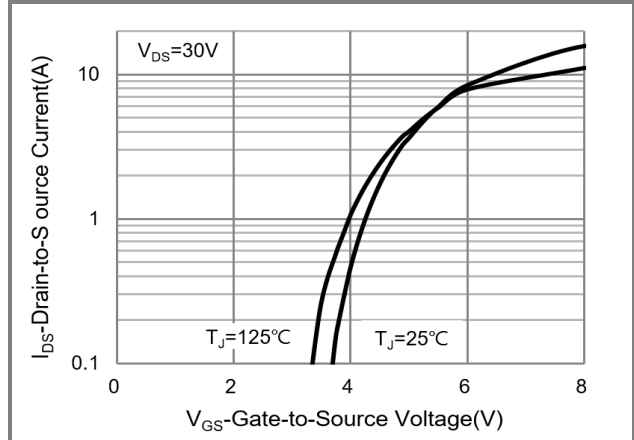

Fig.2 Transfer Characteristics

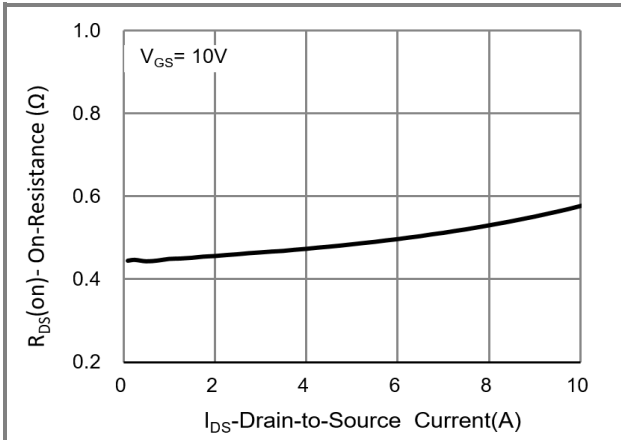

Fig.3 On-Resistance vs. Drain Current

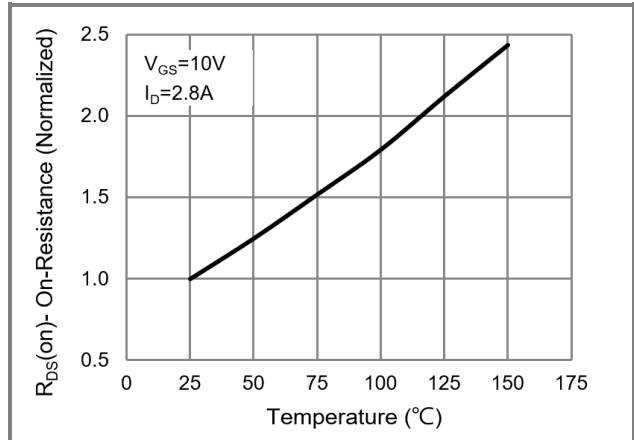

Fig.4 On-Resistance vs. Junction Temperature

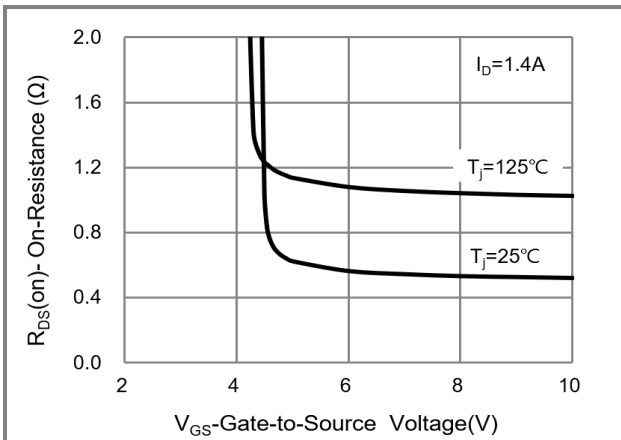

Fig.5 On-Resistance Variation with V_{GS}

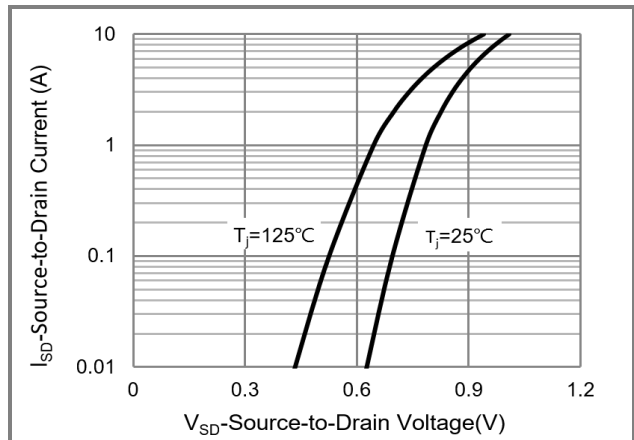

Fig.6 Source-Drain Diode Forward Voltage



PJD60R540E / PJP60R540E / PJF60R540E

TYPICAL CHARACTERISTIC CURVES

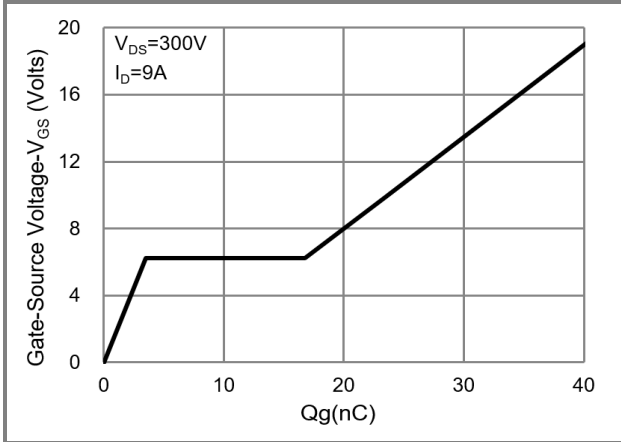

Fig.7 Gate-Charge Characteristics

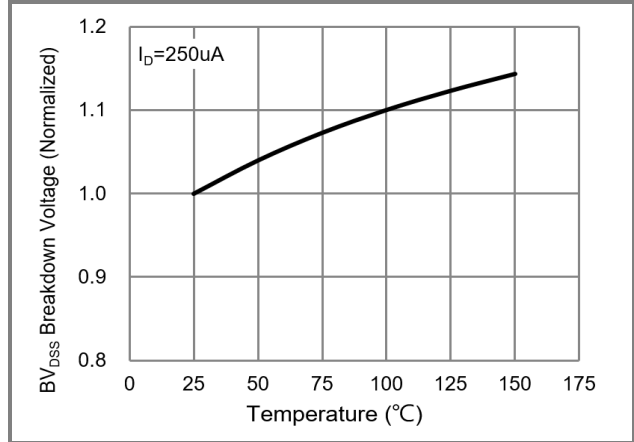

Fig.8 Breakdown Voltage Variation vs. Temperature

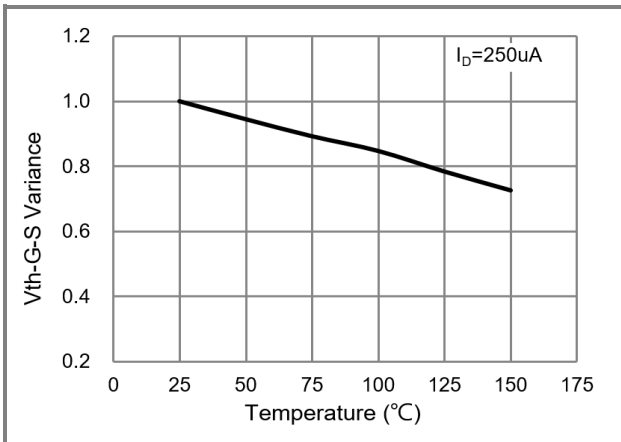

Fig.9 Threshold Voltage Variation with Temperature

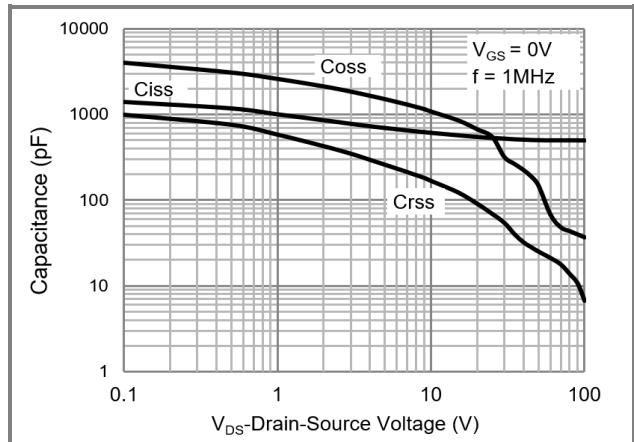

Fig.10 Capacitance vs. Drain-Source Voltage

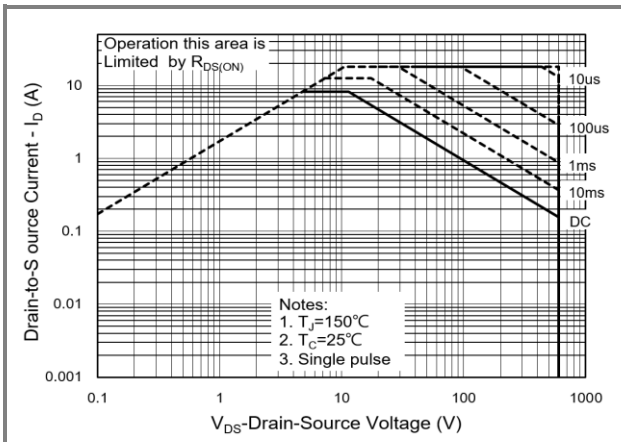

Fig.11 PJD Maximum Safe Operating Area

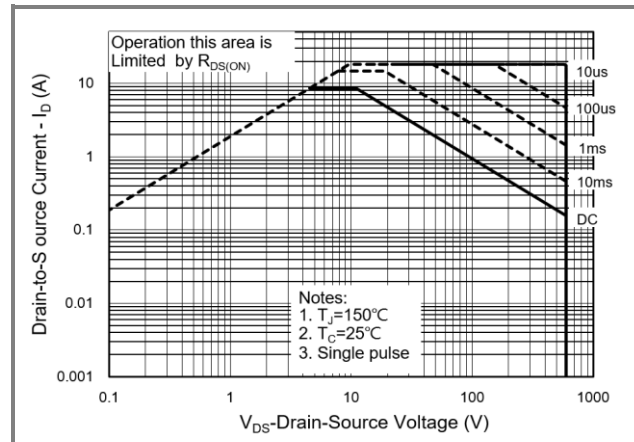

Fig.12 PJP Maximum Safe Operating Area



PJD60R540E / PJP60R540E / PJF60R540E

TYPICAL CHARACTERISTIC CURVES

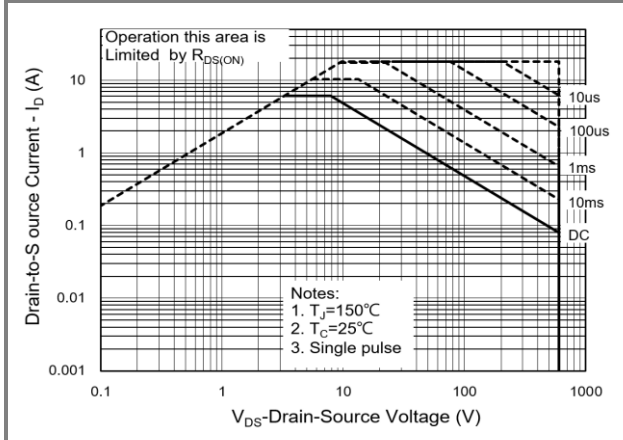

Fig.13 PJD Maximum Safe Operating Area

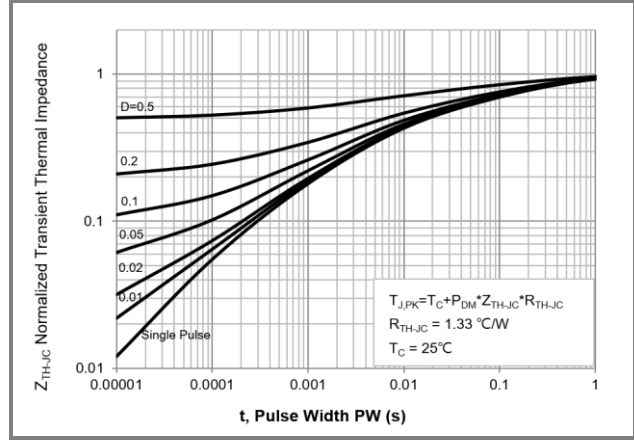

Fig.14 PJD Normalized Transient Thermal Impedance

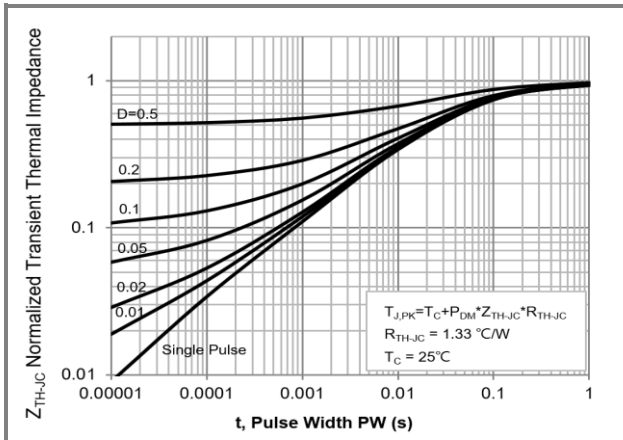

Fig.15 PJP Normalized Transient Thermal Impedance

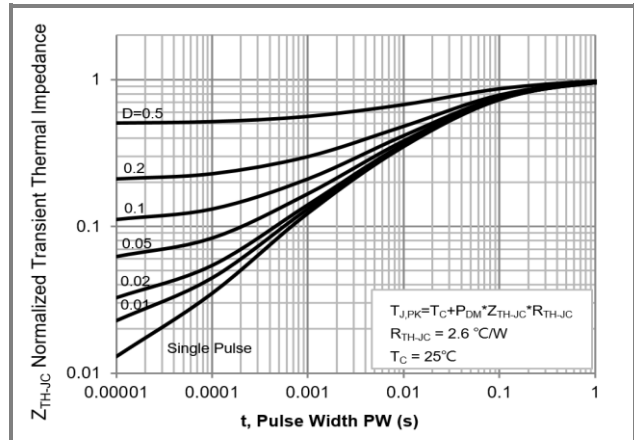

Fig.16 PJF Normalized Transient Thermal Impedance

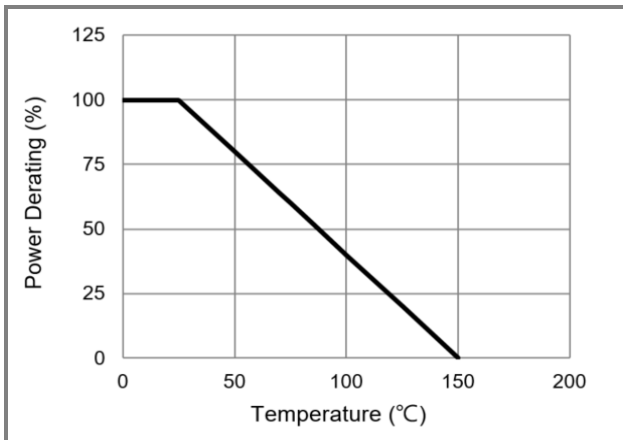
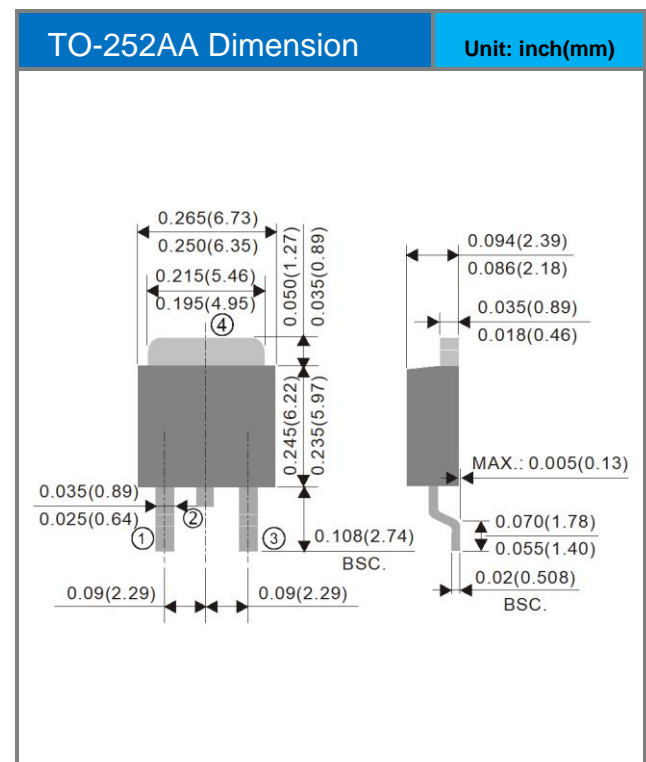
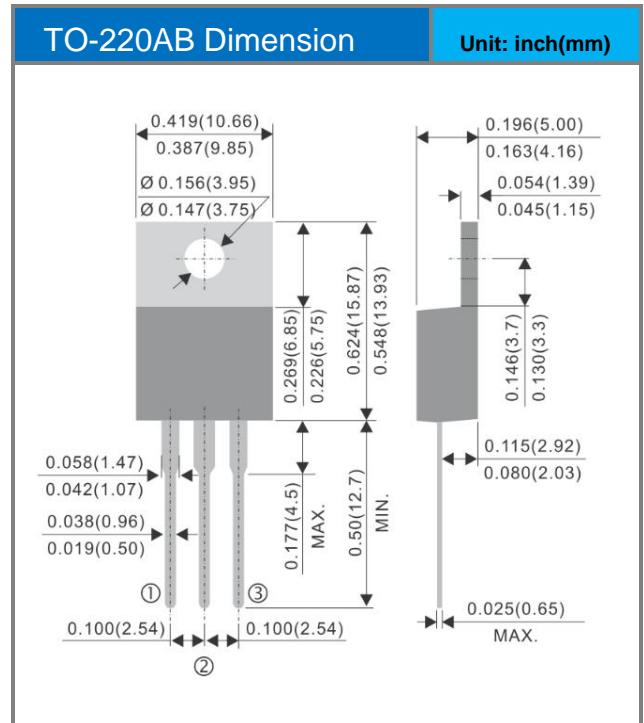
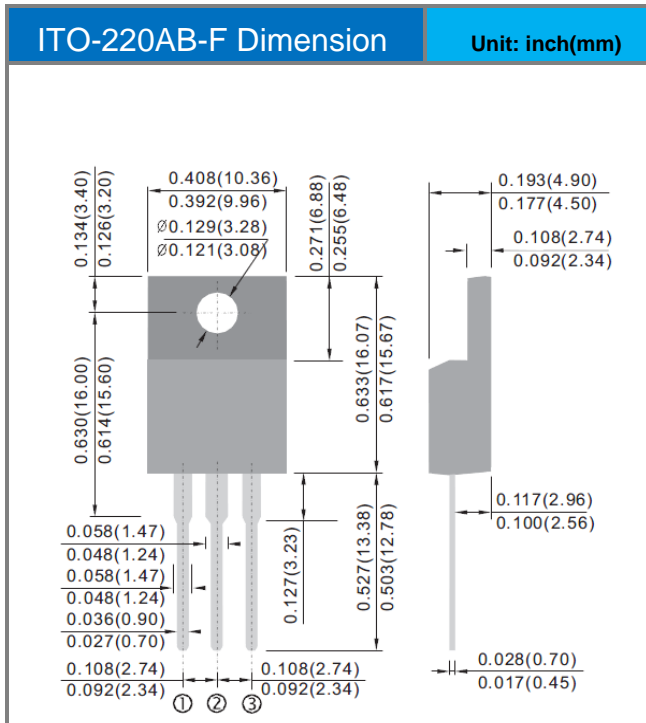

Fig.17 Total Power Dissipation



PJD60R540E / PJP60R540E / PJF60R540E

Packaging Information





PJD60R540E / PJP60R540E / PJF60R540E

Part No Packing Code Version

Part No Packing Code	Package Type	Packing Type	Marking	Version
PJD60R540E_L2_00001	TO-252AA	3,000pcs / 13" reel	60R540E	Halogen free
PJP60R540E_T0_00001	TO-220AB	50pcs / Tube	60R540E	Halogen free
PJF60R540E_T0_00001	ITO-220AB-F	50pcs / Tube	60R540E	Halogen free



PJD60R540E / PJP60R540E / PJF60R540E

Disclaimer

- Reproducing and modifying information of the document is prohibited without permission from Panjit International Inc..
- Panjit International Inc. reserves the rights to make changes of the content herein the document anytime without notification. Please refer to our website for the latest document.
- Panjit International Inc. disclaims any and all liability arising out of the application or use of any product including damages incidentally and consequentially occurred.
- Panjit International Inc. does not assume any and all implied warranties, including warranties of fitness for particular purpose, non-infringement and merchantability.
- Applications shown on the herein document are examples of standard use and operation. Customers are responsible in comprehending the suitable use in particular applications. Panjit International Inc. makes no representation or warranty that such applications will be suitable for the specified use without further testing or modification.
- The products shown herein are not designed and authorized for equipments requiring high level of reliability or relating to human life and for any applications concerning life-saving or life-sustaining, such as medical instruments, transportation equipment, aerospace machinery et cetera. Customers using or selling these products for use in such applications do so at their own risk and agree to fully indemnify Panjit International Inc. for any damages resulting from such improper use or sale.
- Since Panjit uses lot number as the tracking base, please provide the lot number for tracking when complaining.