



PJA3431

20V P-Channel Enhancement Mode MOSFET – ESD Protected

Voltage **-20 V** **Current** **-1.5A**

Features

- $R_{DS(ON)}$, $V_{GS}@-4.5V$, $I_D@-1.5A < 325m\Omega$
- $R_{DS(ON)}$, $V_{GS}@-2.5V$, $I_D@-1.2A < 420m\Omega$
- $R_{DS(ON)}$, $V_{GS}@-1.8V$, $I_D@-0.5A < 600m\Omega$
- Advanced Trench Process Technology
- Specially Designed for Switch Load, PWM Application, etc.
- ESD Protected 2KV HBM
- Lead free in comply with EU RoHS 2011/65/EU directives.
- Green molding compound as per IEC61249 Std.
(Halogen Free)

Mechanical Data

- Case : SOT-23 Package
- Terminals : Solderable per MIL-STD-750, Method 2026
- Approx. Weight : 0.0003 ounces, 0.0084 grams
- Marking : A31

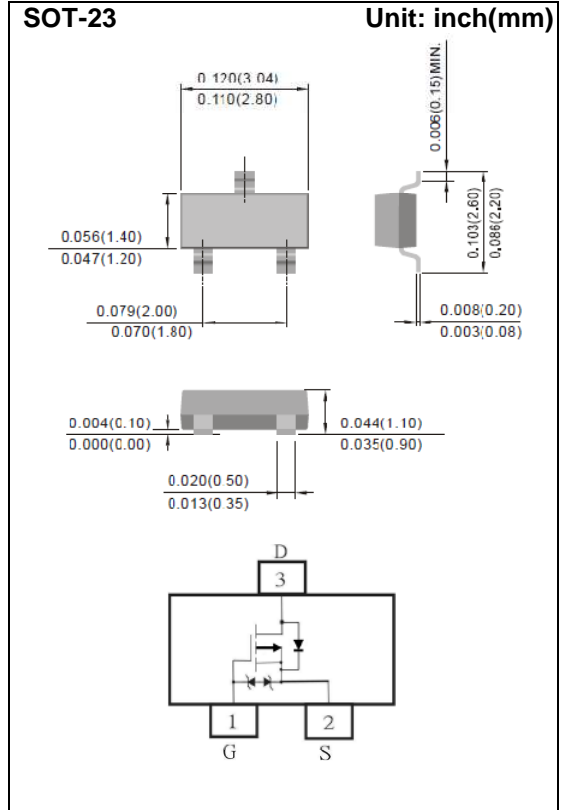

Maximum Ratings and Thermal Characteristics ($T_A=25^\circ C$ unless otherwise noted)

PARAMETER	SYMBOL	LIMIT	UNITS
Drain-Source Voltage	V_{DS}	-20	V
Gate-Source Voltage	V_{GS}	± 8	V
Continuous Drain Current	I_D	-1.5	A
Pulsed Drain Current (Note 4)	I_{DM}	-4	A
Power Dissipation	P_D	$T_a=25^\circ C$	1.25
		Derate above $25^\circ C$	10
Operating Junction and Storage Temperature Range	T_J, T_{STG}	-55~150	$^\circ C$
Typical Thermal resistance	$R_{\theta JA}$	100	$^\circ C/W$
- Junction to Ambient (Note 3)			



PJA3431

Electrical Characteristics (T_A=25°C unless otherwise noted)

PARAMETER	SYMBOL	TEST CONDITION	MIN.	TYP.	MAX.	UNITS
Static						
Drain-Source Breakdown Voltage	BV _{DSS}	V _{GS} =0V, I _D =-250uA	-20	-	-	V
Gate Threshold Voltage	V _{GS(th)}	V _{DS} =V _{GS} , I _D =-250uA	-0.5	-0.64	-1.0	V
Drain-Source On-State Resistance	R _{DS(on)}	V _{GS} =-4.5V, I _D =-1.5A	-	240	325	mΩ
		V _{GS} =-2.5V, I _D =-1.2A	-	295	420	
		V _{GS} =-1.8V, I _D =-0.5A	-	405	600	
Zero Gate Voltage Drain Current	I _{DSS}	V _{DS} =-20V, V _{GS} =0V	-	-0.02	-1	uA
Gate-Source Leakage Current	I _{GSS}	V _{GS} =±8V, V _{DS} =0V	-	±3.5	±10	uA
Dynamic						
Total Gate Charge	Q _g	V _{DS} =-10V, I _D =-1.5A, V _{GS} =-4.5V (Note 1,2)	-	1.7	-	nC
Gate-Source Charge	Q _{gs}		-	0.35	-	
Gate-Drain Charge	Q _{gd}		-	0.43	-	
Input Capacitance	C _{iss}	V _{DS} =-10V, V _{GS} =0V, f=1.0MHZ	-	165	-	pF
Output Capacitance	C _{oss}		-	25	-	
Reverse Transfer Capacitance	C _{rss}		-	14.7	-	
Switching						
Turn-On Delay Time	td _(on)	V _{DD} =-10V, I _D =-1.5A, V _{GS} =-4.5V, R _G =6Ω (Note 1,2)	-	11	-	ns
Turn-On Rise Time	tr		-	38	-	
Turn-Off Delay Time	td _(off)		-	130	-	
Turn-Off Fall Time	tf		-	75	-	
Drain-Source Diode						
Maximum Continuous Drain-Source Diode Forward Current	I _s	---	-	-	-1.6	A
Diode Forward Voltage	V _{sD}	I _s =-1.6A, V _{GS} =0V	-	-1.03	-1.2	V

NOTES :

1. Pulse width ≤ 300us, Duty cycle ≤ 2%
2. Essentially independent of operating temperature typical characteristics.
3. R_{θJA} is the sum of the junction-to-case and case-to-ambient thermal resistance where the case thermal reference is defined as the solder mounting surface of the drain pins. Mounted on a 1 inch FR-4 with 2oz.square pad of copper.
4. The maximum current rating is package limited.



PJA3431

TYPICAL CHARACTERISTIC CURVES

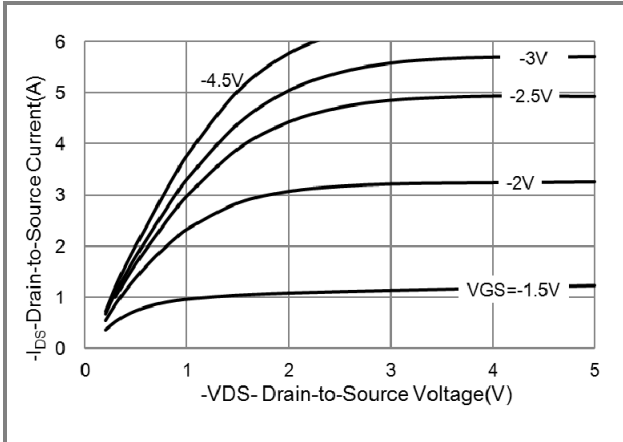

Fig.1 On-Region Characteristics

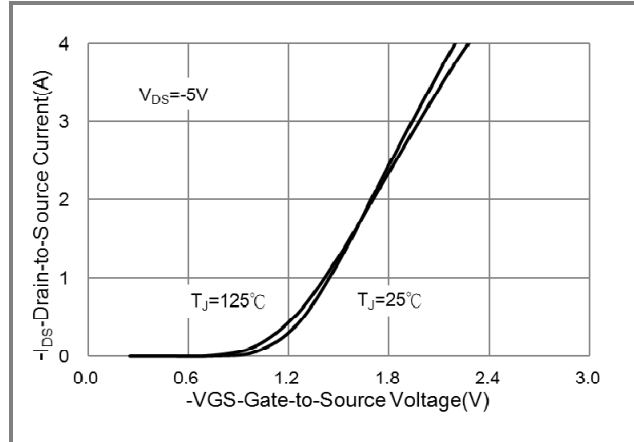

Fig.2 Transfer Characteristics

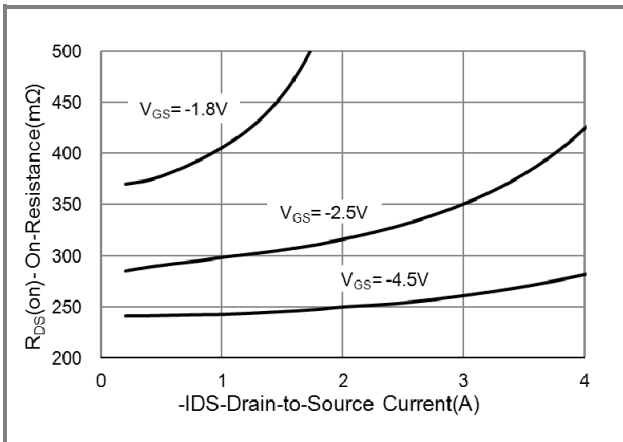

Fig.3 On-Resistance vs. Drain Current

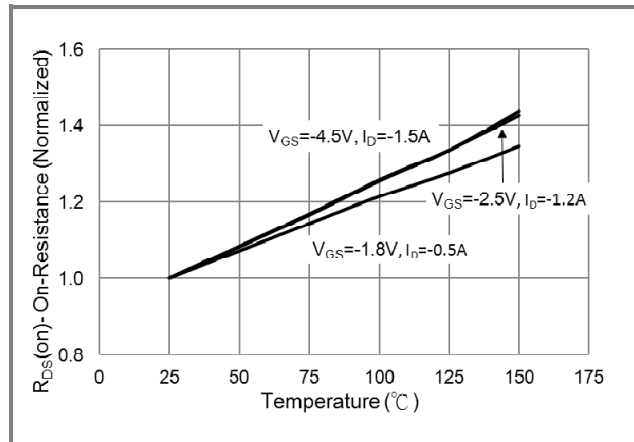

Fig.4 On-Resistance vs. Junction temperature

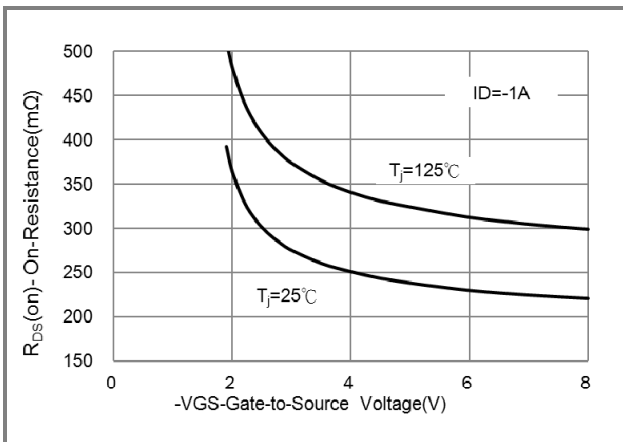

Fig.5 On-Resistance Variation with VGS

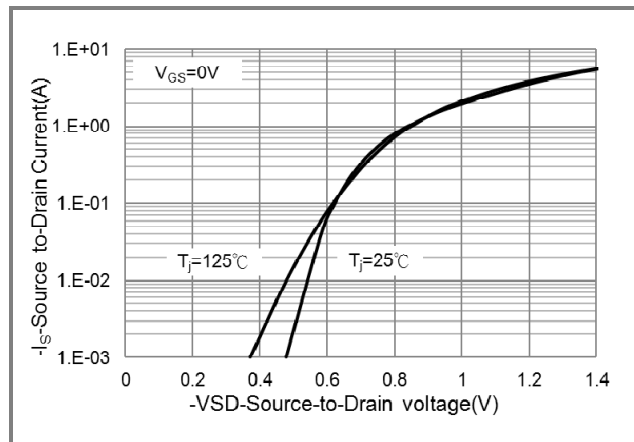

Fig.6 Body Diode Characteristics



PJA3431

TYPICAL CHARACTERISTIC CURVES

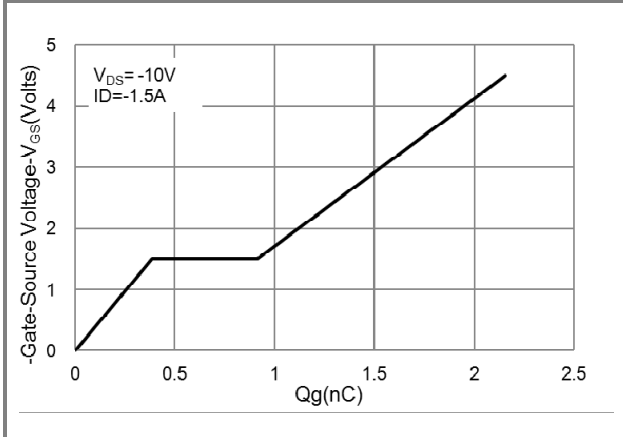

Fig.7 Gate-Charge Characteristics

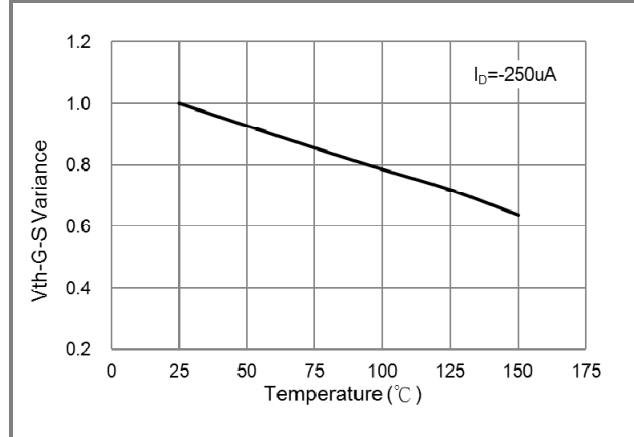

Fig.8 Threshold Voltage Variation with Temperature

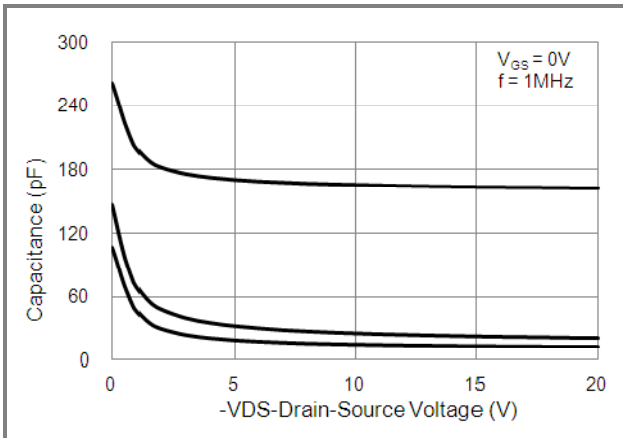

Fig.9 Capacitance vs. Drain-Source Voltage



PJA3431

Part No. Packing Code Version

Part No. Packing Code	Package Type	Packing Type	Marking	Version
PJA3431_R1_00001	SOT-23	3K pcs / 7" reel	A31	Halogen free
PJA3431_R2_00001	SOT-23	12K pcs / 1" reel	A31	Halogen free

Mounting Pad Layout

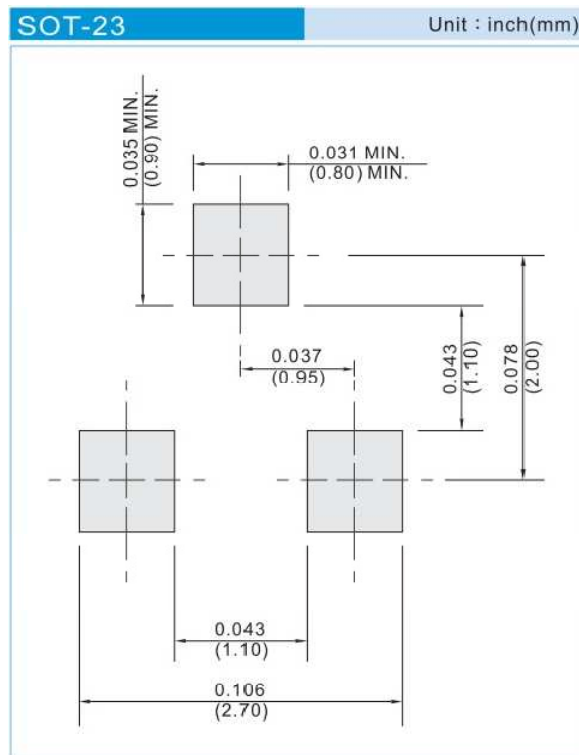



PJA3431

Disclaimer

- Reproducing and modifying information of the document is prohibited without permission from Panjit International Inc..
- Panjit International Inc. reserves the rights to make changes of the content herein the document anytime without notification. Please refer to our website for the latest document.
- Panjit International Inc. disclaims any and all liability arising out of the application or use of any product including damages incidentally and consequentially occurred.
- Panjit International Inc. does not assume any and all implied warranties, including warranties of fitness for particular purpose, non-infringement and merchantability.
- Applications shown on the herein document are examples of standard use and operation. Customers are responsible in comprehending the suitable use in particular applications. Panjit International Inc. makes no representation or warranty that such applications will be suitable for the specified use without further testing or modification.
- The products shown herein are not designed and authorized for equipments requiring high level of reliability or relating to human life and for any applications concerning life-saving or life-sustaining, such as medical instruments, transportation equipment, aerospace machinery et cetera. Customers using or selling these products for use in such applications do so at their own risk and agree to fully indemnify Panjit International Inc. for any damages resulting from such improper use or sale.
- Since Panjit uses lot number as the tracking base, please provide the lot number for tracking when complaining.