

# PS2P-CON

## Touchless Concentric Rotary Hall-Effect Position Sensor

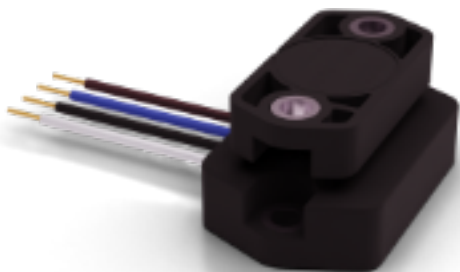

Available with  
**CAN**

### KEY FEATURES

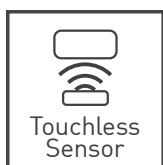

#### True touchless operation

Without any internal or external gears or linkages the sensor is easily assembled and calibrated and free from wear and tear over lifetime.



#### Unlimited mechanical life

The separation of electronics and magnet module allows for a virtually unlimited lifetime independent of number of revolutions.



#### Made for harsh environments

IP69K sealing, high operating temperature range as well as shock and vibration resistance allow the use in the most demanding environments.

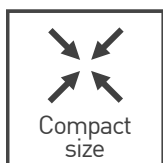

#### Compact and low profile package

Without the need for a shaft the sensor is provided in an exceptionally compact and low profile package that fits in space constraint applications.



#### Adaptable to your requirements

Custom mechanical design, programmable transfer function and switch outputs as well as different output protocols and redundancy levels available.

### DESCRIPTION

Piher Sensing Systems' PS2P-CON rotary position sensor delivers true touchless sensing for harsh industrial and vehicle environments in a low profile and robust magnetic design.

Magnet and sensor module are placed in separate housings without the need for any gears, bearings or linkages and can be placed anywhere on the pivoting shaft. This allows for easy mounting, thereby delivering additional cost reduction on the production line. Furthermore, without wear and tear of radial forces product reliability and lifetime are increased significantly.

The PS2P-CON measures changes in angular position relative to the sensor by detecting the movement of a diametrically magnetized magnet that is located in a separate housing and is only sensitive to the flux density co-planar with the IC surface.

The PS2P series is complemented by touchless linear (PS2P-LIN) and variable air gap arc (PS2P-ARC) position sensors. All sensors of the series are absolute sensors and will deliver the same level of precision and stability throughout their lifetime as on the first day they are installed - despite extremes of vibration, shock, temperature and contamination.

### APPLICATIONS

#### Off-Highway

- ▶ Bucket position
- ▶ Pedal / throttle position
- ▶ Hitch position
- ▶ Bus suspension / kneeling position
- ▶ Transmission systems

#### Automotive

- ▶ Gear selector
- ▶ Transmission systems

#### Home & Building Automation

- ▶ HVAC damper actuator monitoring

#### Marine

- ▶ Trim / tilt position

#### Industrial

- ▶ Robotic / hydraulic arm position
- ▶ Valve monitoring
- ▶ IoT modules
- ▶ Vacuum circuit breaker monitoring

# PS2P-CON

## Touchless Concentric Rotary Hall-Effect Position Sensor

### MECHANICAL SPECIFICATIONS

	With magnet M001	With magnet M006
Life	Virtually unlimited	
Nominal air gap	3mm, between plastic parts	1mm, between plastic parts
Maximum air gap	5mm, higher on request	1.5mm, higher on request
Maximum allowed radial offset	±3mm	Contact Piher Sensing Systems

### ELECTRICAL SPECIFICATIONS

Linearity <sup>1</sup>	±1% absolute (±0.5% upon request)	
Angular range	Programmable from 15 to 360 degrees	
Output protocol	Analog (Ratiometric), PWM, CAN Open, CAN SAE J1939 Serial Protocol (SPI) upon request	
Output	Simple Redundant Full-redundant	
Switch Output	On request	
Resolution	Analog, PWM, CAN SPI	Up to 12 bit Up to 14 bit
Supply voltage <sup>2</sup>	Analog and PWM CAN	5V ±10% 7V to 15V 7V to 32V
Supply current	Single version Redundant version CAN version	Typ 8.5 mA Typ 17 mA Typ 47 mA
Voltage protection	±10V	
Self-diagnostic features	Yes	

<sup>1</sup> Ferromagnetic materials close to the sensor (i.e. shaft, mounting surface) may affect the sensor's linearity.

<sup>2</sup> Voltages up to 25V possible on request.

### ENVIRONMENTAL SPECIFICATIONS

Operating and storage temperature <sup>1</sup>	-40° to +125°C
Shock	50g
Vibration	5Hz to 2000 Hz; 20g; A <sub>max</sub> 0,75 mm
Sealing <sup>2</sup>	IP67, IP69K
Approval	CE <sup>2</sup>

<sup>1</sup> Other specifications available

<sup>2</sup> CE-approval applies to analogic models with M001 magnet

### EMI/EMC Testing

Characteristic	Standard	Level
Radiated emissions	CISPR 16-2-3 class B	30 MHz to 230 MHz, max. 30dB (µV/m) 230 MHz to 1000 MHz, max. 37dB (µV/m)
ESD on housing and connections	EN 61000-4-2:2009	±4 kV contact ±8 kV air
Burst (on supply lines / signal lines)	EN 61000-4-4:2012	±1kV
Surge (on supply lines / signal lines)	EN 61000-4-5:2014	±1kV
Immunity HF radiated (80 ... 2000 MHz)	EN 61000-4-3:2006	10 V/m
Immunity HF conducted (0,15 ... 80MHz)	EN 61000-4-6:2014	10 Vemk
Immunity magnetic field (50 Hz)	EN 61000-4-8:2010	30 A/m

# PS2P-CON

## Touchless Concentric Rotary Hall-Effect Position Sensor

### DIMENSIONS (MM)

PS2P-CON-CE-M001

PS2P-CON-CE-M006

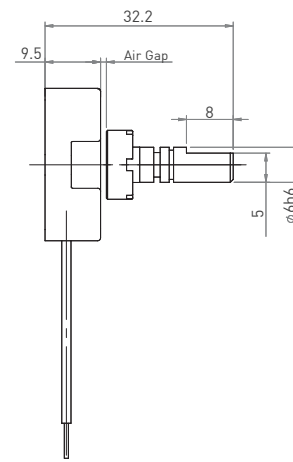
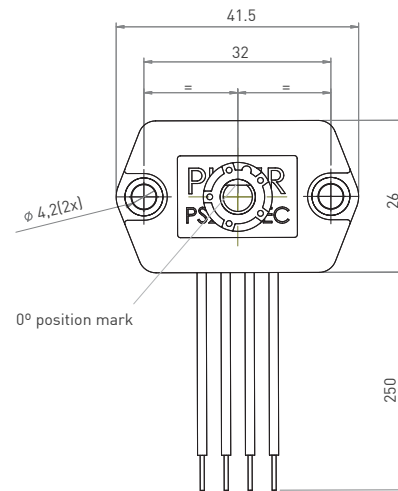
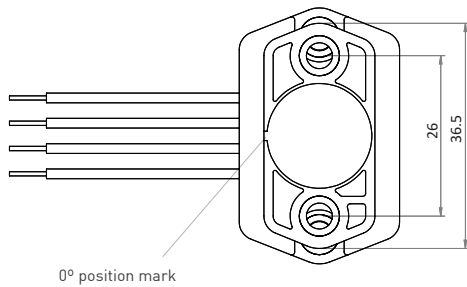
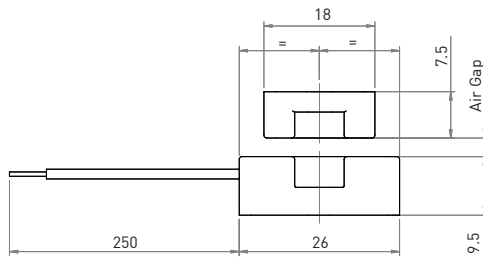
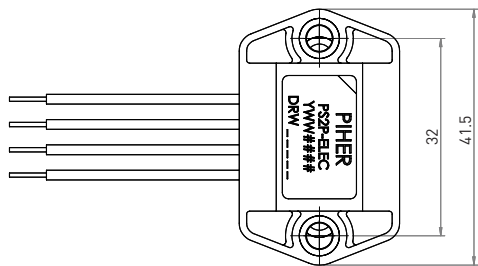
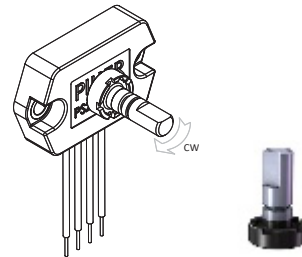
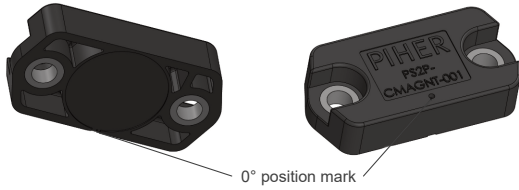

Product configurator and STEP files here:  
[www.piher.net](http://www.piher.net)

Magnet shown on 0° position. Drawings may not be to scale. Number and function of wires pictured in this datasheet may vary according to output configuration.

# PS2P-CON

## Touchless Concentric Rotary Hall-Effect Position Sensor

HOW TO ORDER (Example: PS2P-CON-CE-M001-1A0-C0000-ERA360-05)

### Simple Output

PS2P-CON-CE	-	---	-	1	-	---	-	C	---	-	ERA	---	-	---	-	---
Series	Magnet Model	Type	Output <sup>1</sup>	Output function <sup>2</sup>	Electric rotational angle <sup>3</sup>	Voltage supply <sup>4</sup>	PWM Frequency Hz <sup>5</sup>									
	M001 M006	1 = simple	A0 = analogic P0 = PWM J0 = CAN SAE J1939 O0 = CAN OPEN	C0000 C0001	ERA040 ERA041 ... ERA360	05 = 5V ±10% RE = 7V-15V (A&PWM) / 7V-32V (CAN)	[empty] = 200Hz F100 = 100Hz F101 = 101Hz ... F999 = 999Hz									

### Redundant output

PS2P-CON-CE	-	---	-	2	-	---	-	C	---	-	ERA	---	-	---	-	---
Series	Magnet Model	Type	Output <sup>1</sup>	Output function <sup>2</sup>	Electric rotational angle <sup>3</sup>	Voltage supply <sup>4</sup>	PWM Frequency Hz (1) <sup>5</sup>	PWM Frequency Hz (1) <sup>5</sup>								
	M001 M006	2 = redundant	AA = analogic PP = PWM	C0002 C0003	ERA040 ERA041 ... ERA360	05 = 5V ±10% RE = 7V-15V	[empty] = 200Hz F100 = 100Hz F101 = 101Hz ... F999 = 999Hz	[empty] = 200Hz F100 = 100Hz F101 = 101Hz ... F999 = 999Hz								

### Full-redundant output

PS2P-CON-CE	-	---	-	3	-	---	-	C	---	-	ERA	---	-	05	-	---
Series	Magnet Model	Type	Output <sup>1</sup>	Output function <sup>2</sup>	Electric rotational angle <sup>3</sup>	Voltage supply	PWM Frequency Hz (1) <sup>5</sup>	PWM Frequency Hz (1) <sup>5</sup>								
	M001 M006	3 = full-redundant	AA = analogic PP = PWM	C0002 C0003	ERA040 ERA041 ... ERA360	05 = 5V ±10%	[empty] = 200Hz F100 = 100Hz F101 = 101Hz ... F999 = 999Hz	[empty] = 200Hz F100 = 100Hz F101 = 101Hz ... F999 = 999Hz								

1 The analog output is ratiometric, proportional:  
- for supply voltage "5V" to input voltage;  
- for supply voltage "RE" to 5V.

2 Other output functions available, please check availability. Enter CXXXX as long as the new output function is not defined.

3 Models with ERA < 40° available on request

4 Voltages up to 25V possible on request.

5 Leave empty if not applicable. Default frequency is 200 Hz

### OUTPUT FUNCTIONS

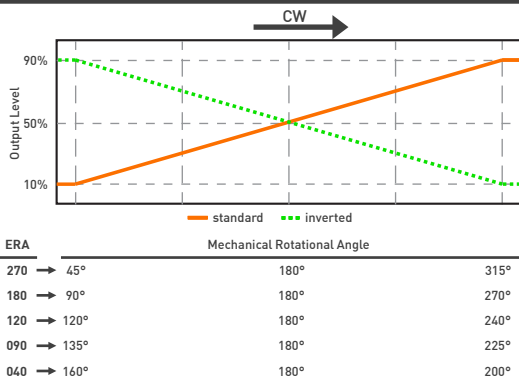

ERA	Standard	Inverted	Redundant
360°	C0000	C0001	C0002
270°	C0208	C0158	C0031
180°	C0007	C0072	C0036
120°	C0024	On request	C0032
90°	C0011		C0025
70°	C0150		C0149
60°	C0006		C0020
40°	C0026		C0123

Custom output functions on request.

# PS2P-CON

## Touchless Concentric Rotary Hall-Effect Position Sensor

### OUTPUT VOLTAGE DEPENDING ON MAGNET POSITION

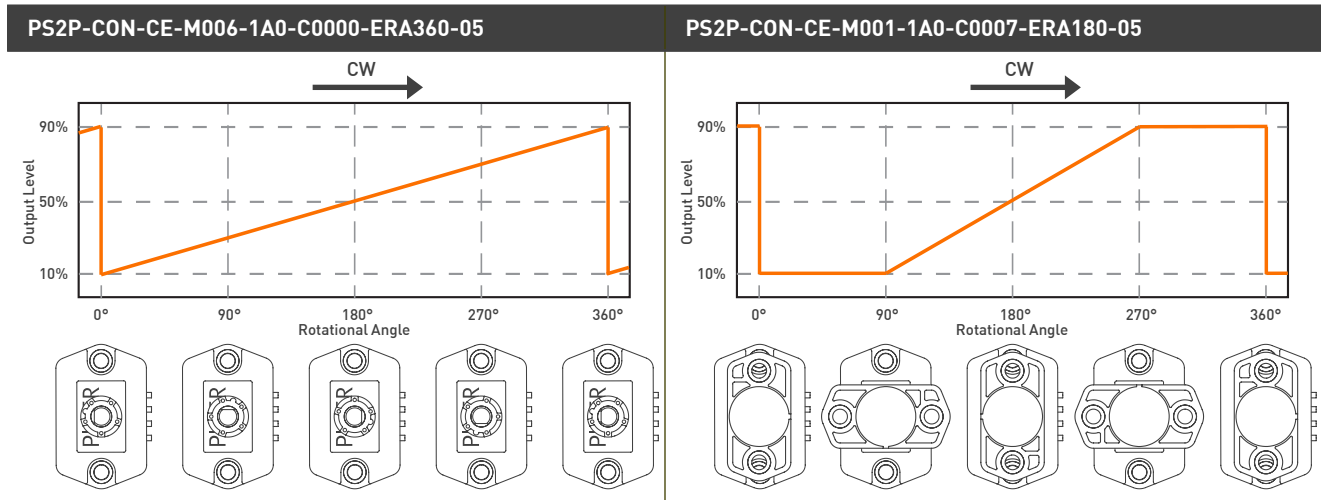

Custom output functions with up to 4 programmable points on request.

### CONNECTION SCHEME

Color	Simple		Redundant		Full-redundant	CAN
	5V	7V to 15V	5V	7V to 15V		
Brown	Power supply	Power supply	Power supply	Power supply	Power supply 1	Power supply
Blue	Ground	Ground	Ground	Ground	Ground 1	Ground
Black	Signal output	Signal output	Signal output 1	Signal output 1	Ground 2	CAN High
White	n/a	n/a	Signal output 2	Signal output 2	Signal output 2	CAN Low
Red	n/a	n/a	n/a	n/a	Power supply 2	n/a
Yellow	n/a	n/a	n/a	n/a	Signal output 1	n/a
Grey	n/a	Not used	n/a	Not used	n/a	n/a

More instructions of use on [www.piher.net](http://www.piher.net). Connector assembly available on request.

### OUR ADVANTAGE

- ▶ Leading-edge innovative position sensing solutions
  - ▷ Contactless (Hall-effect and Inductive Technology)
  - ▷ Contacting (Potentiometers, Printed Electronics)
- ▶ Engineering design-in support
- ▶ All our products can be customized to fit target application and customer requirement
- ▶ Capability to move seamlessly from development to true high-volume production
- ▶ A global footprint with global engineering and commercial support
- ▶ One-stop shop not limited to position sensors (temperature, pressure, gas,...) through group collaboration
- ▶ Flexibility and entrepreneurship of a medium-sized company with the backing of Amphenol Corporation



Please always use the latest updated datasheets and 3D models published on our website.

#### Disclaimer:

The product information in this catalog is for reference purposes. Please consult for the most up to date and accurate design information. Piher Sensors & Controls S.A., its affiliates, agents, and employees, and all persons acting on its or their behalf (collectively, "Piher"), disclaim any and all liability for any errors, inaccuracies or incompleteness contained herein or in any other disclosure relating to any product described herein. Piher disclaims any and all liability arising out of the use or application of any product described herein to the maximum extent permitted by law. The product specifications do not expand or otherwise modify Piher's terms and conditions of sale, including but not limited to the warranty expressed therein, which apply to these products. No license, express or implied, by estoppel or otherwise, to any intellectual property rights is granted by this document or by any conduct of Piher. The products shown herein are not designed for use in medical, life-saving, or life-sustaining applications unless otherwise expressly indicated. Customers using or selling Piher products not expressly indicated for use in such applications do so entirely at their own risk and agree to fully indemnify Piher for any damages arising or resulting from such use or sale. Please contact authorized Piher personnel to obtain written terms and conditions regarding products designed for such applications. Product names and markings noted herein may be trademarks of their respective owners. Information contained in and/or attached to this catalog may be subject to export control regulations of the European Community, USA, or other countries. Each recipient of this document is responsible to ensure that usage and/or transfer of any information contained in this document complies with all relevant export control regulations. If you are in any doubt about the export control restrictions that apply to this information, please contact the sender immediately. For any Piher Exports, Note: All products / technologies are EAR99 Classified commodities. Exports from the United States are in accordance with the Export Administration Regulations. Diversion contrary to US law is prohibited.

### CONTACT

**Piher Sensing Systems**  
 Polígono Industrial Municipal  
 Vial T2, N°22  
 31500 Tudela  
 Spain

[sales@piher.net](mailto:sales@piher.net)

Europe: +34 948 820 450  
 Americas: +1 636 251 0855  
 Asia Pacific: +65 9641 8886  
 India: +91 9538 686 586

Rev:13032023 © 2023 Piher Sensors & Controls S.A.