

# PHX18NQ20T

N-channel enhancement mode field-effect transistor

Rev. 01 — 28 August 2000

Product specification

## 1. Description

N-channel enhancement mode field-effect transistor in a plastic package using TrenchMOS™<sup>1</sup> technology.

Product availability:

PHX18NQ20T in SOT186A.

## 2. Features

- TrenchMOS™ technology
- Low on-state resistance
- Fast switching
- Low thermal resistance
- Isolated tab.

## 3. Applications

- Off-line switched mode power supplies
- Television and computer monitor power supplies
- DC to DC converters
- Motor control circuits

## 4. Pinning information

Table 1: Pinning - SOT186A, simplified outline and symbol

Pin	Description	Simplified outline	Symbol
1	gate (g)		
2	drain (d)		
3	source (s)		
Tab	isolated		

1. TrenchMOS is a trademark of Royal Philips Electronics.

## 5. Quick reference data

**Table 2: Quick reference data**

Symbol	Parameter	Conditions	Typ	Max	Unit
$V_{DS}$	drain-source voltage (DC)	$T_j = 25$ to $150$ °C	–	200	V
$I_D$	drain current (DC)	$T_{hs} = 25$ °C; $V_{GS} = 10$ V	–	8.2	A
$P_{tot}$	total power dissipation	$T_{hs} = 25$ °C	–	30	W
$T_j$	junction temperature		–	150	°C
$R_{DSon}$	drain-source on-state resistance	$V_{GS} = 10$ V; $I_D = 8$ A; $T_j = 25$ °C	130	180	mΩ
		$V_{GS} = 10$ V; $I_D = 8$ A; $T_j = 150$ °C	–	450	mΩ

## 6. Limiting values

**Table 3: Limiting values**

In accordance with the Absolute Maximum Rating System (IEC 60134).

Symbol	Parameter	Conditions	Min	Max	Unit
$V_{DS}$	drain-source voltage (DC)	$T_j = 25$ to $150$ °C	–	200	V
$V_{DGR}$	drain-gate voltage (DC)	$T_j = 25$ to $150$ °C; $R_{GS} = 20$ kΩ	–	200	V
$V_{GS}$	gate-source voltage (DC)		–	±20	V
$I_D$	drain current (DC)	$T_{hs} = 25$ °C; $V_{GS} = 10$ V; Figure 2 and 3	–	8.2	A
		$T_{hs} = 100$ °C; $V_{GS} = 10$ V; Figure 2	–	5.2	A
$I_{DM}$	peak drain current	$T_{hs} = 25$ °C; pulsed; $t_p \leq 10$ μs; Figure 3	–	33	A
$P_{tot}$	total power dissipation	$T_{hs} = 25$ °C; Figure 1	–	30	W
$T_{stg}$	storage temperature		–55	+150	°C
$T_j$	operating junction temperature		–55	+150	°C

### Source-drain diode

$I_S$	source (diode forward) current (DC)	$T_{amb} = 25$ °C	–	8.2	A
$I_{SM}$	peak source (diode forward) current	$T_{amb} = 25$ °C; pulsed; $t_p \leq 10$ μs	–	33	A

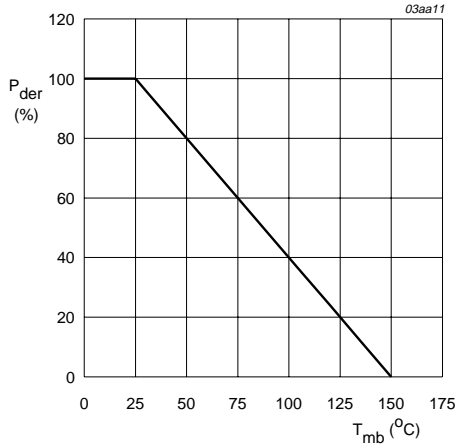

$$P_{der} = \frac{P_{tot}}{P_{tot(25^{\circ}C)}} \times 100\%$$

Fig 1. Normalized total power dissipation as a function of ambient temperature.

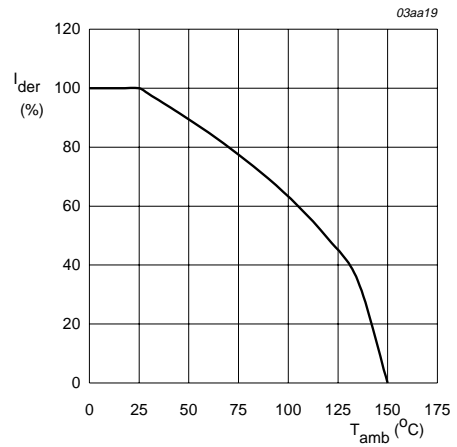

$$V_{GS} \geq 4.5 \text{ V}$$

$$I_{der} = \frac{I_D}{I_{D(25^{\circ}C)}} \times 100\%$$

Fig 2. Normalized continuous drain current as a function of ambient temperature.

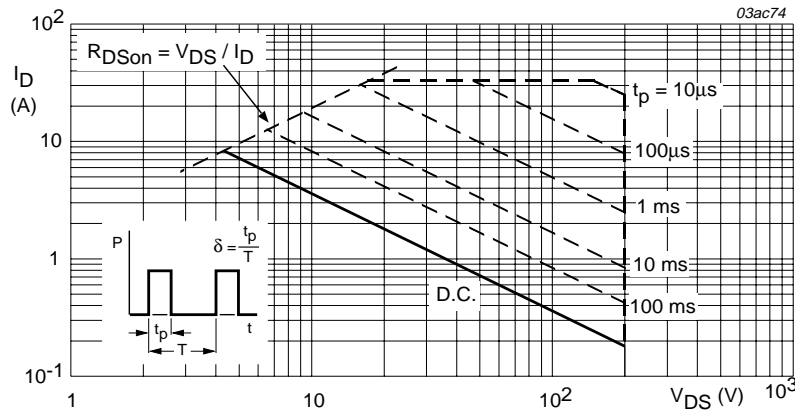

T<sub>amb</sub> = 25 °C; I<sub>DM</sub> is single pulse.

Fig 3. Safe operating area; continuous and peak drain currents as a function of drain-source voltage.

## 7. Thermal characteristics

Table 4: Thermal characteristics

Symbol	Parameter	Conditions	Value	Unit
$R_{th(j-hs)}$	thermal resistance from junction to heatsink		4.17	K/W
$R_{th(j-a)}$	thermal resistance from junction to ambient	vertical in still air; lead length $\leq 5$ mm; <a href="#">Figure 4</a>	55	K/W

### 7.1 Transient thermal impedance

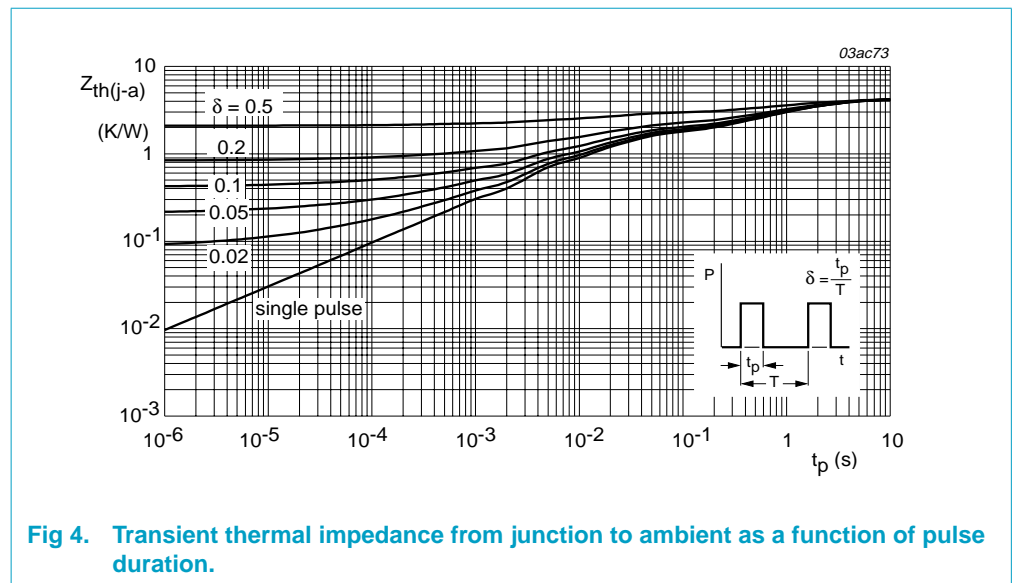
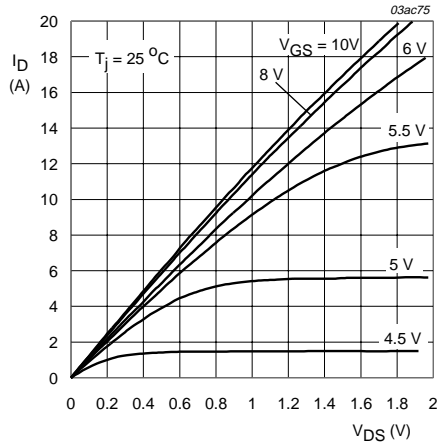

Fig 4. Transient thermal impedance from junction to ambient as a function of pulse duration.

## 8. Characteristics

**Table 5: Characteristics**
*T<sub>j</sub> = 25 °C unless otherwise specified*

Symbol	Parameter	Conditions	Min	Typ	Max	Unit
<b>Static characteristics</b>						
V <sub>(BR)DSS</sub>	drain-source breakdown voltage	I <sub>D</sub> = 0.25 mA; V <sub>GS</sub> = 0 V T <sub>j</sub> = 25 °C	200	–	–	V
		T <sub>j</sub> = –55 °C	178	–	–	V
V <sub>GS(th)</sub>	gate-source threshold voltage	I <sub>D</sub> = 1 mA; V <sub>DS</sub> = V <sub>GS</sub> ; Figure 9				
		T <sub>j</sub> = 25 °C	2	3	4	V
		T <sub>j</sub> = 150 °C	1.2	–	–	V
		T <sub>j</sub> = –55 °C	–	–	6	V
I <sub>DSS</sub>	drain-source leakage current	V <sub>DS</sub> = 200 V; V <sub>GS</sub> = 0 V T <sub>j</sub> = 25 °C	–	0.05	10	μA
		T <sub>j</sub> = 150 °C	–	–	100	μA
I <sub>GSS</sub>	gate-source leakage current	V <sub>GS</sub> = ±10 V; V <sub>DS</sub> = 0 V	–	10	100	nA
R <sub>DS(on)</sub>	drain-source on-state resistance	V <sub>GS</sub> = 10 V; I <sub>D</sub> = 8 A; Figure 7 and 8				
		T <sub>j</sub> = 25 °C	–	130	180	mΩ
		T <sub>j</sub> = 150 °C	–	–	450	mΩ
<b>Dynamic characteristics</b>						
g <sub>fs</sub>	forward transconductance	V <sub>DS</sub> = 25 V; I = 8 A; Figure 11	–	15	–	S
C <sub>iss</sub>	input capacitance	V <sub>GS</sub> = 0 V; V <sub>DS</sub> = 25 V;	–	1850	–	pF
C <sub>oss</sub>	output capacitance	f = 1 MHz; Figure 12	–	170	–	pF
C <sub>rss</sub>	reverse transfer capacitance		–	91	–	pF
Q <sub>g(tot)</sub>	total gate charge	I <sub>D</sub> = 18 A; V <sub>DD</sub> = 160 V;	–	40	–	nC
Q <sub>gs</sub>	gate-source charge	V <sub>GS</sub> = 10 V; Figure 14	–	9	–	nC
Q <sub>gd</sub>	gate-drain (Miller) charge		–	22	–	nC
t <sub>on</sub>	turn-on time	V <sub>DD</sub> = 100 V; R <sub>D</sub> = 5.6 Ω;	–	3	–	ns
t <sub>off</sub>	turn-off time	V <sub>GS</sub> = 10 V; R <sub>G</sub> = 5.6 Ω; Resistive load	–	92	–	ns
<b>Source-drain diode</b>						
V <sub>SD</sub>	source-drain (diode forward) voltage	I <sub>S</sub> = 16 A; V <sub>GS</sub> = 0 V; Figure 13	–	0.9	1.2	V
t <sub>rr</sub>	reverse recovery time	I <sub>S</sub> = 16 A;	–	130	–	ns
Q <sub>r</sub>	recovered charge	dI <sub>S</sub> /dt = –100 A/μs; V <sub>GS</sub> = 0 V; V <sub>DS</sub> = 25 V	–	0.8	–	μC



$T_j = 25\text{ }^\circ\text{C}$

**Fig 5. Output characteristics: drain current as a function of drain-source voltage; typical values.**

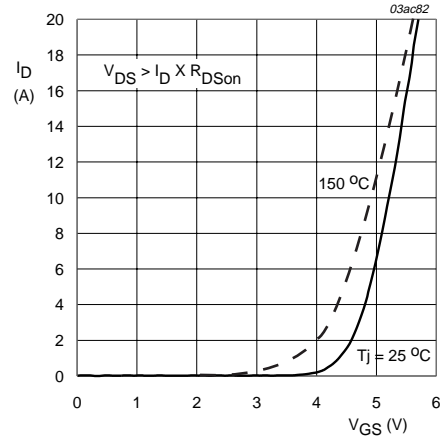

$T_j = 25\text{ }^\circ\text{C}$  and  $150\text{ }^\circ\text{C}$ ;  $V_{DS} > I_D \times R_{DSon}$

**Fig 6. Transfer characteristics: drain current as a function of gate-source voltage; typical values.**

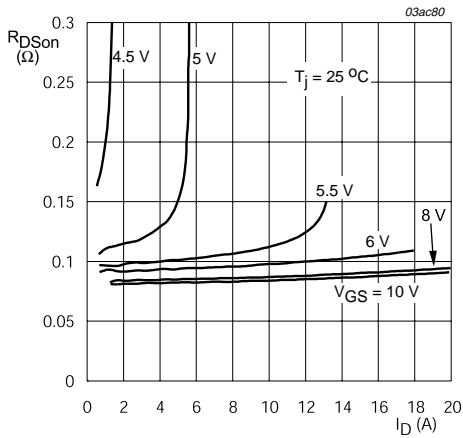

$T_j = 25\text{ }^\circ\text{C}$

**Fig 7. Drain-source on-state resistance as a function of drain current; typical values.**

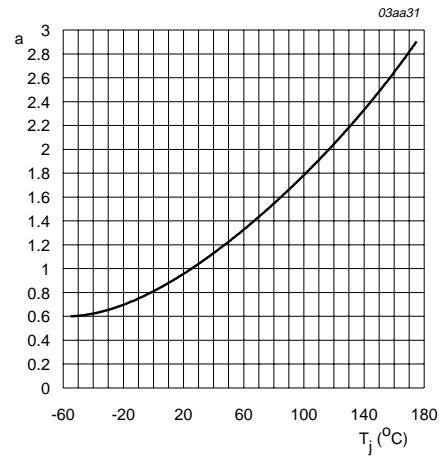

$$a = \frac{R_{DSon}}{R_{DSon(25^\circ\text{C})}}$$

**Fig 8. Normalized drain-source on-state resistance factor as a function of junction temperature.**



$I_D = 1 \text{ mA}; V_{DS} = V_{GS}$

**Fig 9. Gate-source threshold voltage as a function of junction temperature.**

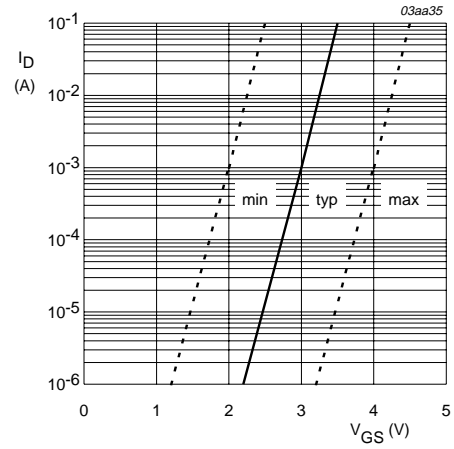

$T_j = 25 \text{ }^{\circ}C; V_{DS} = 5 \text{ V}$

**Fig 10. Sub-threshold drain current as a function of gate-source voltage.**

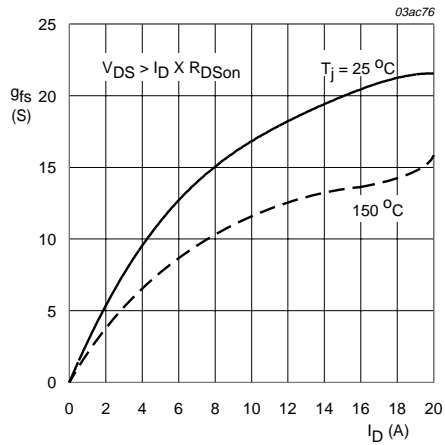

$T_j = 25 \text{ }^{\circ}C \text{ and } 150 \text{ }^{\circ}C; V_{DS} > I_D \times R_{DSon}$

**Fig 11. Forward transconductance as a function of drain current; typical values.**

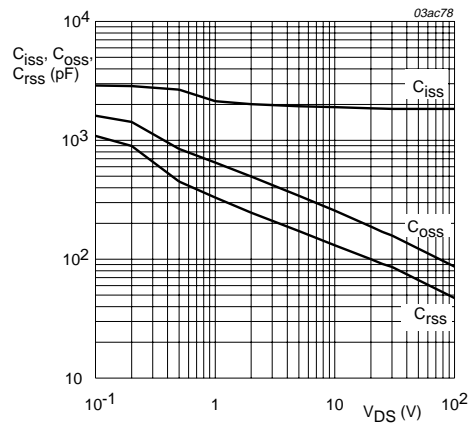

$V_{GS} = 0 \text{ V}; f = 1 \text{ MHz}$

**Fig 12. Input, output and reverse transfer capacitances as a function of drain-source voltage; typical values.**

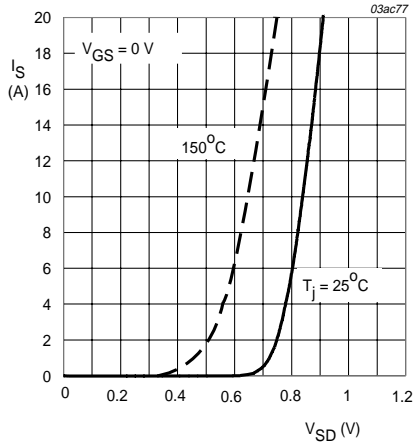

$T_j = 25^\circ\text{C}$  and  $150^\circ\text{C}$ ;  $V_{GS} = 0$  V

Fig 13. Source (diode forward) current as a function of source-drain (diode forward) voltage; typical values.

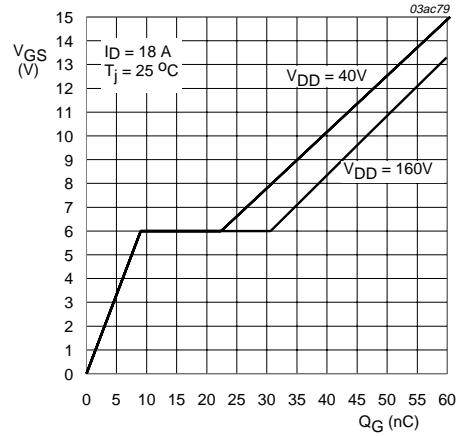

Fig 14. Gate-source voltage as a function of gate charge; typical values.

## 9. Isolation characteristics

Table 6: Isolation characteristics

Symbol	Parameter	Conditions	Min.	Typ.	Max.	Unit
$V_{isol}$	RMS isolation voltage from all three terminals to external heatsink.	$f = 50\text{-}60$ Hz; sinusoidal waveform; $RH \leq 65\%$ ; clean and dust-free.	–	–	2500	V
$C_{isol}$	Capacitance from pin 2 (drain) to external heatsink.		–	10	–	pF



10. Package outline

Plastic single-ended package; isolated heatsink mounted;  
1 mounting hole; 3 lead TO-220 'full pack'

SOT186A

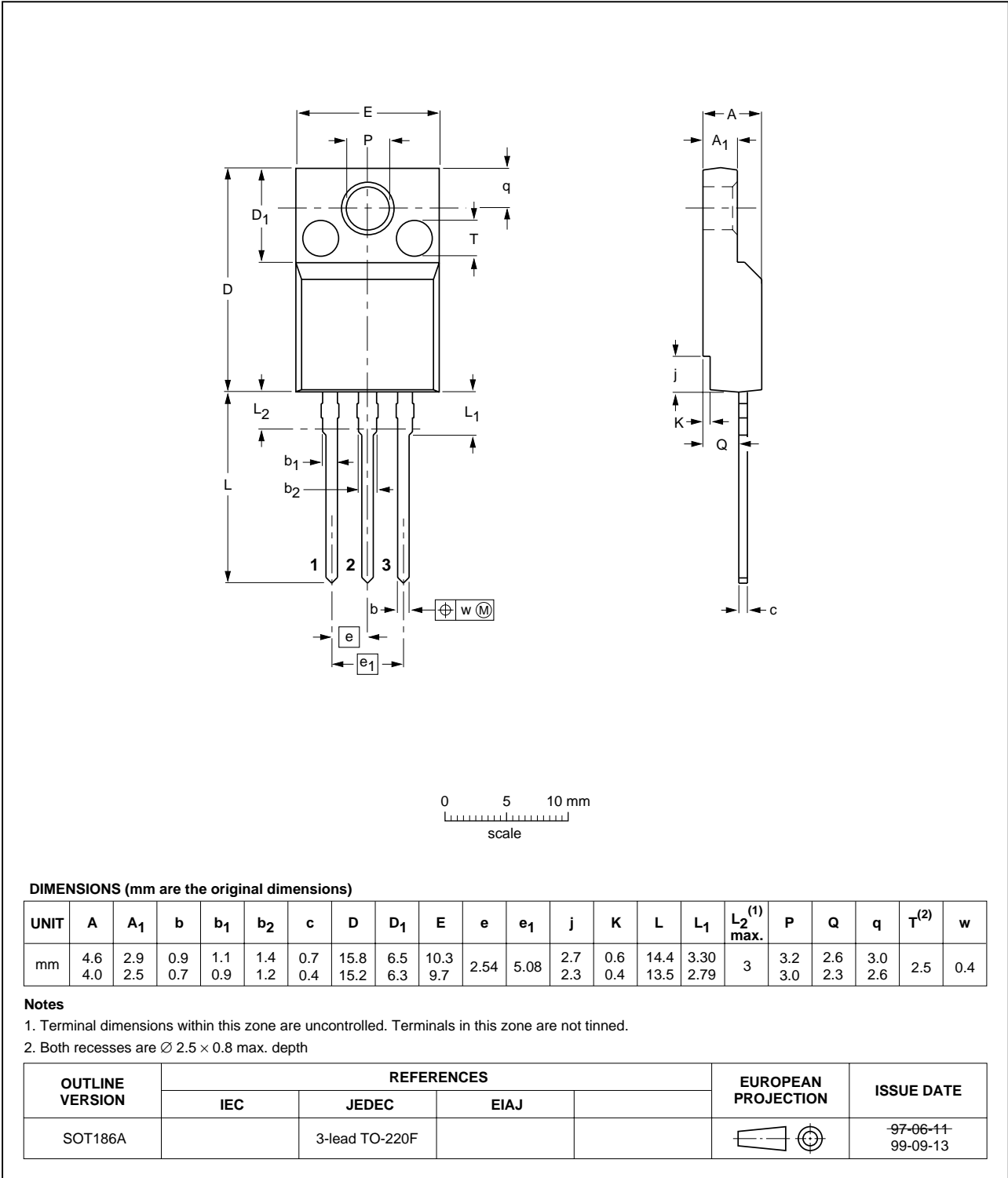

Fig 15. SOT186A.

## 11. Revision history

Table 7: Revision history

Rev	Date	CPCN	Description
01	20000828	-	Product specification.

## 12. Data sheet status

Datasheet status	Product status	Definition <sup>[1]</sup>
Objective specification	Development	This data sheet contains the design target or goal specifications for product development. Specification may change in any manner without notice.
Preliminary specification	Qualification	This data sheet contains preliminary data, and supplementary data will be published at a later date. Philips Semiconductors reserves the right to make changes at any time without notice in order to improve design and supply the best possible product.
Product specification	Production	This data sheet contains final specifications. Philips Semiconductors reserves the right to make changes at any time without notice in order to improve design and supply the best possible product.

[1] Please consult the most recently issued data sheet before initiating or completing a design.

## 13. Definitions

**Short-form specification** — The data in a short-form specification is extracted from a full data sheet with the same type number and title. For detailed information see the relevant data sheet or data handbook.

**Limiting values definition** — Limiting values given are in accordance with the Absolute Maximum Rating System (IEC 60134). Stress above one or more of the limiting values may cause permanent damage to the device. These are stress ratings only and operation of the device at these or at any other conditions above those given in the Characteristics sections of the specification is not implied. Exposure to limiting values for extended periods may affect device reliability.

**Application information** — Applications that are described herein for any of these products are for illustrative purposes only. Philips Semiconductors make no representation or warranty that such applications will be suitable for the specified use without further testing or modification.

## 14. Disclaimers

**Life support** — These products are not designed for use in life support appliances, devices, or systems where malfunction of these products can reasonably be expected to result in personal injury. Philips Semiconductors customers using or selling these products for use in such applications do so at their own risk and agree to fully indemnify Philips Semiconductors for any damages resulting from such application.

**Right to make changes** — Philips Semiconductors reserves the right to make changes, without notice, in the products, including circuits, standard cells, and/or software, described or contained herein in order to improve design and/or performance. Philips Semiconductors assumes no responsibility or liability for the use of any of these products, conveys no licence or title under any patent, copyright, or mask work right to these products, and makes no representations or warranties that these products are free from patent, copyright, or mask work right infringement, unless otherwise specified.





## Philips Semiconductors - a worldwide company

**Argentina:** see South America

**Australia:** Tel. +61 2 9704 8141, Fax. +61 2 9704 8139

**Austria:** Tel. +43 160 101, Fax. +43 160 101 1210

**Belarus:** Tel. +375 17 220 0733, Fax. +375 17 220 0773

**Belgium:** see The Netherlands

**Brazil:** see South America

**Bulgaria:** Tel. +359 268 9211, Fax. +359 268 9102

**Canada:** Tel. +1 800 234 7381

**China/Hong Kong:** Tel. +852 2 319 7888, Fax. +852 2 319 7700

**Colombia:** see South America

**Czech Republic:** see Austria

**Denmark:** Tel. +45 3 288 2636, Fax. +45 3 157 0044

**Finland:** Tel. +358 961 5800, Fax. +358 96 158 0920

**France:** Tel. +33 14 099 6161, Fax. +33 14 099 6427

**Germany:** Tel. +49 40 23 5360, Fax. +49 402 353 6300

**Hungary:** see Austria

**India:** Tel. +91 22 493 8541, Fax. +91 22 493 8722

**Indonesia:** see Singapore

**Ireland:** Tel. +353 17 64 0000, Fax. +353 17 64 0200

**Israel:** Tel. +972 36 45 0444, Fax. +972 36 49 1007

**Italy:** Tel. +39 039 203 6838, Fax +39 039 203 6800

**Japan:** Tel. +81 33 740 5130, Fax. +81 3 3740 5057

**Korea:** Tel. +82 27 09 1412, Fax. +82 27 09 1415

**Malaysia:** Tel. +60 37 50 5214, Fax. +60 37 57 4880

**Mexico:** Tel. +9-5 800 234 7381

**Middle East:** see Italy

**For all other countries apply to:** Philips Semiconductors,  
Marketing Communications,  
Building BE, P.O. Box 218, 5600 MD EINDHOVEN,  
The Netherlands, Fax. +31 40 272 4825

**Netherlands:** Tel. +31 40 278 2785, Fax. +31 40 278 8399

**New Zealand:** Tel. +64 98 49 4160, Fax. +64 98 49 7811

**Norway:** Tel. +47 22 74 8000, Fax. +47 22 74 8341

**Philippines:** Tel. +63 28 16 6380, Fax. +63 28 17 3474

**Poland:** Tel. +48 22 5710 000, Fax. +48 22 5710 001

**Portugal:** see Spain

**Romania:** see Italy

**Russia:** Tel. +7 095 755 6918, Fax. +7 095 755 6919

**Singapore:** Tel. +65 350 2538, Fax. +65 251 6500

**Slovakia:** see Austria

**Slovenia:** see Italy

**South Africa:** Tel. +27 11 471 5401, Fax. +27 11 471 5398

**South America:** Tel. +55 11 821 2333, Fax. +55 11 829 1849

**Spain:** Tel. +34 33 01 6312, Fax. +34 33 01 4107

**Sweden:** Tel. +46 86 32 2000, Fax. +46 86 32 2745

**Switzerland:** Tel. +41 14 88 2686, Fax. +41 14 81 7730

**Taiwan:** Tel. +886 22 134 2451, Fax. +886 22 134 2874

**Thailand:** Tel. +66 23 61 7910, Fax. +66 23 98 3447

**Turkey:** Tel. +90 216 522 1500, Fax. +90 216 522 1813

**Ukraine:** Tel. +380 44 264 2776, Fax. +380 44 268 0461

**United Kingdom:** Tel. +44 208 730 5000, Fax. +44 208 754 8421

**United States:** Tel. +1 800 234 7381

**Uruguay:** see South America

**Vietnam:** see Singapore

**Yugoslavia:** Tel. +381 11 3341 299, Fax. +381 11 3342 553

**Internet:** <http://www.semiconductors.philips.com>

(SCA70)

Contents

1 Description . . . . . 1

2 Features . . . . . 1

3 Applications . . . . . 1

4 Pinning information . . . . . 1

5 Quick reference data . . . . . 2

6 Limiting values . . . . . 2

7 Thermal characteristics . . . . . 4

7.1 Transient thermal impedance . . . . . 4

8 Characteristics . . . . . 5

9 Isolation characteristics . . . . . 8

10 Package outline . . . . . 9

11 Revision history . . . . . 10

12 Data sheet status . . . . . 11

13 Definitions . . . . . 11

14 Disclaimers . . . . . 11



**PHILIPS**

*Let's make things better.*