

## SPECIFICATIONS

<b>CUSTOMER</b>	:	_____
<b>SAMPLE CODE</b>	:	SH128800T004-ZFA01
<b>MASS PRODUCTION CODE</b>	:	PH128800T004-ZFA01
<b>SAMPLE VERSION</b>	:	01
<b>SPECIFICATIONS EDITION</b>	:	006
<b>DRAWING NO. (Ver.)</b>	:	LMD-PH128800T004-ZFA01 (Ver.003)
<b>PACKAGING NO. (Ver.)</b>	:	PKG-PH128800T004-ZFA01 (Ver.003)

**Customer Approved**

**Date:**

Approved	Checked	Designer
黃秋源 Oliver Huang	石建莊 Stone Shin	王聖硯 Stephen Wang

- Preliminary specification for design input
- Specification for sample approval

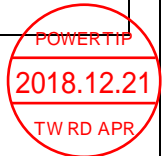

### POWERTIP TECH. CORP.

<b>Headquarters:</b> No.8, 6 <sup>th</sup> Road, Taichung Industrial Park, Taichung, Taiwan 台中市 407 工業區六路 8 號	TEL: 886-4-2355-8168 FAX: 886-4-2355-8166	E-mail: <a href="mailto:sales@powertip.com.tw">sales@powertip.com.tw</a> Http://www.powertip.com.tw
---	--	--

## History of Version

Date	Ver.	Edi.	Description	Page	Design by
04/11/2017	01	001	New Drawing.	-	Stephen
05/20/2017	01	002	New Sample	-	Stephen
07/19/2017	01	003	Modify Spec Update Packages Version	10	Stephen
10/18/2017	01	004	Modify Specifications Features	4	Stephen
	01	004	Update LCD Module Drawing Version	-	Stephen
05/09/2018	01	005	Modify Spec	-	Stephen
12/20/2018	01	006	Modify Spec 1.1 Features - Display Mode 1.3 Maximum Ratings - Operating Temperature 1.4 DC Electrical Characteristics	4、5	Stephen

Total: 27 Page

## Contents

### 1. SPECIFICATIONS

- 1.1 Features
- 1.2 Mechanical Specifications
- 1.3 Absolute Maximum Ratings
- 1.4 DC Electrical Characteristics
- 1.5 Optical Characteristics
- 1.6 Backlight Characteristics

### 2. MODULE STRUCTURE

- 2.1 Counter Drawing
- 2.2 Interface Pin Description
- 2.3 HDMI Characteristics

### 3. QUALITY ASSURANCE SYSTEM

- 3.1 Quality Assurance Flow Chart
- 3.2 Inspection Specification

### 4. RELIABILITY TEST

- 4.1 Reliability Test Condition

### 5. PRECAUTION RELATING PRODUCT HANDLING

- 5.1 Safety
- 5.2 Handling
- 5.3 Storage
- 5.4 Terms of Warranty

Appendix : LCM Drawing.  
LCM Packaging Specifications

## 1. SPECIFICATIONS

### 1.1 Features

Item	Standard Value
Screen Size(inch)	10.1(Diagonal)
Resolution	1280* (R、G、B) * 800 Dots
Display Mode	Full Viewing Angle、Transmissive、Normally Black
Color	16.7M
Weight	256.7 g
Interface	HDMI
ROHS	THIS PRODUCT CONFORMS THE ROHS OF PTC Detail information please refer website : <a href="http://www.powertip.com.tw/news_detail.php?Key=1&amp;cID=1">http://www.powertip.com.tw/news_detail.php?Key=1&amp;cID=1</a>

### 1.2 Mechanical Specifications

Item	Standard Value	Unit
Outline Dimension	229.8(W) * 149.0 (L) * 23.6 (H)	mm

#### LCD panel

Item	Standard Value	Unit
Active Area	216.96 (W) * 135.60 (L)	mm

Note : For detailed information please refer to LCM drawing.

### 1.3 Absolute Maximum Ratings

Item	Symbol	Condition	Min.	Max.	Unit
Power Supply Voltage	VCC	-	-0.3	+23.0	V
	V <sub>Bus</sub>	-	-0.3	+6.0	V
Logic Voltage	BL_PWM	-	-0.3	+5.5	V
Operating Temperature	T <sub>OP</sub>	-	-20	+70	°C
Storage Temperature	T <sub>ST</sub>	-	-30	+80	°C
Storage Humidity	H <sub>D</sub>	T <sub>a</sub> < 60 °C	-	90	%RH

### 1.4 DC Electrical Characteristics

Item	Symbol	Status	Condition	Min.	Typ.	Max.	Unit
Power Supply Voltage	VCC	I	VCC-GND	11.5	12.0	12.5	V
	V <sub>Bus</sub>	I	V <sub>Bus</sub> -GND	4.75	5.0	5.25	V
Power Supply Current	ICC	I	VCC=12.0v	-	500	550	mA
	I <sub>Bus</sub>	I	V <sub>Bus</sub> =5.0v	-	50	100	mA
Logic Voltage	BL_PWM	-	BL_EN=5.0v	0	-	5.0	V
PWM Frequency	FPWM	-	-	100	-	20000	HZ

Note: Maximum current from RGB full-display

## 1.5 Optical Characteristics

### TFT LCD Panel

Ta=25°C

Item	Symbol	Condition	Min.	Typ.	Max.	Unit	-	
Response Time	Tr + Tf	-	-	25	50	ms	Note2	
Viewing Angle	Top	ΘY+	CR ≥ 10	75	85	-	Deg.	Note4
	Bottom	ΘY-		75	85	-		
	Left	ΘX-		75	85	-		
	Right	ΘX+		75	85	-		
Contrast Ratio	CR	-	600	800	-	-	Note3	
Color of CIE Coordinate (With B/L )	White	X	-	0.268	0.318	0.368	-	Note1
		Y		0.302	0.352	0.402		
	Red	X		0.541	0.591	0.641		
		Y		0.300	0.350	0.400		
	Green	X		0.293	0.343	0.393		
		Y		0.534	0.584	0.634		
	Blue	X		0.104	0.154	0.204		
		Y		0.099	0.149	0.199		
Average Brightness Pattern=White Display	IV	IF=80 mA	400	500	-	cd/m <sup>2</sup>	Note1	
Luminance Uniformity	YU	IF=80 mA	70	75	-	%	Note1	

Note1:

1 :  $\Delta B = B(\min) / B(\max) \times 100\%$

2 : Measurement Condition for Optical Characteristics:

a : Environment: 25°C ± 5°C / 60 ± 20% R.H , no wind , dark room below 10 Lux at typical lamp current and typical operating frequency.

b : Measurement Distance: 500 ± 50 mm , (θ = 0°)

c : Equipment: TOPCON BM-7 fast , (field 1°) , after 10 minutes operation.

d : The uncertainty of the C.I.E coordinate measurement ± 0.01 , Average Brightness ± 4%

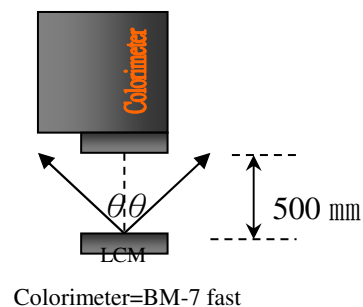
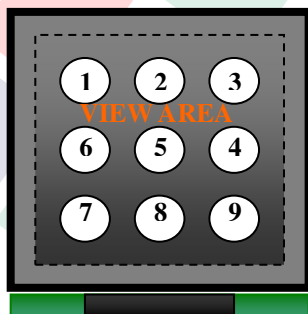

**Note2: Definition of response time:**

The output signals of photo detector are measured when the input signals are changed from "black" to "white"(falling time) and from "white" to "black"(rising time), respectively. The response time is defined as the time interval between the 10% and 90% of Amplitudes.

Refer to figure as below:

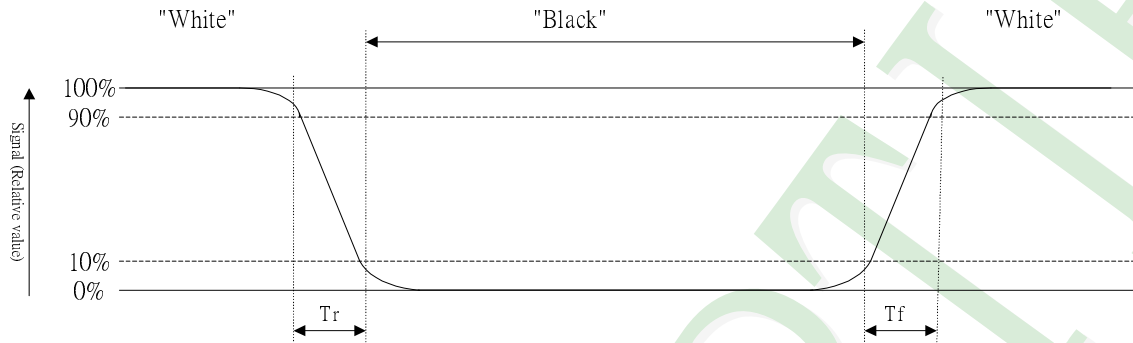

**Note3: Definition of contrast ratio:**

Contrast ratio is calculated with the following formula

$$\text{Contrast ratio (CR)} = \frac{\text{Photo detector output when LCD is at "White" state}}{\text{Photo detector output when LCD is at "Black" state}}$$

**Note4: Definition of viewing angle:**

Refer to figure as below:

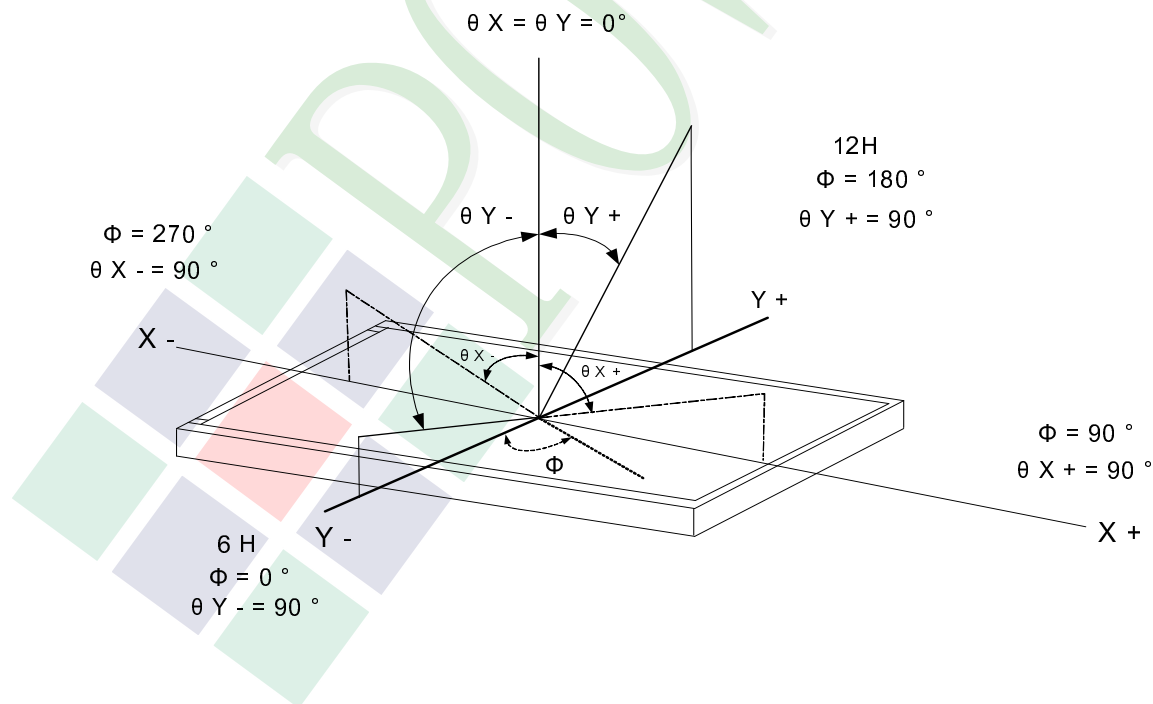

## 1.6 Backlight Characteristics

### Maximum Ratings

Item	Symbol	Conditions	Min.	Typ.	Max.	Unit
Power Dissipation	Pd	-	-	100	-	mW
LED Forward Current	IF	1 LED	-	-	30	mA
LED Reverse Voltage	VR	1 LED	-	-	1.2	V

### Electrical / Optical Characteristics

Item	Symbol	Conditions	Min.	Typ.	Max.	Unit
Voltage for LED Backlight	VF	If=80mA	27.5	31.0	34.0	V
Current for LED Backlight	IF		-	80	-	mA
Color	White					

### Other Description

Item	Conditions	Description
Life Time	Ta =25°C If= 80 mA	50000 hrs

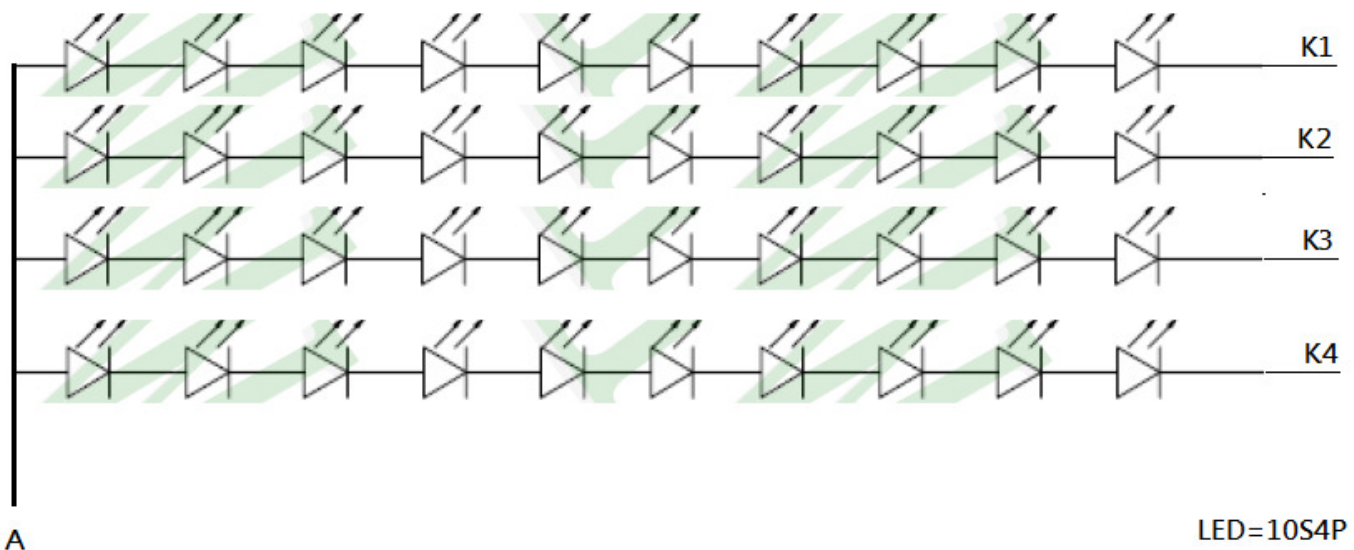



## 2. MODULE STRUCTURE

### 2.1 Counter Drawing

#### 2.1.1 LCM Mechanical Diagram

\* See Appendix

#### 2.1.2 Block Diagram

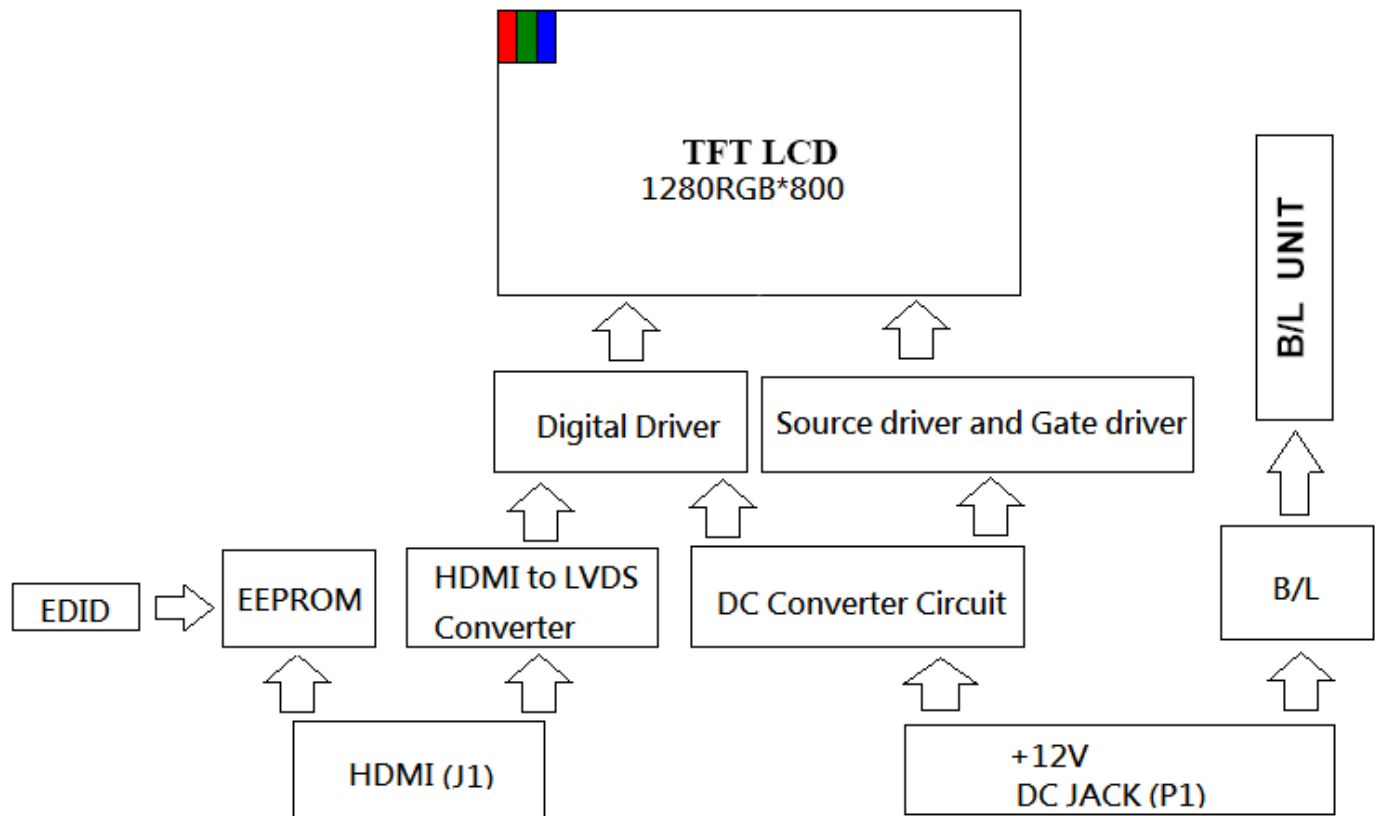

## 2.2 Interface Pin Description

### 2.2.1 (J1:HDMI 1.3 A type Interface)

Pin#	Name	Description
1	TX2+	TMDS Data 2+
2	TX2 Shield	TMDS Data 2 Shield
3	TX2-	TMDS Data 2-
4	TX1+	TMDS Data 1+
5	TX1 Shield	TMDS Data 1 Shield
6	TX1-	TMDS Data 1-
7	TX0+	TMDS Data 0+
8	TX0 Shield	TMDS Data 0 Shield
9	TX0-	TMDS Data 0-
10	TXC+	TMDS Clock+
11	TXC Shield	TMDS Clock Shield
12	TXC-	TMDS Clock-
13	CEC	CEC
14	NC	No connection
15	SCL	Serial Clock for DDC
16	SDA	Serial Data for DDC
17	GND	Power Ground
18	V5V	No connection
19	Hot Plug Detect	Hot Plug Detect

### 2.2.2 (PJ1:POWER DC JACK Interface)

PJ1

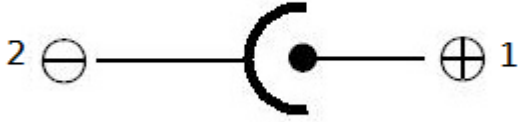

Hold  $\Phi 6.4\text{mm}$  / Center Pin  $\Phi 2.0\text{mm}$

Pin#	Name	Description
1	VCC	+12V Power
2	GND	Power Ground

## 2.3 HDMI Characteristics

### 2.3.1 Signal DC&AC Characteristics

#### DC ELECTRICAL CHARACTERISTICS

over operating free-air temperature range (unless otherwise noted)

PARAMETER	TEST CONDITIONS	MIN	TYP	MAX	UNIT
V <sub>ID</sub>	Analog input differential voltage <sup>(1)</sup>	75		1200	mV
V <sub>IC</sub>	Analog input common-mode voltage <sup>(1)</sup>	AV <sub>DD</sub> – 300		AV <sub>DD</sub> – 37	mV
V <sub>I(OC)</sub>	Open-circuit analog input voltage	AV <sub>DD</sub> – 10		AV <sub>DD</sub> + 10	mV
I <sub>DD(2PIX)</sub>	Normal 2-pix/clock power supply current <sup>(2)</sup>	ODCK = 82.5 MHz, 2-pix/clock		370	mA
I <sub>PD</sub>	Power-down current <sup>(3)</sup>	P <sub>D</sub> = low		10	mA
I <sub>PDO</sub>	Output drive power-down current <sup>(3)</sup>	P <sub>DO</sub> = low		35	mA

(1) Specified as dc characteristic with no overshoot or undershoot

(2) Alternating 2-pixel black/2-pixel white pattern. ST = high, STAG = high, QE[23:0] and QO[23:0] C<sub>L</sub> = 10 pF.

(3) Analog inputs are open circuit (transmitter is disconnected from TFP401/401A).

#### AC ELECTRICAL CHARACTERISTICS

over recommended operating free-air temperature range (unless otherwise noted)

PARAMETER	TEST CONDITIONS	MIN	TYP	MAX	UNIT
V <sub>ID(2)</sub>	Differential input sensitivity <sup>(1)</sup>	150		1560	mV <sub>p-p</sub>
t <sub>ps</sub>	Analog input intra-pair (+ to –) differential skew <sup>(2)</sup>			0.4	t <sub>bit</sub> <sup>(3)</sup>
t <sub>ccs</sub>	Analog input inter-pair or channel-to-channel skew <sup>(2)</sup>			1	t <sub>pix</sub> <sup>(4)</sup>
t <sub>jitter</sub>	Worst-case differential input clock jitter tolerance <sup>(2)(5)</sup>	50			ps
t <sub>f1</sub>	Fall time of data and control signals <sup>(6)(7)</sup>	ST = low, C <sub>L</sub> = 5 pF		2.4	ns
		ST = high, C <sub>L</sub> = 10 pF		1.9	
t <sub>r1</sub>	Rise time of data and control signals <sup>(6)(7)</sup>	ST = low, C <sub>L</sub> = 5 pF		2.4	ns
		ST = high, C <sub>L</sub> = 10 pF		1.9	
t <sub>r2</sub>	Rise time of ODCK clock <sup>(6)</sup>	ST = low, C <sub>L</sub> = 5 pF		2.4	ns
		ST = high, C <sub>L</sub> = 10 pF		1.9	
t <sub>f2</sub>	Fall time of ODCK clock <sup>(6)</sup>	ST = low, C <sub>L</sub> = 5 pF		2.4	ns
		ST = high, C <sub>L</sub> = 10 pF		1.9	
t <sub>su1</sub>	Setup time, data and control signal to falling edge of ODCK	1 pixel/clock, PIXS = low, OCK_INV = low	1.8		ns
		2 pixel/clock, PIXS = high, STAG = high, OCK_INV = low	3.8		
		2 pixel and STAG, PIXS = high, STAG = low, OCK_INV = low	0.7		
t <sub>h1</sub>	Hold time, data and control signal to falling edge of ODCK	1 pixel/clock, PIXS = low, OCK_INV = low	0.6		ns
		2 pixel and STAG, PIXS = high, STAG = low, OCK_INV = low	2.5		
		2 pixel/clock, PIXS = high, STAG = high, OCK_INV = low	2.9		

(1) Specified as ac parameter to include sensitivity to overshoot, undershoot and reflection.

(2) By characterization

(3) t<sub>bit</sub> is 1/10 the pixel time, t<sub>pix</sub>

(4) t<sub>pix</sub> is the pixel time defined as the period of the RxC input clock. The period of ODCK is equal to t<sub>pix</sub> in 1-pixel/clock mode or 2t<sub>pix</sub> when in 2-pixel/clock mode.

(5) Measured differentially at 50% crossing using ODCK output clock as trigger

(6) Rise and fall times measured as time between 20% and 80% of signal amplitude.

(7) Data and control signals are QE[23:0], QO[23:0], DE, HSYNC, VSYNC. and CTL[3:1].

## AC ELECTRICAL CHARACTERISTICS (continued)

over recommended operating free-air temperature range (unless otherwise noted)

PARAMETER		TEST CONDITIONS	MIN	TYP	MAX	UNIT
$t_{su2}$	Setup time, data and control signal to rising edge of ODCK	1 pixel/clock, PIXS = low, OCK_INV = high	2.1			ns
		2 pixel/clock, PIXS = high, STAG = high, OCK_INV = high	4			
		2 pixel and STAG, PIXS = high, STAG = low, OCK_INV = high	1.5			
$t_{h2}$	Hold time, data and control signal to rising edge of ODCK	1 pixel/clock, PIXS = low, OCK_INV = high	0.5			ns
		2 pixel and STAG, PIXS = high, STAG = low, OCK_INV = high	2.4			
		2 pixel/clock, PIXS = high, STAG = high, OCK_INV = high	2.1			
$f_{ODCK}$	ODCK frequency	PIX = low (1-PIX/CLK)	25		165	MHz
		PIX = high (2-PIX/CLK)	12.5		82.5	
	ODCK duty-cycle		40%	50%	60%	
$t_{pd(PDL)}$	Propagation delay time from $\overline{PD}$ low to Hi-Z outputs				9	ns
$t_{pd(PDOL)}$	Propagation delay time from $\overline{PDO}$ low to Hi-Z outputs				9	ns
$t_{t(HSC)}$	Transition time between DE transition to SCDT low <sup>(8)</sup>			1e6		$t_{pix}$
$t_{t(FSC)}$	Transition time between DE transition to SCDT high <sup>(8)</sup>			1600		$t_{pix}$
$t_{d(st)}$	Delay time, ODCK latching edge to QE[23:0] data output	$\overline{STAG}$ = low, PIXS = high		0.25		$t_{pix}$

(8) Link active or inactive is determined by amount of time detected between DE transitions. SCDT indicates link activity.

### 2.3.2 Parameter Measurement Information

#### PARAMETER MEASUREMENT INFORMATION

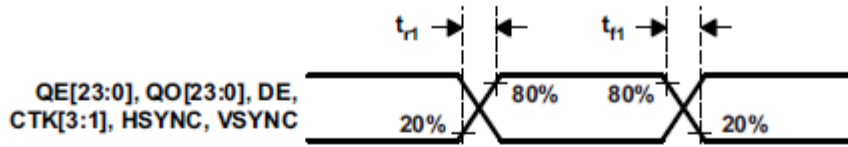

Figure 1. Rise and Fall Times of Data and Control Signals

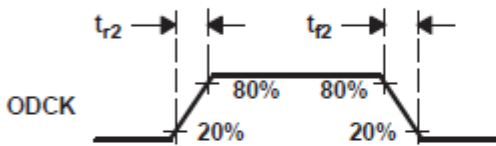

Figure 2. Rise and Fall Times of ODCK

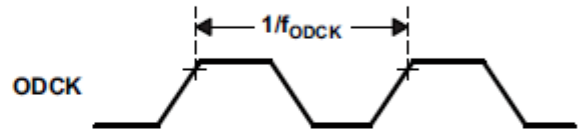

Figure 3. ODCK Frequency

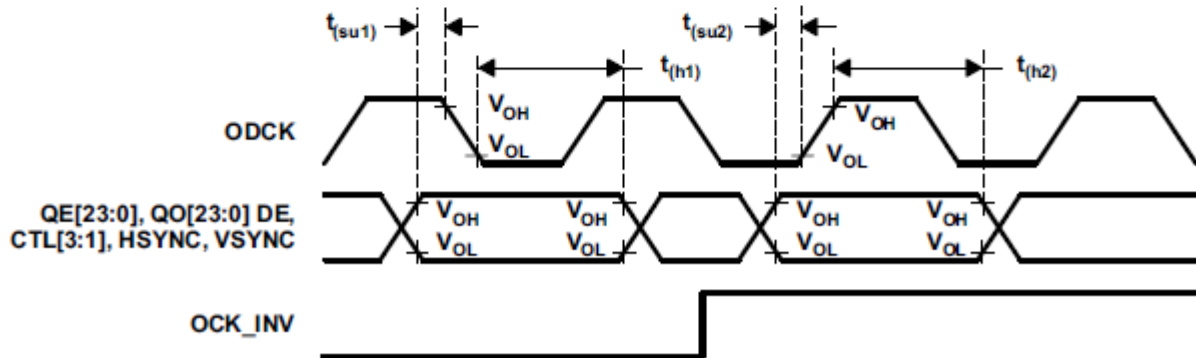

Figure 4. Data Setup and Hold Times to Rising and Falling Edges of ODCK

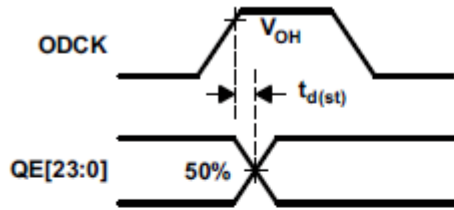

Figure 5. ODCK High to QE[23:0] Staggered Data Output

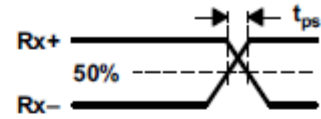

Figure 6. Analog Input Intra-Pair Differential Skew

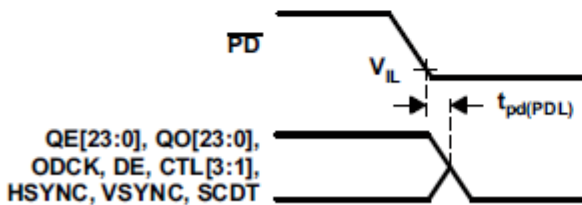

Figure 7. Delay From  $\overline{PD}$  Low to Hi-Z Outputs

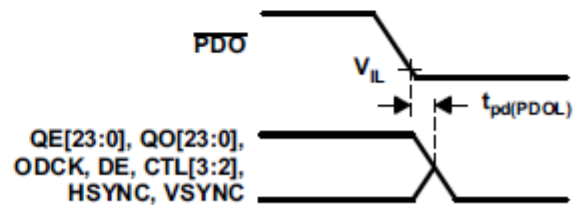

Figure 8. Delay From  $\overline{PDO}$  Low to Hi-Z Outputs

### PARAMETER MEASUREMENT INFORMATION (continued)

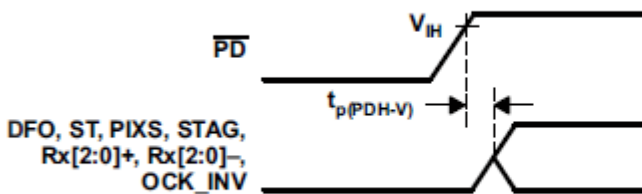

Figure 9. Delay From  $\overline{PD}$  Low to High Before Inputs Are Active

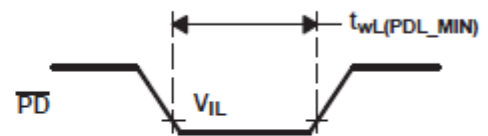

Figure 10. Minimum Time  $\overline{PD}$  Low

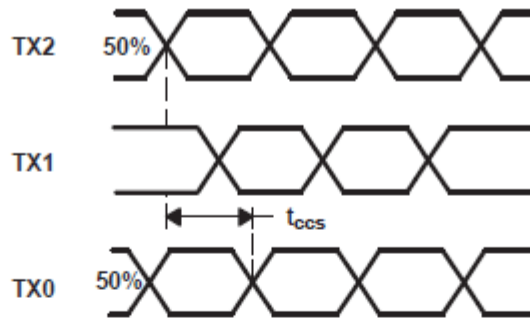

Figure 11. Analog Input Channel-to-Channel Skew

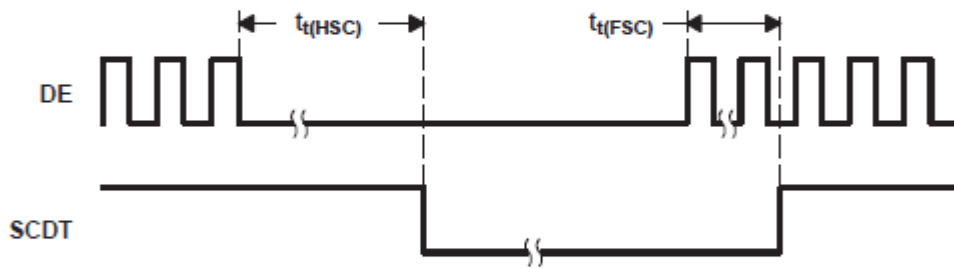

Figure 12. Time Between DE Transitions to SCDT Low and SCDT High

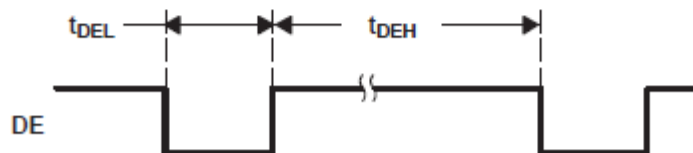
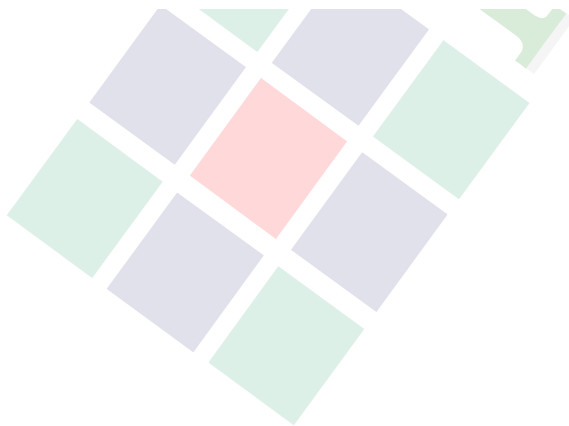

Figure 13. Minimum DE Low and Maximum DE High

### DETAILED DESCRIPTION





### 3. QUALITY ASSURANCE SYSTEM

#### 3.1 Quality Assurance Flow Chart

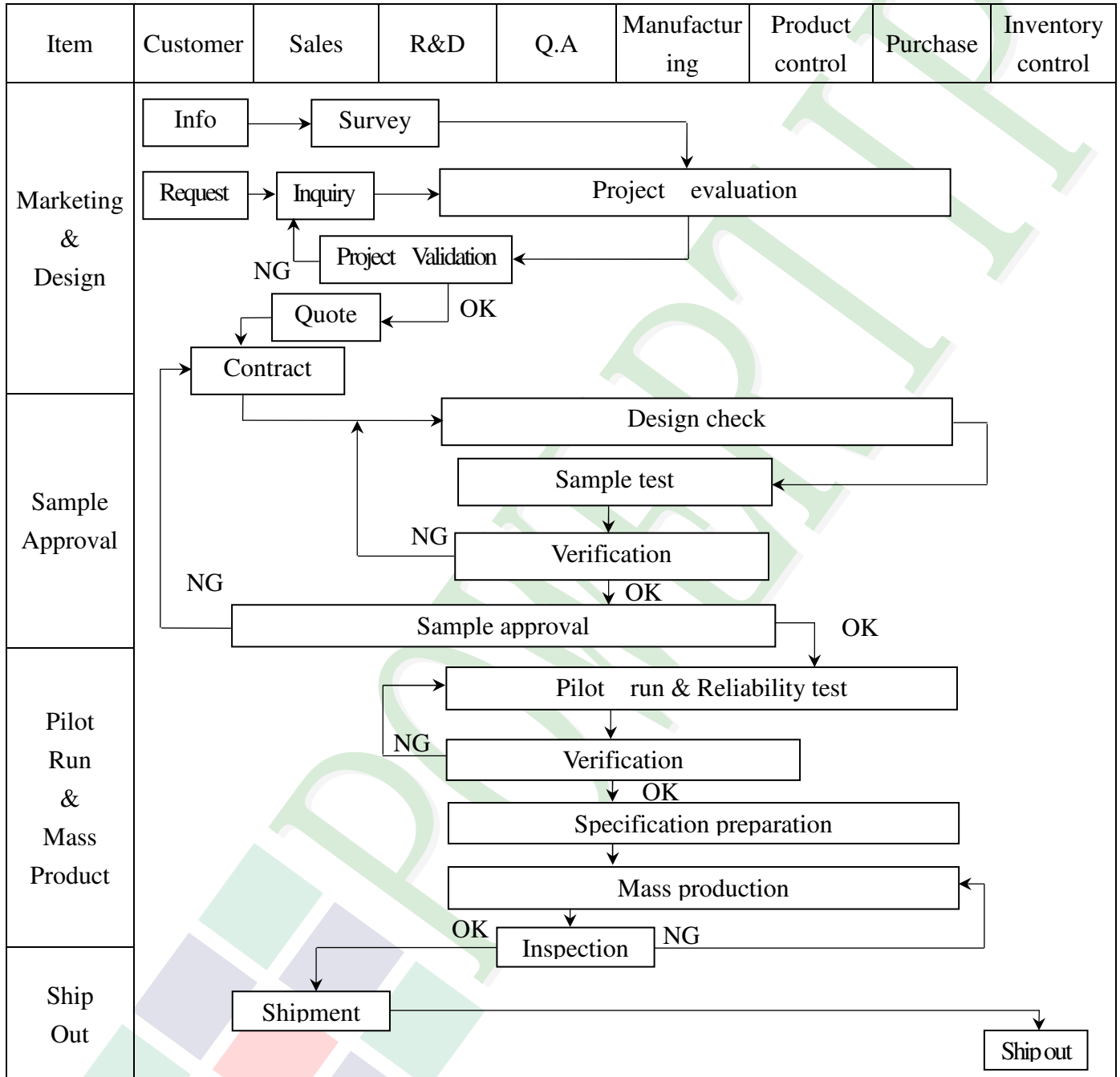

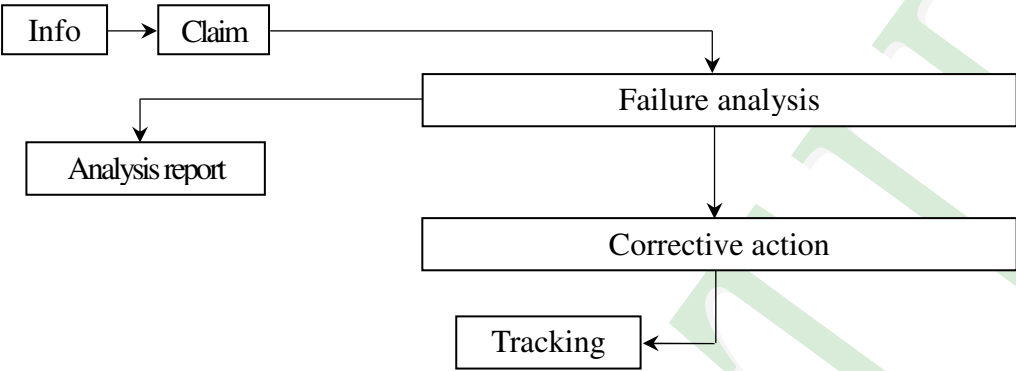
Item	Customer	Sales	R&D	Q.A	Manufacturing	Product control	Purchase	Inventory control
Sales Service	 <pre> graph TD     Info[Info] --&gt; Claim[Claim]     Claim --&gt; Failure[Failure analysis]     Failure --&gt; Report[Analysis report]     Failure --&gt; Action[Corrective action]     Action --&gt; Tracking[Tracking]           </pre>							
Q.A Activity	1. ISO 9001 Maintenance Activities 3. Equipment calibration 5. Standardization Management				2. Process improvement proposal 4. Education And Training Activities			

### 3.2. Inspection Specification

◆Scope : The document shall be applied to TFT-LCD Module for 3.5" ~15" (Ver.B01).

◆Inspection Standard : MIL-STD-105E Table Normal Inspection Single Sampling Level II.

◆Equipment : Gauge 、 MIL-STD 、 Powertip Tester 、 Sample

◆Defect Level : Major Defect AQL : 0.4 ; Minor Defect AQL : 1.5

◆OUT Going Defect Level : Sampling.

◆Standard of the product appearance test :

a. Manner of appearance test :

(1). The test best be under 20W×2 fluorescent light , and distance of view must be at 30 cm.

(2). The test direction is base on about around 45° of vertical line.

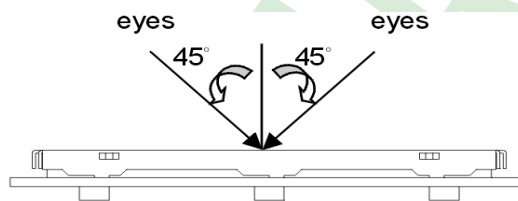

(3). Definition of area.

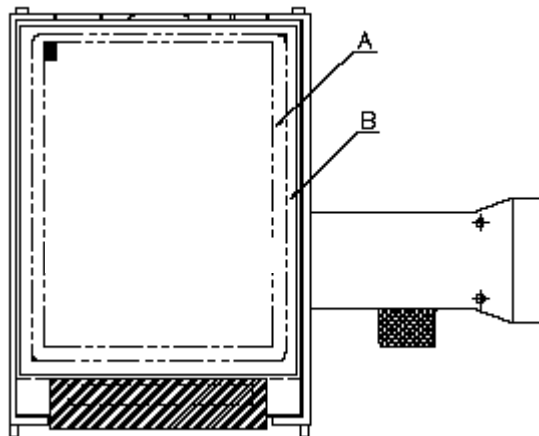

**A** area : viewing area

**B** area : Outside of viewing area

(4). Standard of inspection : (Unit : mm)

◆Specification For TFT-LCD Module 3.5" ~15" :

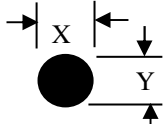
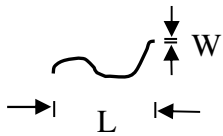

(Ver.B01)

NO	Item	Criterion	Level												
01	Product condition	1. 1The part number is inconsistent with work order of production.	Major												
		1. 2 Mixed product types.	Major												
		1. 3 Assembled in inverse direction.	Major												
02	Quantity	2. 1The quantity is inconsistent with work order of production.	Major												
03	Outline dimension	3. 1 Product dimension and structure must conform to structure diagram.	Major												
04	Electrical Testing	4. 1 Missing line character and icon.	Major												
		4. 2 No function or no display.	Major												
		4. 3 Display malfunction.	Major												
		4. 4 LCD viewing angle defect.	Major												
		4. 5 Current consumption exceeds product specifications.	Major												
		4. 6 Mura can not be seen through 5% ND filter. (Mura : Under the normal examination angle of view,the picture has the non-uniform phenomenon.)	Minor												
05	Dot defect (Bright dot 、 Dark dot)  On -display	<table border="1"> <thead> <tr> <th></th> <th>Item</th> <th>Acceptance (Q'ty)</th> </tr> </thead> <tbody> <tr> <td rowspan="4">Dot Defect</td> <td>Bright Dot</td> <td><math>\leq 4</math></td> </tr> <tr> <td>Dark Dot</td> <td><math>\leq 5</math></td> </tr> <tr> <td>Joint Dot</td> <td><math>\leq 3</math></td> </tr> <tr> <td>Total</td> <td><math>\leq 7</math></td> </tr> </tbody> </table>		Item	Acceptance (Q'ty)	Dot Defect	Bright Dot	$\leq 4$	Dark Dot	$\leq 5$	Joint Dot	$\leq 3$	Total	$\leq 7$	Minor
			Item	Acceptance (Q'ty)											
Dot Defect	Bright Dot	$\leq 4$													
	Dark Dot	$\leq 5$													
	Joint Dot	$\leq 3$													
	Total	$\leq 7$													
<p>5. 1 Inspection pattern : full white , full black , Red , Green and blue screens.</p> <p>5. 2 It is defined as dot defect if defect area <math>&gt; 1/2</math> dot.</p> <p>5. 3 The distance between two dot defect <math>\geq 5</math> mm.</p> <p>5. 4 Bright dot that can not be seen through 5% ND filter.</p>															

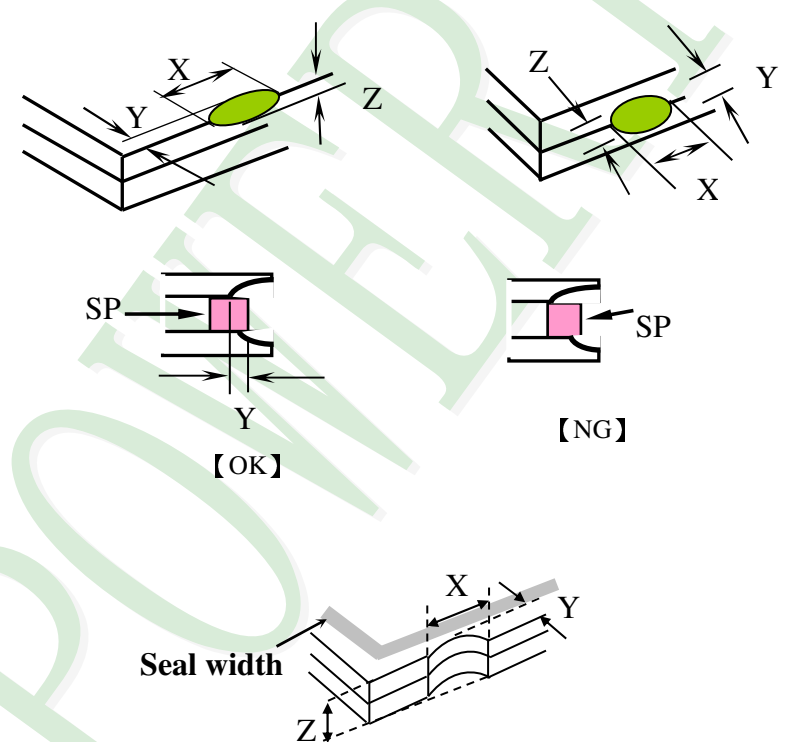
NO	Item	Criterion	Level																																																								
06	<p>Black or white dot、scratch、contamination</p> <p>Round type</p>  <p><math>\Phi = (x + y) / 2</math></p> <p>Line type</p> 	<p>6.1 Round type ( Non-display or display ) :</p> <table border="1" data-bbox="512 436 1289 712"> <thead> <tr> <th rowspan="2">Dimension (diameter : <math>\Phi</math>)</th> <th colspan="2">Acceptance (Q'ty)</th> </tr> <tr> <th>A area</th> <th>B area</th> </tr> </thead> <tbody> <tr> <td><math>\Phi \leq 0.25</math></td> <td colspan="2">Ignore</td> </tr> <tr> <td><math>0.25 &lt; \Phi \leq 0.50</math></td> <td>5</td> <td rowspan="3">Ignore</td> </tr> <tr> <td><math>\Phi &gt; 0.50</math></td> <td>0</td> </tr> <tr> <td><b>Total</b></td> <td>5</td> </tr> </tbody> </table> <p>6.2 Line type( Non-display or display ) :</p> <table border="1" data-bbox="434 831 1369 1370"> <thead> <tr> <th rowspan="2">module size</th> <th rowspan="2">Length (L)</th> <th rowspan="2">Width (W)</th> <th colspan="2">Acceptance (Q'ty)</th> </tr> <tr> <th>A area</th> <th>B area</th> </tr> </thead> <tbody> <tr> <td rowspan="4">3.5" to less 9"</td> <td>---</td> <td><math>W \leq 0.03</math></td> <td>Ignore</td> <td rowspan="4">Ignore</td> </tr> <tr> <td><math>L \leq 10.0</math></td> <td><math>0.03 &lt; W \leq 0.05</math></td> <td>4</td> </tr> <tr> <td><math>L \leq 5.0</math></td> <td><math>0.05 &lt; W \leq 0.10</math></td> <td>2</td> </tr> <tr> <td>---</td> <td><math>W &gt; 0.10</math></td> <td>As round type</td> </tr> <tr> <td colspan="3"><b>Total</b></td> <td>5</td> <td></td> </tr> <tr> <td rowspan="4">9" to 15"</td> <td>---</td> <td><math>W \leq 0.05</math></td> <td>Ignore</td> <td rowspan="4">Ignore</td> </tr> <tr> <td><math>L \leq 10.0</math></td> <td><math>0.05 &lt; W \leq 0.10</math></td> <td>5</td> </tr> <tr> <td>---</td> <td><math>W &gt; 0.10</math></td> <td>As round type</td> </tr> <tr> <td colspan="3"><b>Total</b></td> <td>5</td> </tr> </tbody> </table>	Dimension (diameter : $\Phi$ )	Acceptance (Q'ty)		A area	B area	$\Phi \leq 0.25$	Ignore		$0.25 < \Phi \leq 0.50$	5	Ignore	$\Phi > 0.50$	0	<b>Total</b>	5	module size	Length (L)	Width (W)	Acceptance (Q'ty)		A area	B area	3.5" to less 9"	---	$W \leq 0.03$	Ignore	Ignore	$L \leq 10.0$	$0.03 < W \leq 0.05$	4	$L \leq 5.0$	$0.05 < W \leq 0.10$	2	---	$W > 0.10$	As round type	<b>Total</b>			5		9" to 15"	---	$W \leq 0.05$	Ignore	Ignore	$L \leq 10.0$	$0.05 < W \leq 0.10$	5	---	$W > 0.10$	As round type	<b>Total</b>			5	Minor
Dimension (diameter : $\Phi$ )	Acceptance (Q'ty)																																																										
	A area	B area																																																									
$\Phi \leq 0.25$	Ignore																																																										
$0.25 < \Phi \leq 0.50$	5	Ignore																																																									
$\Phi > 0.50$	0																																																										
<b>Total</b>	5																																																										
module size	Length (L)	Width (W)	Acceptance (Q'ty)																																																								
			A area	B area																																																							
3.5" to less 9"	---	$W \leq 0.03$	Ignore	Ignore																																																							
	$L \leq 10.0$	$0.03 < W \leq 0.05$	4																																																								
	$L \leq 5.0$	$0.05 < W \leq 0.10$	2																																																								
	---	$W > 0.10$	As round type																																																								
<b>Total</b>			5																																																								
9" to 15"	---	$W \leq 0.05$	Ignore	Ignore																																																							
	$L \leq 10.0$	$0.05 < W \leq 0.10$	5																																																								
	---	$W > 0.10$	As round type																																																								
	<b>Total</b>				5																																																						
07	Polarizer Bubble	<table border="1" data-bbox="478 1512 1326 1933"> <thead> <tr> <th rowspan="2">Dimension (diameter : <math>\Phi</math>)</th> <th colspan="2">Acceptance (Q'ty)</th> </tr> <tr> <th>A area</th> <th>B area</th> </tr> </thead> <tbody> <tr> <td><math>\Phi \leq 0.25</math></td> <td colspan="2">Ignore</td> </tr> <tr> <td><math>0.25 &lt; \Phi \leq 0.50</math></td> <td>4</td> <td rowspan="3">Ignore</td> </tr> <tr> <td><math>0.50 &lt; \Phi \leq 0.80</math></td> <td>1</td> </tr> <tr> <td><math>\Phi &gt; 0.80</math></td> <td>0</td> </tr> <tr> <td><b>Total</b></td> <td>5</td> <td></td> </tr> </tbody> </table>	Dimension (diameter : $\Phi$ )	Acceptance (Q'ty)		A area	B area	$\Phi \leq 0.25$	Ignore		$0.25 < \Phi \leq 0.50$	4	Ignore	$0.50 < \Phi \leq 0.80$	1	$\Phi > 0.80$	0	<b>Total</b>	5		Minor																																						
Dimension (diameter : $\Phi$ )	Acceptance (Q'ty)																																																										
	A area	B area																																																									
$\Phi \leq 0.25$	Ignore																																																										
$0.25 < \Phi \leq 0.50$	4	Ignore																																																									
$0.50 < \Phi \leq 0.80$	1																																																										
$\Phi > 0.80$	0																																																										
<b>Total</b>	5																																																										

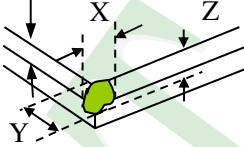
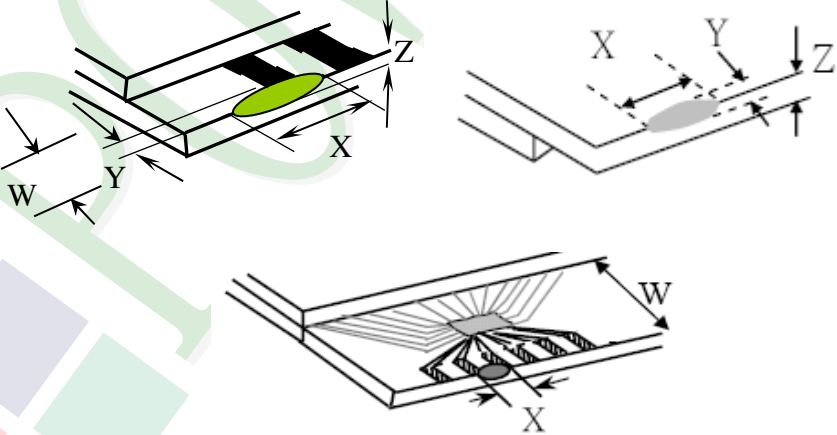
NO	Item	Criterion	Level						
08	The crack of glass	<p>Symbols :</p> <p>X : The length of crack                      Z : The thickness of crack                      t : The thickness of glass</p> <p>Y : The width of crack.                      W : terminal length                      a : LCD side length</p>	Minor						
		<p>8.1 General glass chip :</p> <p>8.1.1 Chip on panel surface and crack between panels:</p>  <table border="1" data-bbox="539 1585 1353 1881"> <thead> <tr> <th>X</th> <th>Y</th> <th>Z</th> </tr> </thead> <tbody> <tr> <td><math>\leq a</math></td> <td>Crack can't enter viewing area</td> <td><math>\leq 1/2 t</math></td> </tr> <tr> <td><math>\leq a</math></td> <td>Crack can't exceed the half of SP width.</td> <td><math>1/2 t &lt; Z \leq 2 t</math></td> </tr> </tbody> </table>		X	Y	Z	$\leq a$	Crack can't enter viewing area	$\leq 1/2 t$
X	Y	Z							
$\leq a$	Crack can't enter viewing area	$\leq 1/2 t$							
$\leq a$	Crack can't exceed the half of SP width.	$1/2 t < Z \leq 2 t$							

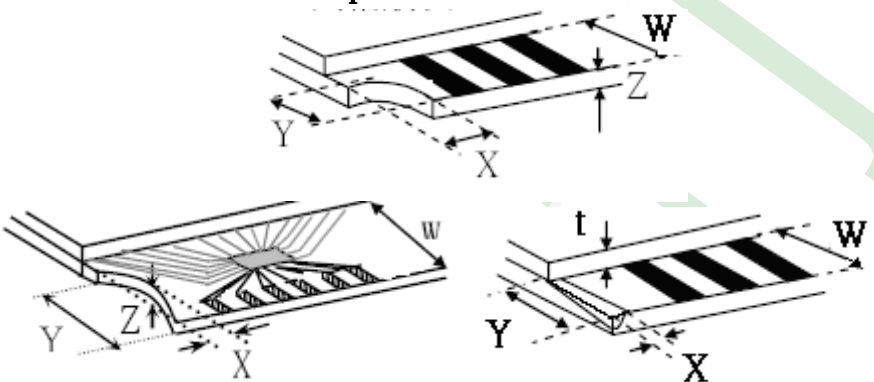
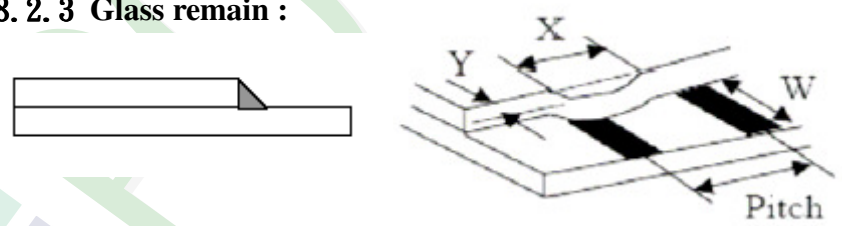
NO	Item	Criterion	Level										
08	The crack of glass	<p>Symbols :</p> <p>X : The length of crack Z : The thickness of crack t : The thickness of glass</p> <p>Y : The width of crack. W : terminal length a : LCD side length</p> <hr/> <p>8.1.2 Corner crack :</p>  <table border="1" data-bbox="520 779 1337 1070"> <thead> <tr> <th>X</th> <th>Y</th> <th>Z</th> </tr> </thead> <tbody> <tr> <td><math>\leq 1/5 a</math></td> <td>Crack can't enter viewing area</td> <td><math>Z \leq 1/2 t</math></td> </tr> <tr> <td><math>\leq 1/5 a</math></td> <td>Crack can't exceed the half of SP width.</td> <td><math>1/2 t &lt; Z \leq 2 t</math></td> </tr> </tbody> </table>	X	Y	Z	$\leq 1/5 a$	Crack can't enter viewing area	$Z \leq 1/2 t$	$\leq 1/5 a$	Crack can't exceed the half of SP width.	$1/2 t < Z \leq 2 t$		
		X	Y	Z									
$\leq 1/5 a$	Crack can't enter viewing area	$Z \leq 1/2 t$											
$\leq 1/5 a$	Crack can't exceed the half of SP width.	$1/2 t < Z \leq 2 t$											
<p>8.2 Protrusion over terminal :</p> <p>8.2.1 Chip on electrode pad :</p>  <table border="1" data-bbox="560 1711 1347 1883"> <thead> <tr> <th></th> <th>X</th> <th>Y</th> <th>Z</th> </tr> </thead> <tbody> <tr> <td>Front</td> <td><math>\leq a</math></td> <td><math>\leq 1/2 W</math></td> <td><math>\leq t</math></td> </tr> <tr> <td>Back</td> <td><math>\leq a</math></td> <td><math>\leq W</math></td> <td><math>\leq 1/2 t</math></td> </tr> </tbody> </table>		X	Y	Z	Front	$\leq a$	$\leq 1/2 W$	$\leq t$	Back	$\leq a$	$\leq W$	$\leq 1/2 t$	Minor
	X	Y	Z										
Front	$\leq a$	$\leq 1/2 W$	$\leq t$										
Back	$\leq a$	$\leq W$	$\leq 1/2 t$										

NO	Item	Criterion	Level												
08	The crack of glass	<p>Symbols :</p> <p><b>X</b> : The length of crack  <b>Z</b> : The thickness of crack  <b>t</b> : The thickness of glass</p> <p><b>Y</b> : The width of crack.  <b>W</b> : terminal length  <b>a</b> : LCD side length</p> <hr/> <p>8.2.2 Non-conductive portion :</p>  <table border="1" data-bbox="625 976 1257 1106"> <thead> <tr> <th>X</th> <th>Y</th> <th>Z</th> </tr> </thead> <tbody> <tr> <td><math>\leq 1/3 a</math></td> <td><math>\leq W</math></td> <td><math>\leq t</math></td> </tr> </tbody> </table> <p>⊙ If the chipped area touches the ITO terminal, over 2/3 of          ● the ITO must remain and be inspected according to electrode terminal specifications.</p> <p>8.2.3 Glass remain :</p>  <table border="1" data-bbox="545 1536 1241 1657"> <thead> <tr> <th>X</th> <th>Y</th> <th>Z</th> </tr> </thead> <tbody> <tr> <td><math>\leq a</math></td> <td><math>\leq 1/3 W</math></td> <td><math>\leq t</math></td> </tr> </tbody> </table> <p>8.2.4 Cracking</p>  <p style="text-align: center;"><b>Not Allowed</b></p>	X	Y	Z	$\leq 1/3 a$	$\leq W$	$\leq t$	X	Y	Z	$\leq a$	$\leq 1/3 W$	$\leq t$	Minor
		X	Y	Z											
		$\leq 1/3 a$	$\leq W$	$\leq t$											
		X	Y	Z											
$\leq a$	$\leq 1/3 W$	$\leq t$													



◆Specification For TFT-LCD Module 3.5" ~15" :

(Ver.B01)

NO	Item	Criterion	Level
09	Backlight elements	9. 1 Backlight can't work normally.	Major
		9. 2 Backlight doesn't light or color is wrong.	Major
		9. 3 Illumination source flickers when lit.	Major
10	General appearance	10. 1 Pin type 、 quantity 、 dimension must match type in structure diagram.	Major
		10. 2 No short circuits in components on PCB or FPC .	Major
		10. 3 Parts on PCB or FPC must be the same as on the production characteristic chart .There should be no wrong parts , missing parts or excess parts.	Major
		10. 4 Product packaging must the same as specified on packaging specification sheet.	Minor
		10. 5 The folding and peeled off in polarizer are not acceptable.	Minor
		10. 6 The PCB or FPC between B/L assembled distance(PCB or FPC ) is $\leq 1.5$ mm.	Minor



## 5. PRECAUTION RELATING PRODUCT HANDLING

### 5.1 SAFETY

- 5.1.1 If the LCD panel breaks , be careful not to get the liquid crystal to touch your skin.
- 5.1.2 If the liquid crystal touches your skin or clothes , please wash it off immediately by using soap and water.

### 5.2 HANDLING

- 5.2.1 Avoid any strong mechanical shock which can break the glass.
- 5.2.2 Avoid static electricity which can damage the CMOS LSI—When working with the module , be sure to ground your body and any electrical equipment you may be using.
- 5.2.3 Do not remove the panel or frame from the module.
- 5.2.4 The polarizing plate of the display is very fragile. So , please handle it very carefully ,do not touch , push or rub the exposed polarizing with anything harder than an HB pencil lead (glass , tweezers , etc.)
- 5.2.5 Do not wipe the polarizing plate with a dry cloth , as it may easily scratch the surface of plate.
- 5.2.6 Do not touch the display area with bare hands , this will stain the display area.
- 5.2.7 Do not use ketonics solvent & aromatic solvent. Use with a soft cloth soaked with a cleaning naphtha solvent.
- 5.2.8 To control temperature and time of soldering is  $320\pm 10^{\circ}\text{C}$  and 3-5 sec.
- 5.2.9 To avoid liquid (include organic solvent) stained on LCM .

### 5.3 STORAGE

- 5.3.1 Store the panel or module in a dark place where the temperature is  $25^{\circ}\text{C} \pm 5^{\circ}\text{C}$  and the humidity is below 65% RH.
- 5.3.2 Do not place the module near organics solvents or corrosive gases.
- 5.3.3 Do not crush , shake , or jolt the module.

### 5.4 TERMS OF WARRANTY

- 5.4.1 Applicable warrant period  
The period is within thirteen months since the date of shipping out under normal using and storage conditions.
- 5.4.2 Unaccepted responsibility  
This product has been manufactured to your company's specification as a part for use in your company's general electronic products. It is guaranteed to perform according to delivery specifications. For any other use apart from general electronic equipment , we cannot take responsibility if the product is used in nuclear power control equipment , aerospace equipment , fire and security systems or any other applications in which there is a direct risk to human life and where extremely high levels of reliability are required.

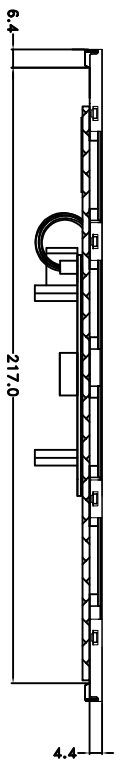
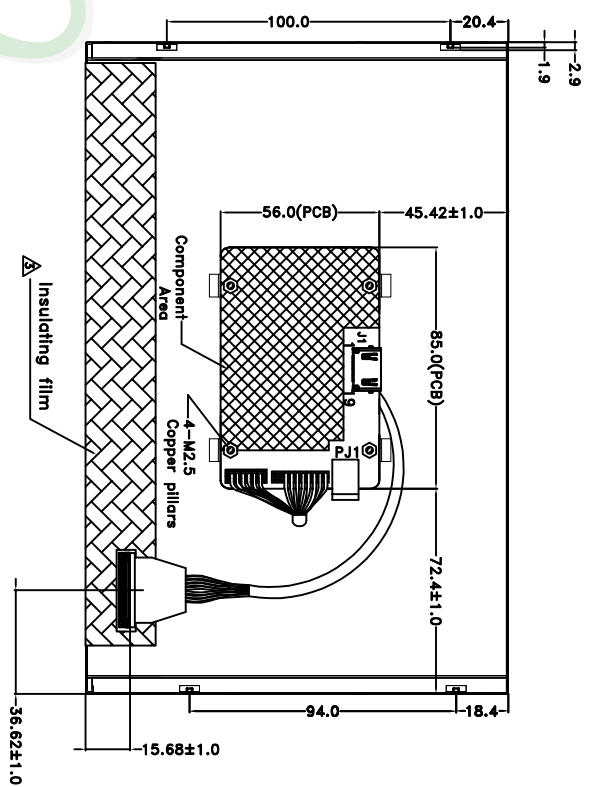
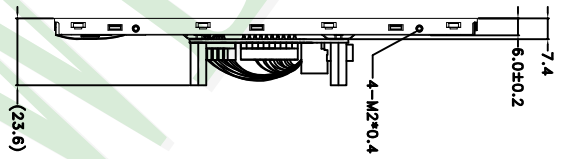
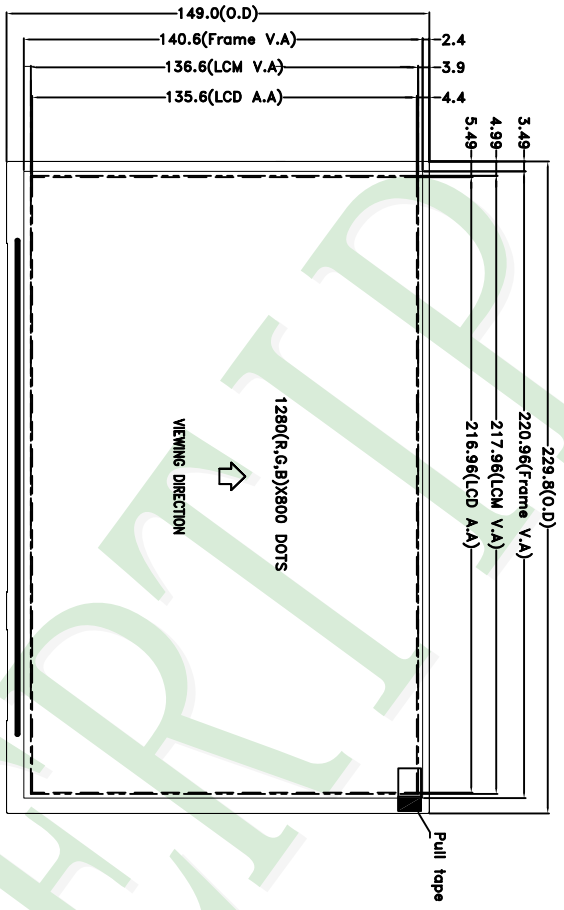

NOTES:  
1.LCD TYPE: TFT LCD  
2.LCD DISPLAY: POSITIVE/TRANSMISSIVE  
3.VIEW DIRECTION: 6 O'CLOCK  
4.The tolerance unless classified ±0.3mm  
5.Manufacturer/Type : Starconn/300E40-0010RA-G3  
6.Mating Receptacle/Type (Reference) : 118A0-1211TA-G3 OR EQUIVALENT.  
7.PJ1 :KD-014-(LDC JACK:2.0mm ROHS) OR EQUIVALENT.  
8.J1 :ETC-HMAR31610U019S-3440N-7RM4-GP OR EQUIVALENT.



久正光電股份有限公司  
POWER TIP TECHNOLOGY CORPORATION

007		PART NO:	PH128800T004-ZFA01		Design	Kevin	Surface		Precision Level
006		DRAWING NAME:	LMD-PH128800T004-ZFA01		Check	Stone	Material		
005		TITLE:	LCD MODULE DRAWING		Approve	Oliver	Thickness		
004	MODIFY DRAWING		2017/10/12				Quantity		
003	MODIFY DRAWING	Kevin	2017/04/18						
002	MODIFY DRAWING	Kevin	2017/04/13						
001	NEW DRAWING	Kevin							
REV	REV BY	REVISER	DATE						

# LCM包裝規格書

## LCM Packaging Specifications (For Tray)

Approve	Check	Contact
Oliver	Stone	Kevin

Documents NO. PKG-PH128800T004-ZFA01

### 1. 包裝材料規格表 (Packaging Material) : (per carton)

No.	Item	Model	Dimensions (mm)	1Pcs Weight	Quantity	Total Weight
1	成品 (LCD)	PH128800T004-ZFA01	229.8 X 149	0.2567	8	2.0536
2	多層薄膜(1)POF	OTFILM0BA03ABA	—————	———	4	———
3	TRAY 盤 (2)Tray	TY00000000425	352 X 260 X 35.8	0.15	12	1.8
4	內盒(3)Product Box	BX38327211AABA	383 X 270 X 110	0.25	4	1.0
5	保利龍板(4)Polylon board	OTPLB00PL08ABA	550 X 393 X 20	0.0284	2	0.0568
6	外紙箱(5)Carton	BX57041027CCBA	570 X 410 X 265	1.4208	1	1.4208
7	舒美墊(6)EPE	OTFOAMEP0001BA	333X 218 X 2.0	0.0032	4	0.0128
8	舒美墊(7)EPE	FOAM000000047	350 X 255 X 5	0.011	4	0.044
9						

2. 一整箱總重量 (Total LCD Weight in carton) : 6.40 Kg±10%

### 3. 單箱數量規格表 (Packaging Specifications and Quantity) :

(1)LCD quantity per box : no per tray	1	x no of tray	2	=	2
(2)Total LCD quantity in carton : quantity per box	2	x no of boxes	4	=	8

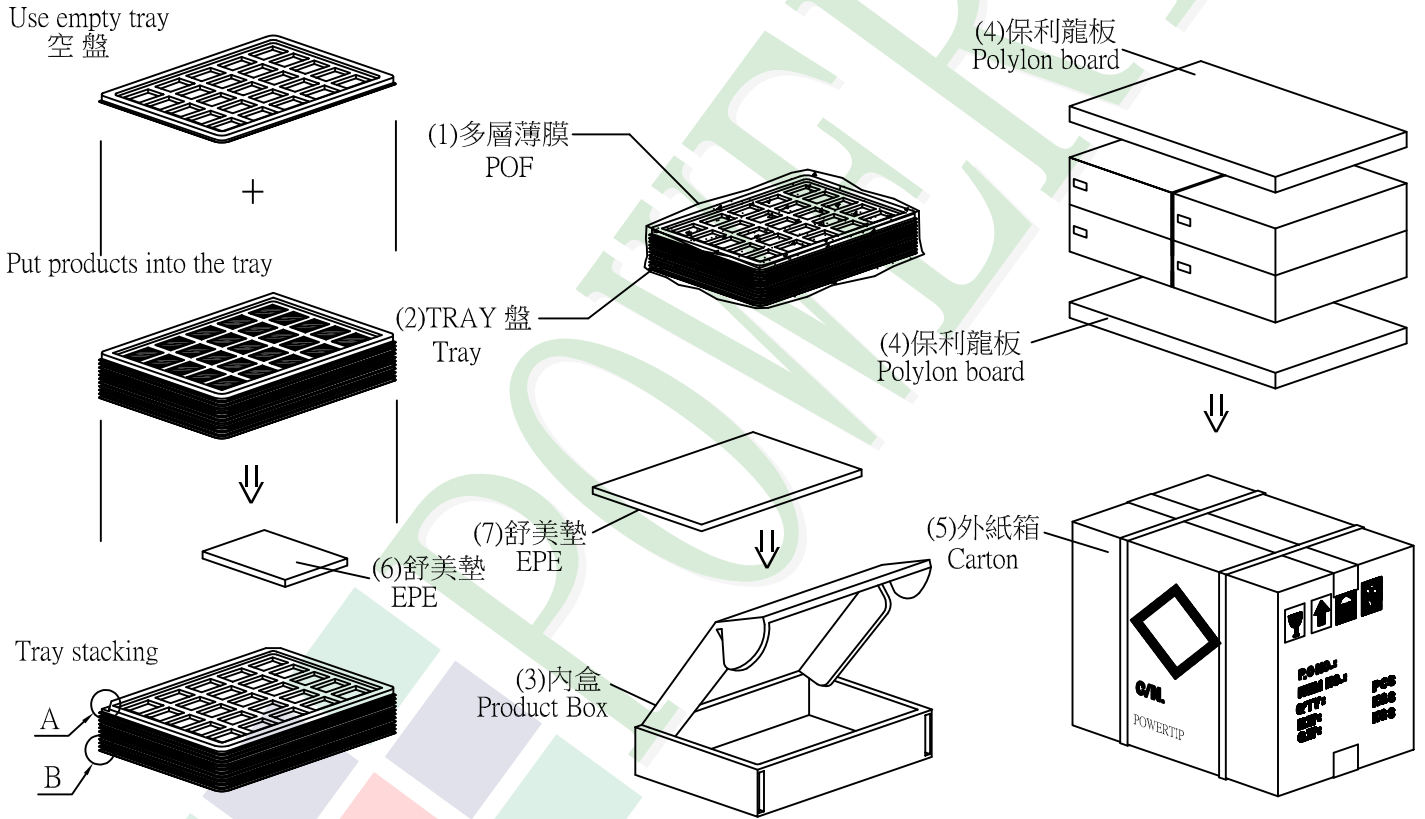

### 特 記 事 項 (REMARK)

4. TRAY盤相疊時,需旋轉180度,請詳見B視圖  
Rotate tray 180 degrees and place on top of stack.  
Check the tray stack using Fig. B.

5. LCM上面放置2.0t EPE(舒美墊)