

WR-51 Standard Gain Horn with 15 dBi gain, SMA Female connector

Technical Data Sheet

PEWAN051-15SF

Mechanical Specifications

Size

Length	3.199 in [81.25 mm]
Width	1.382 in [35.1 mm]
Height	0.994 in [25.25 mm]
Weight	0.173 lbs [78.47 g]

RF Connector

Type	SMA Female
------	------------

Waveguide Interface

Waveguide Size	WR-51
----------------	-------

Environmental Specifications

Compliance Certifications (see [product page](#) for current document)

Plotted and Other Data

Notes:

Click the following link (or enter part number in "SEARCH" on website) to obtain additional part information including price, inventory and certifications: [WR-51 Standard Gain Horn with 15 dBi gain, SMA Female connector PEWAN051-15SF](#)

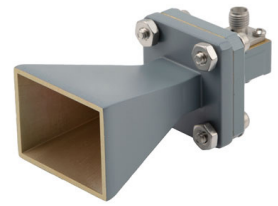

WR-51 Standard Gain Horn with 15 dBi gain, SMA Female connector

Technical Data Sheet

PEWAN051-15SF

Typical Performance Data

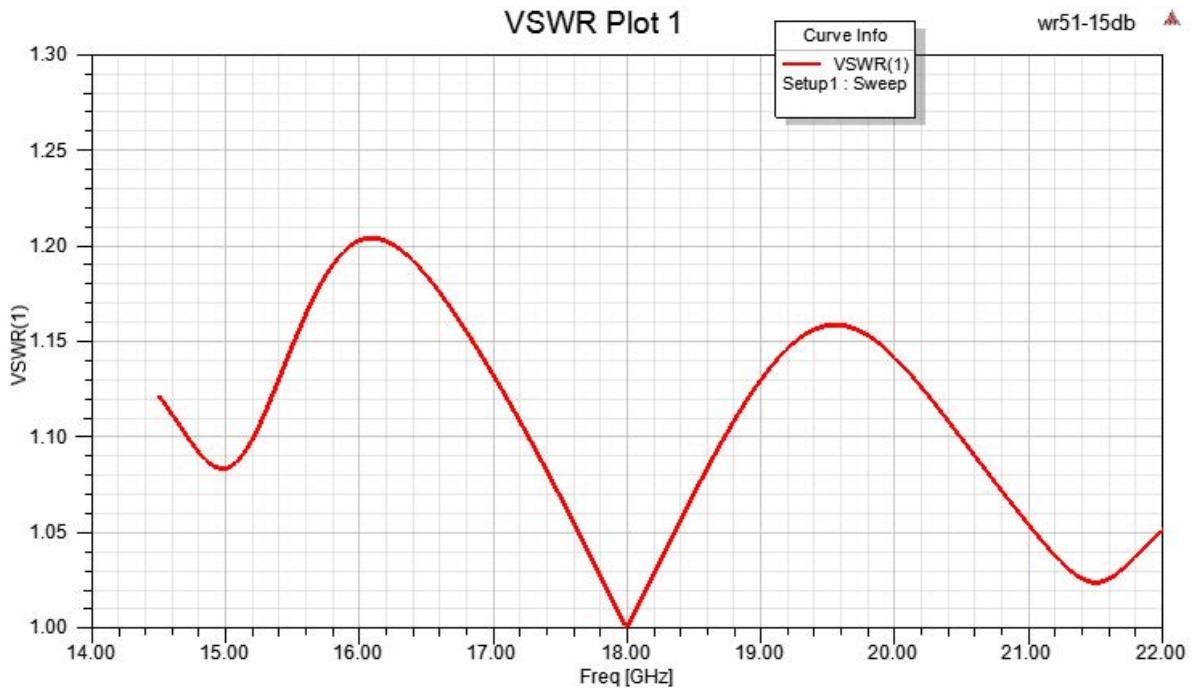

Click the following link (or enter part number in "SEARCH" on website) to obtain additional part information including price, inventory and certifications: [WR-51 Standard Gain Horn with 15 dBi gain, SMA Female connector PEWAN051-15SF](#)

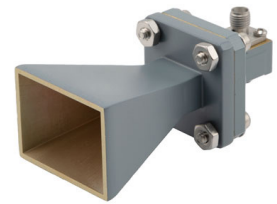

WR-51 Standard Gain Horn with 15 dBi gain, SMA Female connector

Technical Data Sheet

PEWAN051-15SF

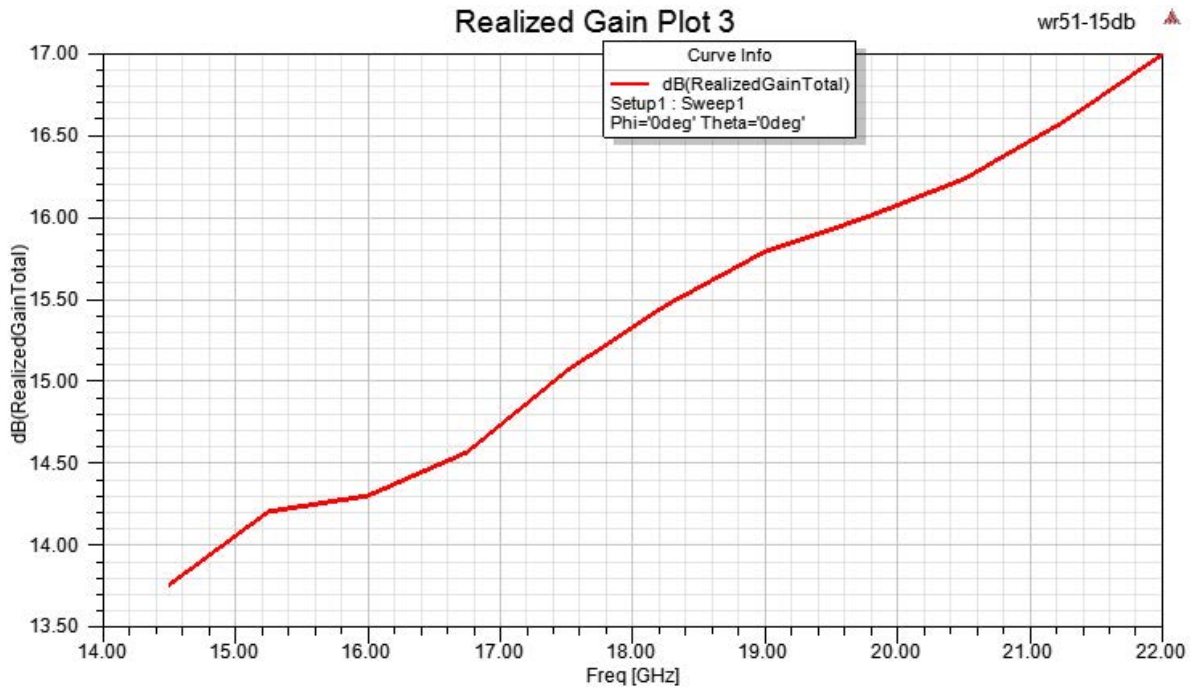

Click the following link (or enter part number in "SEARCH" on website) to obtain additional part information including price, inventory and certifications: [WR-51 Standard Gain Horn with 15 dBi gain, SMA Female connector PEWAN051-15SF](#)

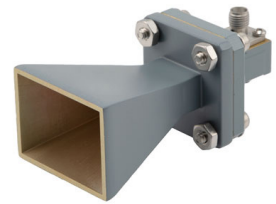

WR-51 Standard Gain Horn with 15 dBi gain, SMA Female connector

Technical Data Sheet

PEWAN051-15SF

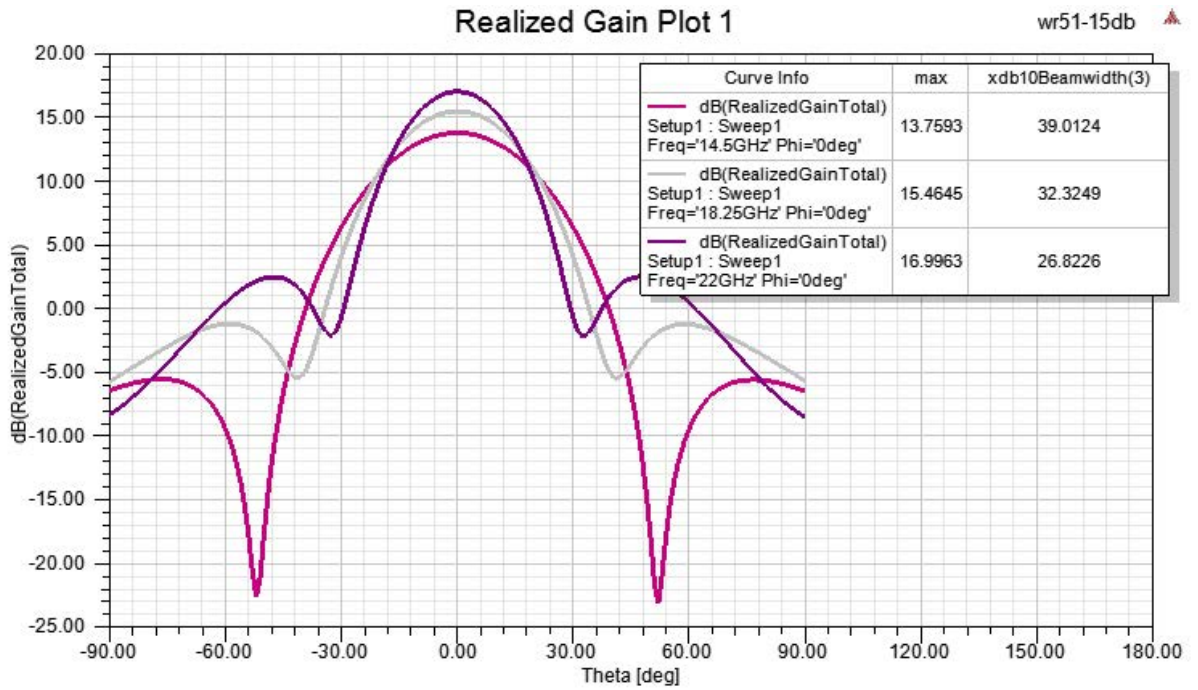

Click the following link (or enter part number in "SEARCH" on website) to obtain additional part information including price, inventory and certifications: [WR-51 Standard Gain Horn with 15 dBi gain, SMA Female connector PEWAN051-15SF](#)

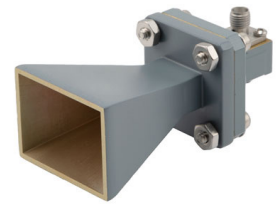

WR-51 Standard Gain Horn with 15 dBi gain, SMA Female connector

Technical Data Sheet

PEWAN051-15SF

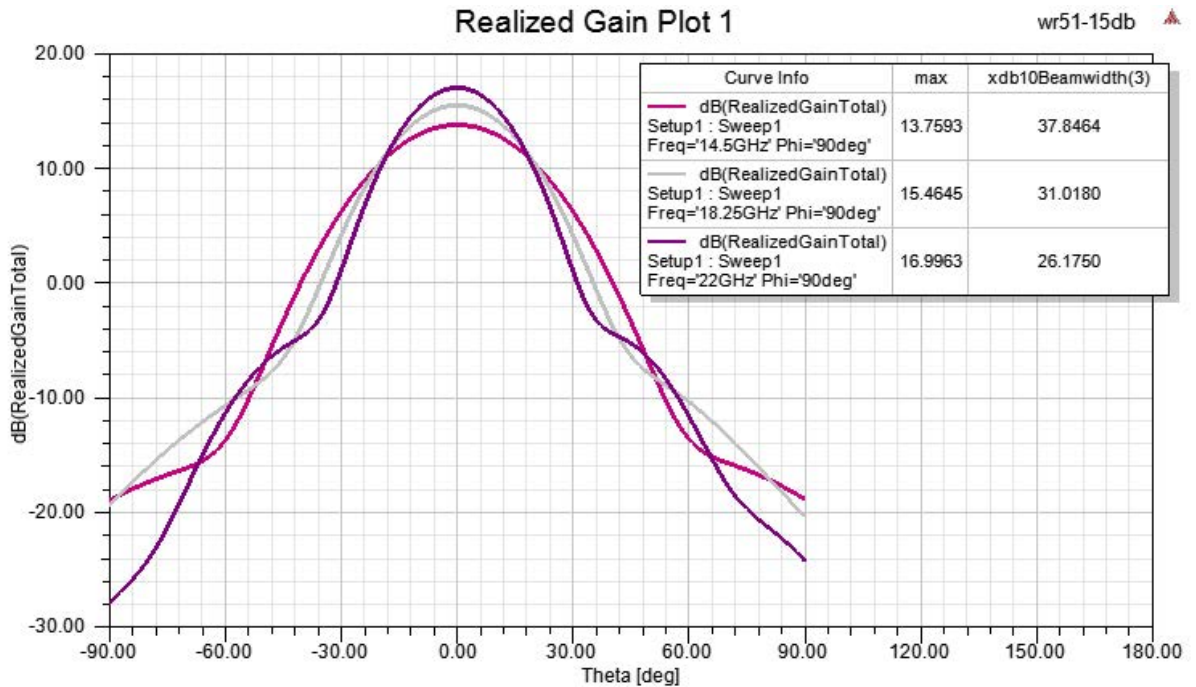

WR-51 Standard Gain Horn with 15 dBi gain, SMA Female connector from Pasternack Enterprises has same day shipment for domestic and International orders. Our RF, microwave and millimeter wave products maintain a 99.4% availability and are part of the broadest selection in the industry.

Click the following link (or enter part number in "SEARCH" on website) to obtain additional part information including price, inventory and certifications: [WR-51 Standard Gain Horn with 15 dBi gain, SMA Female connector PEWAN051-15SF](#)

URL:

The information contained in this document is accurate to the best of our knowledge and representative of the part described herein. It may be necessary to make modifications to the part and/or the documentation of the part, in order to implement improvements. Pasternack reserves the right to make such changes as required. Unless otherwise stated, all specifications are nominal. Pasternack does not make any representation or warranty regarding the suitability of the part described herein for any particular purpose, and Pasternack does not assume any liability arising out of the use of any part or documentation.

PEWAN051-15SF CAD Drawing

WR-51 Standard Gain Horn with 15 dB gain, SMA Female connector

REVISIONS			
REV.	DESCRIPTION	DATE	APPROVED
A	INITIAL RELEASE	10/04/2021	KHIETPAS

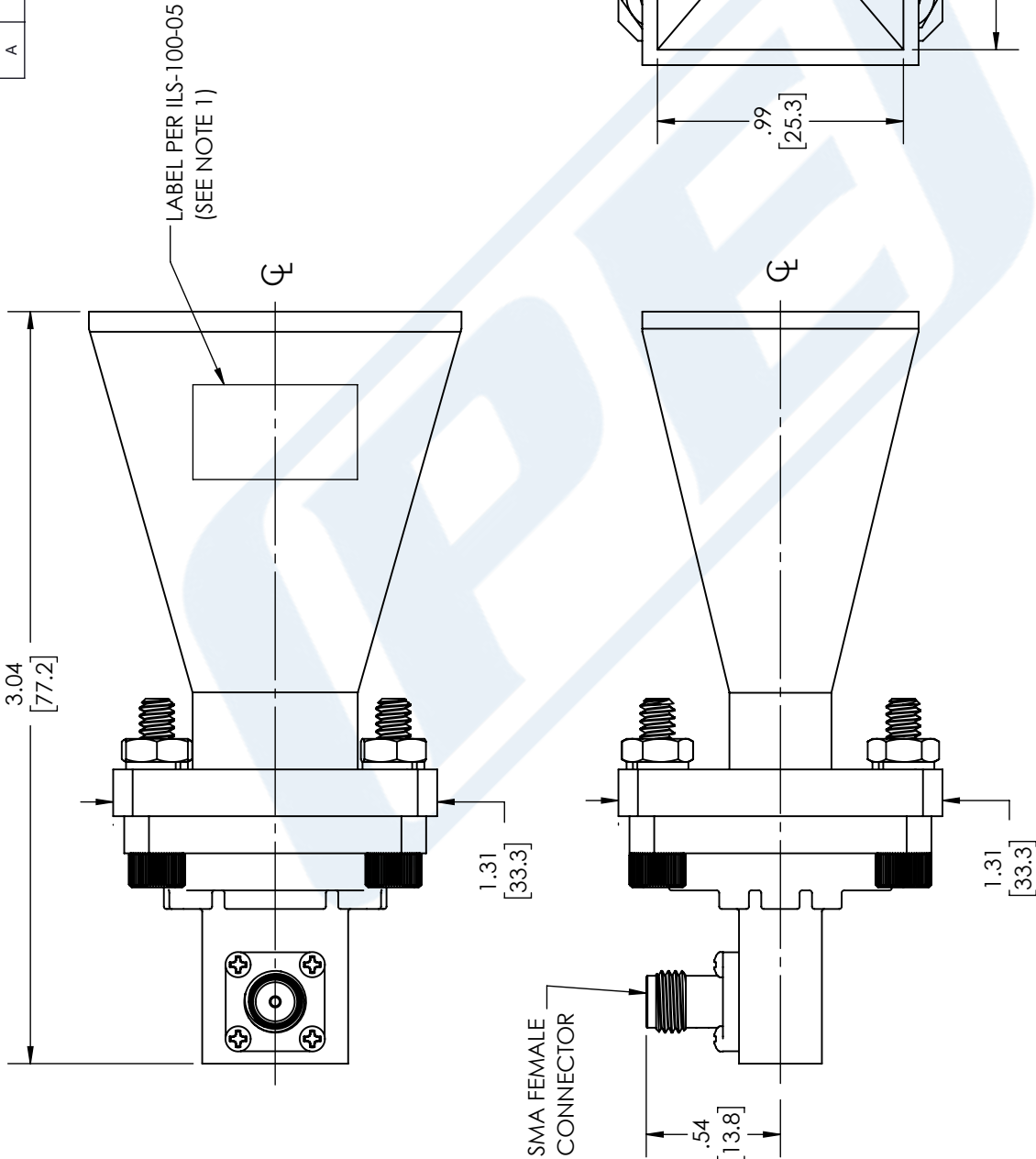

UNLESS OTHERWISE SPECIFIED LEADING DIMENSIONS ARE INCHES DIMENSIONS IN [] ARE MILLIMETERS

TOLERANCES:

.X = ±.2 [5.08] FRACTIONS ±1/32
 .XX = ±.02 [.51] ±.1/32
 .XXX = ±.005 [.13] ANGLES ± 1°

CABLE LENGTH (L), TOLERANCES:
 L ≤ 12 [305] = +1 [25] / -0
 12 [305] < L ≤ 60 [1524] = +2 [51] / -0
 60 [1524] < L ≤ 120 [3048] = +4 [102] / -0
 120 [3048] < L ≤ 300 [7620] = +6 [152] / -0
 300 [7620] < L = +5% / -0

ALL DIMENSIONS SHOWN ARE FOR REFERENCE ONLY.

THIRD-ANGLE PROJECTION

THE INFORMATION AND DESIGN IN THIS DOCUMENT IS THE PROPERTY OF PASTERNAK CORPORATION ALL RIGHTS RESERVED.

SHEET 1 OF 1

SCALE N/A

PE PASTERNAK
 an INFINIT brand

Pasternack Enterprises, Inc.
 P. O. Box 16759, Irvine, CA 92623.
 Phone: 1.949.261.1920 | 1.866.727.8376
 Fax: 1.949.261.7451
 Website: www.pasternack.com
 E-mail: sales@pasternack.com

ITEM NO. PEWAN051-15SF

SIZE A CAGE CODE 53919 DRAWN BY BPUCHASKI

NOTES:
 1. LABEL PER ILS-100-05 (FOR INTERNAL REFERENCE ONLY)
 LABEL LOCATION FOR REFERENCE ONLY

THESE COMMODITIES, TECHNOLOGY OR SOFTWARE WERE EXPORTED FROM THE UNITED STATES IN ACCORDANCE WITH THE EXPORT ADMINISTRATION REGULATIONS. DIVERSION CONTRARY TO U.S. LAW PROHIBITED.