

WR-42 Standard Gain Horn with 15 dBi gain,  
End Launch 2.92mm Female connector

## Technical Data Sheet

**PEWAN042-15ELKF**

### Features

- 18 GHz to 26.5 GHz
- WR-42 Waveguide Band
- 15 dBi Nominal Gain
- 2.92mm Female End Launch Connector

### Applications

- Antenna Measurements
- Wireless Communication
- Laboratory Use
- Microwave Radio Systems
- Radome Testing
- Automotive Antenna Test
- Solutions
- Radar Cross Section
- Satellite Antenna Testing

### Description

The PEWAN042-15ELKF standard gain horn antenna (also known as waveguide horn) from Pasternack is part of our comprehensive selection of waveguide antennas. This standard gain horn is mated with a WR-42 to 2.92mm Female End Launch waveguide to coaxial adapter and operates from 18 GHz to 26.5 GHz.

Our PEWAN042-15ELKF standard gain horn antenna has a nominal gain of 15 dBi with a Horizontal and Vertical HPBW (Half Power Beam Width) of 31 dB and 32 dB respectively. Pasternack's 2.92mm Female End Launch to WR-42 standard gain horns are available in 10, 15 and 20 dBi models with pyramidal shape and connectorized input.

Waveguide antennas, such as the PEWAN042-15ELKF are used in a wide variety of applications due to the high-power handling capability, low loss, high directivity, and near constant electrical performance. Our WR-42 waveguide antennas with 2.92mm Female End Launch interface is part of over 40,000 RF, microwave and millimeter wave components from Pasternack available worldwide and Ship same day.

### Configuration

Design: WR-42 Standard Gain Horn  
Coaxial Interface: 2.92mm Female

### Electrical Specifications

Description	Minimum	Typical	Maximum	Units
Frequency Range	18		26.5	GHz
<b>Waveguide Standard Gain Horn</b>				
Gain		15		dBi
Horizontal Half Power Beam Width		31		Degrees
Vertical Half Power Beam Width		32		Degrees
<b>Waveguide to Coaxial Adapter</b>				
Input VSWR			1.3:1	

Click the following link (or enter part number in "SEARCH" on website) to obtain additional part information including price, inventory and certifications: [WR-42 Standard Gain Horn with 15 dBi gain, End Launch 2.92mm Female connector PEWAN042-15ELKF](#)

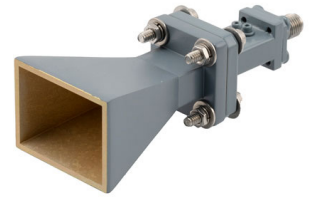

WR-42 Standard Gain Horn with 15 dBi gain,  
End Launch 2.92mm Female connector

## Technical Data Sheet

**PEWAN042-15ELKF**

### Mechanical Specifications

#### Size

Length	2.652 in [67.36 mm]
Width	1.258 in [31.95 mm]
Height	0.942 in [23.93 mm]
Weight	0.098 lbs [44.45 g]

#### RF Connector

Type	2.92mm Female
Specification	End Launch

#### Waveguide Interface

Waveguide Size	WR-42
----------------	-------

### Environmental Specifications

**Compliance Certifications** (see [product page](#) for current document)

### Plotted and Other Data

Notes:

Click the following link (or enter part number in "SEARCH" on website) to obtain additional part information including price, inventory and certifications: [WR-42 Standard Gain Horn with 15 dBi gain, End Launch 2.92mm Female connector PEWAN042-15ELKF](#)

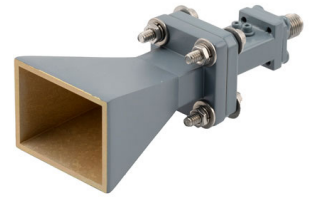

WR-42 Standard Gain Horn with 15 dBi gain,  
End Launch 2.92mm Female connector

**Technical Data Sheet**

**PEWAN042-15ELKF**

Typical Performance Data

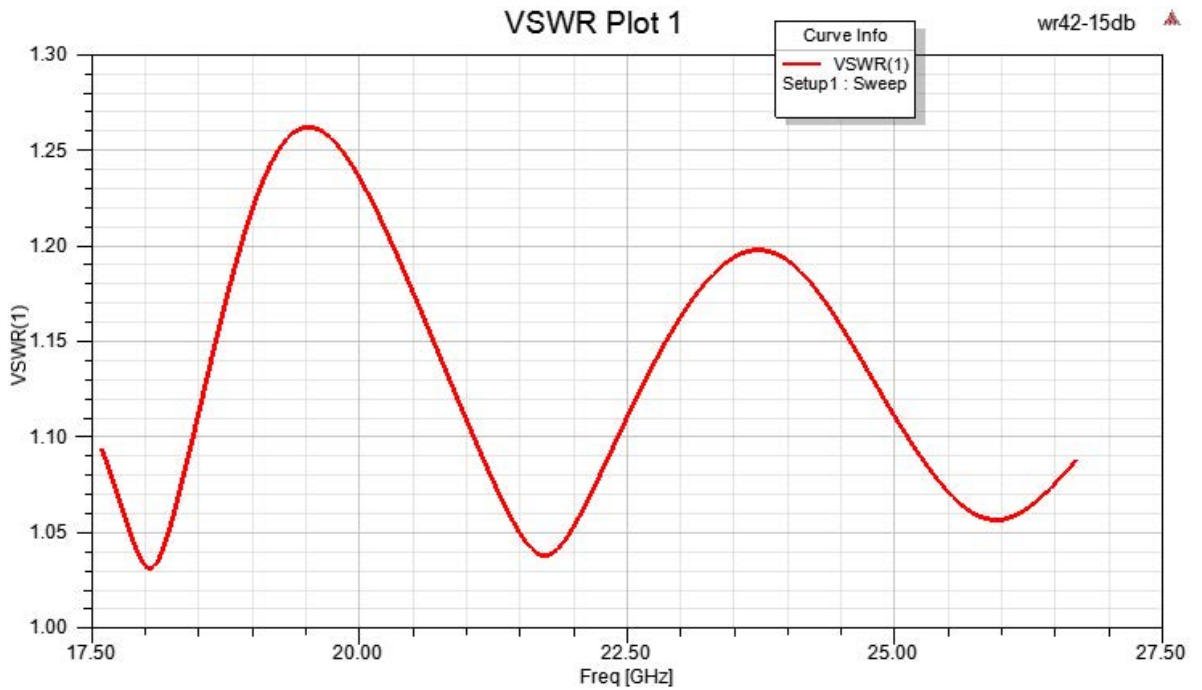

Click the following link (or enter part number in "SEARCH" on website) to obtain additional part information including price, inventory and certifications: [WR-42 Standard Gain Horn with 15 dBi gain, End Launch 2.92mm Female connector PEWAN042-15ELKF](#)

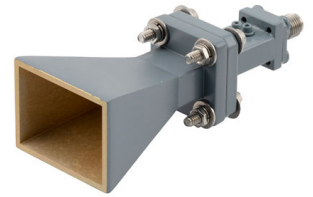

WR-42 Standard Gain Horn with 15 dBi gain,  
End Launch 2.92mm Female connector

**Technical Data Sheet**

**PEWAN042-15ELKF**

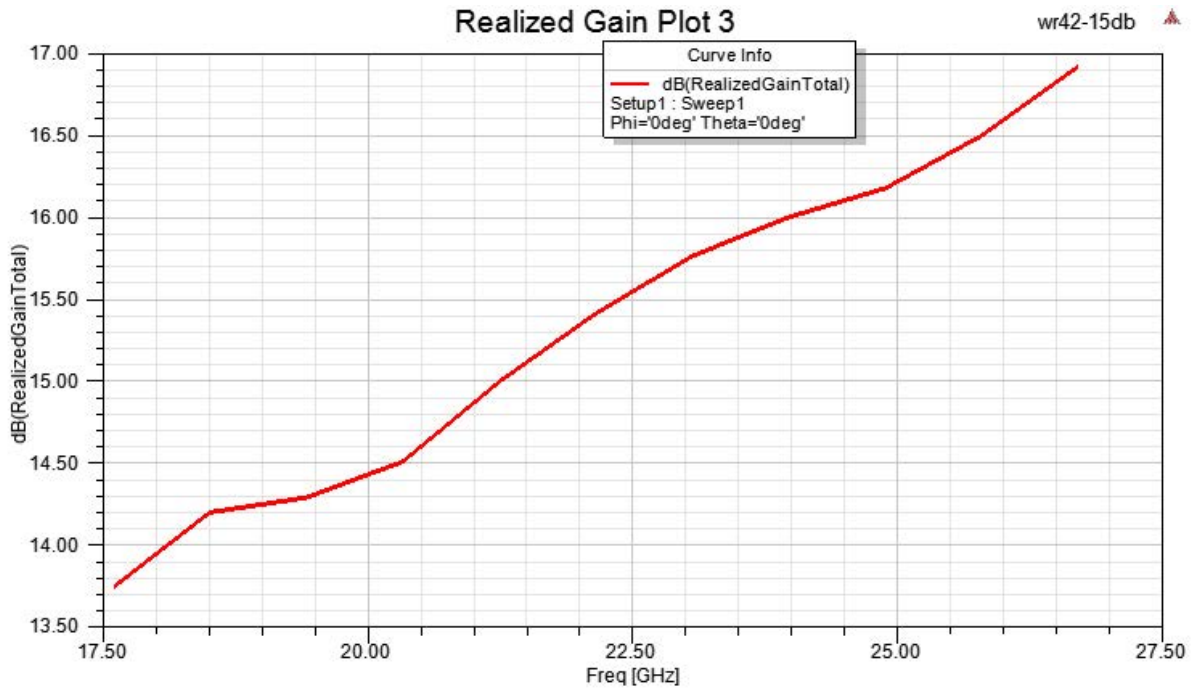

Click the following link (or enter part number in "SEARCH" on website) to obtain additional part information including price, inventory and certifications: [WR-42 Standard Gain Horn with 15 dBi gain, End Launch 2.92mm Female connector PEWAN042-15ELKF](#)

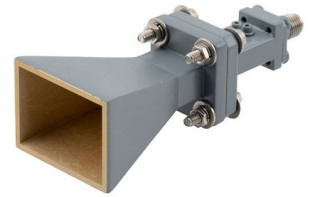

WR-42 Standard Gain Horn with 15 dBi gain,  
End Launch 2.92mm Female connector

**Technical Data Sheet**

**PEWAN042-15ELKF**

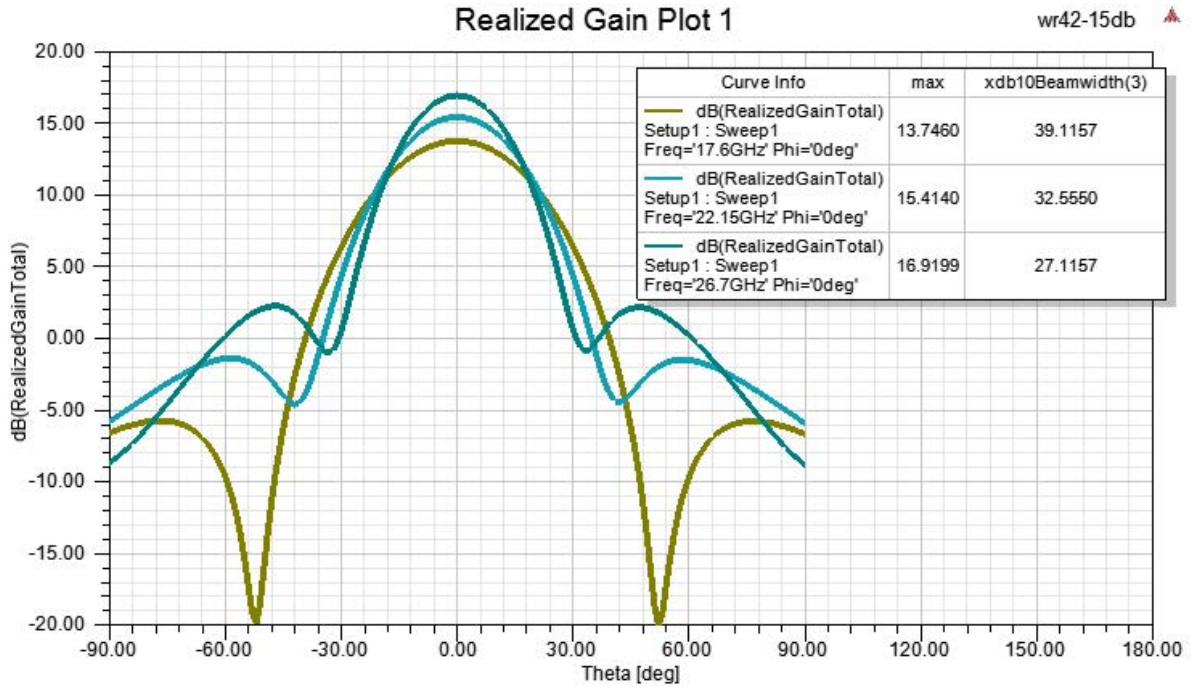

Click the following link (or enter part number in "SEARCH" on website) to obtain additional part information including price, inventory and certifications: [WR-42 Standard Gain Horn with 15 dBi gain, End Launch 2.92mm Female connector PEWAN042-15ELKF](#)

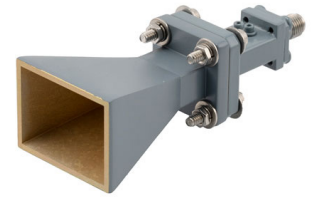

WR-42 Standard Gain Horn with 15 dBi gain,  
End Launch 2.92mm Female connector

**Technical Data Sheet**

**PEWAN042-15ELKF**

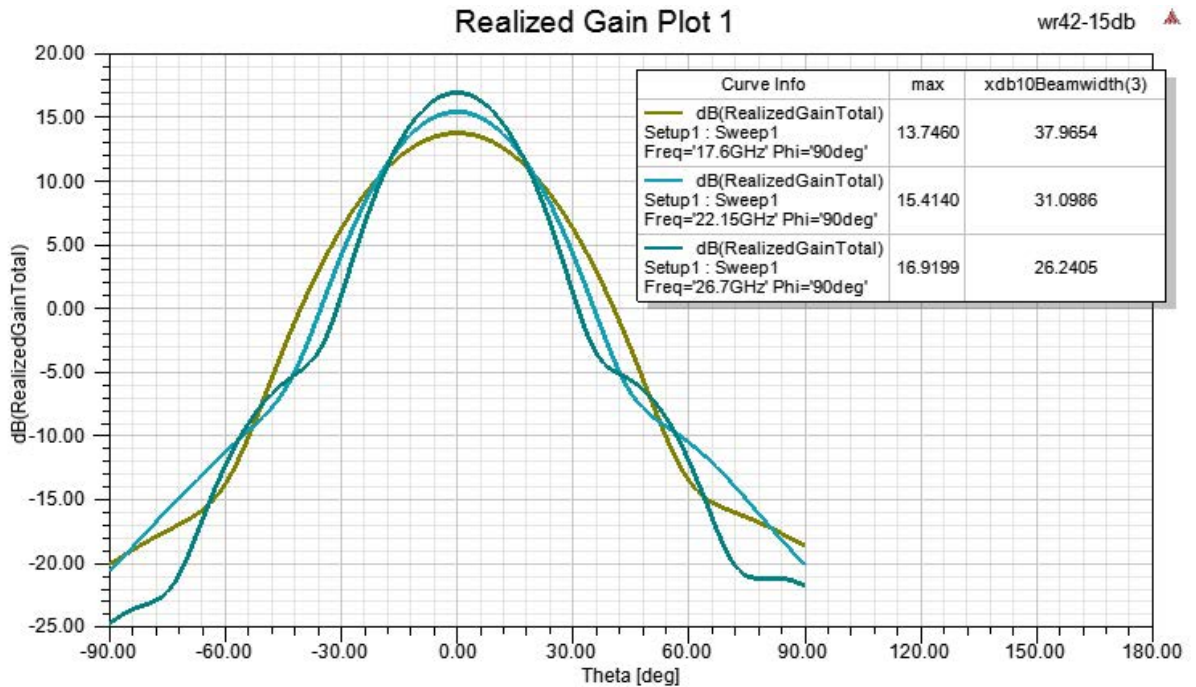

WR-42 Standard Gain Horn with 15 dBi gain, End Launch 2.92mm Female connector from Pasternack Enterprises has same day shipment for domestic and International orders. Our RF, microwave and millimeter wave products maintain a 99.4% availability and are part of the broadest selection in the industry.

Click the following link (or enter part number in "SEARCH" on website) to obtain additional part information including price, inventory and certifications: [WR-42 Standard Gain Horn with 15 dBi gain, End Launch 2.92mm Female connector PEWAN042-15ELKF](https://www.pasternack.com/wr-42-waveguide-standard-gain-horn-antenna-15-dbi-2.92mm-pewan042-15elkf-p.aspx)

URL: <https://www.pasternack.com/wr-42-waveguide-standard-gain-horn-antenna-15-dbi-2.92mm-pewan042-15elkf-p.aspx>

The information contained in this document is accurate to the best of our knowledge and representative of the part described herein. It may be necessary to make modifications to the part and/or the documentation of the part, in order to implement improvements. Pasternack reserves the right to make such changes as required. Unless otherwise stated, all specifications are nominal. Pasternack does not make any representation or warranty regarding the suitability of the part described herein for any particular purpose, and Pasternack does not assume any liability arising out of the use of any part or documentation.

# PEWAN042-15ELKF CAD Drawing

WR-42 Standard Gain Horn with 15 dBi gain, End Launch 2.92mm Female connector

REVISIONS		
REV.	DESCRIPTION	DATE
A	INITIAL RELEASE	10/04/2021
		APPROVED
		KHIETPAS

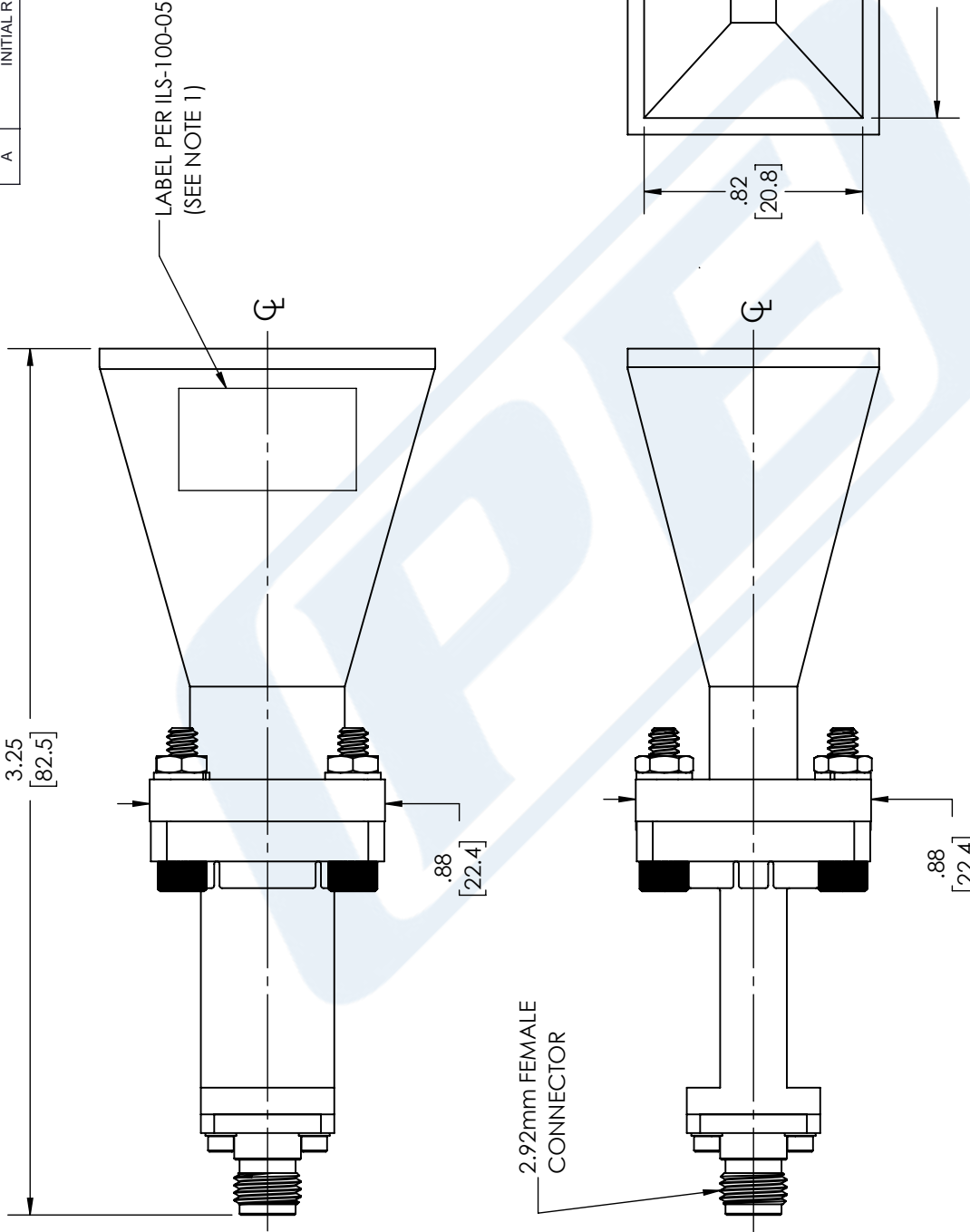

UNLESS OTHERWISE SPECIFIED LEADING DIMENSIONS ARE INCHES DIMENSIONS IN [ ] ARE MILLIMETERS

TOLERANCES:

.X = ±.2	[.008]	FRACTIONS	± 1/32
.XX = ±.02	[.51]	ANGLES ± 1°	
.XXX = ±.005	[.13]	CABLE LENGTH (L) TOLERANCES:	
		L ≤ 12 [305]	±.1 [25] / -0
		12 [305] < L ≤ 60 [1524]	±.2 [51] / -0
		60 [1524] < L ≤ 120 [3048]	±.4 [102] / -0
		120 [3048] < L ≤ 300 [7620]	±.6 [152] / -0
		300 [7620] < L	±.5% / -0

ALL DIMENSIONS SHOWN ARE FOR REFERENCE ONLY.

**PE PASTERNAK**  
an INFINIT brand

Pasternack Enterprises, Inc.  
P. O. Box 16759, Irvine, CA 92623.  
Phone: 1.949.261.1920 | 1.866.727.8376  
Fax: 1.949.261.7451  
Website: www.pasternack.com  
E-mail: sales@pasternack.com

THIRD-ANGLE PROJECTION

THE INFORMATION AND DESIGN IN THIS DOCUMENT IS THE PROPERTY OF PASTERNAK CORPORATION ALL RIGHTS RESERVED.

SHEET 1 OF 1

SCALE N/A

SIZE	CAGE CODE	DRAWN BY	ITEM NO.
A	53919	BPUCHASKI	PEWAN042-15ELKF
			REV A

**NOTES:**  
1. LABEL PER ILS-100-05 (FOR INTERNAL REFERENCE ONLY)  
LABEL LOCATION FOR REFERENCE ONLY

THESE COMMODITIES, TECHNOLOGY OR SOFTWARE WERE EXPORTED FROM THE UNITED STATES IN ACCORDANCE WITH THE EXPORT ADMINISTRATION REGULATIONS. DIVERSION CONTRARY TO U.S. LAW PROHIBITED.