

# PESDxL5UF; PESDxL5UV; PESDxL5UY

Low capacitance unidirectional fivefold ESD protection diode arrays

Rev. 02 — 8 January 2008

Product data sheet

## 1. Product profile

### 1.1 General description

Low capacitance unidirectional fivefold ElectroStatic Discharge (ESD) protection diode arrays in small Surface-Mounted Device (SMD) plastic packages designed to protect up to five unidirectional signal lines from the damage caused by ESD and other transients.

Table 1. Product overview

Type number	Package			Package configuration
	Nexperia	JEITA	JEDEC	
PESD3V3L5UF	SOT886	-	MO-252	leadless ultra small
PESD5V0L5UF	SOT886	-	MO-252	leadless ultra small
PESD3V3L5UV	SOT666	-	-	ultra small and flat lead
PESD5V0L5UV	SOT666	-	-	ultra small and flat lead
PESD3V3L5UY	SOT363	SC-88	-	very small
PESD5V0L5UY	SOT363	SC-88	-	very small

### 1.2 Features

- ESD protection of up to five lines
- Low diode capacitance
- Max. peak pulse power:  $P_{PP} = 25 \text{ W}$
- Low clamping voltage:  $V_{CL} = 12 \text{ V}$
- Ultra low leakage current:  $I_{RM} = 5 \text{ nA}$
- ESD protection up to 20 kV
- IEC 61000-4-2; level 4 (ESD)
- IEC 61000-4-5 (surge);  $I_{PP} = 2.5 \text{ A}$

### 1.3 Applications

- Computers and peripherals
- Audio and video equipment
- Cellular handsets and accessories
- Communication systems
- Portable electronics
- Subscriber Identity Module (SIM) card protection

**1.4 Quick reference data**

**Table 2. Quick reference data**  
*T<sub>amb</sub> = 25 °C unless otherwise specified.*

Symbol	Parameter	Conditions	Min	Typ	Max	Unit
<b>Per diode</b>						
V <sub>RWM</sub>	reverse standoff voltage					
	PESD3V3L5UF PESD3V3L5UV PESD3V3L5UY		-	-	3.3	V
	PESD5V0L5UF PESD5V0L5UV PESD5V0L5UY		-	-	5.0	V
C <sub>d</sub>	diode capacitance	f = 1 MHz; V <sub>R</sub> = 0 V				
	PESD3V3L5UF PESD3V3L5UV PESD3V3L5UY		-	22	28	pF
	PESD5V0L5UF PESD5V0L5UV PESD5V0L5UY		-	16	19	pF

**2. Pinning information**

**Table 3. Pinning**

Pin	Description	Simplified outline	Symbol
<b>PESD3V3L5UF; PESD5V0L5UF</b>			
1	cathode (diode 1)	<p>bottom view</p>	<p>006aaa159</p>
2	common anode		
3	cathode (diode 2)		
4	cathode (diode 3)		
5	cathode (diode 4)		
6	cathode (diode 5)		
<b>PESD3V3L5UV; PESD5V0L5UV</b>			
1	cathode (diode 1)		<p>006aaa159</p>
2	common anode		
3	cathode (diode 2)		
4	cathode (diode 3)		
5	cathode (diode 4)		
6	cathode (diode 5)		

**Table 3. Pinning ...continued**

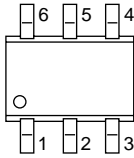
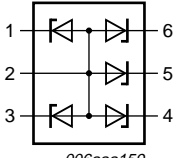
Pin	Description	Simplified outline	Symbol
<b>PESD3V3L5UY; PESD5V0L5UY</b>			
1	cathode (diode 1)		
2	common anode		
3	cathode (diode 2)		
4	cathode (diode 3)		
5	cathode (diode 4)		
6	cathode (diode 5)		

### 3. Ordering information

**Table 4. Ordering information**

Type number	Package		Version
	Name	Description	
PESD3V3L5UF PESD5V0L5UF	XSON6	plastic extremely thin small outline package; no leads; 6 terminals; body 1 × 1.45 × 0.5 mm	SOT886
PESD3V3L5UV PESD5V0L5UV	-	plastic surface-mounted package; 6 leads	SOT666
PESD3V3L5UY PESD5V0L5UY	SC-88	plastic surface-mounted package; 6 leads	SOT363

### 4. Marking

**Table 5. Marking codes**

Type number	Marking code <sup>[1]</sup>
PESD3V3L5UF	A1
PESD5V0L5UF	A2
PESD3V3L5UV	E1
PESD5V0L5UV	E2
PESD3V3L5UY	K3*
PESD5V0L5UY	K4*

[1] \* = -: made in Hong Kong  
 \* = p: made in Hong Kong  
 \* = t: made in Malaysia  
 \* = W: made in China

## 5. Limiting values

**Table 6. Limiting values**

In accordance with the Absolute Maximum Rating System (IEC 60134).

Symbol	Parameter	Conditions	Min	Max	Unit
<b>Per diode</b>					
$P_{PP}$	peak pulse power	$t_p = 8/20 \mu s$	[1][2] -	25	W
$I_{PP}$	peak pulse current	$t_p = 8/20 \mu s$	[1][2] -	2.5	A
<b>Per device</b>					
$T_j$	junction temperature		-	150	°C
$T_{amb}$	ambient temperature		-65	+150	°C
$T_{stg}$	storage temperature		-65	+150	°C

[1] Non-repetitive current pulse 8/20  $\mu s$  exponential decay waveform according to IEC 61000-4-5.

[2] Measured from pin 1, 3, 4, 5 or 6 to pin 2.

**Table 7. ESD maximum ratings**

$T_{amb} = 25^\circ C$  unless otherwise specified.

Symbol	Parameter	Conditions	Min	Max	Unit
<b>Per diode</b>					
$V_{ESD}$	electrostatic discharge voltage	IEC 61000-4-2 (contact discharge)	[1][2] -	20	kV
		MIL-STD-883 (human body model)	-	10	kV

[1] Device stressed with ten non-repetitive ESD pulses.

[2] Measured from pin 1, 3, 4, 5 or 6 to pin 2.

**Table 8. ESD standards compliance**

Standard	Conditions
<b>Per diode</b>	
IEC 61000-4-2; level 4 (ESD)	> 15 kV (air); > 8 kV (contact)
MIL-STD-883; class 3 (human body model)	> 4 kV

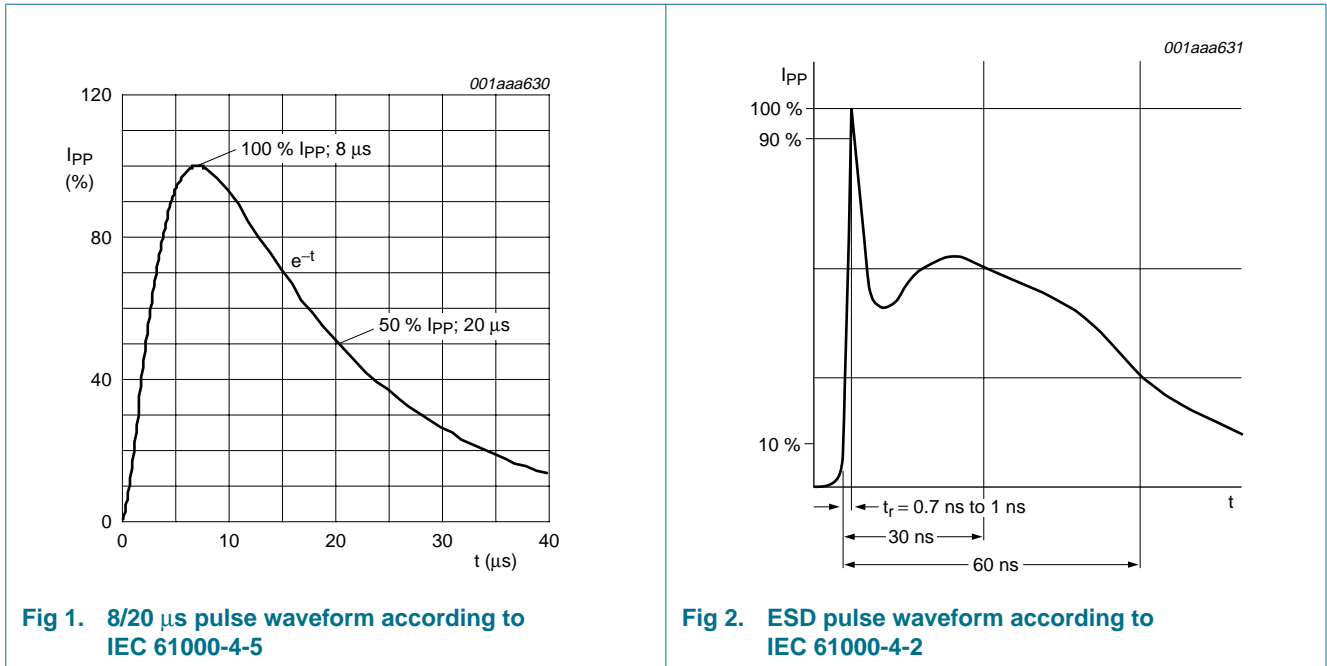

6. Characteristics

**Table 9. Characteristics**  
*T<sub>amb</sub> = 25 °C unless otherwise specified.*

Symbol	Parameter	Conditions	Min	Typ	Max	Unit
<b>Per diode</b>						
V <sub>RWM</sub>	reverse standoff voltage					
	PESD3V3L5UF PESD3V3L5UV PESD3V3L5UY		-	-	3.3	V
	PESD5V0L5UF PESD5V0L5UV PESD5V0L5UY		-	-	5.0	V
I <sub>RM</sub>	reverse leakage current					
	PESD3V3L5UF PESD3V3L5UV PESD3V3L5UY	V <sub>RWM</sub> = 3.3 V	-	75	300	nA
	PESD5V0L5UF PESD5V0L5UV PESD5V0L5UY	V <sub>RWM</sub> = 5.0 V	-	5	25	nA
V <sub>BR</sub>	breakdown voltage	I <sub>R</sub> = 1 mA				
	PESD3V3L5UF PESD3V3L5UV PESD3V3L5UY		5.3	5.6	5.9	V
	PESD5V0L5UF PESD5V0L5UV PESD5V0L5UY		6.4	6.8	7.2	V

**Table 9. Characteristics ...continued** $T_{amb} = 25^{\circ}\text{C}$  unless otherwise specified.

Symbol	Parameter	Conditions	Min	Typ	Max	Unit
$C_d$	diode capacitance	$f = 1\text{ MHz};$ $V_R = 0\text{ V}$				
	PESD3V3L5UF PESD3V3L5UV PESD3V3L5UY		-	22	28	pF
	PESD5V0L5UF PESD5V0L5UV PESD5V0L5UY		-	16	19	pF
	$V_{CL}$	clamping voltage		[1][2]		
	PESD3V3L5UF PESD3V3L5UV PESD3V3L5UY	$I_{PP} = 1\text{ A}$	-	-	10	V
	PESD3V3L5UF PESD3V3L5UV PESD3V3L5UY	$I_{PP} = 2.5\text{ A}$	-	-	12	V
PESD5V0L5UF PESD5V0L5UV PESD5V0L5UY	$I_{PP} = 1\text{ A}$	-	-	10	V	
PESD5V0L5UF PESD5V0L5UV PESD5V0L5UY	$I_{PP} = 2.5\text{ A}$	-	-	12	V	
$r_{dif}$	differential resistance	$I_R = 1\text{ mA}$				
	PESD3V3L5UF PESD3V3L5UV PESD3V3L5UY		-	-	200	$\Omega$
	PESD5V0L5UF PESD5V0L5UV PESD5V0L5UY		-	-	100	$\Omega$

[1] Non-repetitive current pulse 8/20  $\mu\text{s}$  exponential decay waveform according to IEC 61000-4-5.

[2] Measured from pin 1, 3, 4, 5 or 6 to pin 2.

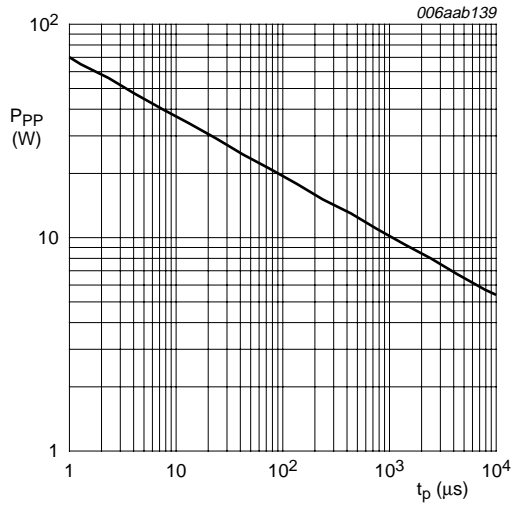

$T_{amb} = 25\text{ }^{\circ}\text{C}$

**Fig 3. Peak pulse power as a function of exponential pulse duration; typical values**

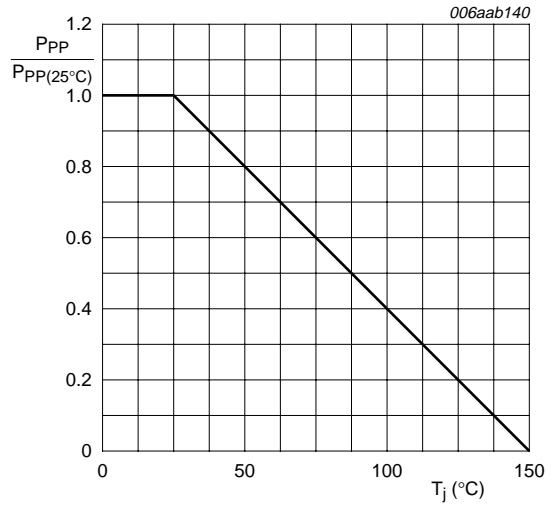

**Fig 4. Relative variation of peak pulse power as a function of junction temperature; typical values**

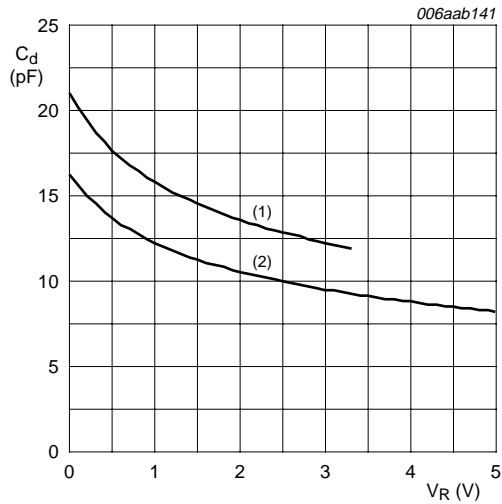

$f = 1\text{ MHz}; T_{amb} = 25\text{ }^{\circ}\text{C}$

- (1) PESD3V3L5UF; PESD3V3L5UV; PESD3V3L5UY
- (2) PESD5V0L5UF; PESD5V0L5UV; PESD5V0L5UY

**Fig 5. Diode capacitance as a function of reverse voltage; typical values**

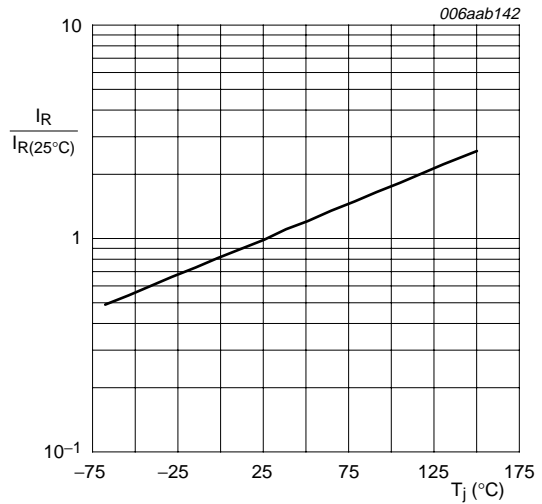

**Fig 6. Relative variation of reverse current as a function of junction temperature; typical values**

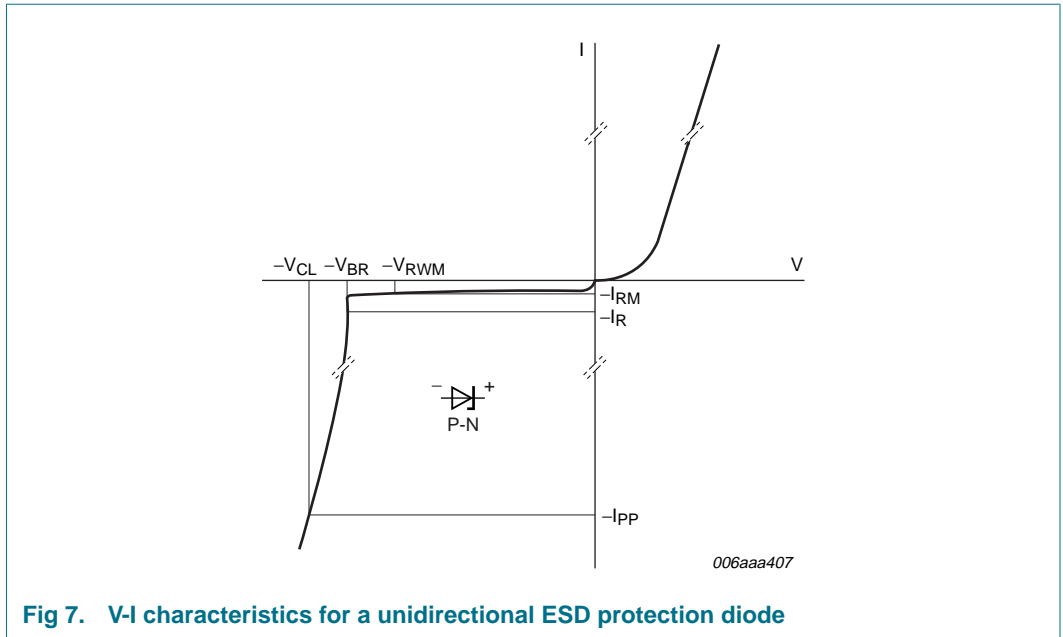

**Fig 7. V-I characteristics for a unidirectional ESD protection diode**



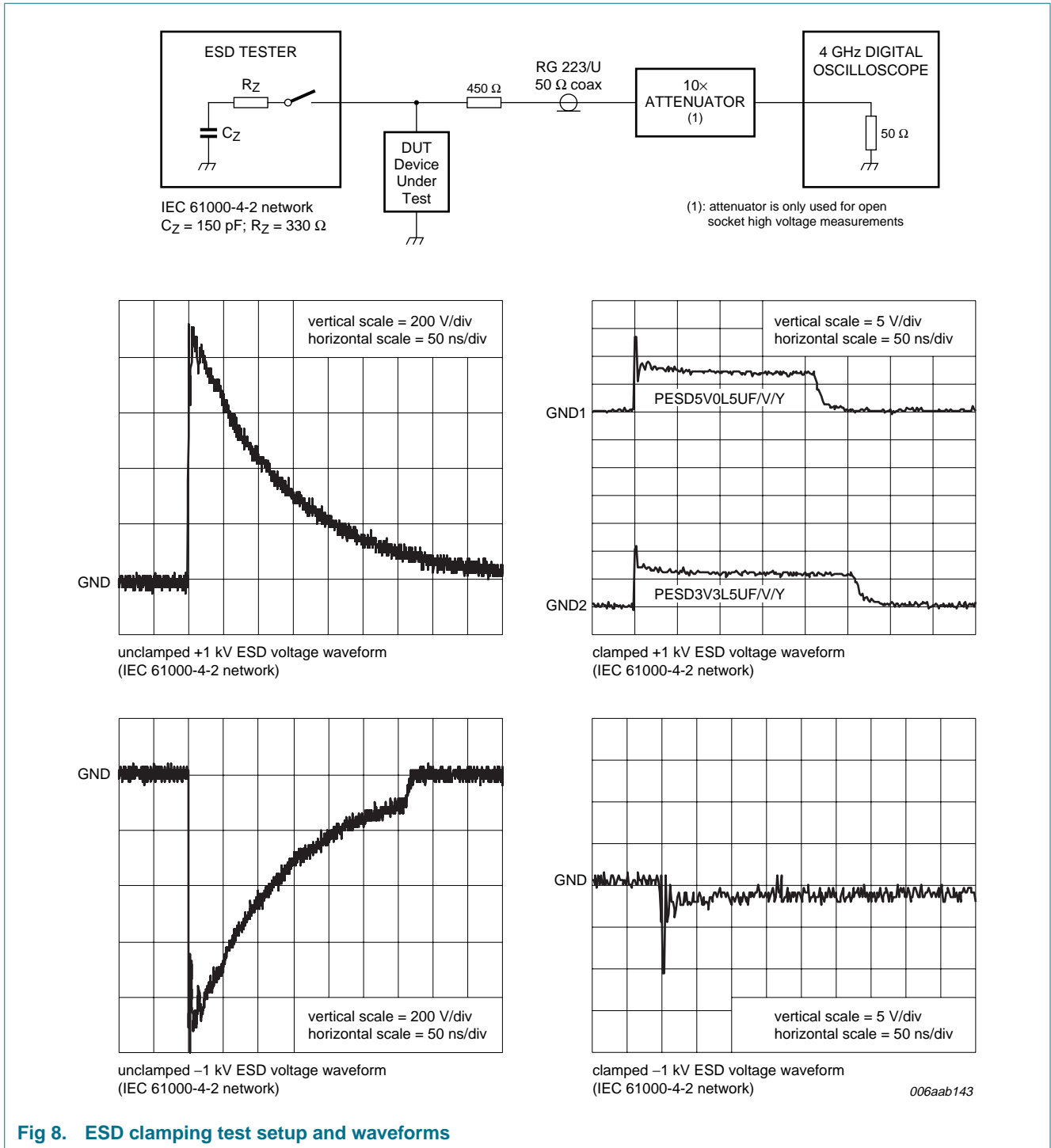
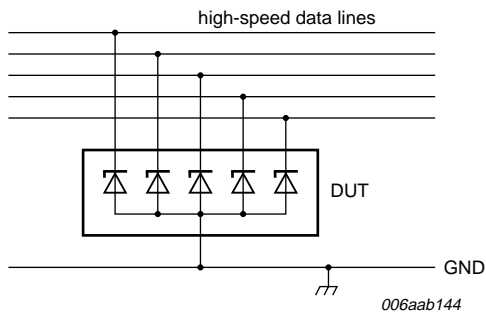

Fig 8. ESD clamping test setup and waveforms

## 7. Application information

The devices are designed for the protection of up to five unidirectional data or signal lines from the damage caused by ESD and surge pulses. The devices may be used on lines where the signal polarities are both, positive and negative with respect to ground. The devices provide a surge capability of 25 W per line for an 8/20  $\mu$ s waveform each.



**Fig 9. Typical application for unidirectional application of five lines**

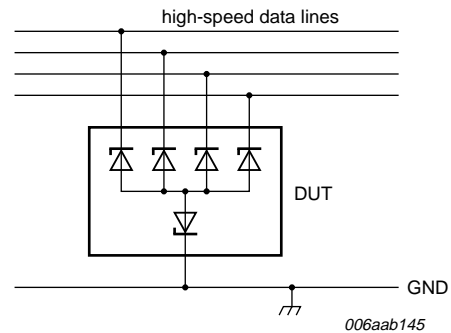

**Fig 10. Typical application for bidirectional application of four lines**

### Circuit board layout and protection device placement

Circuit board layout is critical for the suppression of ESD, Electrical Fast Transient (EFT) and surge transients. The following guidelines are recommended:

1. Place the device as close to the input terminal or connector as possible.
2. The path length between the device and the protected line should be minimized.
3. Keep parallel signal paths to a minimum.
4. Avoid running protected conductors in parallel with unprotected conductors.
5. Minimize all Printed-Circuit Board (PCB) conductive loops including power and ground loops.
6. Minimize the length of the transient return path to ground.
7. Avoid using shared transient return paths to a common ground point.
8. Ground planes should be used whenever possible. For multilayer PCBs, use ground vias.

**8. Package outline**

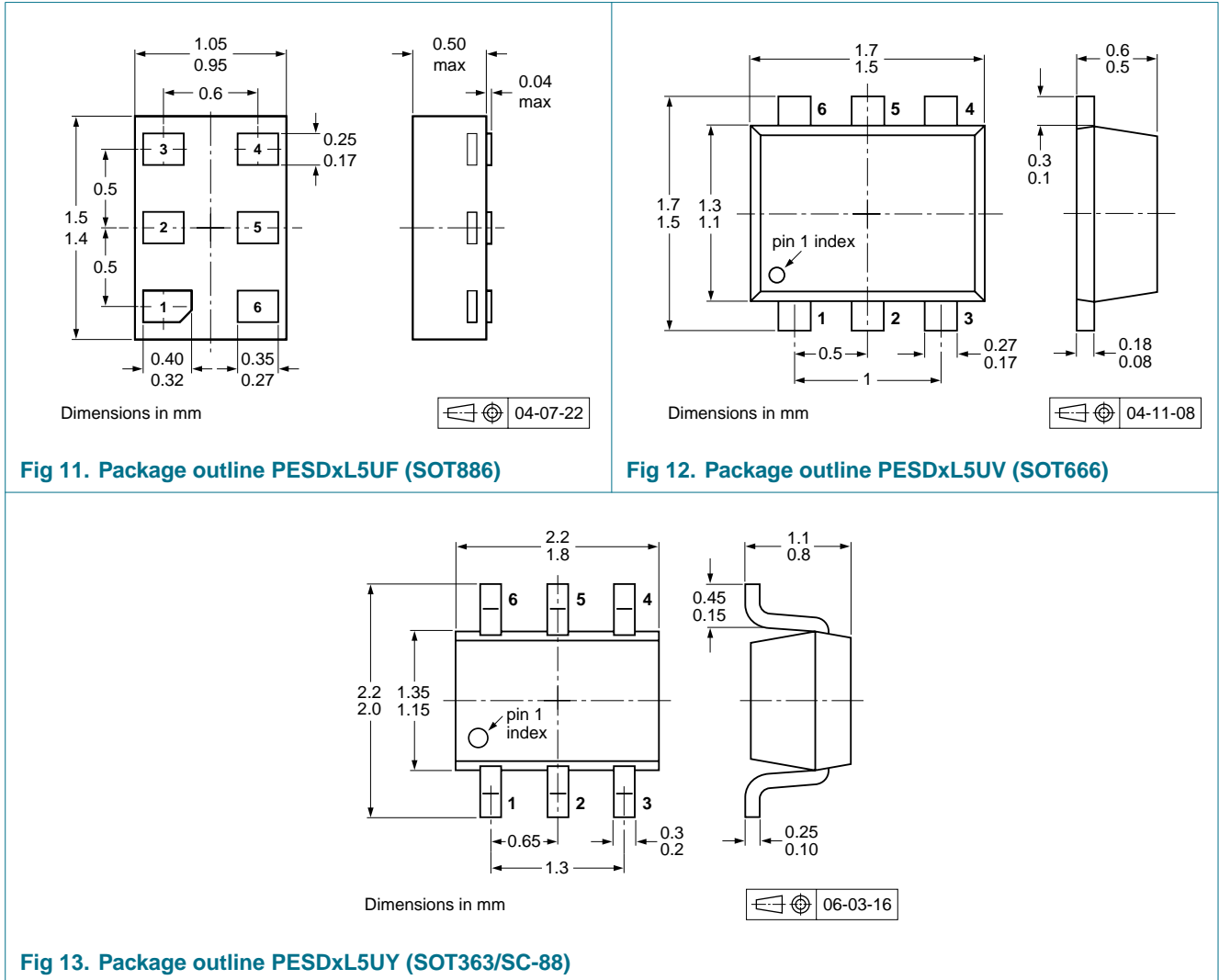

## 9. Packing information

**Table 10. Packing methods**

The indicated -xxx are the last three digits of the 12NC ordering code.<sup>[1]</sup>

Type number	Package	Description	Packing quantity					
			3000	4000	5000	8000	10000	
PESD3V3L5UF	SOT886	4 mm pitch, 8 mm tape and reel; T1	[2]	-	-	-115	-	-
		4 mm pitch, 8 mm tape and reel; T4	[3]	-	-	-132	-	-
PESD5V0L5UF	SOT886	4 mm pitch, 8 mm tape and reel; T1	[2]	-	-	-115	-	-
		4 mm pitch, 8 mm tape and reel; T4	[3]	-	-	-132	-	-
PESD3V3L5UV	SOT666	2 mm pitch, 8 mm tape and reel	-	-	-	-315	-	
		4 mm pitch, 8 mm tape and reel	-	-115	-	-	-	
PESD5V0L5UV	SOT666	2 mm pitch, 8 mm tape and reel	-	-	-	-315	-	
		4 mm pitch, 8 mm tape and reel	-	-115	-	-	-	
PESD3V3L5UY	SOT363	4 mm pitch, 8 mm tape and reel; T1	[2]	-115	-	-	-	-135
		4 mm pitch, 8 mm tape and reel; T2	[4]	-125	-	-	-	-165
PESD5V0L5UY	SOT363	4 mm pitch, 8 mm tape and reel; T1	[2]	-115	-	-	-	-135
		4 mm pitch, 8 mm tape and reel; T2	[4]	-125	-	-	-	-165

[1] For further information and the availability of packing methods, see [Section 13](#).

[2] T1: normal taping

[3] T4: 90° rotated reverse taping

[4] T2: reverse taping

## 10. Soldering

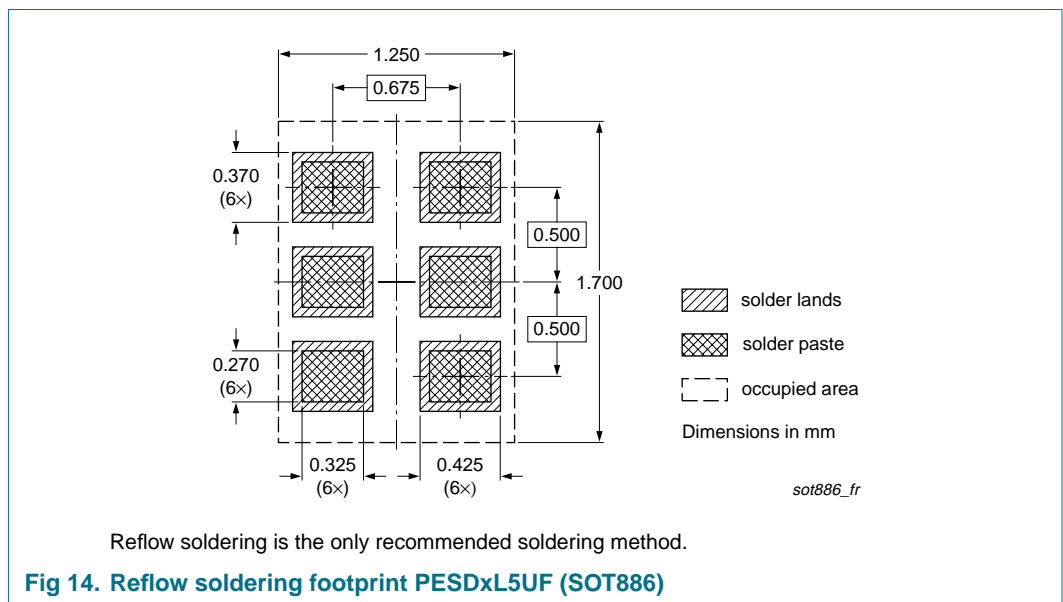

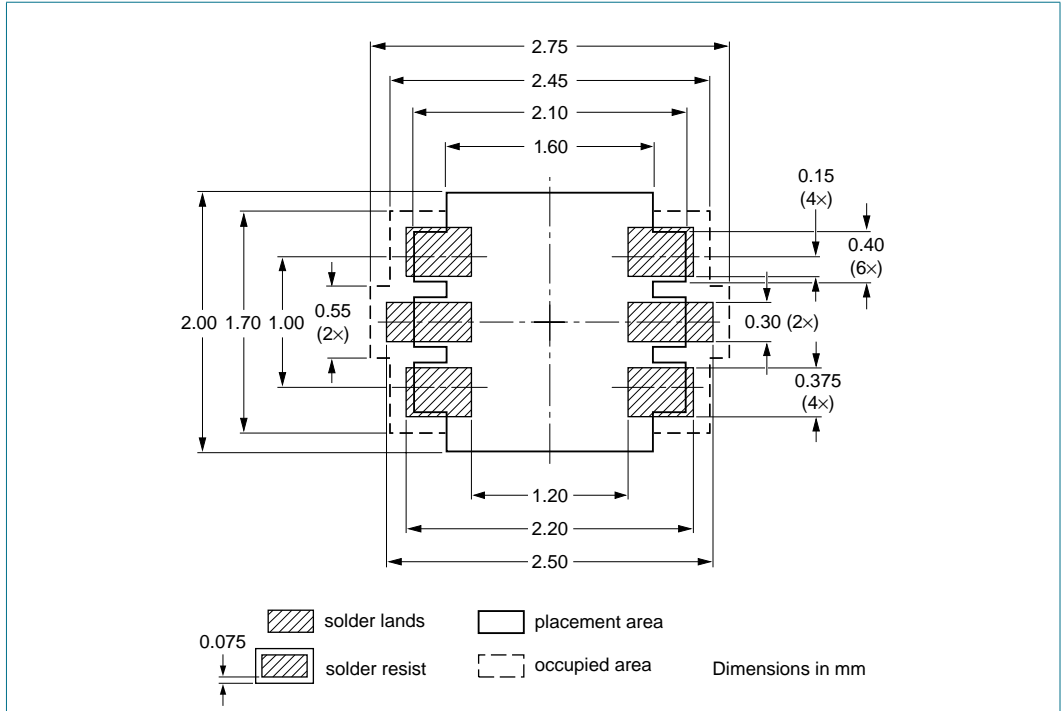

Reflow soldering is the only recommended soldering method.

Fig 15. Reflow soldering footprint PESDxL5UV (SOT666)

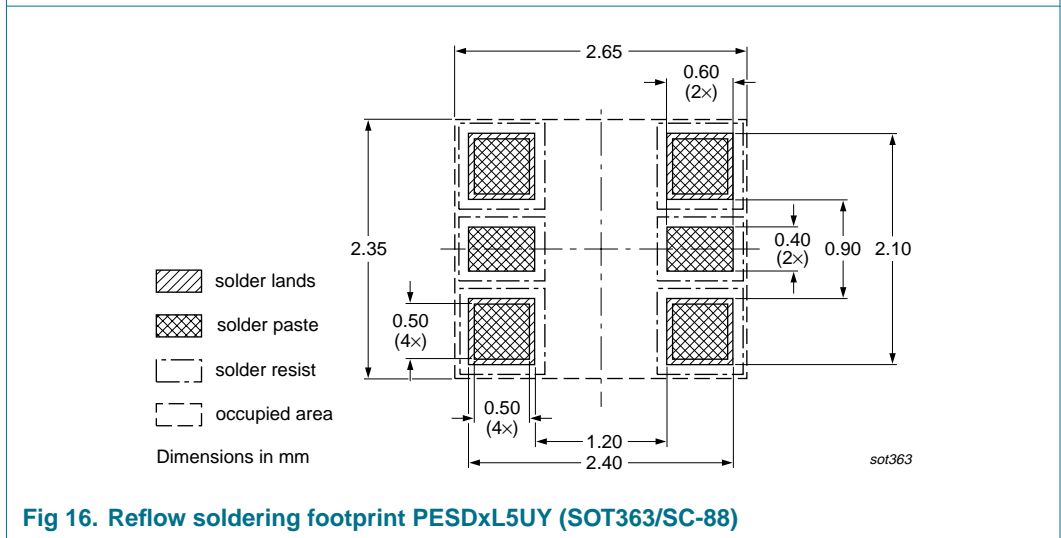
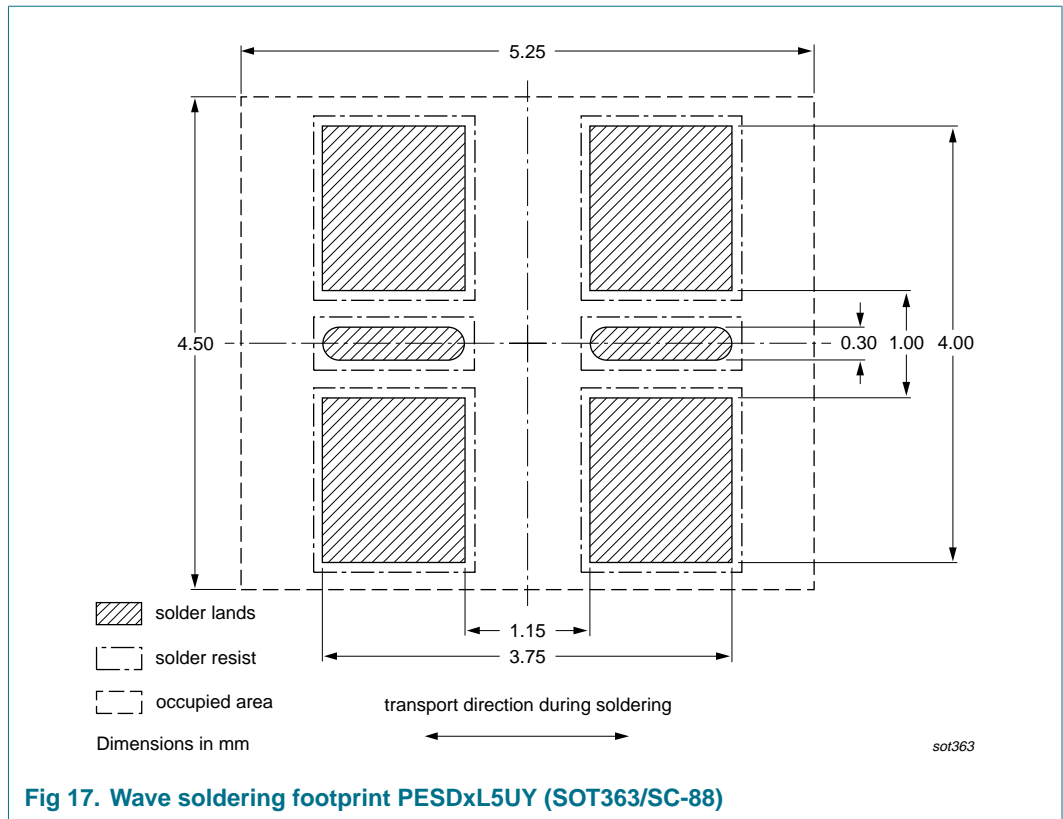

Fig 16. Reflow soldering footprint PESDxL5UY (SOT363/SC-88)



## 11. Revision history

Table 11. Revision history

Document ID	Release date	Data sheet status	Change notice	Supersedes
PESDXL5UF_V_Y_2	20080108	Product data sheet	-	PESD3V3L5UV_ PESD5V0L5UV_1 PESD3V3L5UY_ PESD5V0L5UY_1
Modifications:				<ul style="list-style-type: none"> <li>• The format of this data sheet has been redesigned to comply with the new identity guidelines of NXP Semiconductors.</li> <li>• Legal texts have been adapted to the new company name where appropriate.</li> <li>• Type numbers PESD3V3L5UF and PESD5V0L5UF added</li> <li>• <a href="#">Table 1 “Product overview”</a>: added</li> <li>• <a href="#">Section 4 “Marking”</a>: marking code for PESD3V3L5UV amended</li> <li>• <a href="#">Section 4 “Marking”</a>: marking code for PESD5V0L5UV amended</li> <li>• <a href="#">Section 4 “Marking”</a>: marking code for PESD3V3L5UY amended</li> <li>• <a href="#">Section 4 “Marking”</a>: marking code for PESD5V0L5UY amended</li> <li>• <a href="#">Figure 7</a>: added</li> <li>• <a href="#">Section 9 “Packing information”</a>: added</li> <li>• <a href="#">Section 10 “Soldering”</a>: added</li> <li>• <a href="#">Section 12 “Legal information”</a>: updated</li> </ul>
PESD3V3L5UV_PESD5V0L5UV_1	20040323	Product specification	-	-
PESD3V3L5UY_PESD5V0L5UY_1	20040323	Product specification	-	-

## 12. Legal information

### 12.1 Data sheet status

Document status <sup>[1][2]</sup>	Product status <sup>[3]</sup>	Definition
Objective [short] data sheet	Development	This document contains data from the objective specification for product development.
Preliminary [short] data sheet	Qualification	This document contains data from the preliminary specification.
Product [short] data sheet	Production	This document contains the product specification.

[1] Please consult the most recently issued document before initiating or completing a design.

[2] The term 'short data sheet' is explained in section "Definitions".

[3] The product status of device(s) described in this document may have changed since this document was published and may differ in case of multiple devices. The latest product status information is available on the Internet at URL <http://www.nexperia.com>.

### 12.2 Definitions

**Draft** — The document is a draft version only. The content is still under internal review and subject to formal approval, which may result in modifications or additions. Nexperia does not give any representations or warranties as to the accuracy or completeness of information included herein and shall have no liability for the consequences of use of such information.

**Short data sheet** — A short data sheet is an extract from a full data sheet with the same product type number(s) and title. A short data sheet is intended for quick reference only and should not be relied upon to contain detailed and full information. For detailed and full information see the relevant full data sheet, which is available on request via the local Nexperia sales office. In case of any inconsistency or conflict with the short data sheet, the full data sheet shall prevail.

### 12.3 Disclaimers

**General** — Information in this document is believed to be accurate and reliable. However, Nexperia does not give any representations or warranties, expressed or implied, as to the accuracy or completeness of such information and shall have no liability for the consequences of use of such information.

**Right to make changes** — Nexperia reserves the right to make changes to information published in this document, including without limitation specifications and product descriptions, at any time and without notice. This document supersedes and replaces all information supplied prior to the publication hereof.

**Suitability for use** — Nexperia products are not designed, authorized or warranted to be suitable for use in medical, military, aircraft, space or life support equipment, nor in applications where failure or

malfunction of a Nexperia product can reasonably be expected to result in personal injury, death or severe property or environmental damage. Nexperia accepts no liability for inclusion and/or use of Nexperia products in such equipment or applications and therefore such inclusion and/or use is at the customer's own risk.

**Applications** — Applications that are described herein for any of these products are for illustrative purposes only. Nexperia makes no representation or warranty that such applications will be suitable for the specified use without further testing or modification.

**Limiting values** — Stress above one or more limiting values (as defined in the Absolute Maximum Ratings System of IEC 60134) may cause permanent damage to the device. Limiting values are stress ratings only and operation of the device at these or any other conditions above those given in the Characteristics sections of this document is not implied. Exposure to limiting values for extended periods may affect device reliability.

**Terms and conditions of sale** — Nexperia products are sold subject to the general terms and conditions of commercial sale, as published at <http://www.nexperia.com/profile/terms>, including those pertaining to warranty, intellectual property rights infringement and limitation of liability, unless explicitly otherwise agreed to in writing by Nexperia. In case of any inconsistency or conflict between information in this document and such terms and conditions, the latter will prevail.

**No offer to sell or license** — Nothing in this document may be interpreted or construed as an offer to sell products that is open for acceptance or the grant, conveyance or implication of any license under any copyrights, patents or other industrial or intellectual property rights.

### 12.4 Trademarks

Notice: All referenced brands, product names, service names and trademarks are the property of their respective owners.

## 13. Contact information

For additional information, please visit: <http://www.nexperia.com>

For sales office addresses, send an email to: [salesaddresses@nexperia.com](mailto:salesaddresses@nexperia.com)



## 14. Contents

---

<b>1</b>	<b>Product profile</b> . . . . .	<b>1</b>
1.1	General description . . . . .	1
1.2	Features . . . . .	1
1.3	Applications . . . . .	1
1.4	Quick reference data . . . . .	2
<b>2</b>	<b>Pinning information</b> . . . . .	<b>2</b>
<b>3</b>	<b>Ordering information</b> . . . . .	<b>3</b>
<b>4</b>	<b>Marking</b> . . . . .	<b>3</b>
<b>5</b>	<b>Limiting values</b> . . . . .	<b>4</b>
<b>6</b>	<b>Characteristics</b> . . . . .	<b>5</b>
<b>7</b>	<b>Application information</b> . . . . .	<b>10</b>
<b>8</b>	<b>Package outline</b> . . . . .	<b>11</b>
<b>9</b>	<b>Packing information</b> . . . . .	<b>12</b>
<b>10</b>	<b>Soldering</b> . . . . .	<b>12</b>
<b>11</b>	<b>Revision history</b> . . . . .	<b>15</b>
<b>12</b>	<b>Legal information</b> . . . . .	<b>16</b>
12.1	Data sheet status . . . . .	16
12.2	Definitions . . . . .	16
12.3	Disclaimers . . . . .	16
12.4	Trademarks . . . . .	16
<b>13</b>	<b>Contact information</b> . . . . .	<b>16</b>
<b>14</b>	<b>Contents</b> . . . . .	<b>17</b>