



9 dB Fixed Attenuator, 2.92mm Male to 2.92mm Female
 Passivated Stainless Steel Body Rated to 2 Watts Up to 40 GHz

RF Fixed Attenuators Technical Data Sheet

PE7430-9

Features

- Bidirectional
- DC to 40 GHz Frequency Range
- Attenuation 9dB Typical
- Max Power 2 Watts (CW)
- VSWR < 1.35:1

Applications

- Instrumentation
- Precision measurements
- Prototyping and characterization
- Production systems

Description

Pasternack carries a wide range of fixed attenuators with a broad selection of attenuation levels, frequency ranges, and power dissipation ranges. RF microwave attenuators (also known as RF pads) lower the amplitude of a signal (attenuate) a known amount and can be used in a wide variety of applications. These attenuator pads are used when a signal needs to be reduced to protect measurement equipment or other circuitry, to extend the range of power meters and amplifiers, and to impedance match circuits by reducing the VSWR seen by adjacent components. RF attenuators can prevent signal overload in amplifiers, receivers and detectors, adjusting the signal level to a range that is optimal.

Few RF components are as commonly used as fixed coaxial attenuators, and Pasternack carries one of the largest in-stock varieties and ships them same day. The 9 dB Fixed Attenuator PE7430-9 is rated to 2 Watts and operates from DC to 40 GHz. The versatile coaxial package uses 2.92mm male to 2.92mm female connectors and is also REACH and RoHS compliant.

Electrical Specifications

Description	Minimum	Typical	Maximum	Units
Frequency Range	DC		40	GHz
Impedance		50		Ohms
Nominal Attenuation		9		dB
Attenuation Accuracy			1	dB
VSWR			1.35:1	
Input Power, CW			2	Watts
Input Power, Peak 5 μ s pulse, 1% Duty Cycle			200	Watts

Mechanical Specifications

Size

Weight 0.65 lbs [294.84 g]
 Body Material and Plating Passivated Stainless Steel

Click the following link (or enter part number in "SEARCH" on website) to obtain additional part information including price, inventory and certifications: [9 dB Fixed Attenuator, 2.92mm Male to 2.92mm Female Passivated Stainless Steel Body Rated to 2 Watts Up to 40 GHz PE7430-9](#)



9 dB Fixed Attenuator, 2.92mm Male to 2.92mm Female
Passivated Stainless Steel Body Rated to 2 Watts Up to 40 GHz

RF Fixed Attenuators Technical Data Sheet

PE7430-9

Configuration

Design Fixed

Connectors

Description	Connector 1	Connector 2
Type	2.92mm Male	2.92mm Female
Contact Material and Plating	Beryllium Copper, Gold	Beryllium Copper, Gold
Coupling Nut Material and Plating	Stainless Steel	
Body Material and Plating	Passivated Stainless Steel	Passivated Stainless Steel

Environmental Specifications

Temperature

Operating Range -55 to 125 deg C

Compliance Certifications (see [product page](#) for current document)

Plotted and Other Data

Notes:

9 dB Fixed Attenuator, 2.92mm Male to 2.92mm Female Passivated Stainless Steel Body Rated to 2 Watts Up to 40 GHz from Pasternack Enterprises has same day shipment for domestic and International orders. Our RF, microwave and millimeter wave products maintain a 99.4% availability and are part of the broadest selection in the industry.

Click the following link (or enter part number in "SEARCH" on website) to obtain additional part information including price, inventory and certifications: [9 dB Fixed Attenuator, 2.92mm Male to 2.92mm Female Passivated Stainless Steel Body Rated to 2 Watts Up to 40 GHz PE7430-9](#)

URL: <https://www.pasternack.com/9db-fixed-2.92mm-male-2.92mm-female-2-watts-attenuator-pe7430-9-p.aspx>

PE7430-9 CAD Drawing

9 dB Fixed Attenuator, 2.92mm Male to 2.92mm Female Passivated
Stainless Steel Body Rated to 2 Watts Up to 40 GHz

REVISIONS		
REV.	DESCRIPTION	DATE
A	INITIAL RELEASE	11/22/2021
		APPROVED

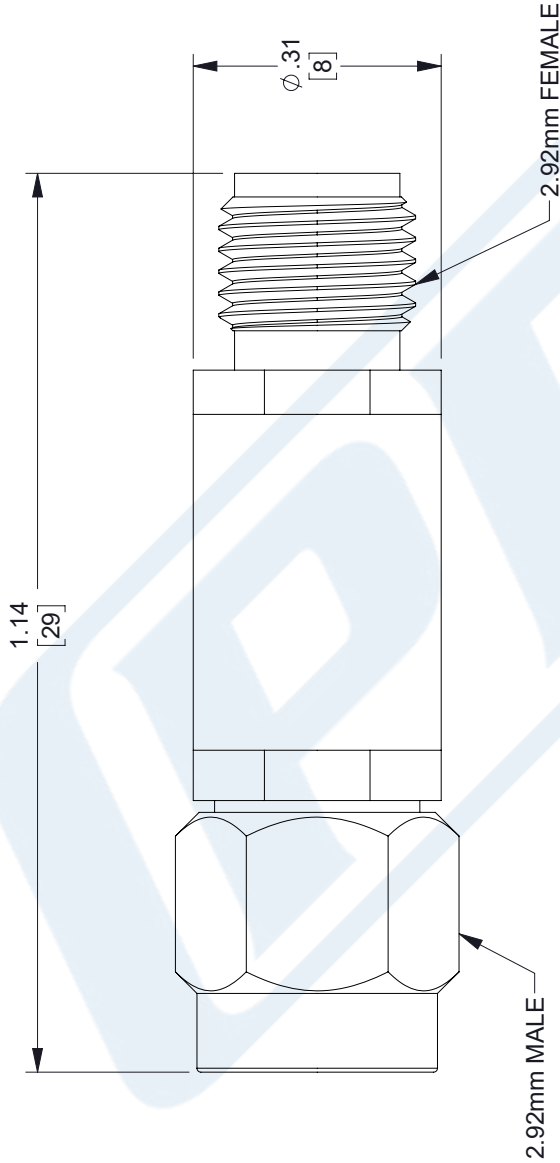

UNLESS OTHERWISE SPECIFIED
LEADING DIMENSIONS ARE INCHES
DIMENSIONS IN [] ARE MILLIMETERS

TOLERANCES:

.X = ±.2	[5.08]	FRACTIONS
.XX = ±.02	[.51]	±.1/32
.XXX = ±.005	[.13]	ANGLES ± 1°

CABLE LENGTH (L) TOLERANCES:

L ≤ 12	[305]	= +1 [25] / -0
12 [305] < L ≤ 60	[1524]	= +2 [51] / -0
60 [1524] < L ≤ 120	[3048]	= +4 [102] / -0
120 [3048] < L ≤ 300	[7620]	= +6 [152] / -0
300 [7620] < L		= +5%L / -0

ALL DIMENSIONS SHOWN
ARE FOR REFERENCE ONLY.



Pasternack Enterprises, Inc.
P. O. Box 16759, Irvine, CA 92623.
Phone: 1.949.261.1920 | 1.866.727.8376
Fax: 1.949.261.7451
Website: www.pasternack.com
E-mail: sales@pasternack.com



THE INFORMATION AND
DESIGN IN THIS DOCUMENT
IS THE PROPERTY OF
PASTERNAK CORPORATION
ALL RIGHTS RESERVED.

SHEET 1 OF 1

SCALE N/A

REV	REV
A	A
SIZE	ITEM NO.
A	PE7430-9
CAGE CODE	DRAWN BY
53919	DMAY

THESE COMMODITIES, TECHNOLOGY OR SOFTWARE WERE EXPORTED FROM THE UNITED STATES IN ACCORDANCE WITH THE EXPORT ADMINISTRATION REGULATIONS. DIVERSION CONTRARY TO U.S. LAW PROHIBITED.