

## SEK-18 SV MA STD STR45PR-IN 26P AUS4

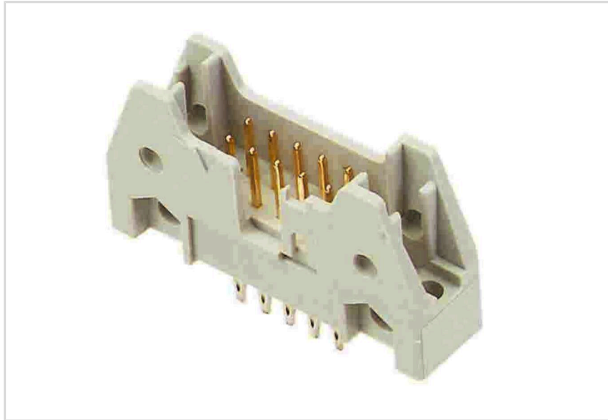

Image is for illustration purposes only. Please refer to product description.

Part number	09 18 526 5929
Specification	SEK-18 SV MA STD STR45PR-IN 26P AUS4
HARTING eCatalogue	<a href="https://b2b.harting.com/09185265929">https://b2b.harting.com/09185265929</a>

### Identification

Category	Connectors
Series	SEK Standard
Element	Male connector
Description of the contact	Straight

### Version

Termination method	Press-in termination
Connection type	PCB to cable
Number of contacts	26
Termination length	4.5 mm

### Technical characteristics

Contact rows	2
Contact spacing (termination side)	2.54 mm
Rated current	1 A
Insulation resistance	$>10^9 \Omega$
Contact resistance	$\leq 20 \text{ m}\Omega$
Limiting temperature	-55 ... +105 °C
Insertion and withdrawal force	$\leq 52 \text{ N}$
Performance level	NM 30 (S4)
Mating cycles	$\geq 250$
Test voltage $U_{r.m.s.}$	1 kV
Isolation group	IIIa ( $175 \leq \text{CTI} < 400$ )



Pushing Performance  
Since 1945

## Technical characteristics

PCB thickness	≥1.6 mm
---------------	---------

## Material properties

Material (insert)	Thermoplastic resin (PBT)
Colour (insert)	Grey
Material (contacts)	Copper alloy
Surface (contacts)	Noble metal over Ni Mating side Ni Termination side
Layer thickness	≥0.76 µm
Layer thickness	≥30 µinch
Material flammability class acc. to UL 94	V-0
RoHS	compliant
ELV status	compliant
China RoHS	e
REACH Annex XVII substances	Not contained
REACH ANNEX XIV substances	Not contained
REACH SVHC substances	Not contained

## Specifications and approvals

Specifications	IEC 60603-13
UL / CSA	UL 1977 ECBT2.E102079 CSA-C22.2 No. 182.3 ECBT8.E102079
Railway classification	F3/I3

## Commercial data

Packaging size	1
Country of origin	Czechia
European customs tariff number	85366990
GTIN	5713140031142
eCl@ss	27460201 PCB connector (board connector)

Recommended configuration of plated through holes

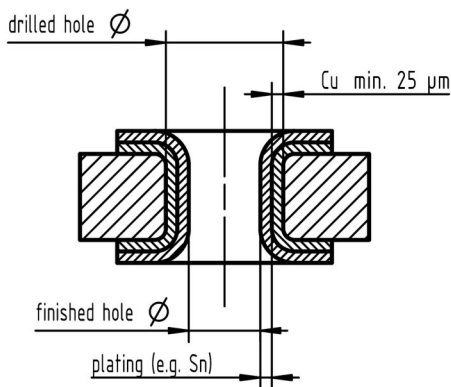

Tin plated PCB (HAL) acc. to EN 60352-5	Drilled hole Ø	1,15-0,03 mm
	Cu	min. 25 µm
	Sn	max. 15 µm
	plated hole Ø	0,94 - 1,09 mm
Chemical tin plated PCB	Drilled hole Ø	1,15-0,03 mm
	Cu	min. 25 µm
	Sn	min. 0,8µm
	plated hole Ø	1,00 - 1,10 mm
Gold /Nickel plated PCB	Drilled hole Ø	1,15-0,03 mm
	Cu	min. 25 µm
	Ni	3 - 7 µm
	Au	0,05 - 0,12 µm
Silver plated PCB	Drilled hole Ø	1,15-0,03 mm
	Cu	min. 25 µm
	Ag	0,1 - 0,3 µm
	plated hole Ø	1,00 - 1,10 mm
Copper plated PCB (OSP)	Drilled hole Ø	1,15-0,03 mm
	Cu	min. 25 µm
	plated hole Ø	1,00 - 1,10 mm

In addition to the hot-air-level (HAL) other pcb surfaces are getting more important. Due to their different properties, such as mechanical strength and coefficient of friction we recommend the above mentioned configuration of pcb through holes.