

Hinged frame HMC 24B f. 6 modules (a..f)

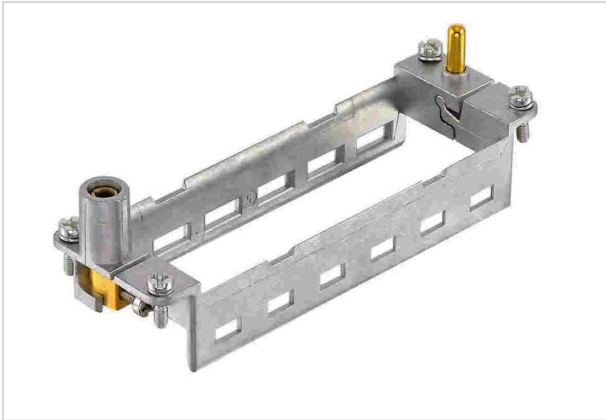

Image is for illustration purposes only. Please refer to product description.

Part number	09 14 224 0313
Specification	Hinged frame HMC 24B f. 6 modules (a..f)
HARTING eCatalogue	https://b2b.harting.com/09142240313

Identification

Category	Accessories
Series	Han-Modular®
Type of accessory	Hinged frame
Description of the accessory	HMC version for 6 modules a ... f
Features	Conductor cross-section PE (power side) 4 ... 10 mm ² Conductor cross-section PE (signal side) 1 ... 2.5 mm ²

Version

Size	24 B
------	------

Technical characteristics

Limiting temperature	-40 ... +125 °C
Mating cycles with other HMC components	≥10,000

Material properties

Material	Zinc die-cast
RoHS	compliant with exemption
RoHS exemptions	6(c): Copper alloy containing up to 4 % lead by weight
ELV status	compliant with exemption
China RoHS	50
REACH Annex XVII substances	Not contained
REACH ANNEX XIV substances	Not contained



Pushing Performance
Since 1945

Material properties

REACH SVHC substances	Yes
REACH SVHC substances	Lead
ECHA SCIP number	564b7d75-7bf6-4cfb-acb1-2168eb61b675
California Proposition 65 substances	Yes
California Proposition 65 substances	Lead Nickel

Specifications and approvals

Specifications	IEC 60664-1 IEC 61984
UL / CSA	UL 1977 ECBT2.E235076

Commercial data

Packaging size	2
Net weight	76.5 g
Country of origin	Germany
European customs tariff number	85389099
GTIN	5713140021563
ETIM	EC002312
eCl@ss	27440206 Module carrier frame for industrial connectors