

High power series connector (45A series)



TL300 Series

TL300 is a single pole metal connector that uses JPC's unique helical multi contacts for high power solutions. With straight and right angle plugs, HVIL, and shields, TL300 provides a variety of product configurations to choose from.

Technical Data

Current Rating	250A
Voltage Rating	1000V AC
Dielectric Withstanding Voltage	5000V AC
Operating Temperature Range	-40 °C to +125 °C
Mating Cycles	500 times Min.
Insulation resistance	500
Connector Type	Receptacle
Part Number	PCNTC202RC79-1

Product Features

Electrical interlock	Yes
Shielding	Yes/Optional
Automatic Secondary Lock	YES
Protection class	IP67 , IP2X

Application

High Voltage Power Distribution Unit(PDU)

DC-DC Converter

High Power Application

Energy Storage System

TL300 Series

Receptacle Interface Dimensions

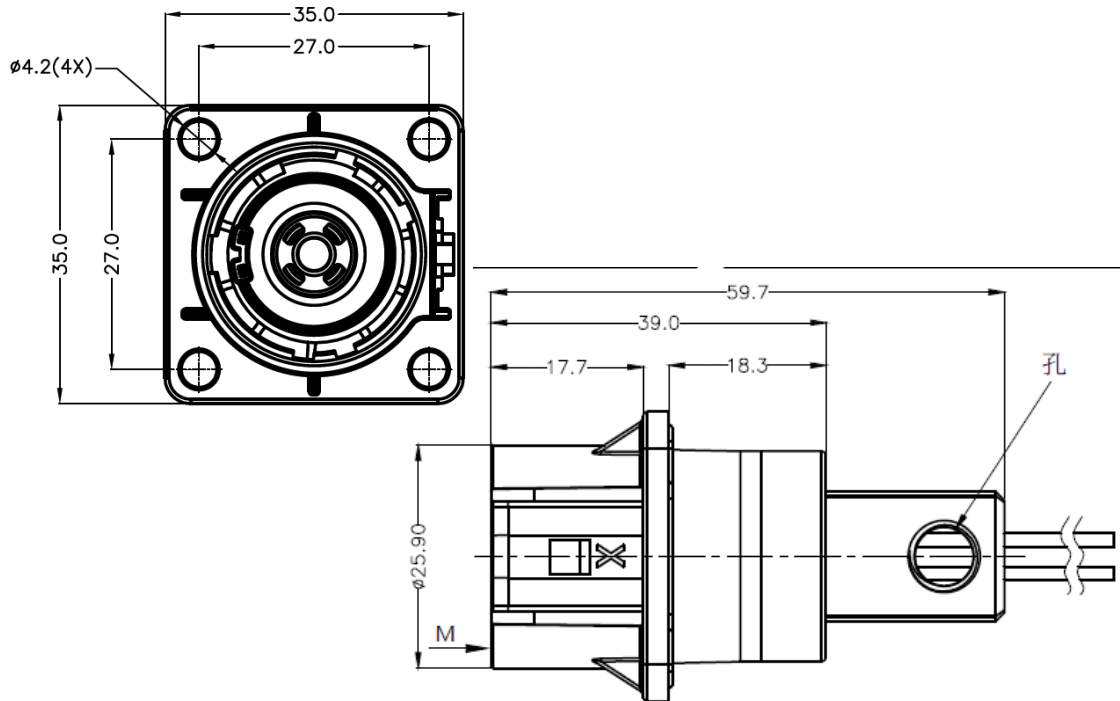

Key Direction

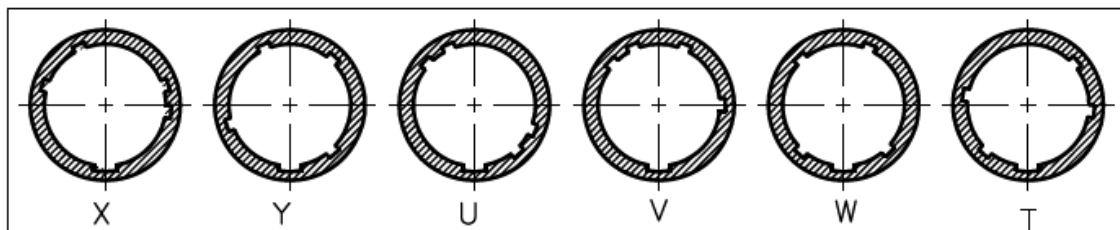

Panel Size

