

Silicon Carbide Schottky Barrier Diode

V_{RRM}	650 V	I_F	8 A
$V_{F(Typ.)}$	1.5 V	Q_C	16 nC

Features

- Temperature Independent Switching Behavior
- High Surge Current Capability
- Low Switching Loss
- Zero Reverse Recovery
- High junction temperature 175 °C
- Lead free in compliance with EU RoHS 2.0
- Green molding compound as per IEC 61249 standard

Mechanical Data

- Case: TO-220AC molded plastic
- Terminals: Solderable per MIL-STD-750, Method 2026
- Approx. Weight: 1.8903 grams

Application

- PFC, UPS, PV Inverter, EV Charging Station, Welder

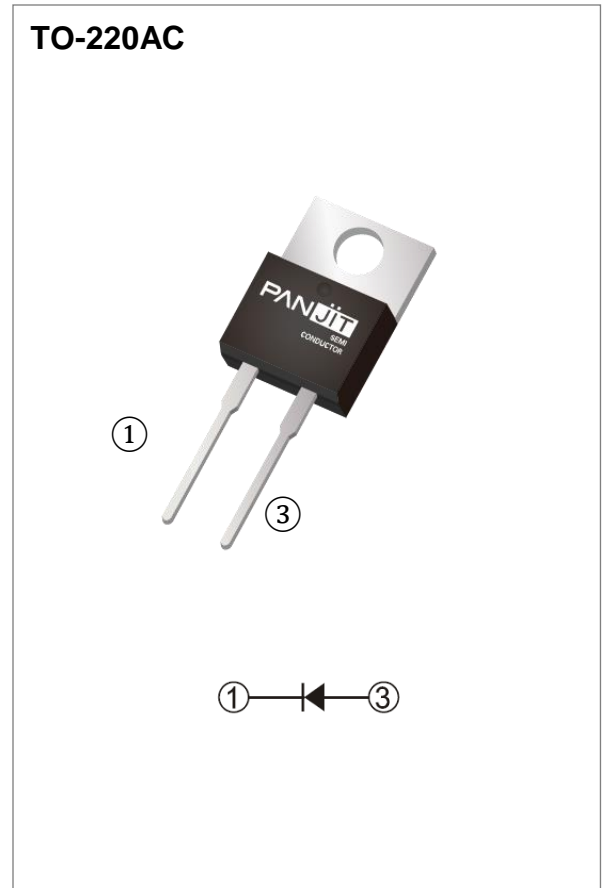

Maximum Ratings and Thermal Characteristics ($T_C = 25\text{ }^\circ\text{C}$ unless otherwise specified)

PARAMETER		SYMBOL	LIMIT	UNITS
Repetitive Peak Reverse Voltage		V_{RRM}	650	V
DC Blocking Voltage		V_{DC}	650	V
Continuous Forward Current	$T_C = 135\text{ }^\circ\text{C}$	I_F	8	A
Repetitive Peak Surge Current <i>Half Sine Wave, $D=0.1$</i>	$T_C = 25\text{ }^\circ\text{C}$, $t_p = 10\text{ms}$	I_{FRM}	24	A
	$T_C = 125\text{ }^\circ\text{C}$, $t_p = 10\text{ms}$		20	
Peak Forward Surge Current <i>Half Sine Wave</i>	$T_C = 25\text{ }^\circ\text{C}$, $t_p = 10\text{ms}$	I_{FSM}	28	A
	$T_C = 125\text{ }^\circ\text{C}$, $t_p = 10\text{ms}$		24	
Peak Forward Surge Current <i>$t_p = 10\mu\text{s}$, Pulse</i>			320	A
Maximum Power Dissipation		P_{total}	65.3	W
Operating Junction Temperature Range		T_J	-55~175	$^\circ\text{C}$
Storage Temperature Range		T_{STG}	-55~175	$^\circ\text{C}$

Electrical Characteristics ($T_c = 25\text{ }^\circ\text{C}$ unless otherwise specified)

PARAMETER	SYMBOL	TEST CONDITION	MIN.	TYP.	MAX.	UNITS
Forward Voltage Drop	V_F	$I_F = 8\text{ A}, T_J = 25\text{ }^\circ\text{C}$	-	1.5	1.8	V
		$I_F = 8\text{ A}, T_J = 175\text{ }^\circ\text{C}$	-	1.97	-	
Reverse Leakage Current	I_R	$V_R = 650\text{ V}, T_J = 25\text{ }^\circ\text{C}$	-	1.6	100	μA
		$V_R = 650\text{ V}, T_J = 175\text{ }^\circ\text{C}$	-	3	-	μA
Total Capacitive Charge	Q_C	$V_R = 400\text{V}$	-	16	-	nC
Total Capacitance	C	$V_R = 1\text{V}, f = 1\text{MHz}$	-	260	-	pF
		$V_R = 200\text{V}, f = 1\text{MHz}$	-	30	-	pF
		$V_R = 400\text{V}, f = 1\text{MHz}$	-	26	-	pF
Capacitance Stored Energy	E_C	$V_R = 400\text{V}$	-	2.4	-	μJ
Thermal Resistance	$R_{\theta JC}$		-	2.3	-	$^\circ\text{C/W}$

TYPICAL CHARACTERISTIC CURVES

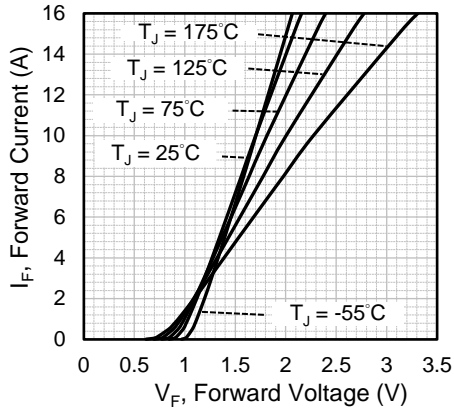

Fig.1 Forward Characteristics

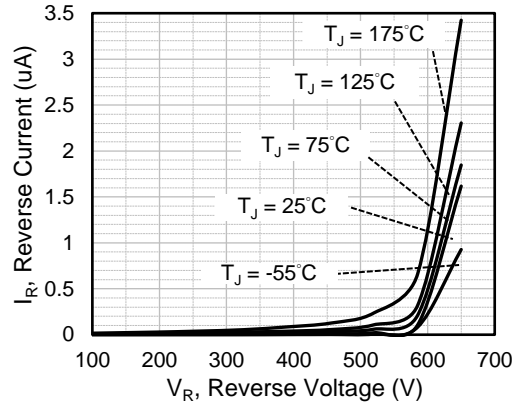

Fig.2 Reverse Characteristics

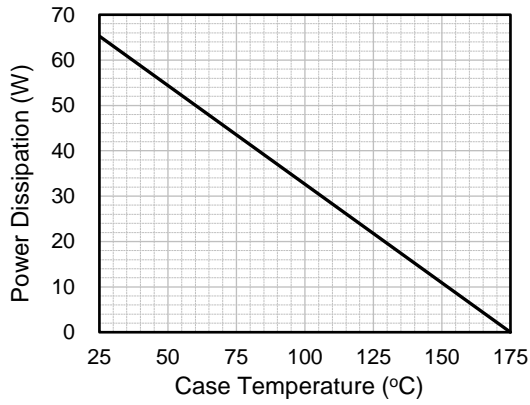

Fig.3 Power Derating Curve

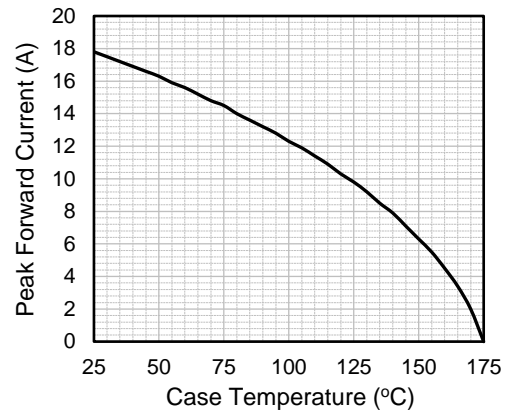

Fig.4 Current Derating Curve

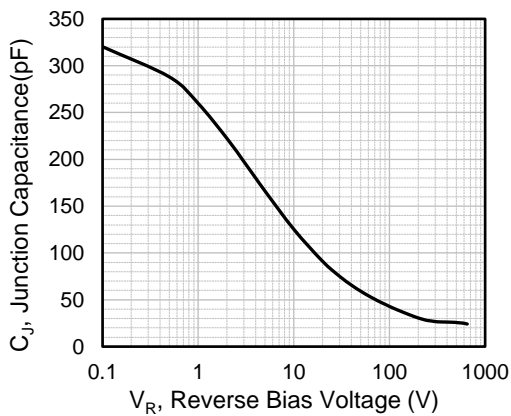

Fig.5 Typical Junction Capacitance

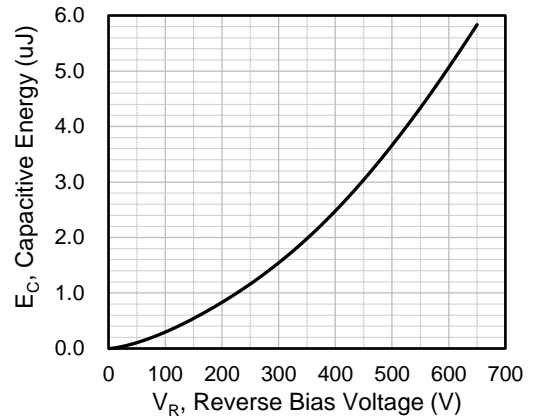
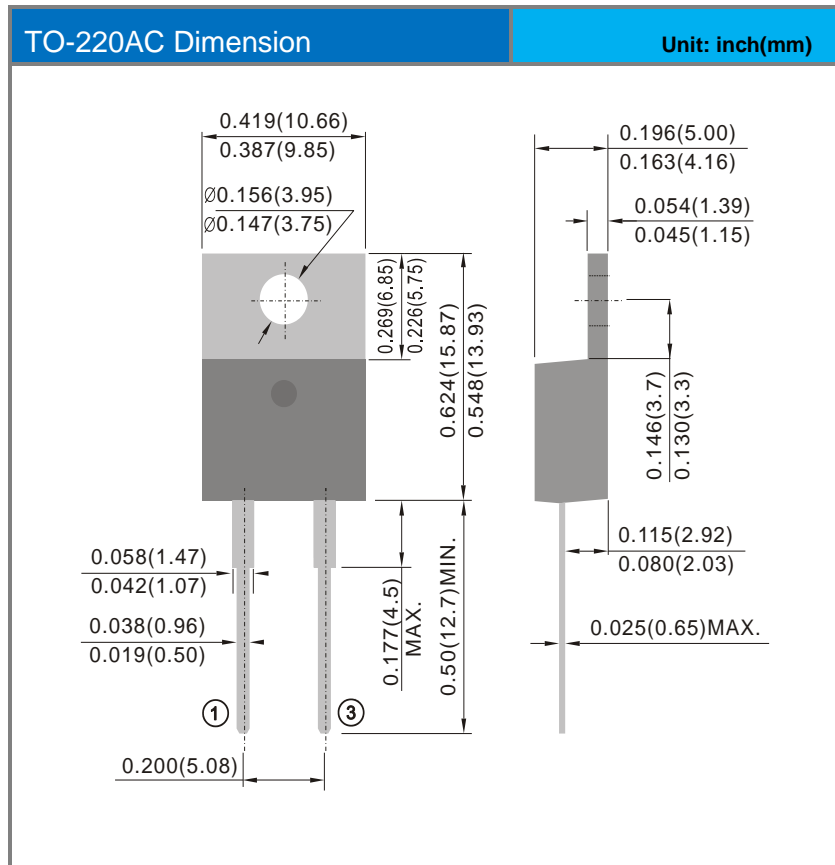

Fig.6 Capacitance Stored Energy

Product and Packing Information

Part No.	Package Type	Packing Type	Marking
PCDP0865GC	TO-220AC	50pcs / Tube	CDP0865GC

Packaging Information



Disclaimer

- Reproducing and modifying information of the document is prohibited without permission from Panjit International Inc..
- Panjit International Inc. reserves the rights to make changes of the content herein the document anytime without notification. Please refer to our website for the latest document.
- Panjit International Inc. disclaims any and all liability arising out of the application or use of any product including damages incidentally and consequentially occurred.
- Panjit International Inc. does not assume any and all implied warranties, including warranties of fitness for particular purpose, non-infringement and merchantability.
- Applications shown on the herein document are examples of standard use and operation. Customers are responsible in comprehending the suitable use in particular applications. Panjit International Inc. makes no representation or warranty that such applications will be suitable for the specified use without further testing or modification.
- The products shown herein are not designed and authorized for equipments requiring high level of reliability or relating to human life and for any applications concerning life-saving or life-sustaining, such as medical instruments, transportation equipment, aerospace machinery et cetera. Customers using or selling these products for use in such applications do so at their own risk and agree to fully indemnify Panjit International Inc. for any damages resulting from such improper use or sale.
- Since Panjit uses lot number as the tracking base, please provide the lot number for tracking when complaining.