



P3M12025K4 SiC MOS N-Channel Enhancement Mode

V_{RRM} = 1200 V
 I_D = 112 A
 $I_D(100^\circ\text{C})$ = 78 A
 $R_{DS(on)}$ = 25 m Ω

SiC MOS P3M12025K4 N-Channel Enhancement Mode

Features

- Qualified to AEC-Q101
- High Blocking Voltage with Low On-Resistance
- High-Frequency Operation
- Ultra-Small Q_{gd}
- 100% UIS tested

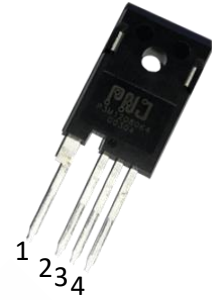

Standards Benefits

- Improve System Efficiency
- Increase Power Density
- Reduce Heat Sink Requirements
- Reduction of System Cost

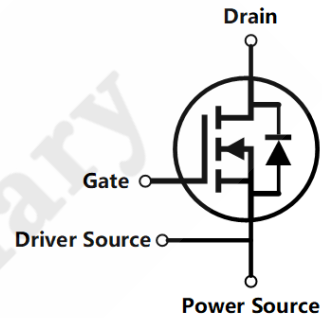

TO-247-4

Drain	1
Power Source	2
Driver Source	3
Gate	4

Application

- Solar Inverters
- EV Battery Chargers
- High Voltage DC/DC Converters
- Switch Mode Power Supplies



Order Information

Part number	Package	Marking
P3M12025K4	TO-247-4	P3M12025K4



Contents

Features.....	1
Standards Benefits	1
Application.....	1
Order Information	1
Contents.....	2
1. Maximum Ratings.....	3
2. Electrical Characteristics	4
3. Reverse Diode Characteristics	6
4. Thermal Characteristics.....	6
5. Typical Performance	7
6. Package Outlines.....	12

PNJ Preliminary



1. Maximum Ratings

At $T_J = 25^\circ\text{C}$, unless specified otherwise

Parameter	Symbol	Value	Unit	Test Conditions
Drain - Source Voltage	V_{DSmax}	1200	V	$V_{GS} = -3V$ $I_D = 100\mu A$
Gate - Source Voltage (Dynamic)	V_{GSmax}	-8 / +19	V	AC ($f > 1\text{Hz}$)
Gate - Source Voltage (Static)	V_{GSop}	-3 / +15	V	Static
Continuous Drain Current	I_D	112	A	$V_{GS} = 15V$ $T_C = 25^\circ\text{C}$
		78		$V_{GS} = 15V$ $T_C = 100^\circ\text{C}$
Power Dissipation	P_D	577	W	
Operating Junction Temperature	T_J	-55 To +175	$^\circ\text{C}$	
Storage Temperature	T_{stg}	-55 To +175	$^\circ\text{C}$	
Solder Temperature	T_L	260	$^\circ\text{C}$	
Mounting Torque	M_d	1 8.8	Nm lbf-in	M3 or 6-32 screw



2. Electrical Characteristics

At $T_J = 25^\circ\text{C}$, unless specified otherwise

Parameter	Symbol	Value			Unit	Test Conditions
		Min.	Typ	Max.		
Drain-Source Breakdown Voltage	$V_{(BR)DSS}$	1200	/	/	V	$V_{GS} = -3\text{V}$ $I_D = 100\mu\text{A}$
Gate Threshold Voltage	$V_{GS(th)}$	1.8	2.2	/	V	$V_{DS} = V_{GS}$ $I_D = 50\text{mA}$ $T_J = 25^\circ\text{C}$
		/	1.45	/	V	$V_{DS} = V_{GS}$ $I_D = 50\text{mA}$ $T_J = 175^\circ\text{C}$
Reverse Bias Drain Current	I_{DSS}	/	0.5	10	μA	$V_{GS} = -3\text{V}$ $V_{DS} = 1200\text{V}$
Gate-Source Leakage Current	I_{GSS}	/	20	250	nA	$V_{GS} = 15\text{V}$ $V_{DS} = 0\text{V}$
Drain-Source On-State Resistance	$R_{DS(on)}$	/	25	35	m Ω	$V_{GS} = 15\text{V}$ $I_D = 50\text{A}$ $T_J = 25^\circ\text{C}$
		/	28	/	m Ω	$V_{GS} = 15\text{V}$ $I_D = 50\text{A}$ $T_J = 125^\circ\text{C}$
		/	31	/	m Ω	$V_{GS} = 15\text{V}$ $I_D = 50\text{A}$ $T_J = 175^\circ\text{C}$
Trans conductance	g_{fs}	/	32.1	/	S	$V_{DS} = 20\text{V}$ $I_{DS} = 50\text{A}$ $T_J = 25^\circ\text{C}$
		/	32.6	/	S	$V_{DS} = 20\text{V}$ $I_{DS} = 50\text{A}$ $T_J = 175^\circ\text{C}$



P3M12025K4 SiC MOS N-Channel Enhancement Mode

Parameter	Symbol	Value			Unit	Test Conditions
		Min.	Typ	Max.		
Input Capacitance	C_{iss}	/	6775	/	pF	$V_{GS} = 0V$ $V_{DS} = 800V$ $f = 250kHz$ $V_{AC} = 25mV$
Output Capacitance	C_{oss}	/	228	/	pF	
Reverse Transfer Capacitance	C_{rss}	/	18	/	pF	
Coss Stored Energy	E_{oss}	/	170	/	μ	
Turn-on Energy	E_{on}	/	889.9	/	μ	$V_{DS} = 800V$ $V_{GS} = -3/15V$ $I_{DS} = 50A$ $R_G = 1\Omega$
Turn-off Energy	E_{off}	/	187.1	/		
Turn-On Delay Time	$T_{d(on)}$	/	20.16	/	ns	
Rise Time	T_r	/	33.6	/		
Turn-Off Delay Time	$T_{d(off)}$	/	44	/		
Fall Time	T_f	/	18.88	/		
Internal Gate Resistance	$R_{G(int)}$	/	1.54	/	Ω	
Gate to Source Charge	Q_{gs}	/	62.3	/	nC	$V_{DS} = 800V$ $I_{DS} = 50A$ $V_{GS} = -3 \text{ to } 15V$ $I_G = 50mA$
Gate to Drain Charge	Q_{gd}	/	43.5	/		
Total Gate Charge	Q_g	/	174	/		

3. Reverse Diode Characteristics

At $T_J = 25^\circ\text{C}$, unless specified otherwise

Parameter	Symbol	Value		Unit	Test Conditions
		Typ.	Max.		
Diode Forward Voltage	V_{SD}	4.5	/	V	$V_{GS} = -3V$ $I_{SD} = 25A$ $T_J = 25^\circ\text{C}$
		4.3	/	V	$V_{GS} = -3V$ $I_{SD} = 25A$ $T_J = 175^\circ\text{C}$
Continuous Diode Forward Current	I_S	86	/	A	$V_{GS} = -3V$
Reverse Recover Time	t_{rr}	21.92	/	ns	$V_{GS} = -3/15V$ $I_{SD} = 50A$ $V_R = 800V$ $dI_f/dt = 4300A/\mu s$ $T_J = 25^\circ\text{C}$
Reverse Recovery Charge	Q_{rr}	654.66	/	nC	
Peak Reverse Recovery Current	I_{rrm}	42.6	/	A	

4. Thermal Characteristics

Parameter	Symbol	Value	Unit
Thermal Resistance from Junction to Case	$R_{\theta JC}$	0.26	$^\circ\text{C}/\text{W}$

5. Typical Performance

At $T_J = 25^\circ\text{C}$, unless specified otherwise

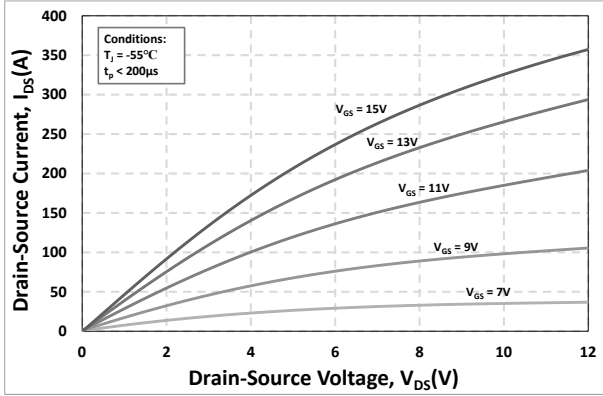

Figure 1. Output Characteristics $T_J = -55^\circ\text{C}$

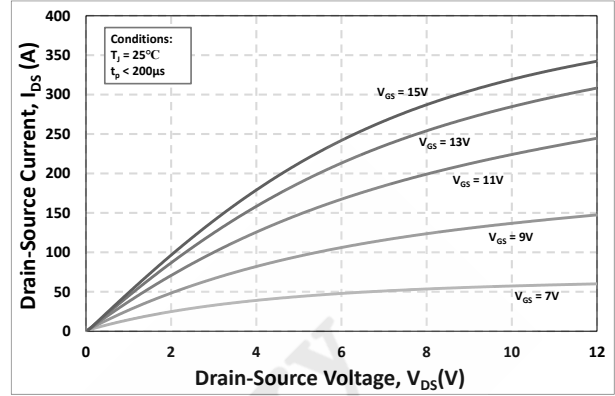

Figure 2. Output Characteristics $T_J = 25^\circ\text{C}$

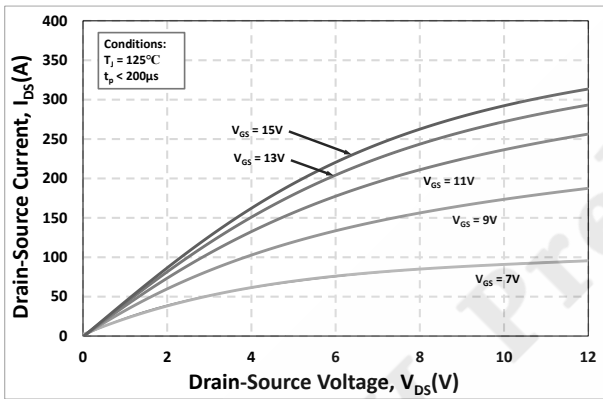

Figure 3. Output Characteristics $T_J = 125^\circ\text{C}$

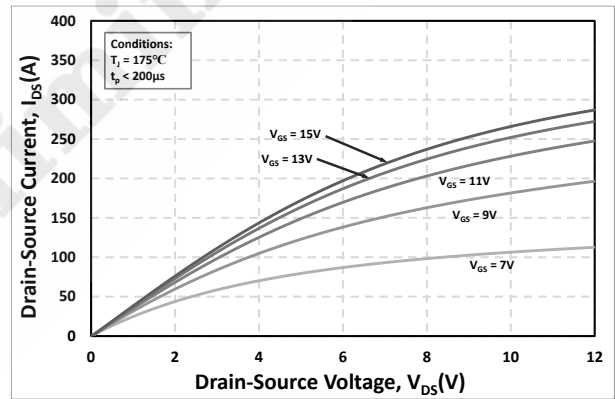

Figure 4. Output Characteristics $T_J = 175^\circ\text{C}$

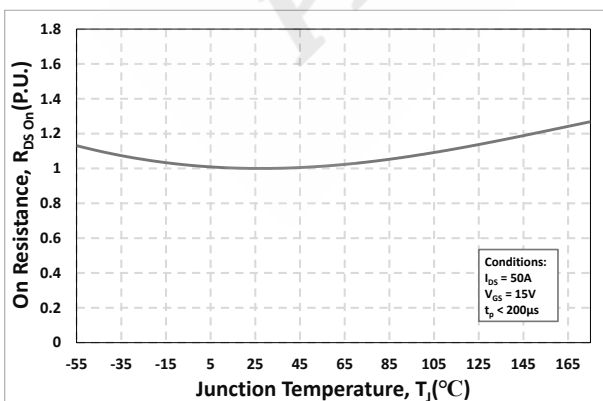

Figure 5. Normalized On-Resistance vs. Temperature

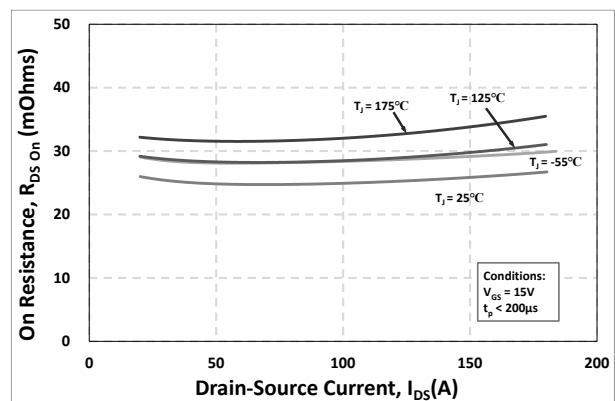

Figure 6. On-Resistance vs. Drain Current Various Temperatures

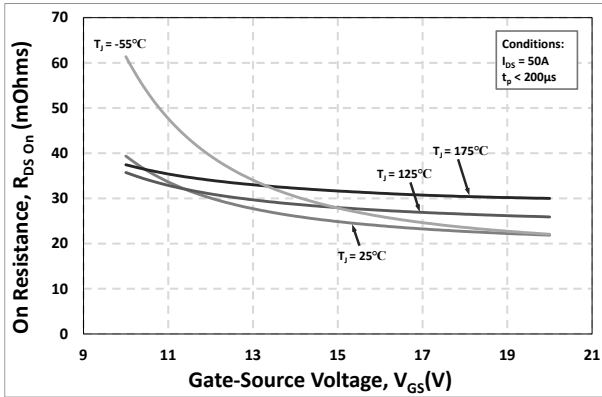

Figure 7. On-Resistance vs. Gate-Source Voltage

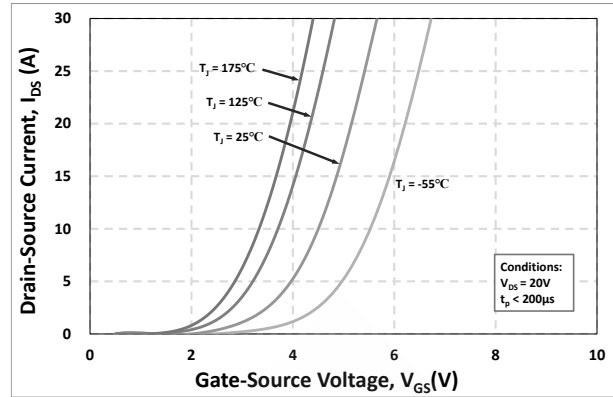

Figure 8. Transfer Characteristic for Various Junction Temperatures

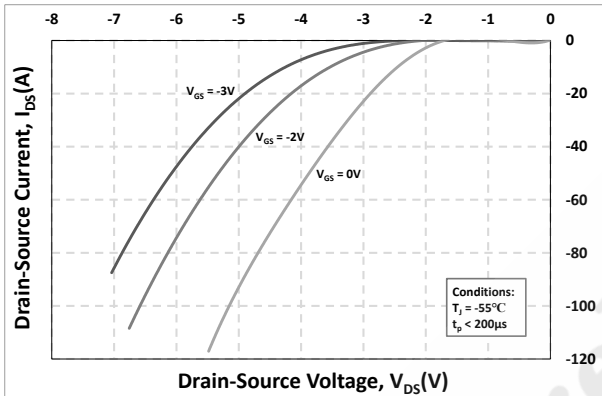

Figure 9. Body Diode Characteristic at -55°C

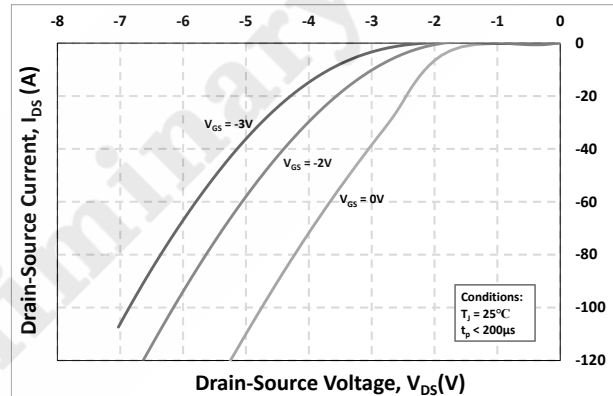

Figure 10. Body Diode Characteristic at 25°C

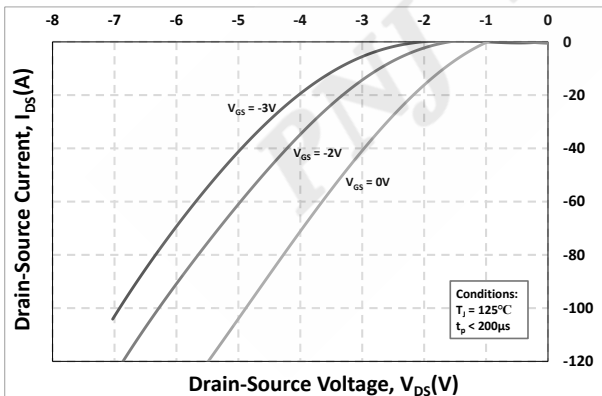

Figure 11. Body Diode Characteristic at 125°C

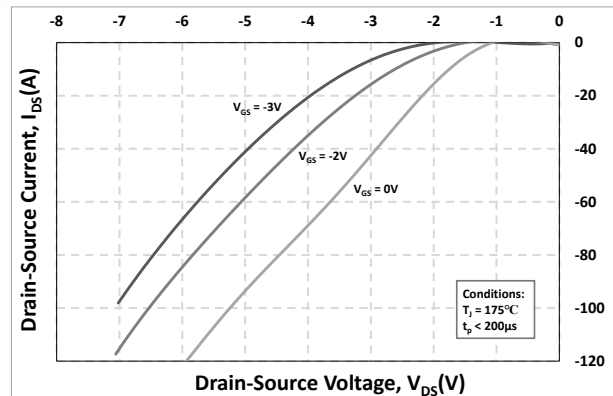

Figure 12. Body Diode Characteristic at 175°C



P3M12025K4 SiC MOS N-Channel Enhancement Mode

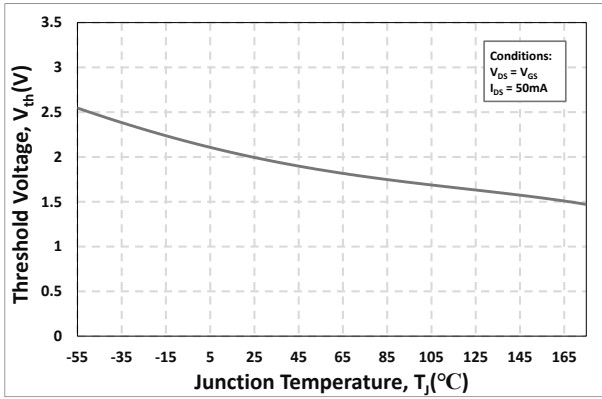

Figure 13. Threshold Voltage vs. Temperature

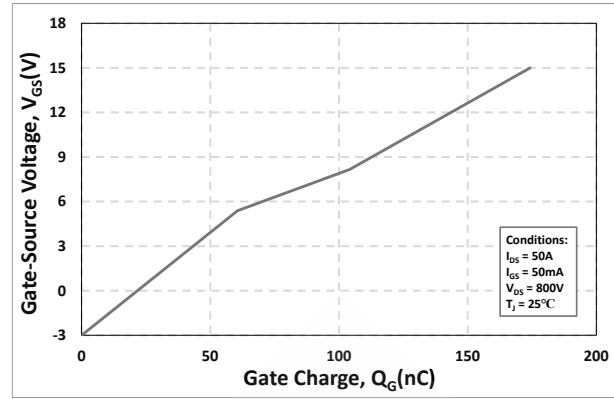

Figure 14. Gate Charge Characteristics

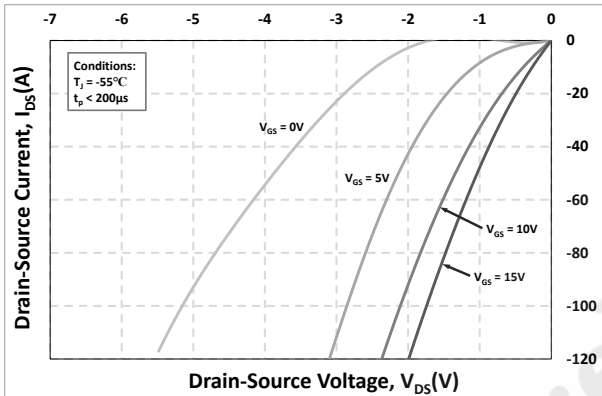

Figure 15. 3rd Quadrant Characteristic at -55°C

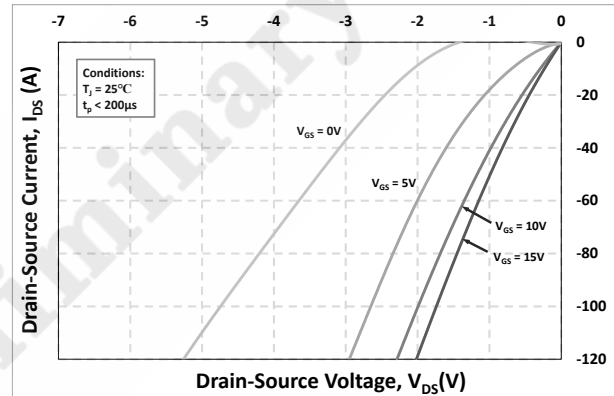

Figure 16. 3rd Quadrant Characteristic at 25°C

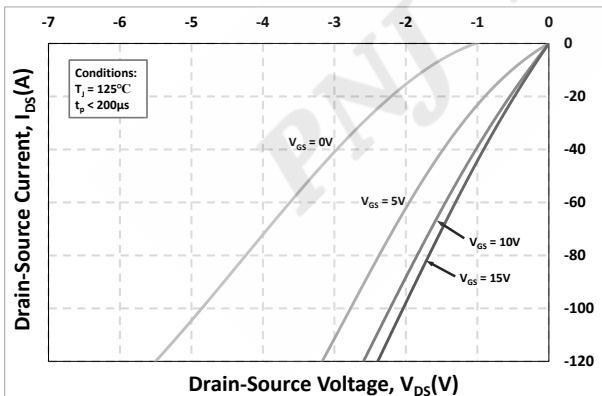

Figure 17. 3rd Quadrant Characteristic at 125°C

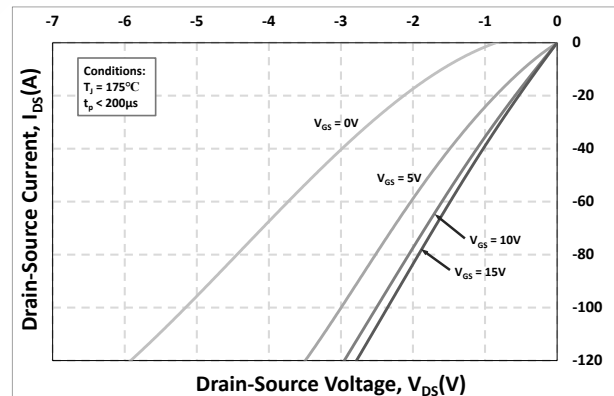

Figure 18. 3rd Quadrant Characteristic at 175°C

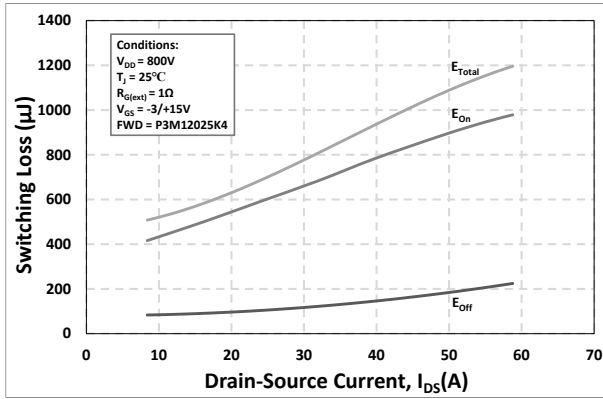

Figure 19. Clamped Inductive Switching Energy vs. Drain Current ($V_{DD} = 400V$)

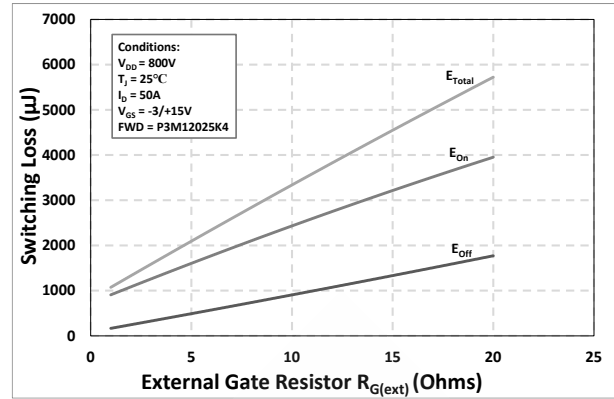

Figure 20. Clamped Inductive Switching Energy vs. $R_{G(ext)}$

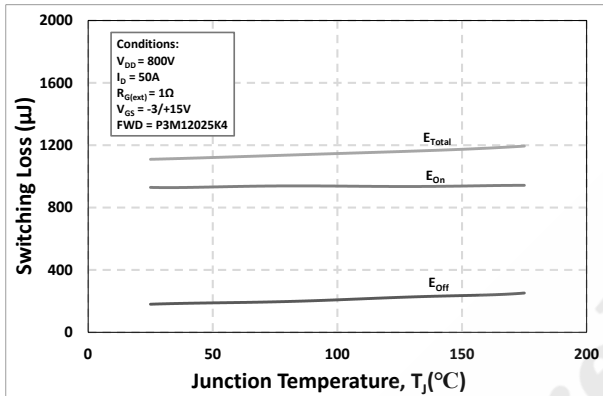

Figure 21. Clamped Inductive Switching Energy vs. Temperature

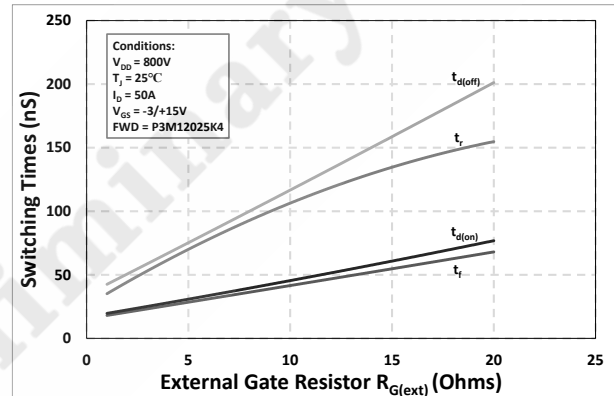

Figure 22. Switching Times vs. $R_{G(ext)}$

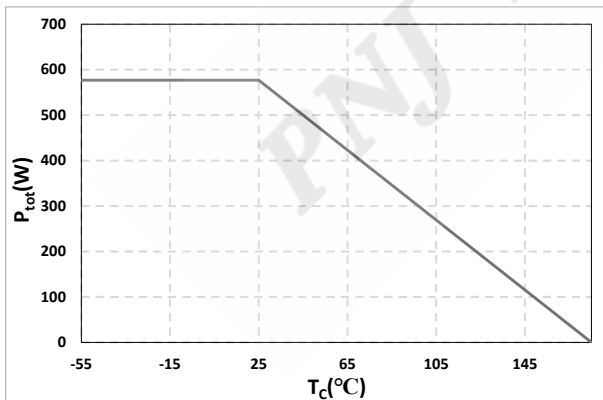

Figure 23. Maximum Power Dissipation Derating vs. Case Temperature

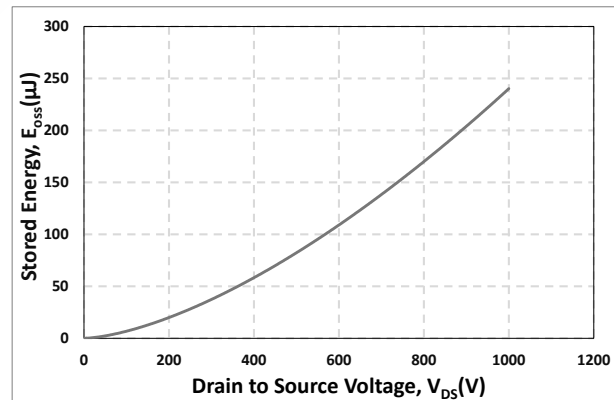

Figure 24. Output Capacitor Stored Energy

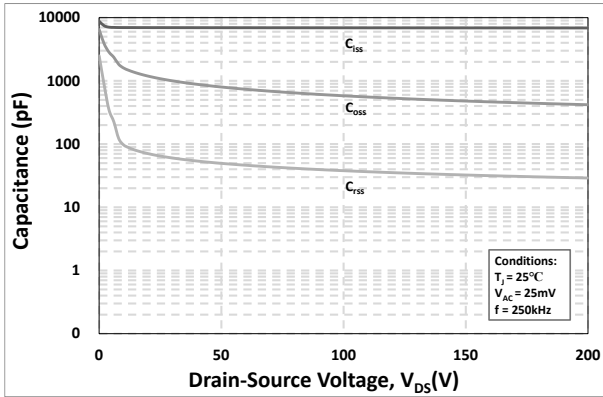

Figure 25. Capacitances vs. Drain-Source Voltage (0 - 200V)

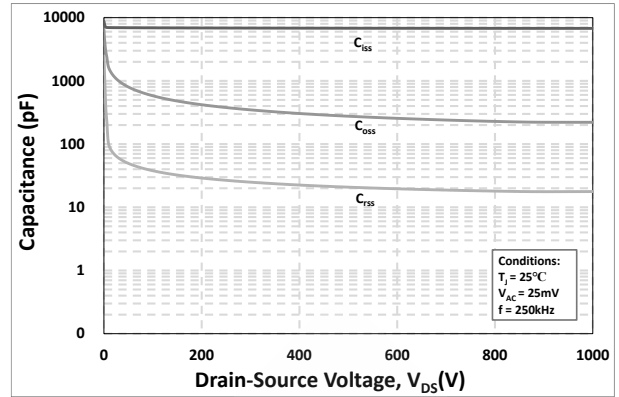

Figure 26. Capacitances vs. Drain-Source Voltage (0 - 1000V)

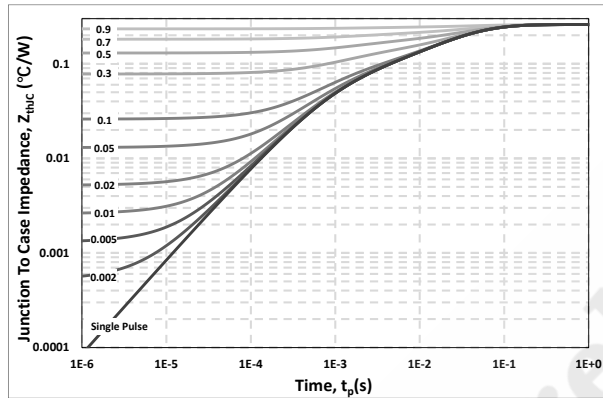

Figure 27. Transient Thermal Impedance (Junction - Case)

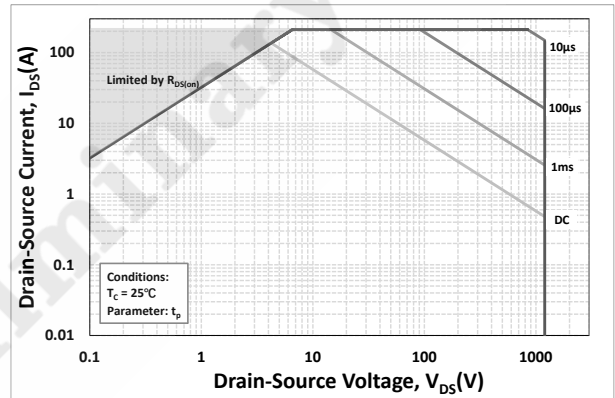
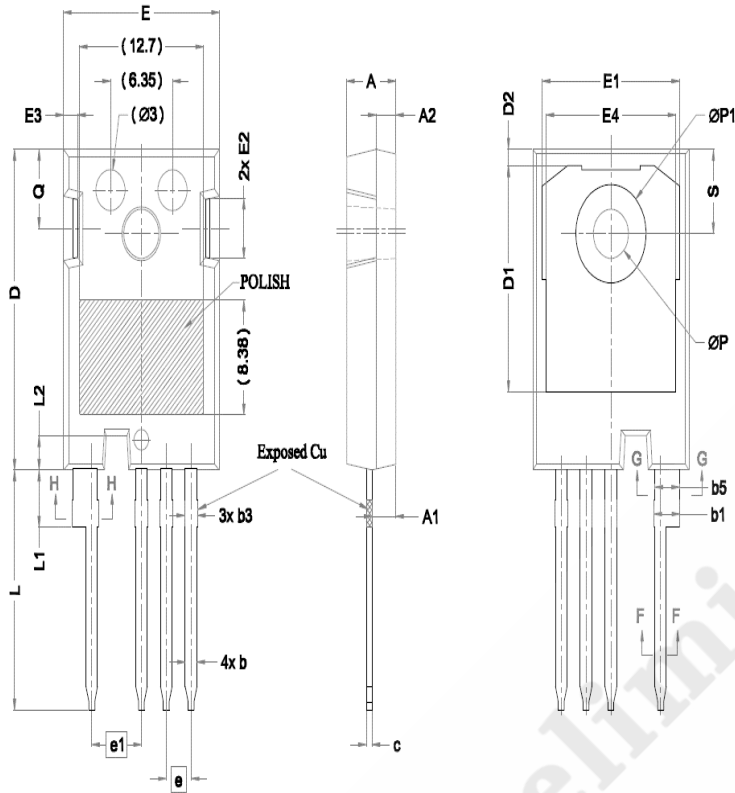

Figure 28. Safe Operating Area

PNJ PRELIMINARY

6. Package Outlines



Symbol	Dimensions		
	Min.	Nom.	Max.
A	4.83	5.02	5.21
A1	2.28	2.41	2.54
A2	1.91	2.00	2.16
b ¹	1.07	1.20	1.28
b	1.07	1.20	1.33
b1	2.39	2.67	2.94
b2	2.39	2.67	2.84
b3	1.07	1.30	1.60
b4	1.07	1.30	1.50
b5	2.39	2.53	2.69
b6	2.39	2.53	2.64
c	0.55	0.60	0.68
c1	0.55	0.60	0.65
D	22.30	23.45	23.80
D1	16.25	16.55	17.65
D2	0.95	1.19	1.25
E	15.75	15.94	16.13
E1	13.10	14.02	14.15
E2	3.60	1.10	5.10
E3	1.00	1.45	1.90
E4	12.38	13.26	13.43
e	2.54BSC		
e1	5.08BSC		
L	17.31	17.57	17.82
L1	3.97	4.19	4.37
L2	2.35	2.50	2.65
ØP	3.51	3.61	3.65
ØP	7.19 REF.		
Q	5.49	5.79	6.00
S	6.04	6.17	6.30

Drawing and dimensions