



Interactive
5 **CLICK FOR**
TABLE OF CONTENTS

CAMOZZI
Automation

North America
**Fittings &
Flow Control Valves**



Without creative ideas, there would be no technology

Ideas lead to the creation of new products, brilliant designs and innovative manufacturing solutions. Camozzi thrives on innovation and provides a stimulating environment where staff can express their creativity to the full, while manual and repetitive operations are undertaken

by highly automated machinery that conforms to stringent safety and environmental standards. Each component and accessory is designed, manufactured and tested to the highest possible specification to ensure consistent levels of product excellence are achieved.





Our commitment: the secret of our success

The structure and organization of our management team is central to Camozzi's continued growth and development, and is supported by sophisticated software systems for all operations, standardized to ensure vertical integration. The complex and widely varying needs of our customers set the agenda not only for innovative product development but also for quality, commitment and service,

and with Camozzi's worldwide sales organization we can reach you quickly anywhere in the world. In our quest for perfection and greater efficiency, Camozzi will meet the demands and expectations of an everchanging market, and the challenges laid down by our competitors, with optimism, fairness and enthusiasm.



Quality... an absolute and total commitment



Everybody talks about quality. We prefer to talk about the many components that work together to create a quality system that ensures excellence, not only in the final product but throughout the entire business process. Research, technological innovation, training, respect for personnel, employee and environmental safety, and total customer care are all factors that Camozzi considers strategic in the achievement of quality reflecting an unyielding commitment to the pursuit of excellence.

ISO 9001

Day by day we try to improve ourselves, to extend our competence and our professionalism in a consistent way.

Mandatory directives

- Directive 85/374/CE concerning liability for defective products modified by D.Lgs. 02/02/01 n° 25.
- Directive 2006/95/CE "Equipment designed for use within certain voltages".
- Directive 2004/108/CE "Electromagnetic Compatibility EMC" and repealing Directive 89/336/EEC.
- Directive 94/9/CE "Atex".
- Directive 2006/42/CE "Machinery".
- Directive 97/23/CE "Pressure equipment - PED".
- Directive 2001/95/CE "General products' safety".
- Regulation 1907/2006 concerning the registration, evaluation, authorisation and restriction of chemicals (REACH).

COMPANY WITH INTEGRATED MANAGEMENT SYSTEM
CERTIFIED BY DNV

ISO 9001 - ISO 14001

In 2003 Camozzi obtained from Det NorskeVeritas the certifications for the Quality Management Systems regarding ISO 9001/2000 and for the Environmental Management Systems as ISO 14001:1996. In 2006, "Det Norske Veritas" issued the new certification ISO 14001:2004, whereas in 2009, it issued the new certification ISO 9001:2008 confirming also certification ISO 14001:2004. One of Camozzi's main goals, equal to quality and safety, is the protection of the environment and compatibility of our activities with the territorial context in which they are performed.

From July 1, 2003, all products commercialized in the European Union and destined to be used in potentially explosive areas, should be approved according directive 94/9/CE better know as ATEX.

This new directive involves also the non electrical parts, as for instance pneumatic commands which should be approved.



ISO 14001

Minimize the consumption of energy, water, raw material and the production of waste, and focus on recycling wherever possible.

Technical standards

- ISO 4414 - Pneumatic fluid power - General rules relating to systems.

Environmental notes

- To protect the environment and health, our products are designed and manufactured to operate without lubrication. At the end of the product's life, we recommend the separation of the components to allow recycling.
- Packaging: we respect the environment, using materials which can be recycled. The packaging consists of plastic bags which are recyclable PVC and paper.
- Green Design Project: in the study of new products, the environmental impact is always taken into consideration (real project, elaboration, etc.).

Interactive Table of Contents

1 Push-In Fittings



2 Pipe Fittings



3 Compression Fittings



4 Flow Control Valves



5 Automatic Valves



6 Silencers



7 Tubing



8 Technical Data



Product Guide

Nickel-Plated Brass Push-In Fittings Series 6000



Tube Diameter OD : 1/8", 5/32", 1/4", 5/16", 3/8", 1/2"
3, 4, 5, 6, 8, 10, 12, 14, 16 mm
Thread Type : 10-32 UNF, 1/8", 1/4", 3/8", 1/2", 3/4 NPTF, or Pro-Fit® Seal
Metric (M3, M5, M6, M7) BSP (G1/8, G1/4, G3/8, G1/2, G3/4) with Sprint® Seal or Spot-Face O-ring Seal, BSPT (R1/8, R1/4, R3/8, R1/2) with Sprint® Seal

Nickel-Plated Brass DOT Fittings Series ND



Tube Diameter OD : 5/32", 1/4", 3/8", 1/2", 5/8", 3/4"
Thread Type : 10/32 UNF, 1/8", 1/4", 3/8", 1/2", 3/4" NPTF

Composite Push-In Fittings Series 7000



Tube Diameter OD : 5/32", 1/4", 5/16", 3/8", 1/2"
4, 6, 8, 10, 12, 16 mm
Thread Type : 10-32 UNF, 1/8", 1/4", 3/8", 1/2" NPTF with Pro-Fit® Seal
Metric(M5, M7), **BSP** (G1/8, G1/4, G3/8, G1/2, G3/4), with Spot-Face O-ring Seal

Push-in Self-Sealing Fittings Series 6000LF



Tube external diameters: 4 or 6 mm
Fittings threads: BSP G1/8

Nickel-Plated Brass High Pressure Push-In Fittings Series 8000 BSP/Metric



Tube Diameter OD: 4, 6, 8 mm and 10mm
Thread Type: BSP (G1/8 - G1/4 - G3/8), with Spot-Face O-ring Seal

Stainless Steel (316L) Push-In Fittings Series X6000 BSP/Metric



Tube Diameter OD: 4, 6, 8, 10, 12 mm
Thread Type: BSP (G1/8, G1/4, G3/8, G1/2), with Spot-Face O-ring Seal BSPT (R1/8, R1/4, R3/8, R1/2)

**Nickel-Plated Brass Pipe Fittings
Series 2000**



Thread Type : 10-32 UNF
NPTF (1/8", 1/4", 3/8", 1/2")
Metric (M5)
BSP (G1/8, G1/4, G3/8, G1/2, G3/4, G1)
BSPT (R1/8, R1/4, R3/8, R1/2, R3/4)

**2-Piece Compression Fittings
Series 1000**



Tube external diameters: 5/32, 6/32, 8/32, 10/32, 12/32, 15/32 mm
Fittings threads: metric (M5, M6, M12x1, M12x1.25),
BSP (G1/8, G1/4, G3/8, G1/2),
BSPT (R1/8, R1/4, R3/8, R1/2)

**Swivel Nickel-Plated Brass Flow Control Valves
Series GSCU, GMCU, GSVU, GMVU, GSCO, GMCO**



Swivel Design: Meter-Out, Meter-In and Needle Orifice
Tube Diameter OD : 1/8", 5/32", 1/4", 5/16", 3/8", 3mm, 4mm,
6mm, 8mm, 10mm
Thread Type : 10-32 UNF, 1/8", 1/4", 3/8", 1/2" NPTF
Metric M5, G1/8 and G1/4

**Fixed Banjo-Style Nickel-Plated Brass Flow Control Valve
Bodies and Adjustable Exhaust Controllers
Series SCU, MCU, SVU, MVU, SCO, MCO**



1
1
(banjo fittings required)
Thread Type: Metric (M5), BSP (G1/8, G1/4, G3/8, G1/2),
thread adapters required for BSPT/R

**Swivel Composite Flow Control Valves
Series TMCU, TMVU, TMCO**



Swivel Design : Meter-Out, Meter-In and Needle Orifice
Tube Diameter OD : 5/32", 1/4", 5/16", 3/8", 4mm, 6mm,
8mm, 10mm
Thread Type : 1/8", 1/4", 3/8", 1/2" NPTF with Pro-Fit® Seal
BSP (G1/8, G1/4, G3/8, G1/2) with Spot-Face O-ring
Seal

**Fixed Banjo-Style Composite Right Angle
Flow Control Valves
Series PSCU, PMCU, PSVU, PMVU, PSCO, PMCO**



Non-Swivel Design : Meter-Out, Meter-In and Needle Orifice
Tube Diameter OD : 4mm, 6mm, 8mm, 10mm, 12mm
Thread Type : Metric (M5), BSP (G1/8, G1/4, G3/8) with Spot-
Face O-ring Seal

In-line Flow Control Valves
Series RFU - RFO



Panel/Wall-Mount Design: Meter-Out, Meter-In
Needle-Orifice
Thread Type: 10-32 UNF, 1/8", 1/4", NPTF
Metric M5, G1/8, G1/4, G3/8 and G1/2

Nickel-Plated Brass Needle Valves
BSP/Metric, Series 28



Panel/Wall-Mount Design: Needle-Orifice
Thread Type: G1/8, G1/4, G3/8, G1/2

Nickel-Plated Brass Pilot-Operated Check Valve/
Blocking Valve
Series VBU, VBO



Swivel Design: 4mm / 5/32" OD Push-In Fitting Pilot
Thread Type: BSP (G1/8, G1/4, G3/8, G1/2) with Sprint®
Seal Seal NPT (1/8, 1/4, 3/8)

Exhausting
Series GSC



Thread Type: NPTF 1/8, 1/4, 3/8
BSP G1/8 - G1/4 - G3/8 - G1/2

Silencers - BSP/Metric
Series 2901, 2903, 2921, 2931, 2938, 2939, RSW



Threaded and Push-In Design: Sintered Bronze, Stainless
Steel Mesh and Polyethylene
Thread Type : M5, M7, G1/8, G1/4, G3/8, G1/2, G3/4, G1

Nylon Tubing
Series 1411



Diameters : OD Inch 1/8", 5/32", 1/4", 5/16", 3/8", 1/2"

**DOT Nylon Tubing
Series TEA**



Diameters : OD Inch 5/32", 1/4", 3/8", 1/2", 5/8", 3/4"

**Polyurethane Tubing
Series 1422**



Tubing : Reel Length 100' Feet.
Diameters : OD Inch 1/8", 5/32", 1/4", 5/16", 3/8", 1/2"

Additional Metric Tubing and Accessories



Metric Tubing : Reinforced PVC, Hytrel Polyester,
LDPE (Polyethylene), Nylon Coils
Diameter OD/ID: 4/2, 5/3, 6/4, 8/6, 10/8, 12/10,
15/12.5 mm

1 Push-In Fittings

Nickel-Plated Brass Push-In Fittings Series 6000



Tube Diameter OD : 1/8", 5/32", 1/4", 5/16", 3/8", 1/2"
3, 4, 5, 6, 8, 10, 12, 14, 16 mm
Thread Type : 10-32 UNF, 1/8", 1/4", 3/8", 1/2", 3/4 NPTF, or
Pro-Fit® Seal
Metric (M3, M5, M6, M7) BSP (G1/8, G1/4, G3/8,
G1/2, G3/4) with Sprint® Seal or Spot-Face
O-ring Seal, BSPT (R1/8, R1/4, R3/8, R1/2) with
Sprint® Seal

Nickel-Plated Brass DOT Fittings Series ND



Tube Diameter OD : 5/32", 1/4", 3/8", 1/2", 5/8", 3/4"
Thread Type : 10/32 UNF, 1/8", 1/4", 3/8", 1/2", 3/4" NPTF

Composite Push-In Fittings Series 7000



Tube Diameter OD : 5/32", 1/4", 5/16", 3/8", 1/2"
4, 6, 8, 10, 12, 16 mm
Thread Type : 10-32 UNF, 1/8", 1/4", 3/8", 1/2" NPTF with
Pro-Fit® Seal
Metric(M5, M7), **BSP** (G1/8, G1/4, G3/8,
G1/2, G3/4), with Spot-Face O-ring Seal

Push-in Self-Sealing Fittings Series 6000LF



Tube external diameters: 4 or 6 mm
Fittings threads: BSP G1/8

Nickel-Plated Brass High Pressure Push-In Fittings Series 8000 BSP/Metric



Tube Diameter OD: 4, 6, 8 mm and 10mm
Thread Type: BSP (G1/8 - G1/4 - G3/8), with Spot-Face
O-ring Seal

Stainless Steel (316L) Push-In Fittings Series X6000 BSP/Metric



Tube Diameter OD: 4, 6, 8, 10, 12 mm
Thread Type: BSP (G1/8, G1/4, G3/8, G1/2), with Spot-Face
O-ring Seal BSPT (R1/8, R1/4, R3/8, R1/2)

NPTF/INCH Thread Assembly & Interchange

Composite Fitting with *Pro-Fit* Thread (ex: P7524 04-04)

Nickel-Plated Brass with *Pro-Fit* Thread (ex: P6510 04-04)

Nickel-Plated Brass with Standard NPTF Thread (ex: 6510 04-04)

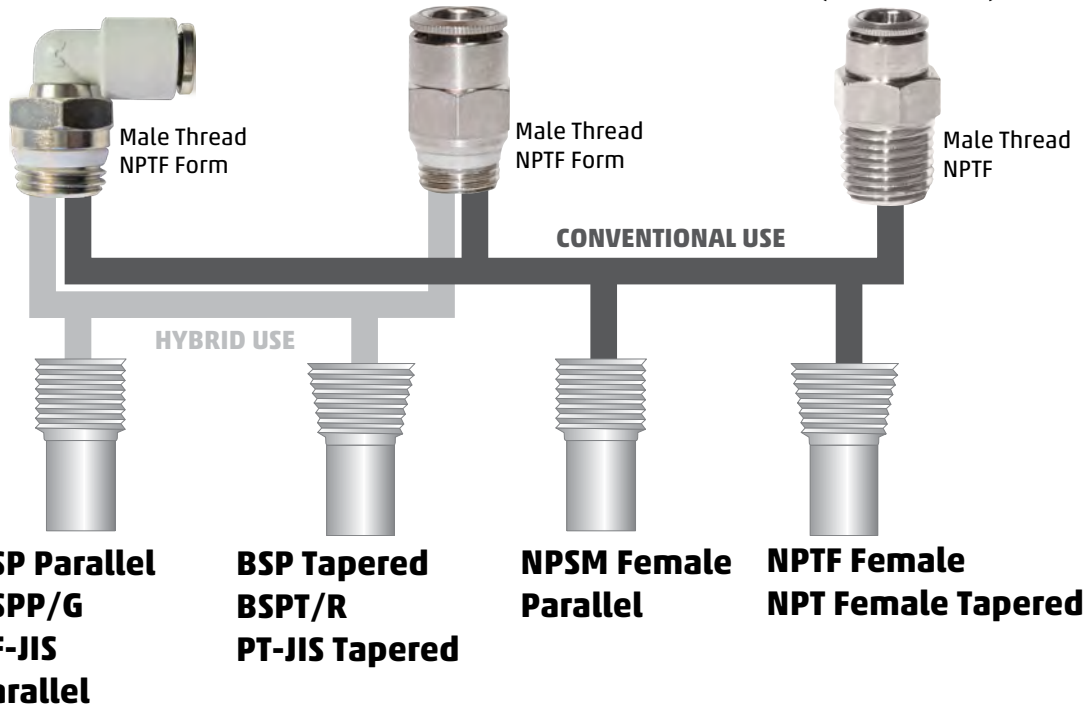

Hybrid Use:

- When inch OD tube fittings require assembly in alternate BSP ports.
- Thread sizes 1/8", 1/4", and 3/8" interchange without concern for torque with Camozzi's patented *Pro-Fit* Thread sealing system.
- For 1/2" threads, use caution, and consult hybrid torque specifications below.

"Hybrid" Torque Specifications - (*Pro-Fit*® - NPTF Fittings assembled into female BSP ports)

Caution: Mating material and female ports may be too soft for high torque values. Check material hardness to avoid stripping, galling or cross-threading.

This table is ONLY a guide for "hybrid" situations that require interchanging thread types to accommodate tubing requirements.

Thread Size	Minimum Torque Value		Maximum Torque Value	
	Nm	Ft-Lbs	Nm	Ft-Lbs
<i>Pro-Fit</i>				
1/8" *	1.0	0.7	10.0	7.4
1/4" *	4.0	2.9	20.0	14.8
3/8" *	5.0	3.7	20.0	14.8
1/2"	27.0	20.0	54.0	40.0

* Hybrid torque values for these thread sizes are equal to the torque values for conventional use (NPTF male to NPTF female).

BSP/METRIC Thread Assembly & Interchange

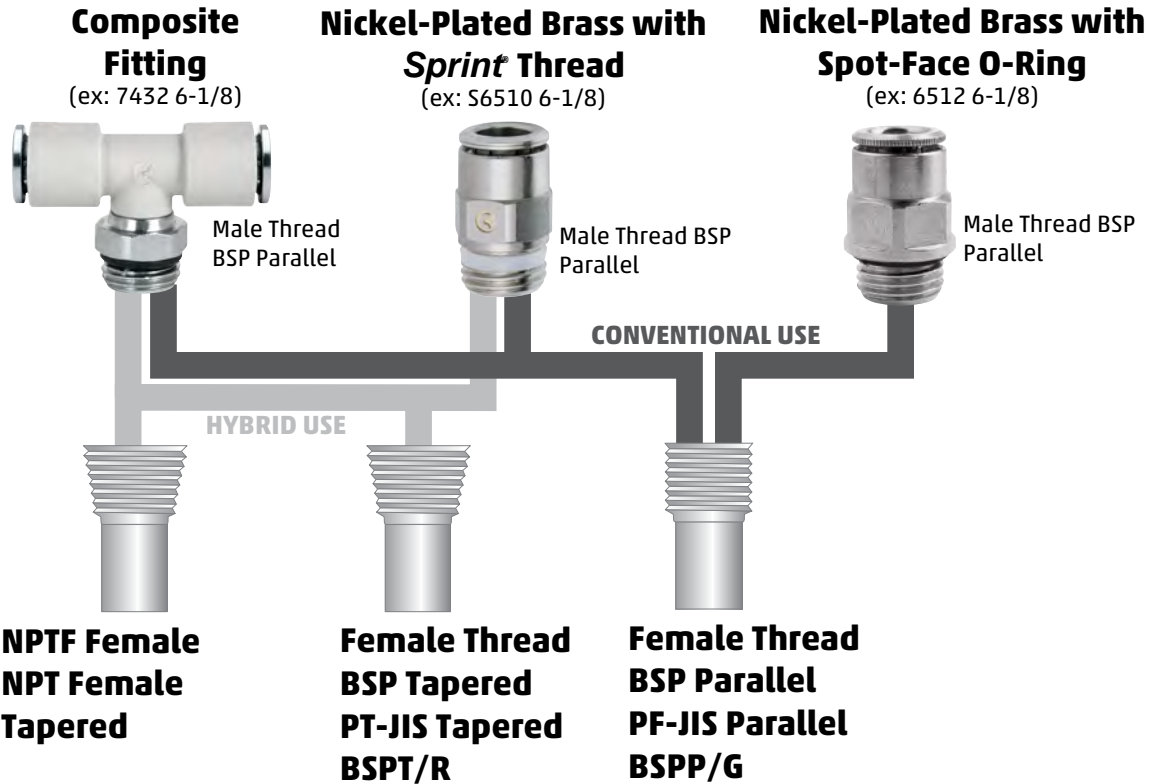

Hybrid Use:

- When metric tube fittings require assembly in alternate NPTF ports.
- Thread sizes 1/8" and 1/4" interchange without concern for torque with Camozzi's patented Sprint and Compact sealing system.
- For 3/8" and 1/2" threads, use caution, and consult hybrid torque specifications below.

"Hybrid" Torque Specifications - (Sprint - BSP Fittings assembled into female NPTF ports)

Caution: Mating material and female ports may be too soft for high torque values.

Check material hardness to avoid stripping, galling or cross-threading.

This table is ONLY a guide for "hybrid" situations that require interchanging thread types to accommodate tubing requirements.

Thread Size	Minimum Torque Value		Maximum Torque Value	
	Nm	Ft-Lbs	Nm	Ft-Lbs
1/8" *	1.0	0.7	10.0	7.4
1/4" *	4.0	2.9	20.0	14.8
3/8"	27.0	20.0	54.0	40.0
1/2"	27.0	20.0	67.0	50.0

* Hybrid torque values for these thread sizes are equal to the torque values for conventional use (BSP male to BSP female).

Fittings Selector Guide

Fittings in NPTF/Inch and BSP/Metric Thread types, Sealing, Body configuration and Tube sizing

P6510 04-06-V

Thread Type:

 **P = Pro-Fit® Thread**

 Blank = bare NPTF threads

 **C = Coated with thread sealant, Loctite Vibra-Seal 516 (red)**

ND = D.O.T. rated fitting with low-temp seals and tube support

S = Sprint® (Metric tube and BSP threads)

Pro-Fit® Advantages:

- Short NPTF thread with PTFE sealing ring
- Eliminates the need for thread sealant
- Faster and cleaner assembly
- Installs flush with no exposed threads
- Also fits in BSPT and BSPP ports (1/8", 1/4", and 3/8")

Sprint® Advantages:

- Short BSP thread with PTFE sealing ring
- Eliminates the need for thread sealant
- Faster and cleaner assembly
- Installs flush with no exposed threads
- Also fits in NPTF ports (1/8", 1/4")

Body Style:



Tube Size

(OD):
Inch
 02 = 1/8"
 53 = 5/32"
04 = 1/4"
 05 = 5/16"
 06 = 3/8"
 08 = 1/2"
 12 = 3/4"

Metric
 3 = 3mm
 4 = 4mm
 5 = 5mm
 6 = 6mm
 8 = 8mm
 10 = 10mm
 12 = 12mm

Thread Size:

NPTF
 32 = 10-32 UNF
 02 = 1/8"
 04 = 1/4"
06 = 3/8"
 08 = 1/2"
 12 = 3/4"

BSP
 M5 = M5
 M7 = M7
 1/8 = G1/8
 1/4 = G1/4
 3/8 = G3/8
 1/2 = G1/2

Seal Material:

(optional)
 Blank = Standard
V = Viton
 EPDM = EPDM
 -50C = Low temp
 NBR

Other sizes and shapes, including composite bodies, are also available.

Nickel-Plated Brass Push-In Fittings Series 6000

Tube Diameter OD : 1/8", 5/32", 1/4", 5/16", 3/8", 1/2", 3/4", 1", 1 1/4", 1 1/2", 2", 2 1/2", 3", 4", 5", 6", 8", 10", 12", 14 or 16 mm
 Thread Type : 10-32 UNF, 1/8", 1/4", 3/8", 1/2", 3/4" NPTF, BSP, Pro-Fit®, or Sprint®
 (Reusable PTFE/Teflon thread seal)

PUSH-IN FITTINGS



Camozzi's all metal fittings are 100% electrolytic nickel-plated brass. Full ID tube flow is always maintained for maximum Cv ratings and quick cycle times. "Push-in" and lock the tube quickly and effortlessly.

Connection and disconnection of the tube can be repeated several times and can be performed using one hand and without the use of tools.

Fittings also available in coated thread sealant, Loctite Vibra-Seal 516 (use "C" prefix in part code, see tables for available models).

Pro-Fit® and Sprint® Torque Specifications

Thread Size	Minimum Torque		Maximum Torque	
	N-m	lb-ft	N-m	lb-ft
M5 [10-32 UNF]	0.400	0.295	2.000	1.475
1/8 NPTF or BSP	2.000	1.475	10.000	7.376
1/4 NPTF or BSP	4.000	2.950	20.000	14.751
3/8 NPTF or BSP	5.000	3.688	20.000	14.751
1/2 NPTF or BSP	8.000	5.900	40.000	29.502

GENERAL DATA

Material	Body and collet: nickel-plated brass, (UNI 5705 OT58) O-Ring: NBR (standard); Viton and EPDM available on request thread seal: PTFE - NBR - PA; Loctite Vibra-Seal 516 (red)
Threads	10-32 UNF, 1/8", 1/4", 3/8", 1/2" NPTF, Pro-Fit® M3 - M5 - M7 - G1/8 - G1/4 - G3/8 - G1/2 - G3/4, Sprint®, GAS conical ISO 7 (BSPT), GAS cylindrical ISO 228 (BSP) *M5-M6 and other metric threads available on request
Pressure	min -0.9 bar - max 16 bar (28" Hg vacuum to 250 psi) (see tubing)
Tube to connect	Nylon 6, 11 or 12, polyethylene, PU, (Polyurethane recommended 90A durometer and above) Hytrel Polyester
Tube Diameters OD	Inch tubing: 1/8" - 5/32" - 1/4" - 5/16" - 3/8" - 1/2" Metric tubing: Ø 3 - 4 - 5 - 6 - 8 - 10 - 12 - 14 - 16 mm
Fluid	compressed air (for other types of fluid, contact our engineers)
Temperature	-20°C - 80°C, -4 F to 175 F (see data for tubing used) Micro: -10°C - 80°C (14 F to 175 F) (see data for tubing used)

Fitting with connecting tube

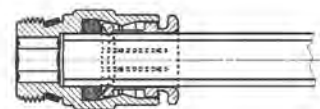
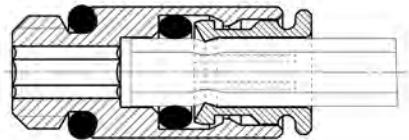

Nickel-Plated Brass Push-In Fittings Series 6000

Pro-Fit® Style NPTF Thread

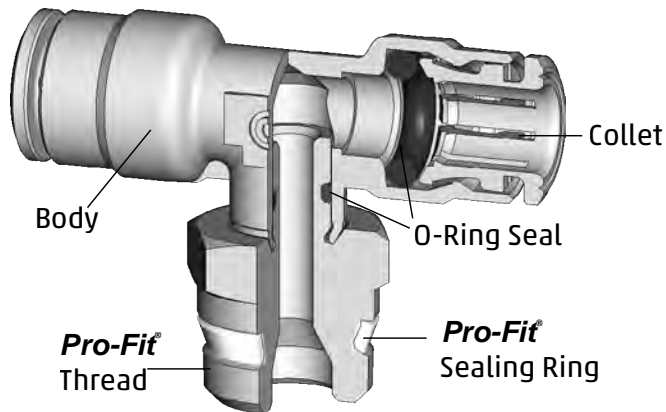

Standard NPTF & NPTF Coated Thread

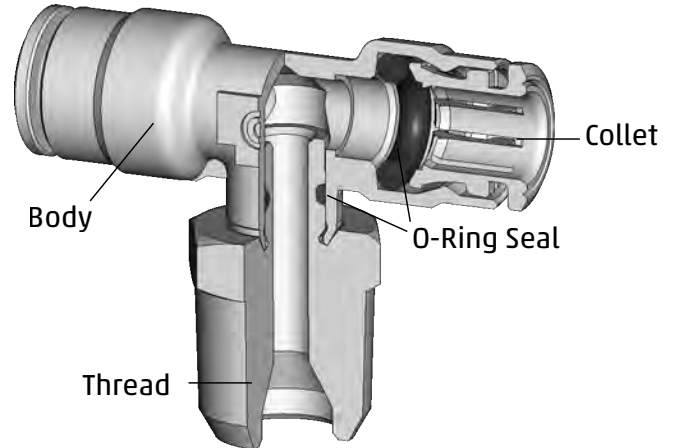

Features

Collet

- Nickel-Plated, All-metal Collet and Release ring
- Collet design offers greater grip strength under higher pressure or tubing tension
- Collet release mechanism based on relaxed slope of grip teeth, as opposed to disengaging "bite-rings" from partially cut tubes
- Removable Collet and tube o-rings

Body

- All-Metal, Nickel-Plated body and Threads
- Compact Brass bodies from Brass forgings
- Standard Buna-N or Specialized O-ring choices for High-Temp, Low-Temp, Special Fluids, Food-Grade compatibility
- Broad Range of shapes and configurations
- Crimp design on Swivels maintains Full ID Flow path
- Swivels offer Mechanical crimping lock based on cold-forged brass and not spin-swaged or "thinned" brass
- Full ID Flow for Swivels and Straights, with high relief on larger sizes
- Internal Hex on Straight fittings

Pro-Fit® Thread Design

- Low Profile Fit
- Fast Installation
- Perfect Reusable Seal

Benefits

Collet

- Won't break like plastic release rings and bodies; More Durable design
- Higher holding force, with easier release
- Won't scratch tubes like "bite-ring" designs
- Less chance of micro-leakage and bubble-leaks over time due to damaged tubing
- Higher pressures actually offer greater grip-strength with high-pressure Nylon tubing
- OD Tube Size stamped on Collet face

Body

- Resistant to UV exposure
- Better resistance to stress-cracking, abrasion, solvents, detergents, hydrocarbons and other fluid media
- FDA/NSF approved materials, (Including customized Nickel-Plating and o-ring options) available on request
- Simplified manifold circuits with broader variety of fitting combinations and shapes to select
- Lighter weight for End-of-Arm tooling & Robotic handling,
- Compact design reduces overall dimensions for valve assemblies, packaging applications and control cabinets
- 12% Reduction in overall Body size, compared to previous Brass line
- Full ID Flow and high relief undercuts offers greatest flow without restriction to circuit design flow calculations

Pro-Fit® Thread Design

- Eliminates exposed threads and fits into tight spaces, making them ideal for food processing and hygienic applications.
- Eliminates the need for Teflon® tape or pipe dope. Shorter thread length requires fewer turns to tighten.
- The captured Teflon® sealing ring provides a dependable and reusable shoulder seal without the risk of thread sealant contamination.

Fittings Model P6510 and S6510...

Pro-Fit® or Sprint® Male Connector

INCH Tube Fittings

DIMENSIONS (in inches)

Model	A OD	D NPTF	C	F	G	H	L	SW	SW1
P6510 02-02	1/8	1/8	0.177	0.346	0.551	0.197	0.728	0.472	0.098
P6510 02-04	1/8	1/4	0.256	0.346	0.630	0.256	0.807	0.551	0.098
P6510 53-02	5/32	1/8	0.177	0.346	0.551	0.197	0.728	0.472	0.098
P6510 53-04	5/32	1/4	0.256	0.346	0.630	0.256	0.807	0.551	0.098
P6510 04-02	1/4	1/8	0.189	0.461	0.551	0.197	0.827	0.472	0.157
P6510 04-04	1/4	1/4	0.228	0.461	0.630	0.256	0.866	0.551	0.157
P6510 04-06	1/4	3/8	0.268	0.461	0.866	0.295	0.906	0.748	0.157
P6510 05-02	5/16	1/8	0.276	0.539	0.630	0.197	0.965	0.551	0.197
P6510 05-04	5/16	1/4	0.276	0.539	0.630	0.256	0.965	0.551	0.236
P6510 05-06	5/16	3/8	0.256	0.539	0.866	0.295	0.945	0.748	0.236
P6510 06-02	3/8	1/8	0.315	0.606	0.776	0.197	1.102	0.669	0.197
P6510 06-04	3/8	1/4	0.335	0.606	0.776	0.256	1.122	0.669	0.276
P6510 06-06	3/8	3/8	0.177	0.606	0.866	0.295	0.965	0.748	0.276
P6510 06-08	3/8	1/2	0.217	0.606	1.004	0.335	1.004	0.866	0.276
P6510 08-04	1/2	1/4	0.346	0.720	0.866	0.256	1.102	0.748	0.276
P6510 08-06	1/2	3/8	0.346	0.720	0.866	0.295	1.102	0.748	0.394
P6510 08-08	1/2	1/2	0.248	0.720	1.004	0.335	1.004	0.866	0.394

METRIC Tube Fittings

DIMENSIONS (in mm)

Model	A	D	C	F	G	H	L	SW	SW1	Weight (g)
S6510 4-1/8	4	G1/8	3.8	8.8	13.2	5.5	18	12	2.5	9
S6510 4-1/4	4	G1/4	5.5	8.8	15.2	7	19.5	14	2.5	15
S6510 5-1/8	5	G1/8	3.8	9.8	13.2	5.5	19	12	3	8
S6510 5-1/4	5	G1/4	5.5	9.8	15.2	7	20	14	3	14
S6510 6-1/8	6	G1/8	6	11.7	13.2	5.5	22	12	4	10
S6510 6-1/4	6	G1/4	5.5	11.7	15.2	7	21	14	4	14
S6510 6-3/8	6	G3/8	6.5	11.7	20.5	8	22.5	19	4	27
S6510 8-1/8	8	G1/8	7.5	13.7	15.2	5.5	25	14	5	13
S6510 8-1/4	8	G1/4	6.5	13.7	15.2	7	24	14	6	14
S6510 8-3/8	8	G3/8	6	13.7	20.5	8	23.5	19	6	25
S6510 8-1/2	8	G1/2	7.5	13.7	24.5	9	25	22	6	43
S6510 10-1/4	10	G1/4	8.3	15.4	18.5	7	28.5	17	7	23
S6510 10-3/8	10	G3/8	5.3	15.4	20.5	8	25.5	19	8	27
S6510 10-1/2	10	G1/2	4.8	16	24.5	9	25	22	8	39
S6510 12-1/4	12	G1/4	10.3	18.3	20.5	7	29.5	19	7	26
S6510 12-3/8	12	G3/8	9.3	18.3	20.5	8	28.5	19	9	30
S6510 12-1/2	12	G1/2	5.8	18.3	24.5	9	25	22	10	36
S6510 14-3/8	14	G3/8	10.3	20.5	24.5	8	30.5	22	9	42
S6510 14-1/2	14	G1/2	6.3	20.5	24.5	9	26.5	22	12	34
S6510 16-1/2	16	G1/2	9	23.5	26.5	9	32	24	-	42
S6510 16-3/4	16	G3/4	3.5	23.5	27.3	9	26.5	24	-	46

Micro Fitting Model P6510

Pro-Fit® Micro Barrel Connector

INCH TUBING

DIMENSIONS (in inches)

Model	A OD	D NPTF	F	H	L	SW
P6510 04-02-M	1/4	1/8	.425	.197	.866	.157

INCH Tube Fittings



P6510

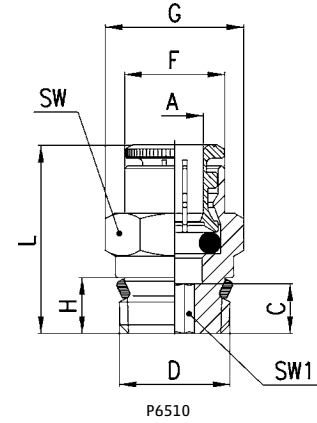

METRIC Tube Fittings



S6510

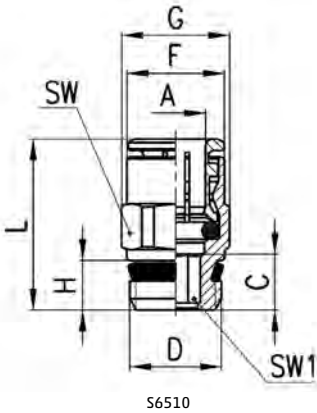

INCH Tube Fittings



P6510

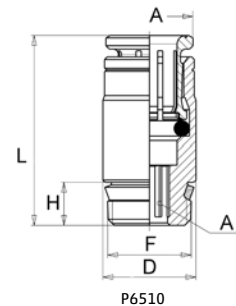

Fittings Models 6512 and 6510...

Full Thread Male Connector

INCH Tube Fittings									
DIMENSIONS (in inches)									
Model	A	D	C	F	G	H	L	SW	SW1
	OD	UNF							
6512 02-32	1/8	10-32	0.236	0.307	0.363	0.157	0.787	0.315	0.078
6512 53-32	5/32	10-32	0.236	0.307	0.363	0.157	0.787	0.315	0.078
6512 04-32	1/4	10-32	0.228	0.460	0.577	0.157	0.846	0.472	0.078
		NPTF							
6510 02-02	1/8	1/8	0.197	0.346	0.551	0.315	0.748	0.472	0.098
6510 02-04	1/8	1/4	0.354	0.346	0.630	0.472	0.906	0.551	0.098
6510 53-02	5/32	1/8	0.197	0.346	0.551	0.315	0.748	0.472	0.098
6510 53-04	5/32	1/4	0.354	0.346	0.630	0.472	0.906	0.551	0.098
6510 04-02	1/4	1/8	0.287	0.461	0.551	0.315	0.925	0.472	0.157
6510 04-04	1/4	1/4	0.406	0.461	0.630	0.472	1.043	0.551	0.157
6510 04-06	1/4	3/8	0.425	0.461	0.866	0.472	1.063	0.748	0.157
6510 05-02	5/16	1/8	0.394	0.539	0.630	0.315	1.083	0.551	0.197
6510 05-04	5/16	1/4	0.413	0.539	0.630	0.472	1.102	0.551	0.236
6510 05-06	5/16	3/8	0.413	0.539	0.866	0.472	1.102	0.748	0.236
6510 06-02	3/8	1/8	0.394	0.606	0.776	0.315	1.181	0.669	0.157
6510 06-04	3/8	1/4	0.551	0.606	0.776	0.472	1.339	0.669	0.276
6510 06-06	3/8	3/8	0.354	0.606	0.866	0.472	1.142	0.748	0.276
6510 06-08	3/8	1/2	0.374	0.606	1.004	0.610	1.161	0.866	0.276
6510 08-04	1/2	1/4	0.563	0.720	0.866	0.472	1.299	0.748	0.276
6510 08-06	1/2	3/8	0.484	0.720	0.866	0.472	1.240	0.748	0.394
6510 08-08	1/2	1/2	0.425	0.720	1.004	0.610	1.181	0.866	0.394

*add 'C' for sealant coated fittings (e.g. 6510 02-02 becomes C6510 02-02)

INCH Tube Fittings



6512

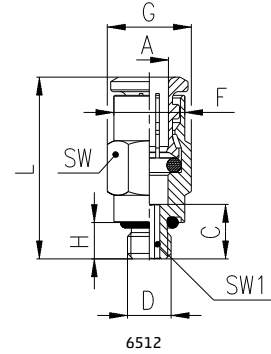

6512



6510

= with O-Ring



C6510

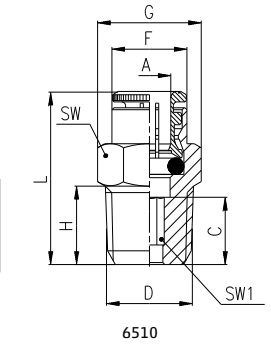

6510

METRIC Tube Fittings										
DIMENSIONS (in mm)										
Model	A	D	C	F	G	H	L	SW	SW1	Weight (g)
6512 4-M5	4	M5	6	7.8	8.8	4	20	8	2	4
6512 4-M6	4	M6	6.5	8.8	9.9	4.5	20.5	9	2.5	6
6512 4-1/8	4	G1/8	5	8.8	13.5	6	19	12	2.5	10
6512 4-1/4	4	G1/4	6.5	8.8	16.4	7	20.5	15	2.5	14
6512 5-M5	5	M5	6	8.8	9.9	4	21	9	2	5
6512 6-M5	6	M5	6	11.7	13.2	4	22	12	2	8
6512 6-M6	6	M6	6.5	11.7	13.2	4.5	22.5	12	2.5	8
6512 6-1/8	6	G1/8	5	11.7	13.5	6	21	12	4	10
6512 6-1/4	6	G1/4	6	11.7	16.4	7	22	15	4	13
6512 8-1/8	8	G1/8	8.5	13.7	15.2	6	26	14	5	15
6512 8-1/4	8	G1/4	7	13.7	16.4	7	24.5	15	6	17
6512 8-3/8	8	G3/8	6.5	13.7	20.5	7	23	19	6	27
6512 10-1/4	10	G1/4	9.8	15.4	18.5	7	30	17	7	26
6512 10-3/8	10	G3/8	5.3	15.4	20.5	7	24.5	19	8	27
6512 10-1/2	10	G1/2	20.2	15.4	24.8	8	25	22	8	39
6512 12-1/4	12	G1/4	10.5	18.3	20.5	7	29.5	19	7	29
6512 12-3/8	12	G3/8	5.8	18.3	20.5	7	24	19	9	24
6512 12-1/2	12	G1/2	19.2	18.3	24.8	8	24.5	22	9	37
6512 14-3/8	14	G3/8	20.2	20.5	24.5	7	30.5	22	10	38
6512 14-1/2	14	G1/2	20.2	20.5	24.8	8	25.5	22	10	35
6512 16-1/2	16	G1/2	23.0	23.5	26.5	8	33.5	24	-	49

METRIC Tube Fittings



6512

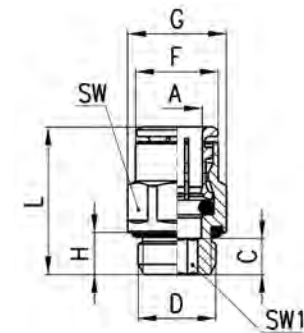

6512

Fittings Model 6512 Micro

Micro Barrel Connector

INCH Tube Fittings

DIMENSIONS (in inches)

Model	A OD	D	F	H	L	SW
6512 02-32-M	1/8	10-32 UNF	0.307	0.157	0.630	0.079
6512 04-32-M	1/4	10-32 UNF	0.409	0.157	0.669	0.079
6512 04-M5-M	1/4	M5	0.409	0.157	0.669	0.079
6512 04-M7-M	1/4	M7	0.413	0.197	0.669	0.157

METRIC Tube Fittings

DIMENSIONS (in mm)

Model	A	D	F	H	L	SW1	Weight (g)
6512 3-M3	3	M3	5.8	2.5	10.2	1.5	1
6512 3-M5	3	M5	5.8	3.5	10	2	1
6512 4-M7-M	4	M7	9.4	5	17.5	2.5	5
6512 4-1/8-M	4	G1/8	11.2	5	13	2.5	9
6512 6-M7-M	6	M7	10.4	5	17	4	7
6512 6-1/8-M	6	G1/8	11.2	5	14	4	7
6512 8-1/8-M	8	G1/8	12.4	5	18.5	5	10
6512 10-1/4-M	10	G1/4	14.8	6	21	7	16

INCH Tube Fittings

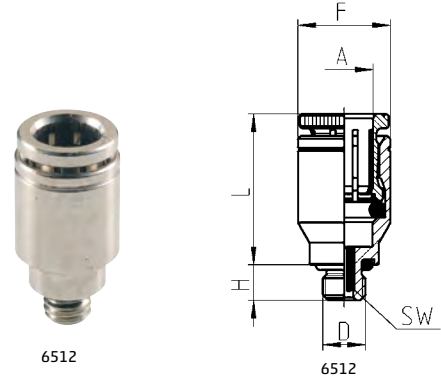

METRIC Tube Fittings

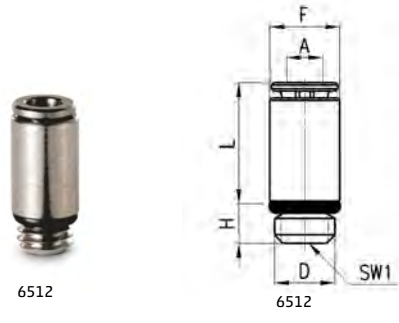

Fittings Model 6110 and Model S6110

45° Swivel Elbow

INCH Tube Fittings

DIMENSIONS (in inches)

Model	A OD	D NPTF	E	F	H	L	M	SW	SW1
6110 04-02	1/4	1/8	0.630	0.500	0.315	1.555	0.827	0.433	0.472
6110 04-04	1/4	1/4	0.748	0.500	0.472	1.713	0.827	0.433	0.551
6110 06-04	3/8	1/4	0.847	0.650	0.472	1.969	1.043	0.591	0.669
6110 06-06	3/8	3/8	0.748	0.650	0.472	1.969	1.043	0.591	0.748

*add 'C' for sealant coated fittings (e.g. 6110 04-02 becomes C6110 04-02)

METRIC Tube Fittings

DIMENSIONS (in mm)

Model	A	D	E	F	H	L	M	SW	SW1	Weight (g)
S6110 6-1/8	6	G1/8	14	12.7	5.5	32.5	20.5	11	12	21
S6110 6-1/4	6	G1/4	14	12.7	7	34.5	20.5	11	14	25
S6110 8-1/8	8	G1/8	14	14.2	5.5	32.5	22.5	11	12	21
S6110 8-1/4	8	G1/4	14	14.2	7	34.5	22.5	11	14	26
S6110 8-3/8	8	G3/8	14.5	14.2	8	35	22.5	11	19	38
S6110 10-1/4	10	G1/4	15.5	16.5	7	39.5	26.5	15	17	39
S6110 10-3/8	10	G3/8	15.5	16.5	8	39.5	26.5	15	19	44
S6110 10-1/2	10	G1/2	16	16.5	9	40	26.5	15	22	57
S6110 12-1/4	12	G1/4	15.5	19.5	7	40.5	26.5	15	17	41
S6110 12-3/8	12	G3/8	15.5	19.5	8	40.5	26.5	15	19	46
S6110 12-1/2	12	G1/2	16	19.5	9	41	26.5	15	22	59

INCH Tube Fittings

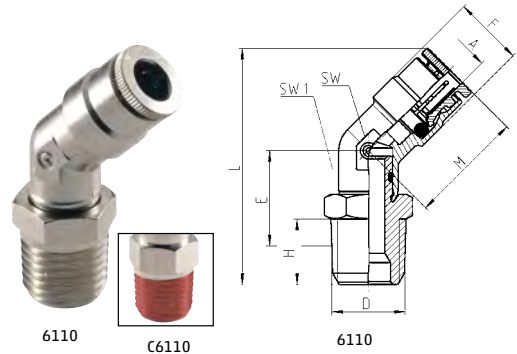

METRIC Tube Fittings

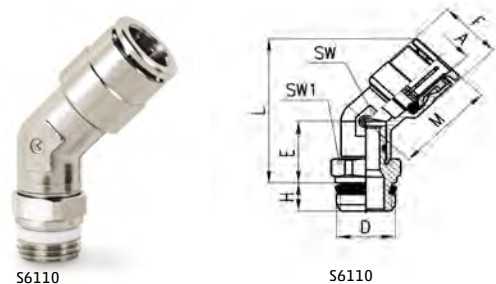

Fittings Model P6520 and S6520...

Pro-Fit® or Sprint® Male Elbow Swivel

INCH Tube Fittings

DIMENSIONS (in inches)

Model	A OD	D NPTF	C	E	F	H	M	SW	SW1
P6520 02-02	1/8	1/8	0.138	0.591	0.354	0.197	0.689	0.315	0.472
P6520 02-04	1/8	1/4	0.138	0.630	0.354	0.256	0.689	0.315	0.551
P6520 53-02	5/32	1/8	0.138	0.591	0.354	0.197	0.689	0.315	0.472
P6520 53-04	5/32	1/4	0.138	0.630	0.354	0.256	0.689	0.315	0.551
P6520 04-02	1/4	1/8	0.157	0.630	0.500	0.197	0.787	0.354	0.472
P6520 04-04	1/4	1/4	0.157	0.650	0.500	0.256	0.787	0.354	0.551
P6520 04-06	1/4	3/8	0.157	0.650	0.500	0.295	0.787	0.354	0.748
P6520 05-02	5/16	1/8	0.197	0.650	0.559	0.197	0.886	0.433	0.472
P6520 05-04	5/16	1/4	0.197	0.689	0.559	0.256	0.886	0.433	0.551
P6520 05-06	5/16	3/8	0.197	0.689	0.559	0.295	0.886	0.433	0.748
P6520 06-02	3/8	1/8	0.256	0.748	0.650	0.197	1.043	0.512	0.551
P6520 06-04	3/8	1/4	0.236	0.768	0.650	0.256	1.024	0.512	0.551
P6520 06-06	3/8	3/8	0.236	0.768	0.650	0.295	1.024	0.512	0.748
P6520 06-08	3/8	1/2	0.236	0.787	0.650	0.335	1.024	0.512	0.866
P6520 08-04	1/2	1/4	0.280	0.807	0.768	0.256	1.043	0.591	0.669
P6520 08-06	1/2	3/8	0.280	0.807	0.768	0.295	1.043	0.591	0.748
P6520 08-08	1/2	1/2	0.315	0.827	0.768	0.335	1.043	0.591	0.866

METRIC Tube Fittings

DIMENSIONS (in mm)

Model	A	D	C	E	F	H	M	SW	SW1	Weight (g)
S6520 4-1/8	4	G1/8	3.5	14.5	9	5.5	17.5	8	12	17
S6520 4-1/4	4	G1/4	3.5	14.5	9	7	17.5	8	14	23
S6520 5-1/8	5	G1/8	5.5	14.5	10	5.5	20.5	9	12	17
S6520 5-1/4	5	G1/4	5.5	14.5	10	7	20.5	9	14	23
S6520 6-1/8	6	G1/8	4	15	12.7	5.5	20	9	12	20
S6520 6-1/4	6	G1/4	4	15	12.7	7	20	9	14	23
S6520 6-3/8	6	G3/8	4	15.5	12.7	8	20	9	19	33
S6520 8-1/8	8	G1/8	5	16	14.2	5.5	22.5	11	12	22
S6520 8-1/4	8	G1/4	5	16	14.2	7	22.5	11	14	26
S6520 8-3/8	8	G3/8	5	16.5	14.2	8	22.5	11	19	41
S6520 8-1/2	8	G1/2	5	17	14.2	9	22.5	11	22	48
S6520 10-1/4	10	G1/4	5.8	18.5	16.5	7	26	13	14	32
S6520 10-3/8	10	G3/8	5.8	19	16.5	8	26	13	19	43
S6520 10-1/2	10	G1/2	5.8	19.5	16.5	9	26	13	22	62
S6520 12-1/4	12	G1/4	7.3	20	19.5	7	26.5	15	17	49
S6520 12-3/8	12	G3/8	7.3	20	19.5	8	26.5	15	19	48
S6520 12-1/2	12	G1/2	7.3	20.5	19.5	9	26.5	15	22	70
S6520 14-3/8	14	G3/8	8.3	21	21.5	8	28.5	17	19	74
S6520 14-1/2	14	G1/2	8.3	21.5	21.5	9	28.5	17	22	78

INCH Tube Fittings

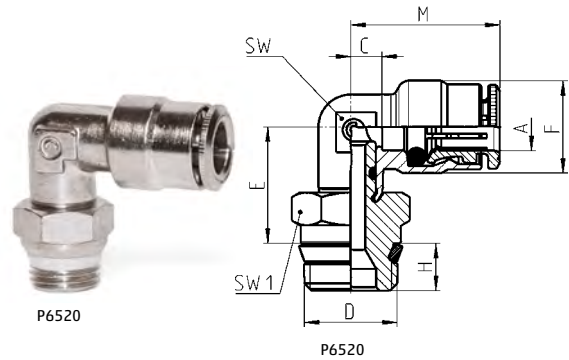

METRIC Tube Fittings

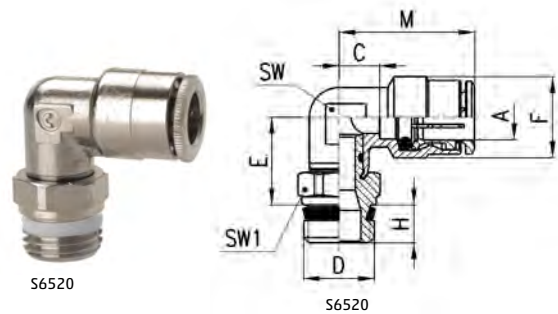

Fittings Models 6522 and 6520...

Full Thread Male Elbow Swivel

INCH Tube Fittings

DIMENSIONS (in inches)

Model	A OD	D UNF	C	E	F	H	M	SW	SW1
6522 02-32	1/8	10-32	0.138	0.492	0.354	0.157	0.689	0.315	0.315
6522 53-32	5/32	10-32	0.138	0.492	0.354	0.157	0.689	0.315	0.315
6522 04-32	1/4	10-32	0.157	0.531	0.500	0.157	0.787	0.354	0.394
NPTF									
6520 02-02	1/8	1/8	0.138	0.650	0.354	0.315	0.689	0.315	0.472
6520 02-04	1/8	1/4	0.138	0.689	0.354	0.472	0.689	0.315	0.551
6520 53-02	5/32	1/8	0.138	0.650	0.354	0.315	0.689	0.315	0.472
6520 53-04	5/32	1/4	0.138	0.689	0.354	0.472	0.689	0.315	0.551
6520 04-02	1/4	1/8	0.157	0.669	0.500	0.315	0.787	0.354	0.472
6520 04-04	1/4	1/4	0.157	0.709	0.500	0.472	0.787	0.354	0.551
6520 04-06	1/4	3/8	0.157	0.689	0.500	0.472	0.787	0.354	0.748
6520 05-02	5/16	1/8	0.197	0.709	0.559	0.315	0.886	0.433	0.472
6520 05-04	5/16	1/4	0.197	0.748	0.559	0.472	0.886	0.433	0.551
6520 05-06	5/16	3/8	0.197	0.728	0.559	0.472	0.886	0.433	0.748
6520 06-02	3/8	1/8	0.256	0.807	0.650	0.315	1.043	0.512	0.551
6520 06-04	3/8	1/4	0.236	0.846	0.650	0.472	1.024	0.512	0.551
6520 06-06	3/8	3/8	0.236	0.827	0.650	0.472	1.024	0.512	0.748
6520 06-08	3/8	1/2	0.236	0.906	0.650	0.610	1.024	0.512	0.866
6520 08-04	1/2	1/4	0.280	0.906	0.768	0.472	1.043	0.591	0.669
6520 08-06	1/2	3/8	0.280	0.866	0.768	0.472	1.043	0.591	0.748
6520 08-08	1/2	1/2	0.280	0.945	0.768	0.610	1.043	0.591	0.866

*add 'C' for sealant coated fittings (e.g. 6520 04-02 becomes C6520 04-02)

METRIC Tube Fittings

DIMENSIONS (in mm)

Model	A	D	C	E	F	H	M	SW	SW1	Weight (g)
6522 4-M5	4	M5	3.5	12.5	9	4	17.5	8	8	12
6522 4-1/8	4	G1/8	3.5	14.5	9	6	17.5	8	12	15
6522 4-1/4	4	G1/4	3.5	15.5	9	7	17.5	8	15	25
6522 5-M5	5	M5	5.5	12.5	10	4	20.5	9	8	13
6522 6-M5	6	M5	4	13	12.7	4	20	9	10	14
6522 6-1/8	6	G1/8	4	15	12.7	6	20	9	12	19
6522 6-1/4	6	G1/4	4	16	12.7	7	20	9	15	27
6522 8-1/8	8	G1/8	5	16	14.2	6	22.5	11	12	22
6522 8-1/4	8	G1/4	5	17	14.2	7	22.5	11	15	28
6522 8-3/8	8	G3/8	5	17	14.2	7	22.5	11	19	45
6522 10-1/4	10	G1/4	5.8	19.5	16.5	7	26	13	15	41
6522 10-3/8	10	G3/8	5.8	19.5	16.5	7	26	13	19	45
6255 10-1/2	10	G1/2	20.2	20.5	16.5	8	26	13	22	53
6522 12-1/4	12	G1/4	7.3	20	19.5	7	26.5	15	17	51
6522 12-3/8	12	G3/8	7.3	20.5	19.5	7	26.5	15	19	56
6522 12-1/2	12	G1/2	19.2	21.5	19.5	8	26.5	15	22	58
6522 14-3/8	14	G3/8	20.2	21.5	21.5	7	28.5	17	19	53
6522 14-1/2	14	G1/2	20.2	22.5	21.5	8	28.5	17	22	61

METRIC Tube Fittings

DIMENSIONS (in mm)

Model	A	D	E	H	M	SW	SW1	Weight (g)
6522 3-M3	3	M3	13.7	2.5	13.7	6	6	4
6522 3-M5	3	M5	13.7	3.5	13.7	6	8	5

INCH Tube Fittings



6522

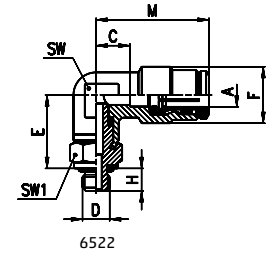

6522



6520



C6520

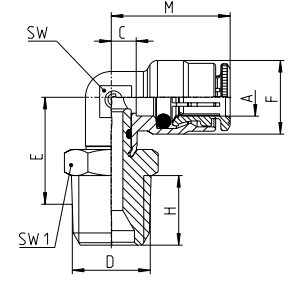

6520

= with gasket
= with O-Ring

METRIC Tube Fittings

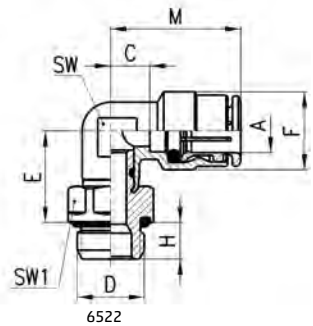

6522



6522

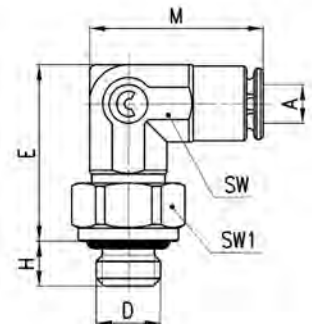

6522

= with gasket
= with O-Ring

Fittings Models P6525 and 6525

Pro-Fit® Extended Swivel Elbow

INCH Tube Fittings

DIMENSIONS (in inches)

Model	A OD	D NPTF	C	E	F	H	M	SW	SW1
P6525 53-02	5/32	1/8	0.138	1.398	0.354	0.197	0.689	0.315	0.472
P6525 53-04	5/32	1/4	0.138	1.417	0.354	0.256	0.689	0.315	0.551
P6525 04-02	1/4	1/8	0.157	1.339	0.500	0.197	0.787	0.354	0.472
P6525 04-04	1/4	1/4	0.157	1.339	0.500	0.256	0.787	0.354	0.551
P6525 04-06	1/4	3/8	0.157	1.457	0.500	0.295	0.787	0.354	0.748
P6525 06-02	3/8	1/8	0.256	1.378	0.650	0.197	1.043	0.512	0.551
P6525 06-04	3/8	1/4	0.256	1.378	0.650	0.256	1.043	0.512	0.551

METRIC Tube Fittings

DIMENSIONS (in mm)

Model	A	D	C	E	F	H	M	SW	SW1	Weight (g)
6525 6-1/8	6	G1/8	4	33.8	12.7	5.5	20	9	12	34
6525 6-1/4	6	G1/4	4	34	12.7	7	20	9	14	47
6525 8-1/8	8	G1/8	5	34.8	14.2	5.5	22.5	11	12	35
6525 8-1/4	8	G1/4	5	35	14.2	7	22.5	11	14	50

INCH Tube Fittings



P6525

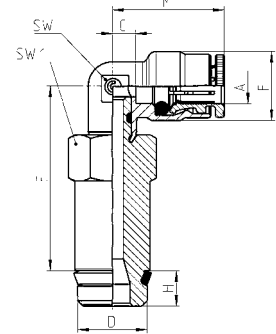

P6525

METRIC Tube Fittings



S6525

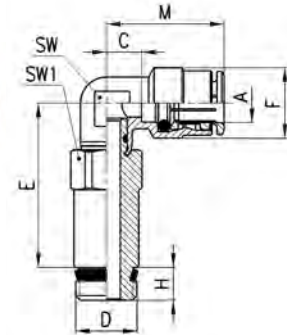

S6525

Fittings Models 6500 and S6500

Male Elbow Non-Swivel

INCH Tube Fittings

DIMENSIONS (in inches)

Model	A OD	D NPTF	C	E	F	H	M	SW
6500 04-02	1/4	1/8	0.157	0.571	0.500	0.472	0.787	0.354
6500 04-04	1/4	1/4	0.157	0.472	0.500	0.472	0.787	0.354
6500 06-04	3/8	1/4	0.236	0.551	0.650	0.472	1.024	0.512
6500 06-06	3/8	3/8	0.236	0.512	0.650	0.472	1.024	0.512

*add 'C' for sealant coated fittings (e.g. 6500 04-02 becomes C6500 04-02)

METRIC Tube Fittings

DIMENSIONS (in mm)

Model	A	D	C	E	F	H	M	SW	Weight (g)
S6500 4-1/8	4	R1/8	3.5	8.5	9	7.5	17.5	8	9
S6500 4-1/4	4	R1/4	5	11.5	9	12	19	9	13
S6500 5-1/8	5	R1/8	5.5	8.5	10	7.5	20.5	9	13
S6500 5-1/4	5	R1/4	5.5	11.5	10	12	20.5	9	17
S6500 6-1/8	6	R1/8	4	9	12.7	7.5	20	9	15
S6500 6-1/4	6	R1/4	4	11.5	12.7	12	20	9	16
S6500 8-1/8	8	R1/8	5	10.5	14.2	6.5	22.5	11	18
S6500 8-1/4	8	R1/4	5	11.5	14.2	12.5	22.5	11	21
S6500 8-3/8	8	R3/8	7	13	14.2	11.5	24.5	12	25
S6500 10-1/4	10	R1/4	5.8	13	16.5	11.5	26	13	33
S6500 10-3/8	10	R3/8	5.8	13	16.5	12	26	13	33
S6500 12-1/4	12	R1/4	7.3	14.5	19.5	11	26.5	15	46
S6500 12-3/8	12	R3/8	7.3	13.5	19.5	11.5	26.5	15	39

INCH Tube Fittings



6500



*C6500

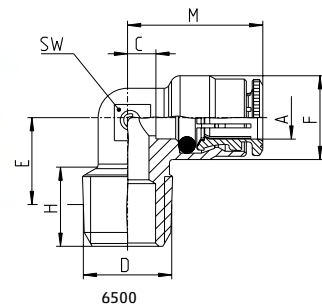

6500

METRIC Tube Fittings



S6500

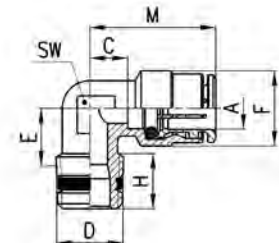

S6500

Fitting Model 6501 4-M5
Metric Non-swivel Male Elbow

METRIC Tube Fittings

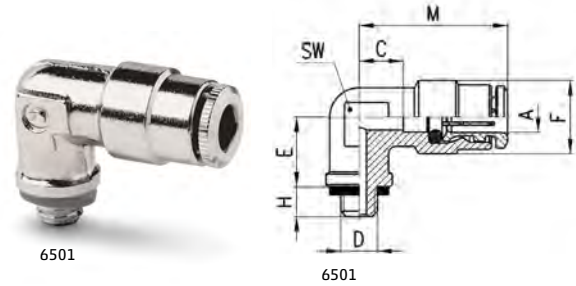

METRIC Tube Fittings									
DIMENSIONS (in mm)									
Model	A	D	C	E	F	H	M	SW	Weight (g)
6501 4-M5	4	M5	3.5	6	9	4	17.5	8	v

Fittings Model 6621 Micro
Complete Metric
Single Banjo

METRIC Tube Fittings



METRIC Tube Fittings										
DIMENSIONS (in mm)										
Model	A	B	C	F	H	L	S	W	SW	Weight (g)
6621 3-M3	3	M3	5.8	14.2	2.5	9.3	3.5	6	1.5	5
6621 3-M5	3	M5	6.5	16	3.2	11.9	4.8	8	2	6

Fittings Model 6622
Complete BSP Swivel
Single Banjo

METRIC Tube Fittings

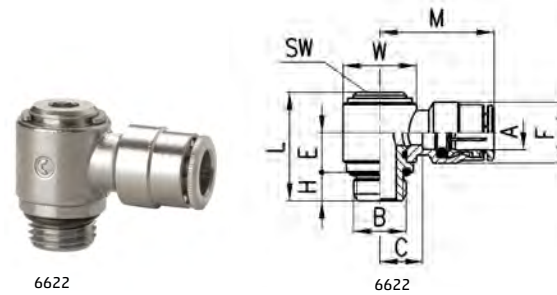

METRIC Tube Fittings											
DIMENSIONS (in mm)											
Model	A	B	C	E	F	H	L	M	SW	W	Weight (g)
6622 4-M5	4	M5	4	5.7	8.8	4	15.8	18	2.5	Ø8	10
6622 4-1/8	4	G1/8	7.5	10.2	9	5	25	21.5	4	Ø14	22
6622 6-1/8	6	G1/8	8	10.2	12.7	5	25	24	4	Ø14	24
6622 6-1/4	6	G1/4	10	9.1	12.7	6	25.3	26	5	Ø18	35
6622 8-1/8	8	G1/8	8	10.2	14.2	5	25	25.5	4	Ø14	28
6622 8-1/4	8	G1/4	10	9.1	14.2	6	25.3	27.5	5	Ø18	39
6622 10-1/4	10	G1/4	8.8	9.1	16.5	6	25.3	29	5	Ø18	42

Fittings Model 6632
Complete BSP Swivel
Double Banjo

METRIC Tube Fittings

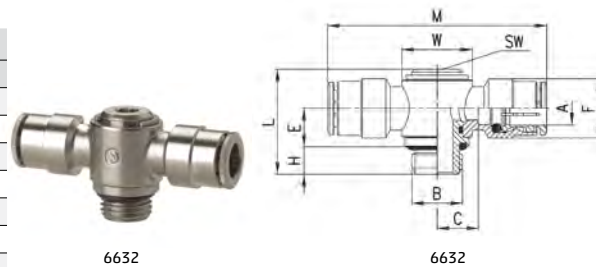

METRIC Tube Fittings											
DIMENSIONS (in mm)											
Model	A	B	C	E	F	H	L	M	W	SW	Weight (g)
6632 4-1/8	4	G1/8	7.5	10.2	9	5	25	43	Ø14	4	24
6632 6-1/8	6	G1/8	8	10.2	12.7	5	25	48	Ø14	4	33
6632 6-1/4	6	G1/4	10	9.1	12.7	6	25.3	52	Ø18	5	35
6632 8-1/8	8	G1/8	8	10.2	14.2	5	25	51	Ø14	4	39
6632 8-1/4	8	G1/4	10	9.1	14.2	6	25.3	55	Ø18	5	40
6632 10-1/4	10	G1/4	8.8	9.1	16.5	6	25.3	58	Ø18	5	50

Fittings Model P6450
Pro-Fit® or Sprint® Male "Y" Swivel

INCH Tube Fittings

DIMENSIONS (in inches)

Model	A OD	D NPTF	F	H	L	M	SW
P6450 02-02	1/8	1/8	0.709	0.197	1.299	0.354	0.472
P6450 53-02	5/32	1/8	0.709	0.197	1.299	0.354	0.472
P6450 04-02	1/4	1/8	0.965	0.197	1.437	0.492	0.472
P6450 04-04	1/4	1/4	0.965	0.256	1.457	0.492	0.551
P6450 06-04	3/8	1/4	1.260	0.256	1.969	0.630	0.551

METRIC Tube Fittings

DIMENSIONS (in mm)

Model	A	D	F	H	L	M	SW	Weight (g)
6451 4-M5	4	M5	18	4	26.5	9	-	17 *
6451 6-M5	6	M5	24.5	4	29.5	12.5	-	27 *
S6450 4-1/8	4	G1/8	18	5.5	38	9	12	23
S6450 6-1/8	6	G1/8	24.5	5.5	41.5	12.5	12	33
S6450 8-1/8	8	G1/8	28.5	5.5	48.5	14.5	14	48
S6450 8-1/4	8	G1/4	28.5	7	50	14.5	14	50



P6450

INCH Tube Fittings

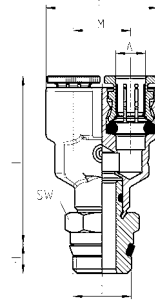

P6450

METRIC Tube Fittings

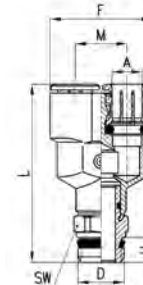

S6450

Fittings Model 6451 and Model 6450
Male "Y" Swivel

INCH Tube Fittings

DIMENSIONS (in inches)

Model	A OD	D UNF	F	H	M	L	SW
*6451 02-32	1/8	10-32	.827	.177	.354	1.063	.315
		NPTF					
6450 02-02	1/8	1/8	.827	.315	.354	1.535	.472
6450 53-02	5/32	1/8	.827	.315	.354	1.535	.472
6450 04-02	1/4	1/8	.965	.315	.492	1.673	.472

* add 'C' for sealant coated fittings (e.g. 6450 04-02 becomes C6450 04-02)



6451



6450



C6450

INCH Tube Fittings

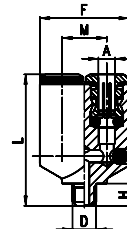

6451

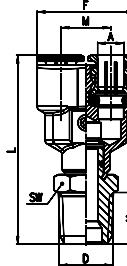

6450

* No swivel male

Fittings Model 6452 Micro
Metric Swivel Male Y

METRIC Tube Fittings

DIMENSIONS (in mm)

Model	A	D	F	H	L	M	SW	SW1	Weight (g)
6452 3-M3	3	M3	12	2.5	20.9	6	6	6	6
6452 3-M5	3	M5	12	3.5	20.9	6	6	8	7

= with gasket
= with O-Ring



6452

METRIC Tube Fittings

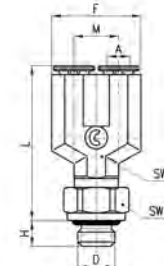

6452

Fittings Model P6430...

Pro-Fit® or Sprint® Male Branch Tee Swivel

INCH Tube Fittings

DIMENSIONS (in inches)

Model	A OD	D NPTF	C	E	F	H	L	SW	SW1
P6430 02-02	1/8	1/8	0.138	0.591	0.354	0.197	1.378	0.315	0.472
P6430 53-02	5/32	1/8	0.138	0.591	0.354	0.197	1.378	0.315	0.472
P6430 53-04	5/32	1/4	0.138	0.630	0.354	0.256	1.378	0.315	0.551
P6430 04-02	1/4	1/8	0.157	0.630	0.500	0.197	1.575	0.354	0.472
P6430 04-04	1/4	1/4	0.157	0.650	0.500	0.256	1.575	0.354	0.551
P6430 04-06	1/4	3/8	0.157	0.650	0.500	0.295	1.575	0.354	0.748
P6430 06-04	3/8	1/4	0.236	0.768	0.650	0.256	2.047	0.512	0.551
P6430 06-06	3/8	3/8	0.236	0.768	0.650	0.295	2.047	0.512	0.748
P6430 06-08	3/8	1/2	0.256	0.787	0.650	0.335	2.087	0.512	0.866
P6430 08-04	1/2	1/4	0.280	0.807	0.768	0.256	2.087	0.591	0.669
P6430 08-06	1/2	3/8	0.280	0.807	0.768	0.295	2.087	0.591	0.748
P6430 08-08	1/2	1/2	0.280	0.827	0.768	0.335	2.087	0.591	0.866

METRIC Tube Fittings

DIMENSIONS (in mm)

Model	A	D	C	E	F	H	L	SW	SW1	Weight (g)
S6430 4-1/8	4	G1/8	3.5	14.5	9	5.5	35	8	12	18
S6430 5-1/8	5	G1/8	5.5	14.5	10	5.5	41	9	12	24
S6430 5-1/4	5	G1/4	5.5	14.5	10	7	41	9	14	30
S6430 6-1/8	6	G1/8	4	15	12.7	5.5	40	9	12	28
S6430 6-1/4	6	G1/4	4	15	12.7	7	40	9	14	33
S6430 8-1/8	8	G1/8	5	16	14.2	5.5	45	11	12	37
S6430 8-1/4	8	G1/4	5	16	14.2	7	45	11	14	42
S6430 8-3/8	8	G3/8	5	16.5	14.2	8	45	11	19	51
S6430 10-1/4	10	G1/4	5.8	18.5	16.5	7	52	13	14	56
S6430 10-3/8	10	G3/8	5.8	19	16.5	8	52	13	19	67
S6430 10-1/2	10	G1/2	5.8	19.5	16.5	9	52	13	22	85
S6430 12-1/4	12	G1/4	7.3	20	19.5	7	53	15	17	60
S6430 12-3/8	12	G3/8	7.3	20	19.5	8	53	15	19	65
S6430 12-1/2	12	G1/2	7.3	20.5	19.5	9	53	15	22	89
S6430 14-1/2	14	G1/2	8.3	21.5	21.5	9	57	17	22	88

INCH Tube Fittings

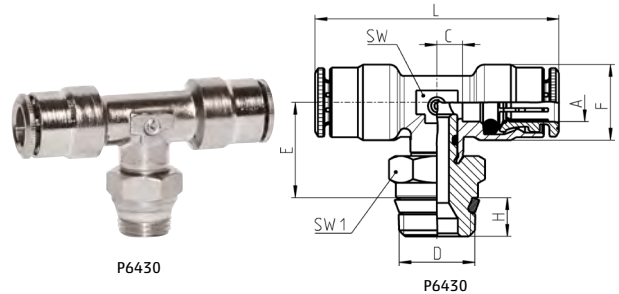

METRIC Tube Fittings

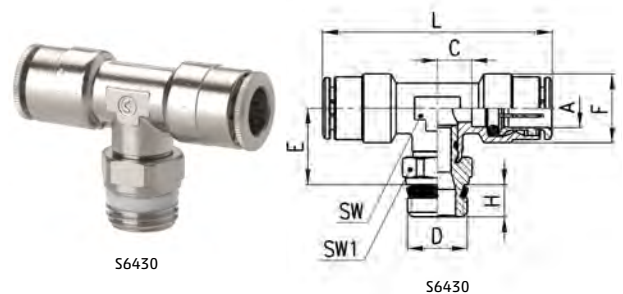

Fittings Model 6432 and Model 6430...

Male Branch Tee Swivel

INCH Tube Fittings

DIMENSIONS (in inches)

Model	A	D	C	E	F	H	L	SW	SW1	
		OD	UNF							
6432 02-32	1/8	10-32	0.138	0.492	0.354	0.157	1.378	0.315	0.315	
6432 53-32	5/32	10-32	0.138	0.492	0.354	0.157	1.378	0.315	0.315	
		NPTF								
6430 02-02	1/8	1/8	0.138	0.650	-	0.315	1.378	0.315	0.472	
6430 53-02	5/32	1/8	0.138	0.650	-	0.315	1.378	0.315	0.472	
6430 53-04	5/32	1/4	0.138	0.689	-	0.472	1.378	0.315	0.551	
6430 04-02	1/4	1/8	0.157	0.669	0.500	0.315	1.575	0.354	0.472	
6430 04-04	1/4	1/4	0.157	0.709	0.500	0.472	1.575	0.354	0.551	
6430 04-06	1/4	3/8	0.157	0.689	0.500	0.472	1.575	0.354	0.748	
6430 06-04	3/8	1/4	0.236	0.846	-	0.472	2.047	0.512	0.551	
6430 06-06	3/8	3/8	0.236	0.827	-	0.472	2.047	0.512	0.748	
6430 06-08	3/8	1/2	0.256	0.906	-	0.610	2.087	0.512	0.866	
6430 08-04	1/2	1/4	0.280	0.906	0.768	0.472	2.087	0.591	0.669	
6430 08-06	1/2	3/8	0.280	0.866	0.768	0.472	2.087	0.591	0.748	
6430 08-08	1/2	1/2	0.280	0.945	0.768	0.610	2.087	0.591	0.866	

METRIC Tube Fittings

DIMENSIONS (in mm)

Model	A	D	C	E	F	H	L	SW	SW1	Weight (g)
6432 4-M5	4	M5	3.5	12.5	9	4	35	8	8	14
6432 4-1/8	4	G1/8	3.5	14.5	9	6	35	8	12	19
6432 5-M5	5	M5	5.5	12.5	10	4	41	9	8	19
6432 6-1/8	6	G1/8	4	15	12.7	6	40	9	12	29
6432 6-1/4	6	G1/4	4	16	12.7	7	40	9	15	30
6432 8-1/8	8	G1/8	5	16	14.2	6	45	11	12	37
6432 8-1/4	8	G1/4	5	17	14.2	7	45	11	15	39
6432 8-3/8	8	G3/8	5	17	14.2	7	45	11	19	55
6432 10-1/4	10	G1/4	5.8	19.5	16.5	7	52	13	15	59
6432 10-3/8	10	G3/8	5.8	19.5	16.5	7	52	13	19	56
6432 12-1/4	12	G1/4	7.3	20	19.5	7	53	15	17	60
6432 12-3/8	12	G3/8	7.3	20.5	19.5	7	53	15	19	80

INCH Tube Fittings



6432

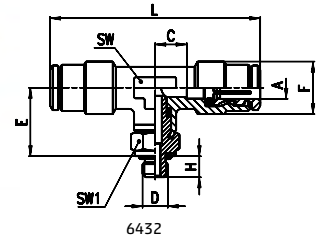

6430



C6430

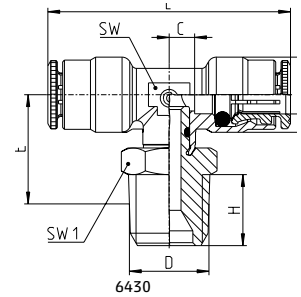

6430

METRIC Tube Fittings



6432

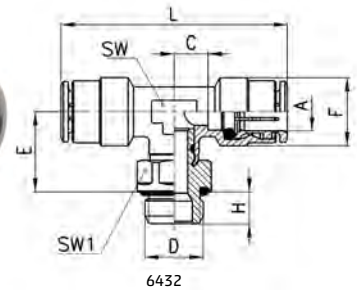

6432

Fittings Model P6440...
Pro-Fit® or Sprint® Male Run Tee Swivel

INCH Tube Fittings

DIMENSIONS (in inches)

Model	A OD	D NPTF	C	E	F	H	L	M	SW	SW1
P6440 02-02	1/8	1/8	0.138	0.591	0.354	0.197	1.476	0.689	0.315	0.472
P6440 53-02	5/32	1/8	0.138	0.591	0.354	0.197	1.476	0.689	0.315	0.472
P6440 53-04	5/32	1/4	0.138	0.630	0.354	0.256	1.575	0.689	0.315	0.551
P6440 04-02	1/4	1/8	0.157	0.630	0.500	0.197	1.614	0.787	0.354	0.472
P6440 04-04	1/4	1/4	0.157	0.650	0.500	0.256	1.693	0.787	0.354	0.551
P6440 04-06	1/4	3/8	0.157	0.650	0.500	0.295	1.732	0.787	0.354	0.748
P6440 06-04	3/8	1/4	0.256	0.768	0.650	0.256	2.067	1.024	0.512	0.551
P6440 06-06	3/8	3/8	0.256	0.768	0.650	0.295	2.106	1.024	0.512	0.748
P6440 06-08	3/8	1/2	0.256	0.787	0.650	0.335	2.165	1.043	0.512	0.866
P6440 08-04	1/2	1/4	0.315	0.807	0.768	0.256	2.106	1.043	0.591	0.669
P6440 08-06	1/2	3/8	0.315	0.807	0.768	0.295	2.146	1.043	0.591	0.748
P6440 08-08	1/2	1/2	0.315	0.827	0.768	0.335	2.205	1.043	0.591	0.866

INCH Tube Fittings

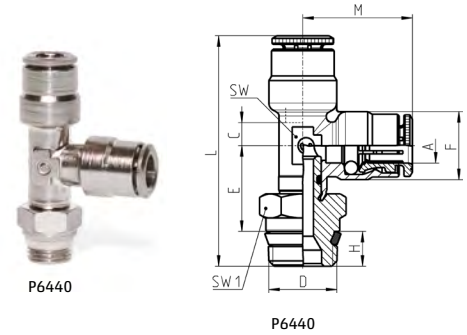

P6440

P6440

METRIC Tube Fittings

DIMENSIONS (in mm)

Model	A	D	C	E	F	H	L	M	SW	SW1	Weight (g)
S6440 4-1/8	4	G1/8	3.5	14.5	9	5.5	37.5	17.5	8	12	23
S6440 5-1/8	5	G1/8	5.5	14.5	10	5.5	40.5	20.5	9	12	24
S6440 6-1/8	6	G1/8	4	15	12.7	5.5	40.5	20	9	12	26
S6440 6-1/4	6	G1/4	4	15	12.7	7	42	20	9	14	31
S6440 8-1/8	8	G1/8	5	16	14.2	5.5	44	22.5	11	12	37
S6440 8-1/4	8	G1/4	5	16	14.2	7	45.5	22.5	11	14	35
S6440 8-3/8	8	G3/8	5	16.5	14.2	8	47	22.5	11	19	52
S6440 10-1/4	10	G1/4	5.8	18.5	16.5	7	51.5	26	13	14	43
S6440 10-3/8	10	G3/8	5.8	18.5	16.5	8	53	26	13	19	66
S6440 12-3/8	12	G3/8	7.3	19.5	19.5	8	54.5	26.5	15	19	65
S6440 14-1/2	14	G1/2	8.3	21.5	21.5	9	59	28.5	17	22	88

METRIC Tube Fittings

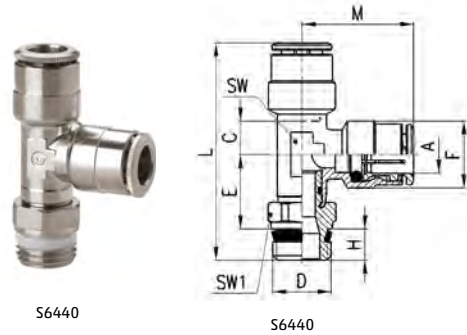

S6440

S6440

Fittings Model 6442 and Model 6440...

Male Run Tee Swivel

INCH Tube Fittings

DIMENSIONS (in inches)

Model	A	D	C	E	F	H	L	M	SW	SW1	
		OD	UNF								
6442 02-32	1/8	10-32	0.138	0.492	0.354	0.157	1.339	0.689	0.315	0.315	
6442 53-32	5/32	10-32	0.138	0.492	0.354	0.157	1.339	0.689	0.315	0.315	
		NPTF									
6440 02-02	1/8	1/8	0.138	0.650	0.354	0.315	1.535	0.689	0.315	0.472	
6440 53-02	5/32	1/8	0.138	0.650	0.354	0.315	1.535	0.689	0.315	0.472	
6440 53-04	5/32	1/4	0.138	0.689	0.354	0.472	1.634	0.689	0.315	0.551	
6440 04-02	1/4	1/8	0.157	0.669	0.500	0.315	1.654	0.787	0.354	0.472	
6440 04-04	1/4	1/4	0.157	0.709	0.500	0.472	1.752	0.787	0.354	0.551	
6440 04-06	1/4	3/8	0.157	0.689	0.500	0.472	1.772	0.787	0.354	0.748	
6440 06-04	3/8	1/4	0.236	0.846	0.650	0.472	2.146	1.024	0.512	0.551	
6440 06-06	3/8	3/8	0.236	0.827	0.650	0.472	2.165	1.024	0.512	0.748	
6440 06-08	3/8	1/2	0.256	0.906	0.650	0.610	2.283	1.043	0.512	0.866	
6440 08-04	1/2	1/4	0.315	0.906	0.768	0.472	2.205	1.043	0.591	0.669	
6440 08-06	1/2	3/8	0.280	0.866	0.768	0.472	2.205	1.043	0.591	0.748	
6440 08-08	1/2	1/2	0.315	0.945	0.768	0.610	2.323	1.043	0.591	0.866	

*add 'C' for sealant coated fittings (e.g. 6440 04-02 becomes C6440 04-02)

INCH Tube Fittings



6442

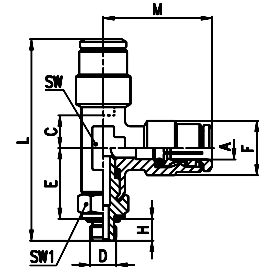

6442



6440



C6440

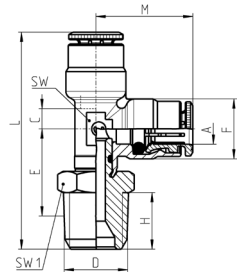

6440

METRIC Tube Fittings

DIMENSIONS (in mm)

Model	A	D	C	E	F	H	L	M	SW	SW1	Weight (g)
6442 3-M3	3	M3	-	10.7	-	2.5	21.4	13.7	6	6	5
6442 3-M5	3	M5	-	12.2	-	3.5	21.4	13.7	6	8	6
6442 4-M5	4	M5	3.5	12.5	9	4	34	17.5	8	8	18
6442 4-1/8	4	G1/8	3.5	14.5	9	6	38	17.5	8	12	19
6442 5-M5	5	M5	5.5	12.5	10	4	36.5	20.5	9	8	19
6442 6-1/8	6	G1/8	4	15	12.7	6	41	20	9	12	26
6442 6-1/4	6	G1/4	4	16	12.7	7	43	20	9	15	36
6442 8-1/8	8	G1/8	5	16	14.2	6	44.5	22.5	11	12	31
6442 8-1/4	8	G1/4	5	17	14.2	7	46.5	22.5	11	15	42
6442 8-3/8	8	G3/8	5	17	14.2	7	46.5	22.5	11	19	50
6442 10-1/4	10	G1/4	5.8	19.5	16.5	7	52.5	26	13	15	46
6442 10-3/8	10	G3/8	5.8	19.5	16.5	7	52.5	26	13	19	66
6442 12-1/4	12	G1/4	7.3	20	16.5	7	53.5	26.5	15	17	73
6442 12-3/8	12	G3/8	7.3	20.5	19.5	7	54	26.5	15	19	64

METRIC Tube Fittings



6442

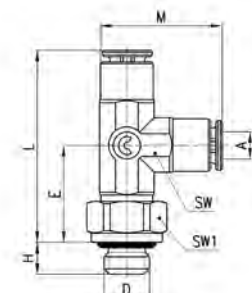

6442



6442

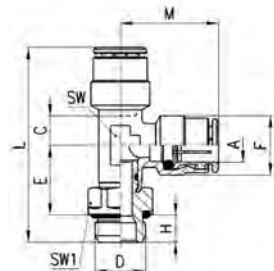

6442

Fittings Model 6463...

Female Connector

INCH Tube Fittings

DIMENSIONS (in inches)

Model	A OD	D NPTF	C	F	G	L	SW
6463 02-02	1/8	1/8	0.394	0.354	0.512	0.945	0.472
6463 02-04	1/8	1/4	0.551	0.354	0.650	1.102	0.591
6463 53-02	5/32	1/8	0.394	0.354	0.512	0.945	0.472
6463 53-04	5/32	1/4	0.551	0.354	0.650	1.102	0.591
6463 04-02	1/4	1/8	0.386	0.461	0.512	1.024	0.472
6463 04-04	1/4	1/4	0.543	0.469	0.650	1.181	0.591
6463 06-04	3/8	1/4	0.512	0.606	0.728	1.299	0.669
6463 06-06	3/8	3/8	0.551	0.606	0.787	1.339	0.669

METRIC Tube Fittings

DIMENSIONS (in mm)

Model	A	D	C	F	G	L	P (min)	SW	Weight (g)
6463 4-M5	4	M5	6.5	7.8	8.8	20.5	4.5	9	8
6463 4-1/8	4	G1/8	10	9	13	24	6	12	14
6463 5-1/8	5	G1/8	10	9.8	13	25	6	12	14
6463 6-1/8	6	G1/8	10	11.7	13	26	6	12	14
6463 6-1/4	6	G1/4	11.5	11.9	16.5	27.5	7	15	23
6463 8-1/8	8	G1/8	9.5	13.7	15.2	27	6	14	16
6463 8-1/4	8	G1/4	11.5	13.7	16.5	29	7	15	23
6463 10-1/4	10	G1/4	11.3	15.4	18.5	31.5	7	17	29



6463

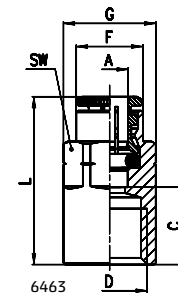

INCH Tube Fittings

METRIC Tube Fittings

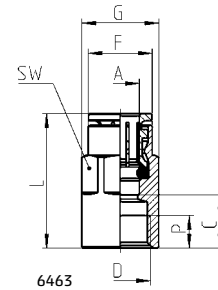

6463

Fittings Model 6593

Female Bulkhead

INCH Tube Fittings

DIMENSIONS (in inches)

Model	A OD	D NPTF	E	F	G	H	Kmax	Kmin	L	SW	SW1
6593 04-04	1/4	1/4	0.531	M12x1	0.650	0.394	0.256	0.079	1.102	0.669	0.669
6593 06-06	3/8	3/8	0.531	M18x1	0.787	0.413	0.472	0.079	1.339	0.866	0.866
6593 08-06	1/2	3/8	0.492	M20x1	0.787	0.413	0.472	0.079	1.299	0.945	0.945



6593

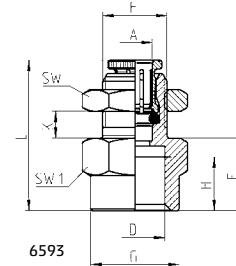

6593

METRIC Tube Fittings

DIMENSIONS (in mm)

Model	A	D	E	F	G	H	L	K (max)	K (min)	SW	SW1	Weight (g)
6593 6-1/8	6	G1/8	10	M12x1	16.4	6	24.5	8.5	2	15	17	19
6593 6-1/4	6	G1/4	11.5	M12x1	18.5	7	26	6.5	2	17	17	22
6593 8-1/8	8	G1/8	10	M15x1	18.5	6	27	9.5	2	17	19	26
6593 8-1/4	8	G1/4	11.5	M15x1	18.5	7	28.5	9.5	2	17	19	26
6593 10-3/8	10	G3/8	12.8	M18x1	24.5	8	32.5	12	2	22	22	43



6593

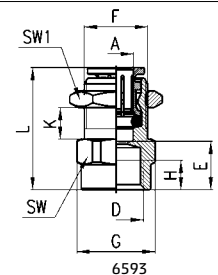

6593

Fittings Model 6523

Female Swivel Elbow

INCH Tube Fittings

DIMENSIONS (in inches)

Model	A OD	D NPTF	E	F	H	L	M	SW	SW1
6523 53-02	5/32	1/8	0.138	0.354	0.276	0.787	0.689	0.315	0.512
6523 53-04	5/32	1/4	0.138	0.354	0.394	1.004	0.689	0.315	0.669
6523 04-02	1/4	1/8	0.177	0.500	0.276	0.807	0.807	0.354	0.512
6523 04-04	1/4	1/4	0.177	0.500	0.394	0.965	0.807	0.354	0.669
6523 04-06	1/4	3/8	0.177	0.500	0.413	0.984	0.807	0.354	0.787
6523 06-04	3/8	1/4	0.236	0.650	0.394	1.102	1.024	0.512	0.669
6523 06-06	3/8	3/8	0.236	0.650	0.413	1.122	1.024	0.512	0.787



6523

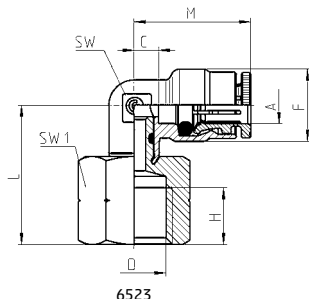

6523

INCH Tube Fittings

Fittings Model 6550...

Union Elbow

INCH Tube Fittings

DIMENSIONS (in inches)

Model	A OD	C	F	M	SW
6550 02-00	1/8	0.138	0.354	0.689	0.315
6550 53-00	5/32	0.138	0.354	0.689	0.315
6550 04-00	1/4	0.157	0.500	0.787	0.354
6550 05-00	5/16	0.197	0.559	0.886	0.433
6550 06-00	3/8	0.236	0.650	1.024	0.512
6550 08-00	1/2	0.280	0.768	1.043	0.591

METRIC Tube Fittings

DIMENSIONS (in mm)

Model	A	C	F	M	SW	Weight (g)
6550 4	4	3.5	9	17.5	8	8
6550 5	5	5.5	10	20.5	9	15
6550 6	6	4	12.7	20	9	17
6550 8	8	5	14.2	22.5	11	22
6550 10	10	5.8	16.5	26	13	30
6550 12	12	7.3	19.5	26.5	15	44
6550 14	14	8.3	21.5	28.5	17	71

INCH Tube Fittings

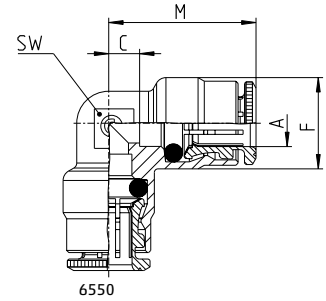

6550

6550

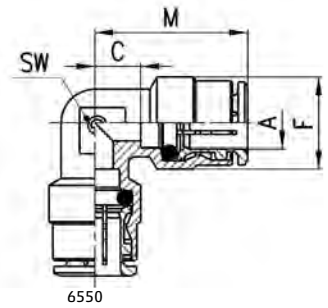

6550

6550

Fittings Model 6550

Reducing Union Elbow

INCH Tube Fittings

DIMENSIONS (in inches)

Model	A OD	B OD	C	D	F	G	M	N	SW
6550 04-53	1/4	5/32	0.177	0.157	0.500	0.394	0.807	0.709	0.354
6550 06-04	3/8	1/4	0.236	0.177	0.650	0.500	1.024	0.827	0.512
6550 08-06	1/2	3/8	0.295	0.256	0.768	0.650	1.043	1.043	0.591

INCH Tube Fittings

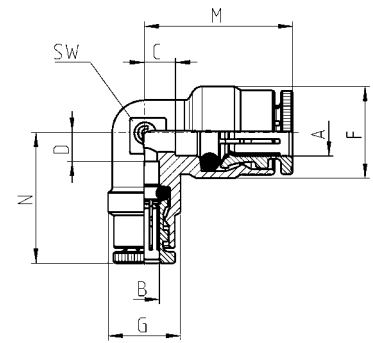

6550

6550

Fittings Model 6550 Micro

Elbow Union

METRIC Tube Fittings

DIMENSIONS (in mm)

Model	A	M	SW	Weight (g)
6550 3	3	13.7	6	3

METRIC Tube Fittings

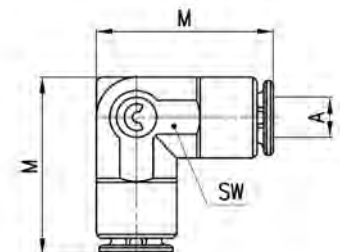

6550

6550

Fittings Model 6540...

Union Tee

INCH Tube Fittings

DIMENSIONS (in inches)

Model	A OD	C	F	L	M	SW
6540 02-00	1/8	0.138	0.354	1.378	0.689	0.315
6540 53-00	5/32	0.138	0.354	1.378	0.689	0.315
6540 04-00	1/4	0.157	0.500	1.575	0.787	0.354
6540 05-00	5/16	0.197	0.559	1.772	0.886	0.433
6540 06-00	3/8	0.236	0.650	2.087	1.024	0.512
6540 08-00	1/2	0.280	0.768	2.087	1.043	0.591

METRIC Tube Fittings

DIMENSIONS (in mm)

Model	A	C	F	L	M	SW	Weight (g)
6540 4	4	3.5	9	35	17.5	8	14
6540 5	5	5.5	10	41	20.5	9	21
6540 6	6	4	12.7	40	20	9	24
6540 8	8	5	14.2	45	22.5	11	32
6540 10	10	5.8	16.5	52	26	13	43
6540 12	12	7.3	19.5	53	26.5	15	60
6540 14	14	8.3	21.5	57	28.5	17	75



6540

INCH Tube Fittings

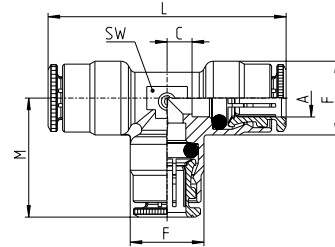

6540

METRIC Tube Fittings

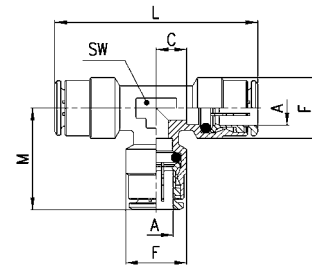

6540

Fittings Model 6540 Micro

Tee Union

METRIC Tube Fittings

DIMENSIONS (in mm)

Model	A	L	M	SW	Weight (g)
6540 3	3	21.4	13.7	6	4



6540

METRIC Tube Fittings

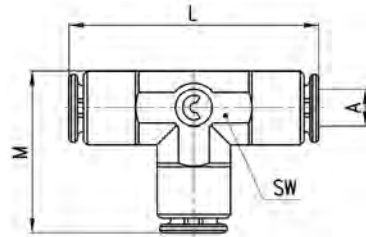

6540

Fittings Model 6540

Reducing Union Tee

INCH Tube Fittings

DIMENSIONS (in inches)

Model	A OD	B OD	C	D	F	G	L	M	SW
6540 04-04-02	1/4	1/8	0.177	0.157	0.500	0.354	1.614	0.709	0.354
6540 04-04-53	1/4	5/32	0.177	0.157	0.500	0.394	1.614	0.709	0.354
6540 06-06-04	3/8	1/4	0.236	0.197	0.650	0.500	2.047	0.827	0.512
6540 08-08-04	1/2	1/4	0.295	0.256	0.768	0.500	2.087	0.886	0.591
6540 08-08-06	1/2	3/8	0.295	0.256	0.768	0.650	2.087	1.043	0.591



6540

METRIC Tube Fittings

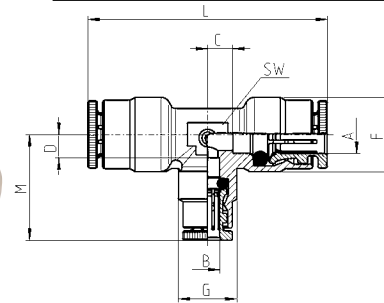

6540

Fittings Model 6560

Union "Y"

INCH Tube Fittings

DIMENSIONS (in inches)

Model	A OD	C	F	L	M
6560 02-00	1/8	0.197	0.709	1.299	0.354
6560 53-00	5/32	0.197	0.709	1.299	0.354
6560 04-00	1/4	0.256	0.965	1.535	0.492
6560 06-00	3/8	0.531	1.260	2.106	0.630

METRIC Tube Fittings

DIMENSIONS (in mm)

Model	A	C	F	L	M	Weight (g)
6560 4	4	5	18	33	9	19
6560 6	6	7	24.5	39	12.5	30
6560 8	8	9	28.5	44	14.5	42
6560 10	10	15.5	32	53.5	16	63



6560

INCH Tube Fittings

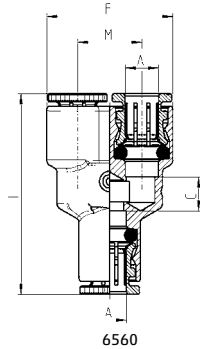

6560



6560

METRIC Tube Fittings

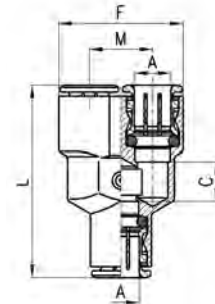

6560

Fittings Model 6560 Micro

Y Union

METRIC Tube Fittings

DIMENSIONS (in mm)

Model	A	F	L	M	SW	Weight (g)
6560 3	3	12	20.4	6	6	5



6560

METRIC Tube Fittings

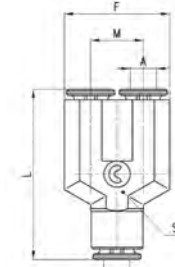

6560

Fittings Model 6600

Cross Union

METRIC Tube Fittings

DIMENSIONS (in mm)

Model	A	F	L	M	SW	Weight (g)
6600 4	4	9	38	19	9	26
6600 5	5	10	41	20.5	9	29
6600 6	6	12.7	44	22	10	35
6600 8	8	14.2	49	24.5	12	50
6600 10	10	16.5	55	27.5	14	63
6600 12	12	19.5	56	28	16	84



6600

METRIC Tube Fittings



6600

Fittings Model 6580...

Union

INCH Tube Fittings

DIMENSIONS (in inches)

Model	A OD	F	G	L	N
6580 02-00	1/8	0.331	0.354	1.142	0.551
6580 53-00	5/32	0.331	0.354	1.142	0.551
6580 04-00	1/4	0.461	0.472	1.319	0.638
6580 05-00	5/16	0.539	0.551	1.457	0.689
6580 06-00	3/8	0.606	0.669	1.614	0.787
6580 08-00	1/2	0.720	0.748	1.555	0.756

METRIC Tube Fittings

DIMENSIONS (in mm)

Model	A	F	G	L	N	S	S1	S2	Weight (g)
6580 3	3	5.8		19.9	-	2.2	-	-	2
6580 4	4	8.4	9	29	14	5	2.2	1.6	11
6580 5	5	9.4	10	31	15	5	2.2	1.6	15
6580 6	6	11.7	12	34	16	5	2.2	1.6	16
6580 8	8	13.7	14	37	17.5	5	2.2	1.6	23
6580 10	10	15.4	17	41.5	20.2	5	2.2	1.6	33
6580 12	12	18.3	19	39.5	19.2	5.2	2.2	1.6	40
6580 14	14	20.5	21	41.5	20.2	5.2	2.2	1.6	47
6580 16	16	-	47	47	23	-	-	-	60

INCH Tube Fittings



6580

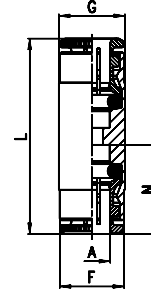

6580

METRIC Tube Fittings



6580

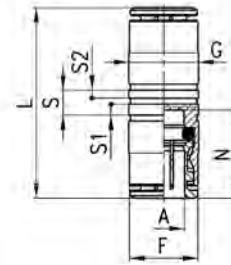

6580

Fittings Model 6580

Reducing Union

INCH Tube Fittings

DIMENSIONS (in inches)

Model	A OD	B OD	F	G	L	M	N
6580 04-02	1/4	1/8	0.472	0.362	1.240	0.630	0.551
6580 04-53	1/4	5/32	0.472	0.362	1.240	0.630	0.551
6580 06-04	3/8	1/4	0.630	0.472	1.496	0.787	0.630

METRIC Tube Fittings

DIMENSIONS (in mm)

Model	A	B	F	G	L	M	N	Weight (g)
6580 6-4	6	4	12	9	31.5	16	14	12
6580 8-6	8	6	14	12.2	35	17.5	16	19
6580 10-8	10	8	16	14	39	20	17.5	25
6580 12-10	12	10	19	16	40.5	19	20	35

INCH Tube Fittings



6580

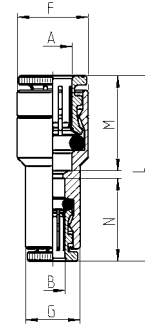

6580

METRIC Tube Fittings



6580

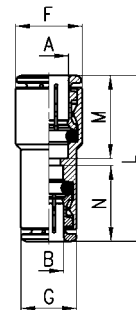

6580

Fittings Model 6590...

Bulkhead Union

INCH Tube Fittings

DIMENSIONS (in inches)

Model	A OD	B	F	L	N	MAX	SW	SW1	T
6590 02-00	1/8	M10X1	0.346	1.142	0.551	0.453	0.551	0.551	0.866
6590 53-00	5/32	M10X1	0.346	1.142	0.551	0.413	0.551	0.551	0.866
6590 04-00	1/4	M14X1	0.492	1.319	0.638	0.453	0.669	0.669	0.925
6590 05-00	5/16	M16X1	0.571	1.417	0.689	0.453	0.748	0.748	0.925
6590 06-00	3/8	M18X1	0.622	1.614	0.787	0.512	0.866	0.866	1.024
6590 08-00	1/2	M20X1	0.740	1.555	0.756	0.571	0.945	0.945	1.083

METRIC Tube Fittings

DIMENSIONS (in mm)

Model	A	B	F	L	N	MAX	SW	SW1	T	Weight (g)
6590 4	4	M10x1	8.8	29	14	10.5	14	14	20	16
6590 5	5	M12x1	9.8	31	15	10.5	17	17	20	25
6590 6	6	M14x1	12.5	33	16	10.5	17	17	20	28
6590 8	8	M16x1	14.5	36	17.5	11.5	19	19	21	35
6590 10	10	M18x1	16.3	41.5	20.2	13	22	22	23.5	51
6590 12	12	M20x1	18.8	39.5	19.2	14.5	24	24	25	56
6590 14	14	M22x1	20.5	41.5	20.2	17.5	27	27	30	82

Fittings Model 6590 Micro

Bulkhead Union

METRIC Tube Fittings

DIMENSIONS (in mm)

Model	A	B	F	L	MAX	T	Weight (g)
6590 3	3	M7x0.75	5.8	18.4	5	11.4	4

INCH Tube Fittings



6590

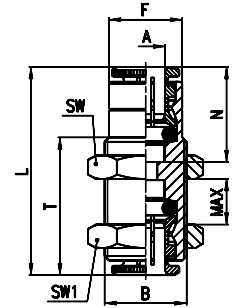

6590

METRIC Tube Fittings



6590

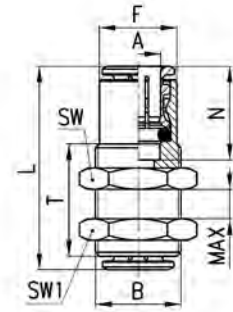

6590

METRIC Tube Fittings



6590

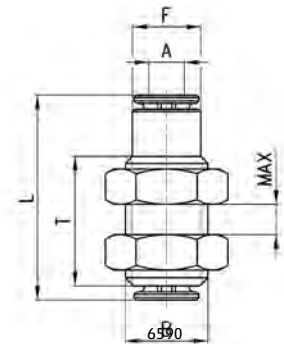

Fittings Model 6800

Plug-in Reducer

INCH Tube Fittings

DIMENSIONS (in inches)

Model	A OD	G STEM OD	C	F	L	T
6800 02-53	1/8	5/32	0.689	0.354	1.240	0.650
6800 02-04	1/8	1/4	0.610	0.354	1.161	0.709
6800 53-04	5/32	1/4	0.610	0.354	1.161	0.709
6800 53-06	5/32	3/8	0.689	0.379	1.220	0.906
6800 04-05	1/4	5/16	0.728	0.500	1.358	0.807
6800 04-06	1/4	3/8	0.827	0.500	1.457	0.906
6800 04-08	1/4	1/2	0.689	0.504	1.319	0.945
6800 05-06	5/16	3/8	0.787	0.551	1.496	0.906
6800 05-08	5/16	1/2	0.846	0.551	1.535	0.945
6800 06-08	3/8	1/2	0.787	0.650	1.575	0.945

METRIC Tube Fittings

DIMENSIONS (in mm)

Model	A	G	C	F	L	T	Weight (g)
6800 4-5	4	5	19	9	33	18	8
6800 4-6	4	6	15.5	9	29.5	18	9
6800 4-8	4	8	18	9	32	20.5	10
6800 5-6	5	6	19	10	34	18	11
6800 5-8	5	8	18	10	33	20.5	12
6800 6-8	6	8	18	12.7	34	20.5	12
6800 6-10	6	10	20.5	12.7	36.5	23	17
6800 6-12	6	12	17.5	12.7	33.5	24	21
6800 8-10	8	10	20.5	14	38	23	15
6800 8-12	8	12	21.5	14	39	24	22
6800 10-12	10	12	20.3	16.5	40.5	24	27
6800 10-14	10	14	24.3	16.5	44.5	28	33
6800 12-14	12	14	24.3	18.8	45.5	28	27

METRIC Tube Fittings

DIMENSIONS (in mm)

Model	A	F	G	L	T	Weight (g)
6800 3-4	3	5.8	4	26	16.5	2

INCH Tube Fittings



6800

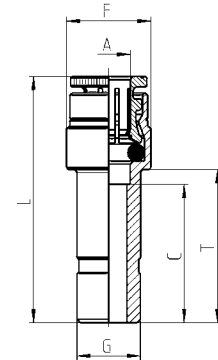

6800

METRIC Tube Fittings



6800

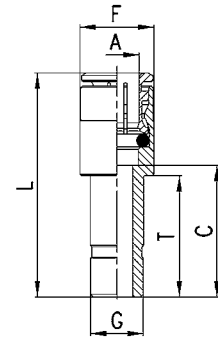

6800



6800

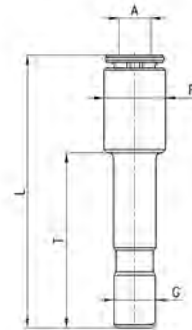

6800

Fittings Model 6555...

Plug-In Elbow

INCH Tube Fittings

DIMENSIONS (in inches)

Model	A OD	G STEM OD	C	L	F	T	M	SW
6555 53-53	5/32	5/32	0.138	0.866	0.354	0.650	0.689	0.315
6555 04-04	1/4	1/4	0.157	0.965	0.500	0.709	0.787	0.354
6555 06-06	3/8	3/8	0.236	1.260	0.650	0.906	1.024	0.512

METRIC Tube Fittings

DIMENSIONS (in mm)

Model	A	G	C	L	F	T	M	SW	Weight (g)
6555 4-4	4	4	3.5	22	9	16.5	17.5	9	8
6555 6-6	6	6	4	24.5	12.7	18	20	9	14
6555 8-8	8	8	5	27.5	14.2	20	22.5	11	21
6555 10-10	10	10	5.8	32	16.5	23	26	13	26

INCH Tube Fittings

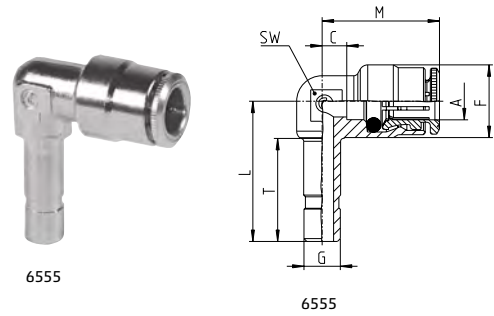

6555

6555

METRIC Tube Fittings

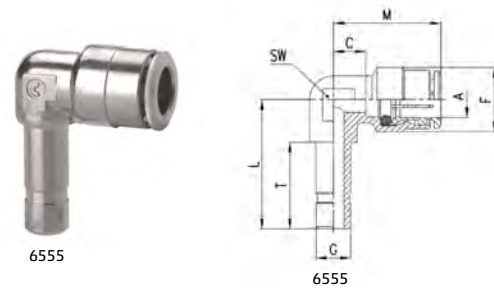

6555

6555

Fittings Model 6850

Plug-in Expander

INCH Tube Fittings

DIMENSIONS (in inches)

Model	A OD	G STEM OD	C	F	L	T
6850 04-53	1/4	5/32	0.709	0.500	1.299	0.650
6850 04-02	1/4	1/8	0.709	0.500	1.299	0.650
6850 06-04	3/8	1/4	0.748	0.650	1.535	0.709

METRIC Tube Fittings

DIMENSIONS (in mm)

Model	A	G	C	F	L	T	Weight (g)
6850 6-4	6	4	17.5	12.7	33.5	16.5	11
6850 8-6	8	6	19	14	36.5	18	15

INCH Tube Fittings

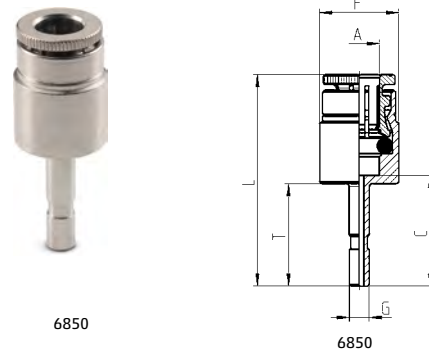

6850

6850

METRIC Tube Fittings

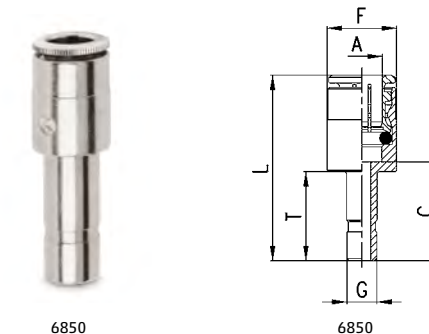

6850

6850

Fittings Model 6950...

Double Stem Union

INCH Tube Fittings

DIMENSIONS (in inches)

Model	G STEM OD	L
6950 02-00	1/8	1.279
6950 53-00	5/32	1.279
6950 04-00	1/4	1.397
6950 05-00	5/16	1.594
6950 06-00	3/8	1.811
6950 08-00	1/2	1.889

METRIC Tube Fittings

DIMENSIONS (in mm)

Model	G	L	Weight (g)
6950 4	4	32.5	3
6950 6	6	35.5	4
6950 8	8	40.5	7
6950 10	10	46	10
6950 12	12	48	13
6950 14	14	52	17

INCH Tube Fittings



6950

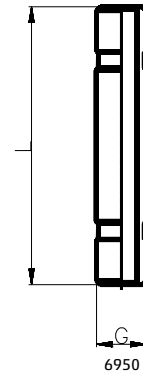

6950

METRIC Tube Fittings



6950

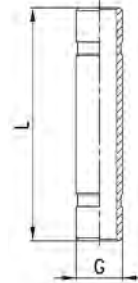

6950

Fittings Models 6810 and 6811...

Male Plug-in Stem

INCH Tube Fittings

DIMENSIONS (in inches)

Model	G STEM OD	D NPTF	H	T	L	SW
6810 02-02	1/8	1/8	.315	.649	1.141	.472
6810 02-04	1/8	1/4	.472	.649	1.319	.551
6810 53-02	5/32	1/8	.315	.649	1.141	.472
6810 53-04	5/32	1/4	.472	.649	1.319	.551
6810 04-02	1/4	1/8	.315	.708	1.200	.472
6810 04-04	1/4	1/4	.472	.708	1.378	.551
6810 05-02	5/16	1/8	.315	.807	1.299	.472
6810 05-04	5/16	1/4	.472	.807	1.476	.551
6810 06-04	3/8	1/4	.472	.905	1.575	.551
6810 06-06	3/8	3/8	.472	.905	1.575	.748
6810 08-06	1/2	3/8	.472	.944	1.614	.748
6810 08-08	1/2	3/8	.610	.944	1.772	.866

METRIC Tube Fittings

DIMENSIONS (in mm)

Model	G	D	H	T	L	SW	Weight (g)
6811 4-M5	4	M5	4	16.5	24.5	8	3 *
6811 4-1/8	4	G1/8	5.5	16.5	27.8	12	10
6811 5-1/8	5	G1/8	5.5	18	29.3	12	9
6811 5-1/4	5	G1/4	7	18	31	14	11
6811 6-1/8	6	G1/8	5.5	18	29.3	12	10
6811 6-1/4	6	G1/4	7	18	31	14	12
6811 8-1/8	8	G1/8	5.5	20.5	31.8	12	12
6811 8-1/4	8	G1/4	7	20.5	33.5	14	13
6811 10-1/4	10	G1/4	7	23	36	14	16
6811 10-3/8	10	G3/8	8	23	37.3	19	25
6811 12-3/8	12	G3/8	8	24	38.3	19	25
6811 14-1/2	14	G1/2	9	28	44	22	39



6810

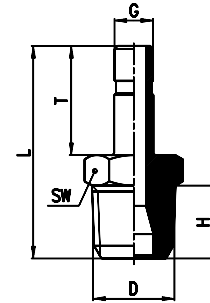

6810

INCH Tube Fittings



6811

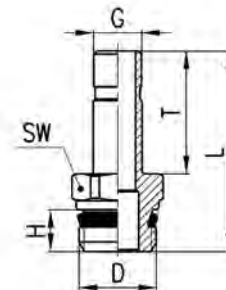

6811

* = with O-Ring

Fittings Model 6700...

Cartridge

The Dimension 'H2' for the press-tool should be noted and followed, which creates a specific mechanical stop. This serves the purpose of avoiding, (in case of any excessive insertion force used), damage to the collet body, shape or design. Without which, could lead to some damage or distortion of the collet bite/release ring.

Surface Finish of the gland seat required : Ra <= 0.8 microns.

Final Fit and Finish requires that the top most ridge/bite-ring of the cartridge body be at least 1 mm below the surface of the gland chamfer.

- * Hole tolerances: +0, -0.002 (in.)
- * For plastic (non-metal) manifolds, reduce all hole dimensions "S" by 0.02 mm (0.001 in.)
- * INSTALLATION: Drill or bore hole per specifications per size of cartridge (dimensions H and S).
- * Smooth or ream hole dimensions to hole tolerances.
- * Simply press fit cartridge into hole with an evenly distributed force over the top surface.
- * Removal of the collet ring is not necessary.
- * Cartridge fittings are useful for installations in various manifolds and/or distribution blocks when drilling and tapping are not desirable.

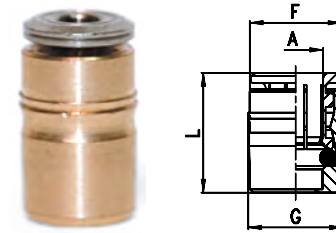

Insertion Force - KG

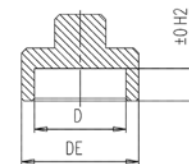
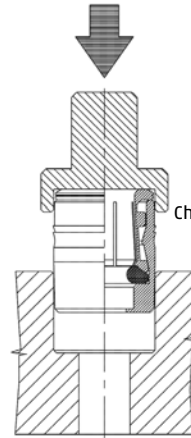

0.5 x 45° Chamfer Required

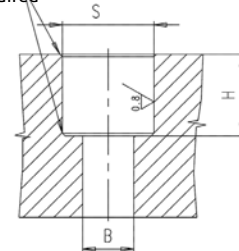

Gland Width "S" Tolerances
+ .0" / - .002" Metal Seat Tolerance

PUSH-IN FITTINGS

INCH Tube Fittings												
DIMENSIONS (in inches)												
Model	A OD	F	G	L	S	H	B	Insertion Force		D	H2	DE
								Kg. Min	Kg. Max			
6700 02-00	1/8	0.339	0.346	0.571	0.344	0.453	0.138	200	360	0.347	0.129	0.551
6700 53-00	5/32	0.339	0.346	0.571	0.344	0.433	0.138	200	360	0.347	0.129	0.551
6700 04-00	1/4	0.465	0.472	0.669	0.470	0.472	0.158	160	570	0.472	0.149	0.669
6700 05-00	5/16	0.543	0.551	0.709	0.549	0.551	0.236	140	400	0.551	0.129	0.748
6700 06-00	3/8	0.622	0.630	0.807	0.628	0.649	0.315	150	650	0.630	0.138	0.827
6700 08-00	1/2	0.740	0.748	0.776	0.746	0.610	0.413	150	650	0.748	0.138	0.945



METRIC Tube Fittings													
DIMENSIONS (in mm)													
Model	A	B	D	DE	F	G	H	H2	L	S*	P min (Kg)	P max (Kg)	Weight (g)
6700 4	4	3.5	8.8	14	8.6	9	11	3.3	14.5	8.75	200	360	4
6700 5	5	3.5	9.8	15	9.6	10	11.5	3.3	15.5	9.75	200	360	5
6700 6	6	4	12	17	11.8	12.2	12	3.8	16.5	11.95	160	570	8
6700 8	8	6	14	19	13.8	14.2	14	3.3	18	13.95	140	400	11
6700 10	10	8	16	21	15.8	16.2	16.5	3.5	20.5	15.95	150	650	15

*For the Ø3 Cartridge, Chamfer 0.3 x 30°

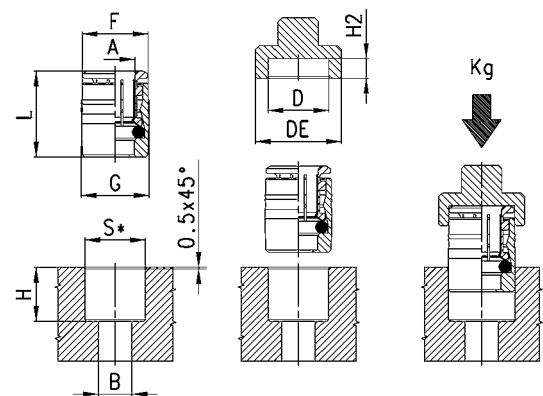

*S = metallic (+0.01, -0.04)

Fittings Model 6750

Tube Cap

INCH Tube Fittings**DIMENSIONS (in inches)**

Model	A OD	G	L
6750 53-00	5/32	0.346	0.610
6750 04-00	1/4	0.472	0.669
6750 06-00	3/8	0.602	0.827
6750 08-00	1/2	0.717	0.787

METRIC Tube Fittings**DIMENSIONS (in mm)**

Model	A	G	L	Weight (g)
6750 4	4	8.8	15	4
6750 6	6	11.8	17	7
6750 8	8	13.8	18.5	9
6750 10	10	15.8	21	12
6750 12	12	17.8	20	15

INCH Tube Fittings

6750

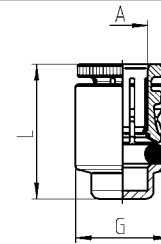

6750

METRIC Tube Fittings

6750

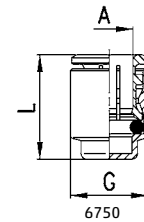

6750

Fitting Protection Cap Model 6708

Color: Black

Self-extinguishing material, class V0

METRIC Tube Fittings**DIMENSIONS (in mm)**

Model	A	F	L	Weight (g)
6708 4	4	10.7	10.7	1
6708 5	5	11.7	11	1
6708 6	6	13.7	11.5	1
6708 8	8	15.7	12.5	1
6708 10	10	18.5	13	1
6708 12	12	20.7	15	2
6708 14	14	23.7	15	2



6708

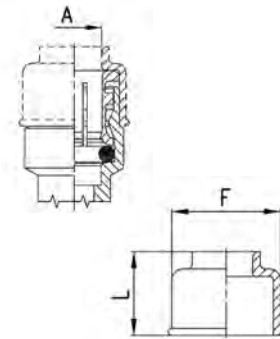

6708

Fittings Model 6900...

Plug (Nylon®)

INCH Tube Fittings**DIMENSIONS (in inches)**

Model	G STEM OD	L	P	T
6900 02-00	1/8	1.063	.236	.787
6900 53-00	5/32	1.141	.315	.787
6900 04-00	1/4	1.240	.315	.885
6900 05-00	5/16	1.358	.472	.964
6900 06-00	3/8	1.456	.472	1.063
6900 08-00	1/2	1.594	.630	1.122

METRIC Tube Fittings**DIMENSIONS (in mm)**

Model	G	L	P	T	Weight (g)
6900 3	3	20.5	6	13.5	1
6900 4	4	29	8	20	1
6900 5	5	29.5	8	20.5	1
6900 6	6	31.5	8	22.5	1
6900 8	8	34.5	12	24.5	2
6900 10	10	37	12	27	2
6900 12	12	40.5	16	28.5	3
6900 14	14	42.5	16	30.5	3

INCH Tube Fittings

6900

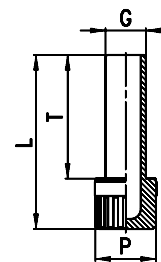

6900

METRIC Tube Fittings

6900

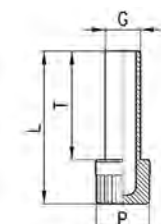

6900

Fittings Model 1631-01...

Stud Manifold

INCH Tube Fittings

DIMENSIONS (in inches)

Model	A	H	L	S	SW
UNF					
1631 01-32	10-32	.157	.708	.177	.315
NPTF*					
1631 01-02	1/8	.236	1.063	.335	.551
1631 01-04	1/4	.354	1.161	.335	.669
1631 01-06	3/8	.354	1.181	.335	.748

METRIC Tube Fittings

DIMENSIONS (in mm)

Model	A	H	L	S	SW	Weight (g)
1631 01-M5	M5	4	18	5.5	8	3
1631 01-1/8	G1/8	6	27	8.5	14	13
1631 01-1/4	G1/4	8	29.5	8.5	17	24
1631 01-3/8	G3/8	8	30	8.5	19	35
1631 01-1/2	G1/2	9	31	8.5	27	63

NPTF Threads

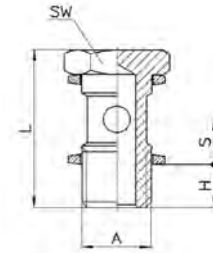

*NPTF 2520 Adapters included

BSP Threads

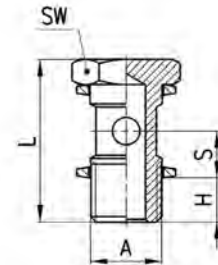

Single Banjo Stem

Assembled with banjo fittings Model 6610; 6620; 1610; 1620; 2023; 1170

Fittings Model 1635 02

Single Long Banjo Stem

Assembled with banjo fittings Model 6610; 6620; 1610; 1620; 2023; 1170

METRIC Tube Fittings

DIMENSIONS (in mm)

Model	A	H	L	S	SW	Weight (g)
1635 01-1/8	G1/8	6	31	12.5	14	15
1635 01-1/4	G1/4	8	33.5	12.5	17	27
1635 01-3/8	G3/8	8	34	12.5	19	37
1635 01-1/2	G1/2	9	35	12.5	27	71
1635 01-M12x1.25	M12x1.25	8	33.5	12.5	17	27 *
1635 01-M12x1.5	M12x1.5	8	33.5	12.5	17	27 *

BSP Threads

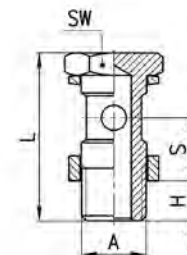

* = models that must be assembled with 1/4 banjo fittings

Fittings Model 1631-02...

Double Stud Manifold

Assembled with banjo fittings Model 6610; 6620; 1610; 1620; 2023; 1170

NPTF THREADS

DIMENSIONS (in inches)

Model	A	H	L	SW
	NPTF*			
1631 02-02	1/8	.236	1.692	.551
1631 02-04	1/4	.315	1.791	.669
1631 02-06	3/8	.354	1.811	.748

BSP THREADS

DIMENSIONS (in mm)

Model	A	H	L	SW	Weight (g)
1631 02-1/8	G1/8	6	43	14	18
1631 02-1/4	G1/4	8	45.5	17	33
1631 02-3/8	G3/8	8	46	19	48

NPTF Threads



*NPTF 2520 Adapter included

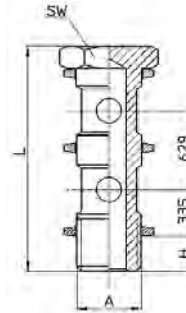

BSP Threads

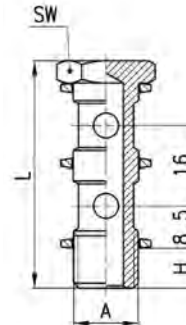

Fittings Model 1635 02

Double Long Banjo Stem

Assembled with banjo fittings Model 6610; 6620; 1610; 1620; 2023; 1170

BSP THREADS

DIMENSIONS (in mm)

Model	A	H	L	SW	Weight (g)
1635 02-1/8	G1/8	6	56	14	26
1635 02-1/4	G1/4	8	58.5	17	33
1635 02-3/8	G3/8	8	59	19	64
1635 02-1/2	G1/2	9	60	27	111

BSP Threads

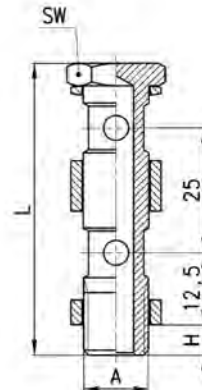

Fittings Model 1631-03...

Triple Stud Manifolds

NPTF THREADS

DIMENSIONS (in inches)

Model	A	H	L	SW
NPTF*				
1631 03-02	1/8	.236	2.322	.551
1631 03-04	1/4	.315	2.421	.669
1631 03-06	3/8	.354	2.440	.748

BSP THREADS

DIMENSIONS (in mm)

Model	A	H	L	SW	Weight (g)
1631 03-1/8	G1/8	6	59	14	24
1631 03-1/4	G1/4	8	61.5	17	42
1631 03-3/8	G3/8	8	62	19	62

Assembled with banjo fittings Model 6610; 6620; 1610; 1620; 2023; 1170



NPTF Threads

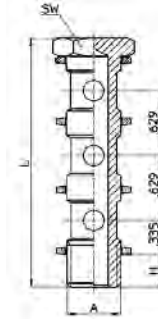

*NPTF 2520 Adapters included

BSP Threads

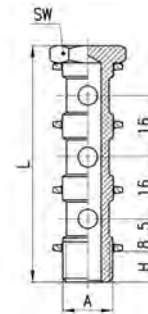

Fittings Model 6610 assembled with Model 1631, 1635

Single Banjo

INCH Tube Fittings

DIMENSIONS (in inches)

Model	A OD	V	C	F	M	O	V	W
6610 53-32	5/32	10-32	0.197	0.346	0.748	0.354	0.197	0.346
6610 02-02	1/8	1/8	0.295	0.354	0.846	0.571	0.382	0.551
6610 53-02	5/32	1/8	0.335	0.394	0.886	0.571	0.382	0.551
6610 04-02	1/4	1/8	0.327	0.500	0.965	0.571	0.382	0.551
6610 04-04	1/4	1/4	0.406	0.500	1.043	0.571	0.516	0.709
6610 06-04	3/8	1/4	0.354	0.650	1.142	0.571	0.516	0.709
6610 06-06	3/8	3/8	0.413	0.650	1.201	0.571	0.657	0.827

METRIC Tube Fittings

DIMENSIONS (in mm)

Model	A	C	F	M	O	V	W	Weight (g)
6610 4-M5	4	5	9	19	9	5.1	∅9	9
6610 4-M6	4	5	9	19	9	5.1	∅9	8
6610 4-1/8	4	7.5	9	21.5	14.5	9.8	∅14	14
6610 5-M5	5	5	10	20	9	5.1	∅9	9
6610 5-M6	5	5	10	20	9	5.1	∅9	8
6610 5-1/8	v	8	10	23	14.5	9.8	∅14	16
6610 6-M5	6	6.5	12.7	22.5	9	5.1	∅10	12
6610 6-M6	6	6.5	12.7	22.5	9	5.1	∅10	12
6610 6-1/8	6	8	12.7	24	14.5	9.8	∅14	16
6610 6-1/4	6	10	12.7	26	14.5	13.2	∅18	19
6610 8-1/8	8	8	14.2	25.5	14.5	9.8	∅14	19
6610 8-1/4	8	10	14.2	27.5	14.5	13.2	∅18	22
6610 8-3/8	8	11	14.2	28.5	14.5	16.7	∅21	23
6610 10-1/4	10	8.8	16.5	29	14.5	13.2	∅18	22 *
6610 10-3/8	10	10.3	16.5	30.5	14.5	16.7	∅21	23 *
6610 12-1/2	12	12.8	16.5	32	14.5	21	∅26	37 *

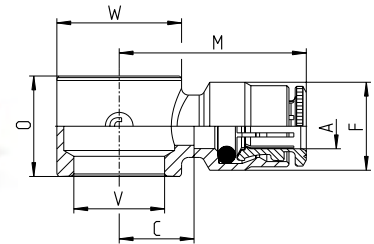

INCH Tube Fittings

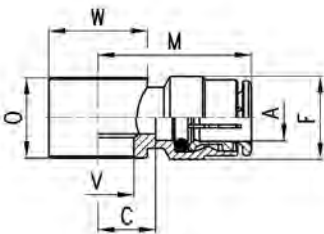

METRIC Tube Fittings

= assembly required with Model SCU, SVU, SCO... M5 only
 * = they cannot be assembled with Model 1631, use 1635 instead

Fittings Model 6620...

Double Banjo

INCH Tube Fittings

DIMENSIONS (in inches)

Model	A OD	V	C	F	L	O	V	W
6620 53-32	5/32	10-32	0.197	0.346	1.496	0.354	0.197	0.346
6620 04-02	1/4	1/8	0.327	0.461	1.929	0.571	0.382	0.551
6620 04-04	1/4	1/4	0.406	0.461	2.087	0.571	0.516	0.709

METRIC Tube Fittings

DIMENSIONS (in mm)

Model	A	C	F	L	O	V	W	Weight (g)
6620 4-M5	4	5	9	38	9	5.1	Ø 9	13
6620 4-1/8	4	7.5	9	43	14.5	9.8	Ø 14	19
6620 6-1/8	6	8	12.7	48	14.5	9.8	Ø 14	24
6620 6-1/4	6	10	12.7	52	14.5	13.2	Ø 18	26
6620 8-1/8	8	8	14.2	51	14.5	9.8	Ø 14	32
6620 8-1/4	8	10	14.2	55	14.5	13.2	Ø 18	34



INCH Tube Fittings

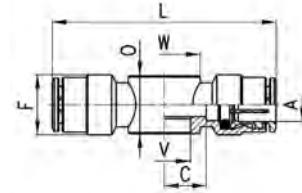

METRIC Tube Fittings

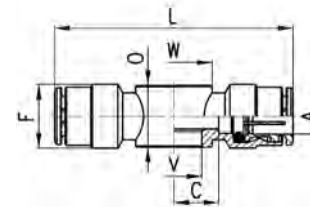

Fittings Model 2023 assembled with Model 1631, 1635

Female Banjo

NPTF THREADS

DIMENSIONS (in inches)

Model	B	V	O	M	W
UNF					
2023 32-32	10-32	10-32	.354	.413	.346
NPTF					
2023 02-02	1/8	1/8	.571	.787	.551
2023 04-04	1/4	1/4	.571	1.004	.709
2023 06-06	3/8	3/8	.571	1.102	.827

BSP THREADS

DIMENSIONS (in mm)

Model	B	M	O	V	W	Weight (g)
2023 M5-M5	M5	10.5	9	5.1	9	6
2023 M5-M6	M5	10.5	9	5.1	9	6
2023 1/8-1/8	G1/8	20	14.5	9.8	Ø 14	14
2023 1/4-1/4	G1/4	23.5	14.5	13.2	Ø 18	21
2023 3/8-3/8	G3/8	26.5	14.5	16.7	Ø 21	27



INCH Tube Fittings

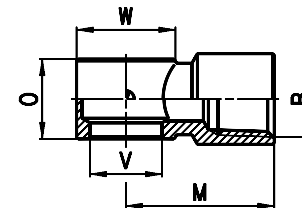

METRIC Tube Fittings

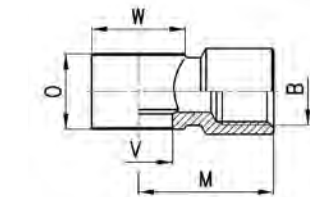

= assembly with Model SCU, SCO, SVU... M5
= assembly with Model 1635

Example assembly of stud manifold with various banjos



1631

+



6610

+



6620

+



2023

+



2520

=



Model
1631 01-
1631 02-
1631 03-

Accessories Model 2651

Aluminium Washer

DIMENSIONS (in inches)				
Model	A	B	H	Weight (g)
2651 1/8	14	9.8	1.5	1
2651 1/4	18	13.2	1.5	1
2651 3/8	22	16.7	1.5	1
2651 1/2	26	20.9	1.5	1
2651 1	38.5	33.4	1.5	2

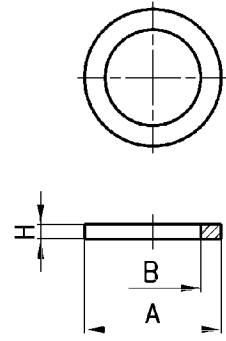

Accessories Model 2661

Nylon Washer

DIMENSIONS (in inches)				
Model	A	B	H	Weight (g)
2661 M3	4.9	2.8	0.7	1
2661 M5	8	5.2	1	1
2661 M6	9	6.2	1	1
2661 1/8	14	10.2	1.9	1
2661 1/4	18	13.5	1.9	1
2661 3/8	21	16.5	2.1	1
2661 1/2	26	21.2	1.9	1

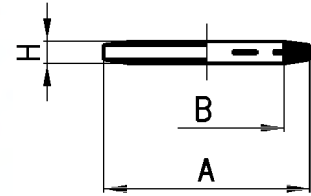

Accessories Model 2665

Nylon Washer

DIMENSIONS (in inches)				
Model	A	B	H	Weight (g)
2665 1/8	14	9.8	5	1
2665 1/4	18	13.2	5	1
2665 3/8	21	16.8	5	1
2665 1/2	26	21.1	5	1

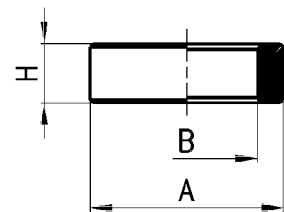

Accessories Model 2669

Nylon Washer

DIMENSIONS (in inches)				
Model	A	B	H	Weight (g)
2669 1/8	14	9.8	10	1
2669 1/4	18	13.2	10	2
2669 3/8	21	16.8	10	2
2669 1/2	26	21.1	10	2

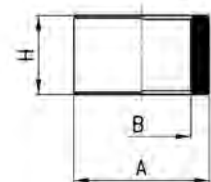

Accessory Model SP

Disconnecting tube set



The set includes keys to disconnect tubes with diameters between 4 and 12 mm. or 5/32" OD to 1/2" OD

Model	
SP	

Model 6RT - Metallic Tubing Scribing Tool

For high pressure applications with stainless steel or metallic tubing up to 1200 psi, so long as the tubing is cut and scored according to the procedures and tool geometry provided by Camozzi Pneumatics, Inc. To be used with Camozzi 6000 Series brass fittings and collets ONLY.

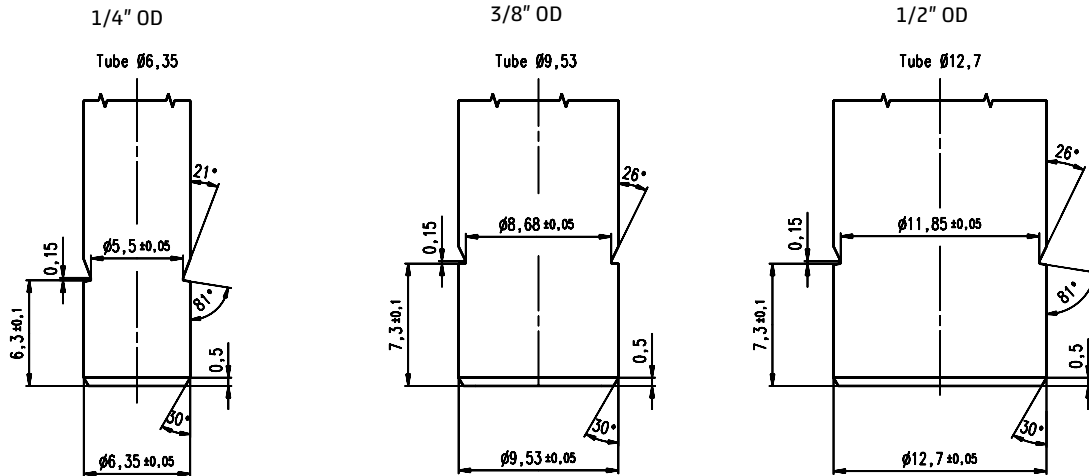

Final groove dimensions above are for checking depth and length of final groove made on metallic tubes.

Model	Tubing Sizes Served	Spare Roller Cutting Wheel
6RT 04	1/4" - 6mm - 8mm OD	RRT 6-8
6RT 06-08	3/8" - 1/2" - 10mm - 12mm OD	RRT 9.53-12.7

Nickel-Plated Brass DOT Fittings NPTF/Inch Series ND

Tube Diameter OD : 5/32", 1/4", 3/8", 1/2", 5/8", 3/4"

Thread Type : 1/8", 1/4", 3/8", 1/2", 3/4" NPTF



The US Department prohibits the use of air brake tubing assemblies between the frame and axle or between a towed and towing vehicle.

- Meets all requirements for Federal DOT Standard 571.106* 49 CFR Ch. V
- Meets all requirements for SAE J2494-3
- Temperature Range: -58°F to 200°F
- Electrolytic Nickel Plated brass body with a low temperature BUNA-N O-ring
- For use with SAE J844 A & B Nylon tubing
- Compressed air applications
- Thread pre-coated with sealant

GENERAL DATA

Material	Electrolytic Nickel-plated brass OT58 UNI 5705, Tube-support/insert in glass-reinforced Nylon
Collet	Brass OT58, nickel plated
O-ring	Low temperature Buna-N (NBR)
Threads	10/32 UNF, 1/8", 1/4", 3/8", 1/2", 3/4" NPTF
Temperature Range	-58°F - 200°F
Operating pressure	0 - 275 psi (3/4" tube size operating pressure = 0 - 175 psi)
Fluid	Compressed air [for other types of fluid please contact your local Camozzi branch]
Tube diameter	5/32", 1/4", 3/8", 1/2", 5/8", 3/4" OD

Fittings Model ND6510

Male Connector

DIMENSIONS (in inches)

Mod.	A OD	D NPTF	C	F	G	H	L	SW	SW1
ND6512 04-32	1/4	10/32UNF	0.520	0.307	0.346	0.157	0.787	0.315	0.079
ND6512 53-32	5/32	10/32UNF	0.606	0.461	0.520	0.157	0.866	0.472	0.079
ND6510 53-02	5/32	1/8	0.520	0.346	0.548	0.315	0.748	0.472	0.098
ND6510 53-04	5/32	1/4	0.520	0.346	0.639	0.472	0.906	0.551	0.098
ND6510 04-02	1/4	1/8	0.606	0.461	0.548	0.315	0.925	0.472	0.157
ND6510 04-04	1/4	1/4	0.606	0.461	0.639	0.472	1.043	0.551	0.157
ND6510 04-06	1/4	3/8	0.606	0.461	0.868	0.472	1.063	0.748	0.157
ND6510 04-08*	1/4	1/2	0.606	0.461	1.004	0.610	0.906	0.866	0.157
ND6510 06-02	3/8	1/8	0.787	0.606	0.776	0.315	1.201	0.669	0.197
ND6510 06-04	3/8	1/4	0.787	0.606	0.776	0.472	1.358	0.669	0.276
ND6510 06-06	3/8	3/8	0.787	0.606	0.868	0.472	1.161	0.748	0.276
ND6510 06-08	3/8	1/2	0.787	0.606	1.005	0.610	1.181	0.866	0.276
ND6510 08-04	1/2	1/4	0.787	0.736	0.868	0.472	1.358	0.748	0.276
ND6510 08-06	1/2	3/8	0.787	0.736	0.868	0.472	1.319	0.748	0.394
ND6510 08-08	1/2	1/2	0.787	0.736	1.005	0.610	1.280	0.866	0.394
ND6510 08-12	1/2	3/4	0.787	0.736	1.233	0.610	1.240	1.063	0.394
ND6510 10-06	5/8	3/8	0.976	0.925	1.096	0.472	1.575	0.945	0.394
ND6510 10-08	5/8	1/2	0.976	0.925	1.096	0.610	1.693	0.945	0.512
ND6510 12-06*	3/4	3/8	27.8	1.055	1.232	0.472	1.594	1.063	0.394
ND6510 12-08	3/4	1/2	1.094	1.055	1.233	0.610	1.732	1.063	0.512
ND6510 12-12	3/4	3/4	1.094	1.055	1.233	0.610	1.417	1.063	0.512

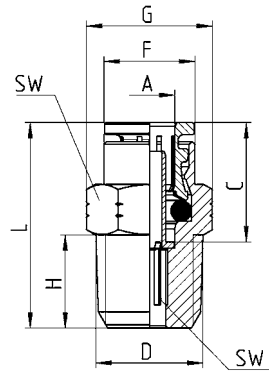

ND6510

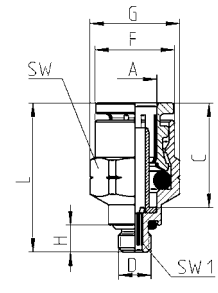

ND6512

*Produced Upon Request
Contact Camozzi USA for Availability

Fittings Model ND6520

Male Swivel Elbow

DIMENSIONS (in inches)

Mod.	A OD	D NPTF	C	F	E	H	M	SW	SW1
ND6522 04-32	1/4	10/32UNF	0.606	0.500	0.531	0.157	0.807	0.354	0.394
ND6520 53-02	5/32	1/8	0.520	0.354	0.650	0.315	0.689	0.315	0.472
ND6520 53-04	5/32	1/4	0.520	0.354	0.689	0.472	0.689	0.315	0.551
ND6520 04-02	1/4	1/8	0.606	0.500	0.669	0.315	0.807	0.354	0.472
ND6520 04-04	1/4	1/4	0.606	0.500	0.709	0.472	0.807	0.354	0.551
ND6520 04-06	1/4	3/8	0.606	0.500	0.689	0.472	0.807	0.354	0.748
ND6520 04-08	1/4	1/2	0.606	0.500	0.876	0.610	0.807	0.354	0.866
ND6520 06-02	3/8	1/8	0.787	0.650	0.787	0.315	1.043	0.512	0.551
ND6520 06-04	3/8	1/4	0.787	0.650	0.827	0.472	1.043	0.512	0.551
ND6520 06-06	3/8	3/8	0.787	0.650	0.807	0.472	1.043	0.512	0.748
ND6520 06-08	3/8	1/2	0.787	0.650	0.886	0.610	1.043	0.512	0.866
ND6520 06-12*	3/8	3/4	0.787	0.650	0.886	0.610	1.043	0.512	1.063
ND6520 08-04	1/2	1/4	0.787	0.768	0.886	0.472	1.102	0.591	0.669
ND6520 08-06	1/2	3/8	0.787	0.768	0.846	0.472	1.102	0.591	0.748
ND6520 08-08	1/2	1/2	0.787	0.768	0.925	0.610	1.102	0.591	0.866
ND6520 08-12	1/2	3/4	0.787	0.768	0.925	0.610	1.102	0.591	1.063
ND6520 10-06	5/8	3/8	0.976	0.984	1.063	0.472	1.378	0.787	0.866
ND6520 10-08	5/8	1/2	0.976	0.984	1.122	0.610	1.378	0.787	0.866
ND6520 12-06*	3/4	3/8	1.094	1.122	1.043	0.472	1.437	0.945	0.945
ND6520 12-08	3/4	1/2	1.094	1.122	1.181	0.610	1.437	0.945	0.945
ND6520 12-12	3/4	3/4	1.094	1.122	1.181	0.610	1.437	0.945	1.063

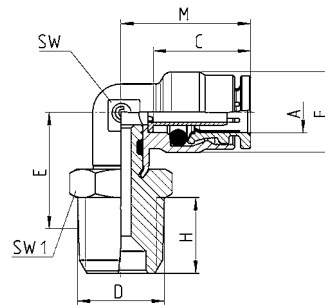

ND6520

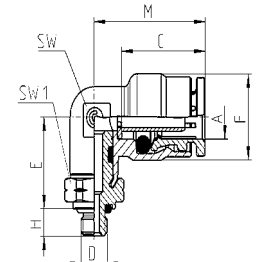

ND6522

*Produced Upon Request
Contact Camozzi USA for Availability

Fittings Model ND6500

Male Non-Swivel Elbow

DIMENSIONS (in inches)

Model	A OD	D NPTF	C	F	E	H	M	SW
ND6500 04-02	1/4	1/8	0.606	0.500	0.472	0.354	0.807	0.354
ND6500 04-04	1/4	1/4	0.606	0.500	0.472	0.472	0.807	0.354
ND6500 04-06	1/4	3/8	0.606	0.500	0.531	0.512	0.906	0.472
ND6500 04-08*	1/4	1/2	0.606	0.500	0.728	0.630	0.807	0.591
ND6500 06-02	3/8	1/8	0.787	0.650	0.531	0.335	1.043	0.512
ND6500 06-04	3/8	1/4	0.787	0.650	0.551	0.492	1.043	0.512
ND6500 06-06	3/8	3/8	0.787	0.650	0.512	0.472	1.043	0.512
ND6500 06-08	3/8	1/2	0.787	0.650	0.728	0.630	1.063	0.591
ND6500 08-04	1/2	1/4	0.787	0.768	0.610	0.492	1.102	0.591
ND6500 08-06	1/2	3/8	0.787	0.768	0.571	0.492	1.102	0.591
ND6500 08-08	1/2	1/2	0.787	0.768	0.728	0.630	1.102	0.591
ND6500 08-12*	1/2	3/4	0.787	0.768	0.827	0.630	1.102	0.945
ND6500 10-06	5/8	3/8	0.976	0.984	0.689	0.492	1.378	0.787
ND6500 10-08	5/8	1/2	0.976	0.984	0.748	0.610	1.378	0.787
ND6500 12-06*	3/4	3/8	1.094	1.122	0.768	0.492	1.437	0.945
ND6500 12-08	3/4	1/2	1.094	1.122	0.827	0.630	1.437	0.945
ND6500 12-12	3/4	3/4	1.094	1.122	0.827	0.630	1.437	0.945

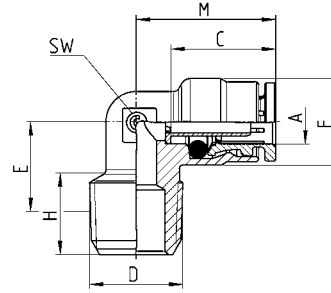

*Produced Upon Request
Contact Camozzi USA for Availability

Fittings Model ND6523

Female Swivel Elbow

DIMENSIONS (in inches)

Mod.	A OD	D NPTF	C	F	H	L	M	SW	SW1
ND6523 53-02	5/32	1/8	0.520	0.354	0.276	0.787	0.689	0.315	0.512
ND6523 53-04	5/32	1/4	0.520	0.354	0.394	0.945	0.689	0.315	0.669
ND6523 04-02	1/4	1/8	0.606	0.500	0.276	0.827	0.807	0.354	0.512
ND6523 04-04	1/4	1/4	0.606	0.500	0.394	0.984	0.807	0.354	0.669
ND6523 04-06	1/4	3/8	0.606	0.500	0.413	0.984	0.807	0.354	0.787
ND6523 06-02*	3/8	1/8	0.787	0.650	0.276	0.945	1.043	0.512	0.551
ND6523 06-04	3/8	1/4	0.787	0.650	0.394	1.102	1.043	0.512	0.669
ND6523 06-06	3/8	3/8	0.787	0.650	0.413	1.122	1.043	0.512	0.787
ND6523 06-08*	3/8	1/2	0.787	0.650	0.551	1.299	1.043	0.512	0.945
ND6523 08-04	1/2	1/4	0.787	0.650	0.394	1.122	1.102	0.591	0.669
ND6523 08-06	1/2	3/8	0.787	0.768	0.413	1.181	1.102	0.591	0.787
ND6523 08-08	1/2	1/2	0.787	0.768	0.551	1.339	1.102	0.591	0.945
ND6523 10-08	5/8	1/2	0.976	0.984	0.551	1.555	1.378	0.787	0.945

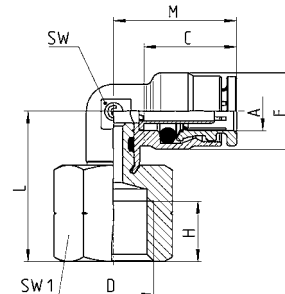

*Produced Upon Request
Contact Camozzi USA for Availability

Fittings Model ND6503

Female Non-Swivel Elbow

All Models are Produced Upon Request
Contact Camozzi USA for Availability

DIMENSIONS (in inches)

Mod.	A OD	D NPTF	C	E	F	G	H	M	SW
ND6503 04-02	1/4	1/8	0.606	0.709	0.500	0.512	0.276	0.807	0.354
ND6503 04-04	1/4	1/4	0.606	0.886	0.500	0.650	0.394	0.906	0.512
ND6503 04-06	1/4	3/8	0.606	1.102	0.587	0.787	0.413	0.906	0.591
ND6503 06-02	3/8	1/8	0.787	0.748	0.650	0.512	0.276	1.043	0.512
ND6503 06-04	3/8	1/4	0.787	0.886	0.650	0.650	0.394	1.043	0.512
ND6503 06-06	3/8	3/8	0.787	1.102	0.650	0.787	0.413	1.063	0.591
ND6503 08-04	1/2	1/4	0.787	0.945	0.768	0.650	0.394	1.102	0.591
ND6503 08-06	1/2	3/8	0.787	1.102	0.768	0.787	0.413	1.102	0.591
ND6503 08-08	1/2	1/2	0.787	1.260	0.768	0.945	0.551	1.142	0.787

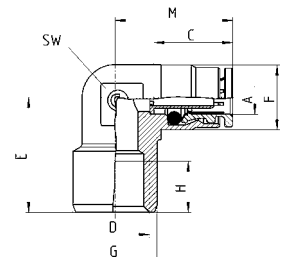

Fittings Model ND6110

Male Swivel 45° Connector

DIMENSIONS (in inches)

Mod.	A OD	D NPTF	C	F	E	H	L	M	SW	SW1
ND6110 04-02	1/4	1/8	0.606	0.500	0.630	0.315	1.555	0.827	0.433	0.472
ND6110 04-04	1/4	1/4	0.606	0.500	0.669	0.472	1.713	0.827	0.433	0.551
ND6110 04-06	1/4	3/8	0.606	0.500	0.650	0.472	1.732	0.827	0.433	0.748
ND6110 06-04	3/8	1/4	0.787	0.650	0.709	0.472	1.969	1.063	0.591	0.669
ND6110 06-06	3/8	3/8	0.787	0.650	0.669	0.472	1.969	1.063	0.591	0.748
ND6110 06-08	3/8	1/2	0.787	0.650	0.748	0.610	2.126	1.063	0.591	0.866
ND6110 08-06	1/2	3/8	0.787	0.768	0.669	0.472	2.028	1.102	0.591	0.748
ND6110 08-08	1/2	1/2	0.787	0.768	0.748	0.610	2.185	1.102	0.591	0.866
ND6110 10-08	5/8	1/2	0.976	0.984	0.945	0.610	2.638	1.398	0.906	0.945
ND6110 12-12	3/4	3/4	1.094	1.122	0.945	0.610	2.717	1.437	0.906	1.063

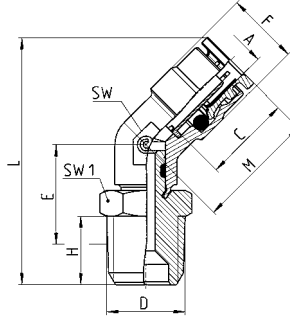

Fittings Model ND6100

Male Non-Swivel 45° Connector

DIMENSIONS (in inches)

Mod.	A OD	D NPTF	C	F	E	H	L	M	SW
ND6100 04-02*	1/4	1/8	0.606	0.500	0.413	0.335	1.327	0.827	0.433
ND6100 04-04*	1/4	1/4	0.606	0.500	0.453	0.472	1.484	0.827	0.433
ND6100 06-02*	3/8	1/8	0.787	0.650	0.492	0.335	1.634	1.063	0.591
ND6100 06-04*	3/8	1/4	0.787	0.650	0.512	0.492	1.772	1.063	0.591
ND6100 06-06*	3/8	3/8	0.787	0.650	0.453	0.433	1.752	1.063	0.591
ND6100 06-08*	3/8	1/2	0.787	0.650	0.531	0.591	1.909	1.063	0.591
ND6100 08-04*	1/2	1/4	0.787	0.768	0.512	0.492	1.831	1.102	0.591
ND6100 08-06*	1/2	3/8	0.787	0.768	0.453	0.433	1.811	1.102	0.591
ND6100 08-08*	1/2	1/2	0.787	0.768	0.531	0.591	1.969	1.102	0.591
ND6100 10-06*	5/8	3/8	0.976	0.984	0.630	0.492	2.248	1.398	0.906
ND6100 10-08*	5/8	1/2	0.976	0.984	0.689	0.630	2.386	1.398	0.906
ND6100 12-08*	3/4	1/2	1.094	1.122	0.689	0.630	2.469	1.437	0.906
ND6100 12-12*	3/4	3/4	1.094	1.122	0.709	0.610	2.488	1.437	0.906

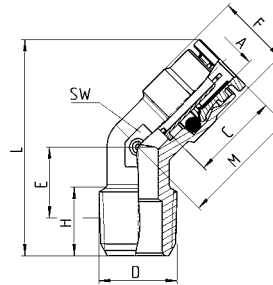

*Produced Upon Request
Contact Camozzi USA for Availability

Fittings Model ND6450

Male Swivel "Y"

DIMENSIONS (in inches)

Mod.	A OD	D NPTF	C	F	H	L	M	SW1
ND6450 53-02	5/32	1/8	0.520	0.709	0.315	1.358	0.354	0.472
ND6450 04-02	1/4	1/8	0.606	0.965	0.315	1.496	0.492	0.472
ND6450 04-04	1/4	1/4	0.606	0.965	0.472	1.535	0.492	0.551
ND6450 06-04	3/8	1/4	0.787	1.260	0.472	2.067	0.630	0.669
ND6450 08-06	1/2	3/8	0.787	1.575	0.472	2.106	0.748	0.748
ND6450 08-08	1/2	1/2	0.787	1.575	0.610	2.185	0.748	0.866

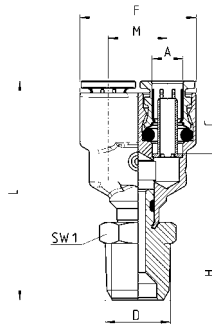

Fittings Model ND6420

Male Non-Swivel Run Tee

DIMENSIONS (in inches)

Mod.	A OD	D NPTF	C	F	E	H	L	M	SW
ND6420 04-02*	1/4	1/8	0.606	0.500	0.472	0.413	1.457	0.807	0.354
ND6420 04-04*	1/4	1/4	0.606	0.500	0.472	0.492	1.575	0.807	0.433
ND6420 06-04*	3/8	1/4	0.787	0.650	0.551	0.492	1.890	1.043	0.512
ND6420 06-06*	3/8	3/8	0.787	0.650	0.571	0.492	1.969	1.063	0.591
ND6420 06-08*	3/8	1/2	0.787	0.650	0.650	0.630	2.126	1.063	0.669
ND6420 08-04*	1/2	1/4	0.787	0.768	0.610	0.492	2.008	1.102	0.591
ND6420 08-06*	1/2	3/8	0.787	0.768	0.571	0.492	2.008	1.102	0.591

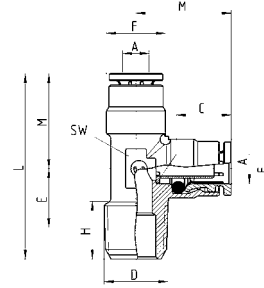

*Produced Upon Request
Contact Camozzi USA for Availability

Fittings Model ND6430

Male Swivel Branch Tee

DIMENSIONS (in inches)

Mod.	A OD	D NPTF	C	F	E	H	L	M	N	SW	SW1
ND6430 53-02	5/32	1/8	0.520	0.354	0.650	0.315	1.378	0.689	0.827	0.315	0.472
ND6430 53-04	5/32	1/4	0.520	0.354	0.689	0.472	1.378	0.689	0.984	0.315	0.551
ND6430 04-02	1/4	1/8	0.606	0.500	0.669	0.315	1.614	0.807	0.846	0.354	0.472
ND6430 04-04	1/4	1/4	0.606	0.500	0.709	0.472	1.614	0.807	1.004	0.354	0.551
ND6430 04-06	1/4	3/8	0.606	0.500	0.689	0.472	1.614	0.807	1.024	0.354	0.748
ND6430 06-02	3/8	1/8	0.787	0.650	0.787	0.315	2.087	1.043	0.965	0.512	0.472
ND6430 06-04	3/8	1/4	0.787	0.650	0.827	0.472	2.087	1.043	1.122	0.512	0.551
ND6430 06-06	3/8	3/8	0.787	0.650	0.807	0.472	2.087	1.043	1.142	0.512	0.748
ND6430 06-08	3/8	1/2	0.787	0.650	0.886	0.610	2.087	1.043	1.299	0.512	0.866
ND6430 08-04	1/2	1/4	0.787	0.768	0.886	0.472	2.205	1.102	1.181	0.591	0.669
ND6430 08-06	1/2	3/8	0.787	0.768	0.846	0.472	2.205	1.102	1.181	0.591	0.748
ND6430 08-08	1/2	1/2	0.787	0.768	0.925	0.610	2.205	1.102	1.339	0.591	0.866
ND6430 10-06*	5/8	3/8	0.976	0.984	0.984	0.472	2.756	1.378	1.535	0.787	0.866
ND6430 10-08	5/8	1/2	0.976	0.984	1.122	0.610	2.756	1.378	1.535	0.787	0.866

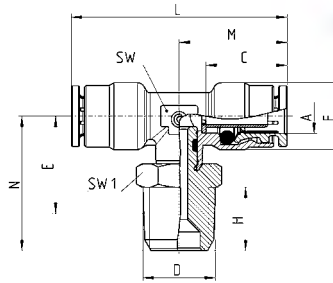

*Produced Upon Request
Contact Camozzi USA for Availability

Fittings Model ND6410

Male Non-Swivel Branch Tee

DIMENSIONS (in inches)

Mod.	A OD	D NPTF	C	F	E	H	L	M	SW
ND6410 04-02*	1/4	1/8	0.606	0.500	0.472	0.413	1.614	0.807	0.354
ND6410 04-04*	1/4	1/4	0.606	0.500	0.472	0.472	1.614	0.807	0.433
ND6410 04-06*	1/4	3/8	0.606	0.512	0.610	0.472	1.614	0.807	0.512
ND6410 06-02*	3/8	1/8	0.787	0.650	0.531	0.335	2.087	1.043	0.512
ND6410 06-04*	3/8	1/4	0.787	0.650	0.551	0.492	2.087	1.043	0.512
ND6410 06-06*	3/8	3/8	0.787	0.650	0.571	0.492	2.126	1.063	0.591
ND6410 06-08*	3/8	1/2	0.787	0.650	0.650	0.630	2.283	1.142	0.669
ND6410 08-04*	1/2	1/4	0.787	0.768	0.610	0.492	2.205	1.102	0.591
ND6410 08-06*	1/2	3/8	0.787	0.768	0.571	0.492	2.205	1.102	0.591
ND6410 08-08*	1/2	1/2	0.787	0.768	0.650	0.630	2.283	1.142	0.669

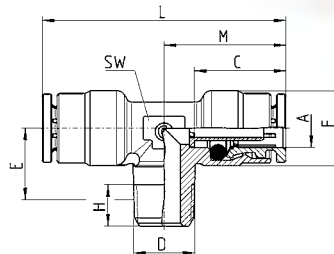

*Produced Upon Request
Contact Camozzi USA for Availability

Fittings Model ND6440

Male Swivel Run Tee

DIMENSIONS (in inches)

Mod.	A OD	D NPTF	C	F	E	H	L	M	SW	SW1
ND6440 53-02	5/32	1/8	0.520	0.354	0.650	0.315	1.516	0.689	0.315	0.472
ND6440 53-04	5/32	1/4	0.520	0.354	0.689	0.472	1.673	0.689	0.315	0.551
ND6440 04-02	1/4	1/8	0.606	0.500	0.669	0.315	1.654	0.807	0.354	0.472
ND6440 04-04	1/4	1/4	0.606	0.500	0.709	0.472	1.811	0.807	0.354	0.551
ND6440 04-06	1/4	3/8	0.606	0.500	0.689	0.472	1.831	0.807	0.354	0.748
ND6440 04-08*	1/4	1/2	0.606	0.500	0.826	0.472	1.988	0.807	0.354	0.866
ND6440 06-04	3/8	1/4	0.787	0.650	0.827	0.472	2.165	1.043	0.512	0.551
ND6440 06-06	3/8	3/8	0.787	0.650	0.807	0.472	2.185	1.043	0.512	0.748
ND6440 06-08	3/8	1/2	0.787	0.650	0.886	0.610	2.343	1.043	0.512	0.866
ND6440 08-04	1/2	1/4	0.787	0.768	0.886	0.472	2.283	1.102	0.591	0.669
ND6440 08-06	1/2	3/8	0.787	0.768	0.846	0.472	2.283	1.102	0.591	0.748
ND6440 08-08	1/2	1/2	0.787	0.768	0.925	0.610	2.441	1.102	0.591	0.866
ND6440 10-08	5/8	1/2	0.976	0.984	1.122	0.610	2.913	1.378	0.787	0.866

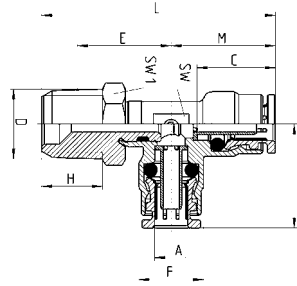

*Produced Upon Request
Contact Camozzi USA for Availability

Fittings Model ND6433

Female Swivel Branch Tee

DIMENSIONS (in inches)

Mod.	A OD	D NPTF	C	F	H	L	M	N	SW	SW1
ND6433 04-04*	1/4	1/4	0.606	0.500	0.394	1.614	0.807	0.827	0.354	0.669
ND6433 06-04*	3/8	1/4	0.787	0.650	0.394	2.087	1.043	1.102	0.512	0.669
ND6433 06-06*	3/8	3/8	0.787	0.650	0.413	2.087	1.043	1.122	0.512	0.787
ND6433 08-04*	1/2	1/4	0.787	0.768	0.394	2.205	1.102	1.122	0.591	0.669
ND6433 08-06*	1/2	3/8	0.787	0.768	0.413	2.205	1.102	1.181	0.591	0.787
ND6433 08-08*	1/2	1/2	0.787	0.768	0.551	2.205	1.102	1.339	0.591	0.945

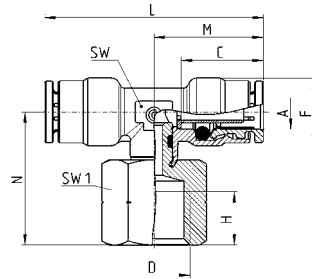

*Produced Upon Request
Contact Camozzi USA for Availability

Fittings Model ND6413

Female Non-Swivel Branch Tee

DIMENSIONS (in inches)

Mod.	A OD	D NPTF	C	E	F	G	H	L	M	SW
ND6413 04-02*	1/4	1/8	0.606	0.669	0.500	0.512	0.276	1.614	0.807	0.433
ND6413 04-04*	1/4	1/4	0.606	0.885	0.591	0.650	0.394	1.811	0.906	0.591
ND6413 06-04*	3/8	1/4	0.787	0.885	0.650	0.650	0.394	2.126	1.063	0.591
ND6413 06-06*	3/8	3/8	0.787	1.024	0.650	0.787	0.413	2.205	1.102	0.669

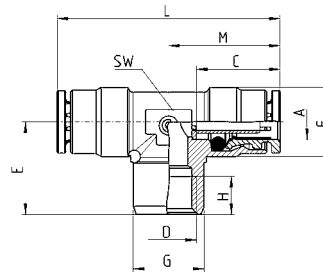

*Produced Upon Request
Contact Camozzi USA for Availability

Fittings Model ND6593

Female Bulkhead

DIMENSIONS (in inches)

Mod.	A OD	D NPTF	B	C	G	H	K (MAX)	K (MIN)	L	SW	SW1
ND6593 53-04*	5/32	1/4	M10X1	0.520	0.776	0.394	0.335	0.079	1.122	0.551	0.669
ND6593 04-02*	1/4	1/8	M14X1	0.606	0.776	0.276	0.394	0.079	1.024	0.669	0.669
ND6593 04-04*	1/4	1/4	M14X1	0.606	0.776	0.394	0.394	0.079	1.142	0.669	0.669
ND6593 06-04*	3/8	1/4	M18X1	0.787	1.005	0.394	0.531	0.079	1.339	0.866	0.866
ND6593 06-06*	3/8	3/8	M18X1	0.787	1.005	0.413	0.531	0.079	1.358	0.866	0.866
ND6593 06-08*	3/8	1/2	M18X1	0.787	1.096	0.551	0.531	0.079	1.496	0.866	0.945
ND6593 08-06*	1/2	3/8	M22X1	0.787	1.096	0.413	0.492	0.079	1.358	1.063	0.945
ND6593 08-08*	1/2	1/2	M22X1	0.787	1.096	0.551	0.492	0.079	1.496	1.063	0.945

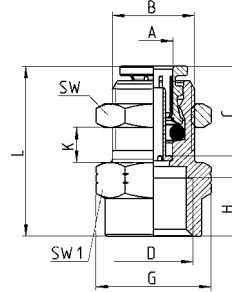

***Produced Upon Request
Contact Camozzi USA for Availability**



Fittings Model ND6463

Female Connector

DIMENSIONS (in inches)

Part No.	A OD	D NPTF	C	F	G	H	L	SW
ND6463 53-02	5/32	1/8	0.520	0.354	0.512	0.276	0.945	0.472
ND6463 53-04	5/32	1/4	0.520	0.354	0.650	0.394	1.102	0.591
ND6463 04-02	1/4	1/8	0.606	0.461	0.512	0.276	1.024	0.472
ND6463 04-04	1/4	1/4	0.606	0.461	0.650	0.394	1.181	0.591
ND6463 04-06*	1/4	3/8	0.606	0.461	0.787	0.413	1.220	0.472
ND6463 06-02	3/8	1/8	0.787	0.606	0.728	0.276	1.201	0.669
ND6463 06-04	3/8	1/4	0.787	0.606	0.728	0.394	1.339	0.669
ND6463 06-06	3/8	3/8	0.787	0.606	0.787	0.413	1.378	0.669
ND6463 06-08*	3/8	1/2	0.787	0.606	0.945	0.551	1.535	0.669
ND6463 06-12*	3/8	3/4	0.787	0.606	1.181	0.551	1.535	0.669
ND6463 08-02*	1/2	1/8	0.787	0.736	0.098	0.276	1.201	0.748
ND6463 08-04	1/2	1/4	0.787	0.736	0.807	0.394	1.339	0.748
ND6463 08-06	1/2	3/8	0.787	0.736	0.807	0.413	1.378	0.748
ND6463 08-08	1/2	1/2	0.787	0.736	0.945	0.551	1.516	0.748
ND6463 08-12*	1/2	3/4	0.787	0.736	1.181	0.551	1.535	0.748
ND6463 10-06*	5/8	3/8	0.976	0.965	0.965	0.413	1.575	0.866
ND6463 10-08	5/8	1/2	0.976	0.925	1.043	0.551	1.732	0.945

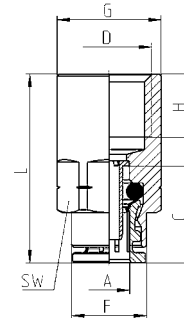

***Produced Upon Request
Contact Camozzi USA for Availability**



Fittings Model ND6580

Union

DIMENSIONS (in inches)

Part No.	A OD	C	F	G	L
ND6580 53-00	5/32	0.520	0.331	0.354	1.142
ND6580 04-00	1/4	0.606	0.461	0.472	1.319
ND6580 06-00	3/8	0.787	0.606	0.650	1.673
ND6580 08-00	1/2	0.787	0.736	0.768	1.673
ND6580 10-00	5/8	0.976	0.925	0.976	2.047
ND6580 12-00	3/4	1.094	1.055	1.094	2.047

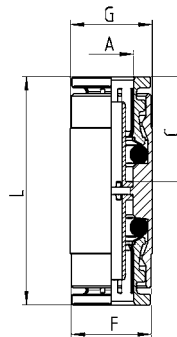

Fittings Model ND6580

Reducing Union

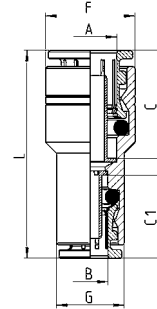
**DIMENSIONS (in inches)**

Part No.	A OD	B	C	C1	F	G	L
ND6580 04-53	1/4	5/32	0.606	0.520	0.472	0.362	1.240
ND6580 06-04	3/8	1/4	0.787	0.606	0.650	0.492	1.516

Fittings Model ND6590

Bulkhead Union

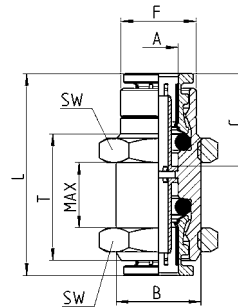
**DIMENSIONS (in inches)**

Part No.	A OD	B	C	F	MAX	L	T	SW
ND6590 53-00	5/32	M10X1	0.520	0.346	0.472	1.142	0.787	0.551
ND6590 04-00	1/4	M14X1	0.606	0.492	0.512	1.319	0.827	0.669
ND6590 06-00	3/8	M18X1	0.787	0.650	0.591	1.673	0.945	0.866
ND6590 08-00	1/2	M22X1	0.787	0.768	0.630	1.673	1.063	1.063
ND6590 10-00	5/8	M26X1	0.976	0.965	0.827	2.047	1.260	1.260

Fittings Model ND6550

Union Elbow

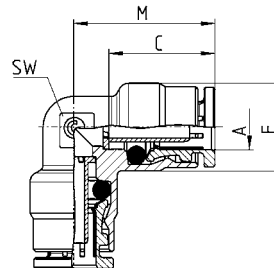
**DIMENSIONS (in inches)**

Part No.	A OD	C	F	M	SW
ND6550 53-00	5/32	0.520	0.354	0.689	0.315
ND6550 04-00	1/4	0.606	0.500	0.807	0.354
ND6550 06-00	3/8	0.787	0.650	1.043	0.512
ND6550 08-00	1/2	0.787	0.768	1.102	0.591
ND6550 10-00	5/8	0.976	0.984	1.378	0.787

Fittings Model ND6540

Union Tee

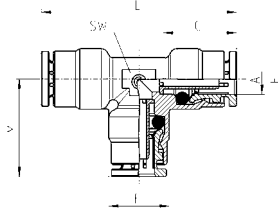

DIMENSIONS (in inches)						
Mod.	A OD	C	F	M	L	SW
ND6540 53-00	5/32	0.520	0.354	0.689	1.378	0.315
ND6540 04-00	1/4	0.606	0.500	0.807	1.614	0.354
ND6540 06-00	3/8	0.787	0.650	1.043	2.086	0.512
ND6540 08-00	1/2	0.787	0.768	1.122	2.204	0.591
ND6540 10-00	5/8	0.976	0.984	1.378	2.756	0.787
ND6540 12-00	3/4	1.094	1.122	1.437	2.874	0.945

Fittings Model ND6540

Reducing Union Tee

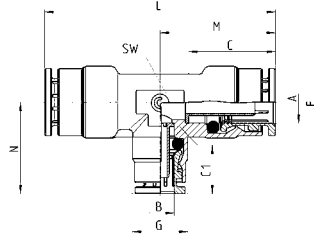

DIMENSIONS (in inches)										
Mod.	A OD	B OD	C	C1	F	G	M	N	L	SW
ND6540 06-06-04	3/8	1/4	0.787	0.606	0.650	0.500	1.043	0.827	2.087	0.512
ND6540 08-08-04*	1/2	1/4	0.787	0.606	0.768	0.500	1.102	0.886	2.205	0.591
ND6540 08-08-06*	1/2	3/8	0.787	0.787	0.768	0.650	1.102	1.102	2.205	0.591

*Produced Upon Request
Contact Camozzi USA for Availability

Fittings Mod. ND6560

Unequal Union "Y"

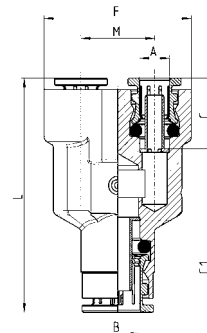

DIMENSIONS (in inches)							
Part No.	A OD	B	C	C1	F	L	M
ND6560 04-06*	1/4	3/8	0.606	0.787	1.260	2.008	0.630
ND6560 06-08*	3/8	1/2	0.787	0.787	1.575	2.244	0.748

*Produced Upon Request
Contact Camozzi USA for Availability

Fittings Model ND6560

Union "Y"

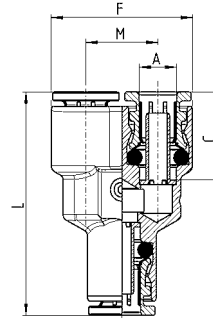

DIMENSIONS (in inches)					
Part No.	A OD	C	F	L	M
ND6560 53-00	5/32	0.520	0.709	1.299	0.354
ND6560 04-00	1/4	0.606	0.965	1.535	0.492
ND6560 06-00	3/8	0.787	1.260	2.146	0.630
ND6560 08-00	1/2	0.787	1.575	2.244	0.748

Fittings Model ND6800

Plug-In Reducer

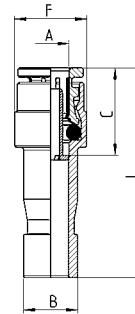

DIMENSIONS (in inches)					
Mod.	A OD	B STEM OD	C	F	L
ND6800 04-06	1/4	3/8	0.606	0.500	1.457

Fittings Model ND6555

Plug-In Elbow

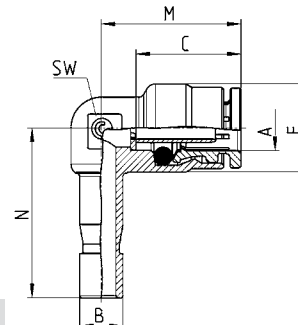

DIMENSIONS (in inches)							
Mod.	A OD	B STEM OD	C	F	M	N	SW
ND6555 04-04	1/4	1/4	0.606	0.500	0.807	0.965	0.354

Fittings Model ND6750

Tube Cap

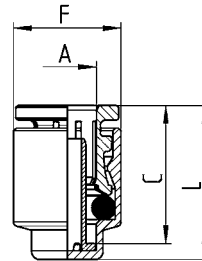

DIMENSIONS (in inches)

Mod.	A OD	C	F	L
ND6750 53-00	5/32	0.520	0.346	0.591
ND6750 04-00	1/4	0.606	0.472	0.610

Fittings Model ND6700

Cartridge



Dimensions

Mod.	Cartridge					Cavity				Installation Tool				
	A OD	C	G	M	L	S (±0.002)	K (min)	H (min)	R	D	E	N	O	P Max (lbs.)
ND6700 53-00	5/32	0.520	0.394	0.413	0.571	0.346	0.059	0.449	0.020	0.346	0.406	0.071	0.150	926
ND6700 04-00	1/4	0.606	0.551	0.480	0.657	0.504	0.079	0.500	0.020	0.465	0.563	0.071	0.169	1102
ND6700 06-00	3/8	0.787	0.701	0.638	0.835	0.650	0.079	0.650	0.020	0.622	0.713	0.071	0.189	2028
ND6700 08-00	1/2	0.787	0.827	0.638	0.835	0.776	0.079	0.780	0.020	0.713	0.839	0.071	0.189	2094

* Cavity dimensions listed above are suitable for non-metallic cavities, however based on the SAE J2494-4 Cartridge Cavity Dimensional Specification, cavities made from materials other than T6061-T6 aluminum may need to be adjusted dimensionally so that when installed; the tube/cartridge/cavity assembly will pass the applicable performance tests in SAE J1131 and SAE J2494-3.

* The dimension for the installation tool should be noted and followed as a properly machined tool creates a specific mechanical stop which serves the purpose of avoiding damage to the collet body due to excessive insertion force being used.

* Surface Finish of the gland seat required: Ra <= 3.2 microns.

* INSTALLATION: Drill or bore hole per specifications per size of cartridge (dimensions H, S, and K).

* Simply press fit cartridge into hole with an evenly distributed force over the top surface.

* Removal of the collet ring is not necessary.

* Cartridge fittings are useful for installations in various manifolds and/or distribution blocks when drilling and tapping are not desirable.

* For cavity specification requirements see SAE J2494-4

Fittings Model 6900...

Plug (Nylon®)

DIMENSIONS (in inches)

Model	G STEM OD	L	P	T
6900 04-00	1/4	1.240	.315	.885
6900 06-00	3/8	1.456	.472	1.063
6900 08-00	1/2	1.594	.630	1.122

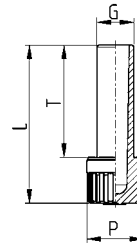

Tubes cutters Model PNZ

Small and Large Tube Cutter

DIMENSIONS (in inches)

Model	Replacement Blade
PNZ-12	able to cut tubes with \emptyset up to 12 mm (1/2") LAME X PNZ-12
PNZ-25	able to cut tubes with \emptyset up to 25 mm (1") LAME X PNZ-25



Plastic tubes cutter Model PNZP-12

DIMENSIONS (in inches)

Model	Replacement Blade
PNZP-12	able to cut tubes with \emptyset till to 12 mm



Fitting Protection Cap Model 6708

Color : Black
Self-extinguishing material, class V0

DIMENSIONS (in mm)

Model	A	F	L	Weight (g)
6708 4	5/32	10.7	10.7	1
6708 6	1/4	13.7	11.5	1
6708 10	3/8	18.5	13	1
6708 12	1/2	20.7	15	2

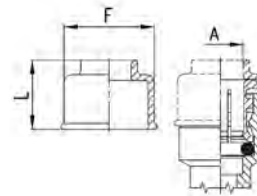

DOT Tubing Model TEA

Color : Black
Meets SAE Specification J844, J1131, J2494-3 and DOT-FMSS 106

DIMENSIONS (in inches)

Model	Outer Diameter	Inner Diameter	Minimum Burst Pressure (psi)	Weight (lb./100ft)	Bend radius (inches)	Length (feet)
TEA 53-BK-PA-1000FT	5/32	.092	1200	.56	1/2	1000
TEA 53-BK-PA-100FT	5/32	.092	1200	.56	1/2	100
TEA 04-BK-PA-1000FT	1/4	.170	1200	1.19	1	1000
TEA 04-BK-PA-100FT	1/4	.170	1200	1.19	1	100
TEA 06-BK-PA-500FT	3/8	.251	1400	2.8	1.5	500
TEA 06-BK-PA-100FT	3/8	.251	1400	2.8	1.5	100
TEA 08-BK-PA-500FT	1/2	.376	950	3.8	2	500
TEA 08-BK-PA-100FT	1/2	.376	950	3.8	2	100
TEA 10-BK-PA-250FT	5/8	.441	900	7	2.5	250
TEA 10-BK-PA-50FT	5/8	.441	900	7	2.5	50
TEA 12-BK-PA-250FT	3/4	.566	800	8.6	3	250
TEA 12-BK-PA-50FT	3/4	.566	800	8.6	3	50



Composite Push-In Fittings Series 7000

Tube Diameter OD : 5/32", 1/4", 5/16", 3/8", 1/2", 4, 6, 8, 10, 12, 16 mm

Thread Type : 10-32 UNF

NPTF 1/8", 1/4", 3/8", 1/2" with Pro-Fit® reusable PTFE seal

Metric (M5, M7)

BSP (G1/8, G1/4, G3/8, G1/2, G3/4), with Spot-Face O-ring Seal

PUSH-IN FITTINGS



Series 7000 push-in composite fittings are compact and lightweight. They offer easy maintenance of the collet and internal o-ring seal. All materials can be easily recycled.

The nickel-plated brass collet maintains the same technical characteristics as the other nickel-plated brass fittings. It provides a uniform grip around the entire surface of the plastic tube. This ensures high reliability and long service life, especially after several connections and disconnections of the tubing.

Series 7000 composite fittings are especially suited to lightweight applications and compact assembly locations, typical in the automation markets.

Pro-Fit® Torque Specifications

Thread Size	Minimum Torque		Maximum Torque	
	N-m	lb-ft	N-m	lb-ft
M5 [10-32 UNF]	0.200	0.148	2.000	1.475
1/8 NPTF or BSP	2.000	1.475	10.000	7.376
1/4 NPTF or BSP	4.000	2.950	20.000	14.751
3/8 NPTF or BSP	5.000	3.688	20.000	14.751
1/2 NPTF or BSP	8.000	5.900	40.000	29.502

GENERAL DATA

Material	body: technopolymer (glass-reinforced Nylon 66 resin); insert: brass, collet: nickel-plated brass; seals: NBR
Threads	1/8", 1/4", 3/8", 1/2" NPTF with Pro-Fit® (Reusable PTFE/Teflon thread seal) GAS cylindrical ISO-228 (BSP)
Operating pressure	min. - 0.9 bar, max. 16 bar, (28" Hg vacuum to 250 psi) (see data for tubing used)
Tube to connect	Nylon 6, 11 or 12, polyethylene, PU (polyurethane recommended 90A durometer and above) Hytel Polyester
Diameters	Tube Diameter OD : 5/32", 1/4", 5/16", 3/8", 1/2", 4 - 6 - 8 - 10 - 12 - 16 mm
Fluid	compressed air (for other types of fluids, contact our engineers)
Temperature	-20° - 60°C (-4 F to 140 F) (see data for tubing used)

Fitting with connecting tube

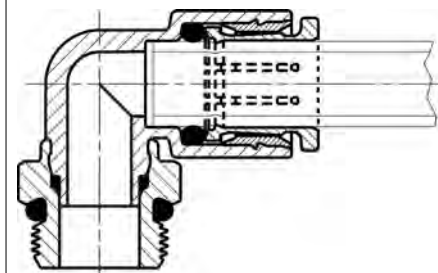

Composite Fittings: Threads with Pro-Fit®, Sprint® or Spot-Face O-Ring Seal

The technical solution: Camozzi has maintained the technically advanced and world-renowned collet solution by further optimizing the dimensions and the design from Series 6000 Fittings and Flow Control Valves.

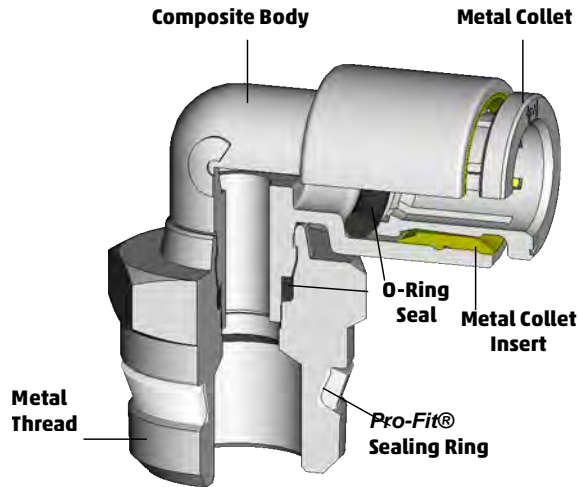

Durable Metal Collet: Nickel-Plated brass collet provides superior resistance to shock, wear and fatigue compared to inferior plastic collets. Proven metal design offers a higher holding force with easier tube release that won't scratch tubing like plastic "bite-ring" designs. Tube OD size is stamped on collet face.

Composite Body: Glass-fiber reinforced, thermoplastic material is incredibly strong and lightweight with improved resistance to UV exposure, abrasion and other chemical substances. Molded composite material allows for integral mounting holes and a broader range of complex shapes.

Pro-Fit® Thread Seal-Ring Design: Reusable Teflon seal reduces assembly time by up to 45% and eliminates exposed threads, making it ideal for food processing, robotics, packaging & manifold assemblies. Eliminates risk of pneumatic system contamination from thread sealants' residue.

Spot-Face O-Ring Thread Seal Design: Reusable Buna-N seal reduces assembly time by up to 45% and eliminates exposed threads, making it ideal for food processing, robotics, packaging & manifold assemblies. Eliminates risk of pneumatic system contamination from sealants' residue.

Features

Collet

- Nickel-Plated, All-metal Collet and Release ring
- Brass insert for collet support and tube grip strength
- Collet design offers greater grip strength under higher pressure or tubing tension
- Collet release mechanism based on relaxed slope of grip teeth, as opposed to disengaging "bite-rings" from partially cut tubes
- Removable Collet and tube o-rings

Body

- Glass-fiber reinforced, thermoplastic compact injection-molded body
- All-Metal, Nickel-Plated Threads
- Standard Buna-N or Specialized O-ring choices for High-Temp, Low-Temp, Special Fluids, Food-Grade compatibility
- Broad Range of shapes and configurations
- Crimp design on Swivels maintains Full ID Flow path
- Swivels offer Mechanical crimping lock based on brass design

Pro-Fit® and Sprint® Thread Design

- Multiple Thread sealant systems: **Pro-Fit®**/NPTF or BSP/**Sprint®**
- Full ID Flow for Swivels with high relief on larger sizes
- Eliminates exposed threads and fits into tight spaces, making them ideal for food processing and hygienic applications.
- Eliminates the need for Teflon® tape or pipe dope. Shorter thread length requires fewer turns to tighten.
- The captured Teflon® sealing ring provides a dependable and reusable shoulder seal without the risk of thread sealant contamination.

Benefits

Collet

- Won't break like plastic release rings, More Durable design
- Brass insert maintains collet stability, tube grip strength and consistent tube-release performance
- Higher holding force, with easier release
- Won't scratch tubes like "bite-ring" designs
- Less chance of micro-leakage and bubble-leaks over time due to damaged tubing
- Higher pressures actually offer greater grip-strength with high-pressure Nylon tubing
- OD Tube Size stamped on Collet face

Body

- Thermoplastic Nylon composite more resistant to UV exposure
- Better resistance to stress-cracking, abrasion, solvents, detergents & hydrocarbons
- 15% Reduction in overall Body size, (24% in Assembly height/ 8% in Tube Radius), compared to recently reduced-size Brass line

Thread Design

- Reduced assembly time without taping of fitting threads
- Re-usable seal design, with no exposed threads
- Simplified manifold circuits with broader variety of fitting combinations and shapes to select
- Lighter weight for End-of-Arm tooling & Robotic handling
- Compact design reduces overall dimensions for valve assemblies, packaging applications and control cabinets

Fittings Model P7524 Pro-Fit® Thread

Swivel elbow.

INCH Tube Fittings

DIMENSIONS (in inches)

Model	A	D	E	G	H	M	SW	
	OD	UNF						
7522 53-32	5/32	10-32	0.335	0.354	0.138	0.669	0.354	•
7522 04-32	1/4	10-32	0.374	0.453	0.138	0.728	0.354	•
	OD	NPTF						
P7524 53-02	5/32	1/8	0.433	0.354	0.197	0.669	0.472	
P7524 53-04	5/32	1/4	0.453	0.354	0.256	0.669	0.551	
P7524 04-02	1/4	1/8	0.472	0.453	0.197	0.728	0.472	
P7524 04-04	1/4	1/4	0.492	0.453	0.256	0.728	0.551	
P7524 04-06	1/4	3/8	0.512	0.453	0.295	0.728	0.748	
P7524 05-02	5/16	1/8	0.531	0.531	0.197	0.807	0.472	
P7524 05-04	5/16	1/4	0.531	0.531	0.256	0.807	0.551	
P7524 06-02	3/8	1/8	0.551	0.630	0.197	0.945	0.551	
P7524 06-04	3/8	1/4	0.591	0.630	0.256	0.945	0.551	
P7524 06-06	3/8	3/8	0.591	0.630	0.295	0.945	0.748	
P7524 06-08	3/8	1/2	0.610	0.630	0.335	0.945	0.866	
P7524 08-04	1/2	1/4	0.630	0.768	0.256	1.102	0.591	
P7524 08-06	1/2	3/8	0.650	0.768	0.295	1.102	0.748	
P7524 08-08	1/2	1/2	0.669	0.768	0.335	1.102	0.866	

INCH Tube Fittings

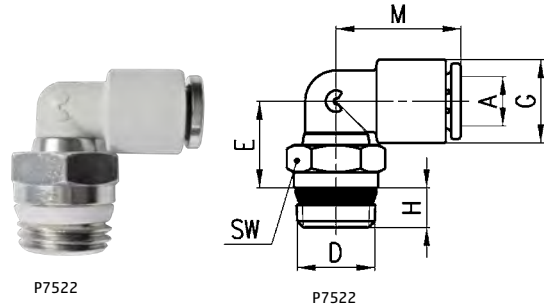

• 10-32 UNF thread seal with O-Ring

Fittings Model 7522

BSP Male Swivel Elbow

METRIC Tube Fittings

DIMENSIONS (in mm)

Model	A	D	E	G	H	M	SW	Weight (g)
7522 4-M5	4	M5	8.5	9.4	3.5	17	9	4
7522 4-M7	4	M7	11	9.4	5	17	12	6
7522 4-1/8	4	G1/8	9	9.4	5	17	12	7
7522 4-1/4	4	G1/4	9	9.4	6	17	14	10
7522 6-M5	6	M5	9.5	11.6	3.5	18.5	9	5
7522 6-M7	6	M7	12	11.6	5	18.5	12	7
7522 6-1/8	6	G1/8	10	11.6	5	18.5	12	8
7522 6-1/4	6	G1/4	10	11.6	6	18.5	14	11
7522 8-1/8	8	G1/8	13.5	13.9	5	20.5	12	11
7522 8-1/4	8	G1/4	12	13.9	6	20.5	14	13
7522 8-3/8	8	G3/8	12.5	13.9	7	20.5	19	21
7522 10-1/4	10	G1/4	14.5	16.1	6	24	14	15
7522 10-3/8	10	G3/8	13.5	16.1	7	24	19	21
7522 10-1/2	10	G1/2	13.5	16.1	8	24	24	30
7522 12-1/4	12	G1/4	16	20.2	6	28	17	20
7522 12-3/8	12	G3/8	15	20.2	7	28	19	25
7522 12-1/2	12	G1/2	15.5	20.2	8	28	24	34
7522 16-1/2	16	G1/2	30	27	8	33.5	24	61
7522 16-3/4	16	G3/4	24	27	9	33.5	30	70

METRIC Tube Fittings

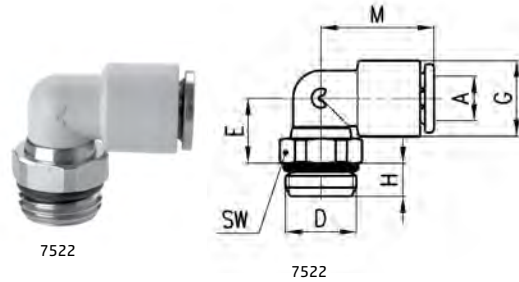

Fittings Model 7526

Extended BSP Male Swivel Elbow

METRIC Tube Fittings

DIMENSIONS (in mm)

Model	A	D	E	G	H	M	SW	Weight (g)
7526 4-1/8	4	G1/8	22	9.4	5	17	12	12
7526 6-1/8	6	G1/8	23	11.6	5	18.5	12	13
7526 6-1/4	6	G1/4	23	11.6	5	18.5	14	16
7526 8-1/8	8	G1/8	29	13.9	5	20.5	12	18
7526 8-1/4	8	G1/4	27	13.9	6	20.5	14	20

METRIC Tube Fittings

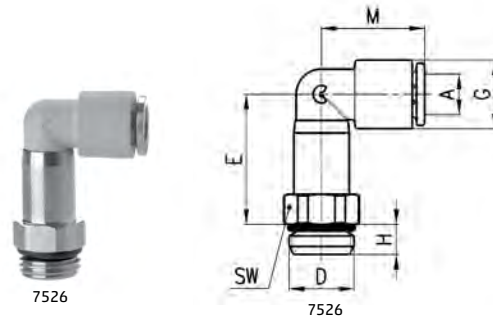

Fittings Model P7624 Pro-Fit®

Banjo Swivel

INCH Tube Fittings

DIMENSIONS (in inches)

Model	A OD	D NPT	E	G	H	L	N	W	SW
P7624 53-02	5/32	1/8	0.413	0.453	0.197	0.984	0.827	0.551	0.157
P7624 04-02	1/4	1/8	0.413	0.453	0.197	0.984	0.827	0.551	0.157
P7624 04-04	1/4	1/4	0.512	0.453	0.256	1.142	0.965	0.728	0.197
P7624 05-04	5/16	1/4	0.512	0.531	0.256	1.142	0.965	0.728	0.197
P7624 06-04	3/8	1/4	0.492	0.630	0.256	1.142	1.063	0.728	0.197
P7624 06-06	3/8	3/8	0.492	0.630	0.295	1.201	1.063	0.728	0.197



P7624

INCH Tube Fittings

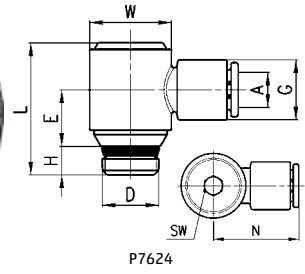

P7624

Fittings Model 7622

Complete BSP Swivel Single Banjo

METRIC Tube Fittings

DIMENSIONS (in mm)

Model	A	D	E	G	H	L	N	W	SW	Weight (g)
7622 4-1/8	4	G1/8	10	11.6	5	24.5	21	14	4	12
7622 6-1/8	6	G1/8	10	11.6	5	24.5	21	14	4	12
7622 6-1/4	6	G1/4	12.5	11.6	6	28	24.5	18.5	5	25
7622 8-1/8	8	G1/8	10	13.9	5	24.5	22.5	14	4	14
7622 8-1/4	8	G1/4	12.5	13.9	6	28	24.5	18.5	5	26
7622 10-1/4	10	G1/4	12.5	16.1	6	28	27	18.5	5	27
7622 10-3/8	10	G3/8	12.5	16.1	7	29	27	18.5	5	28
7622 12-3/8	12	G3/8	14	20.2	7	33.5	29	22	5	43



7622

METRIC Tube Fittings

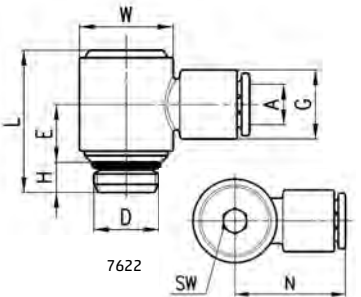

7622

Fittings Model P7654 Pro-Fit®

Double Banjo Swivel

INCH Tube Fittings

DIMENSIONS (in inches)

Model	A OD	D NPT	E	F	G	H	L	M	N	W	SW
P7654 05-04	5/16	1/4	0.512	1.043	0.531	0.256	1.142	0.500	0.965	0.728	0.197



P7654

INCH Tube Fittings

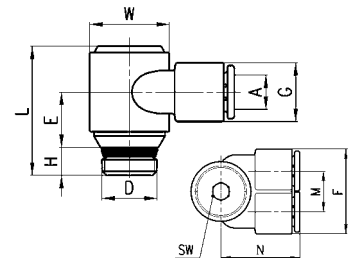

P7654

Fittings Model 7652

Complete BSP Swivel Double Banjo

METRIC Tube Fittings

DIMENSIONS (in mm)

Model	A	D	E	F	G	H	L	M	N	W	SW	Weight (g)
7652 4-1/8	4	G1/8	10	22.3	11.6	5	24.5	10.7	21	14	4	15
7652 6-1/8	6	G1/8	10	22.3	11.6	5	24.5	10.7	21	14	4	15
7652 6-1/4	6	G1/4	11.5	26.6	11.6	6	28	12.7	24.5	18.5	5	29
7652 8-1/8	8	G1/8	10	26.6	13.9	5	24.5	12.7	22	14	4	18
7652 8-1/4	8	G1/4	11.5	26.6	13.9	6	28	12.7	24.5	18.5	5	30
7652 10-1/4	10	G1/4	11.5	31	16	6	28	15	26.5	18.5	5	33
7652 10-3/8	10	G3/8	11.5	31	16	7	29	15	26.5	18.5	5	34



7652

METRIC Tube Fittings

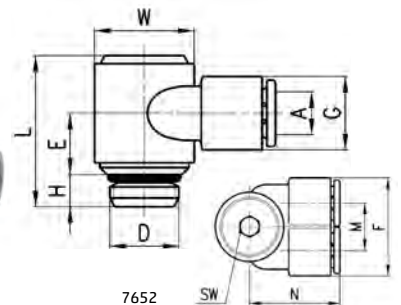

7652

Fittings Model P7434 Pro-Fit® Thread

Male Branch Tee Swivel

INCH Tube Fittings

INCH Tube Fittings							
DIMENSIONS (in inches)							
Model	A OD	D NPT	E	G	H	L	SW
P7434 53-02	5/32	1/8	0.531	0.354	0.197	1.339	0.472
P7434 53-04	5/32	1/4	0.551	0.354	0.256	1.339	0.551
P7434 04-02	1/4	1/8	0.591	0.453	0.197	1.457	0.472
P7434 04-04	1/4	1/4	0.610	0.453	0.256	1.457	0.551
P7434 04-06	1/4	3/8	0.630	0.453	0.295	1.457	0.748
P7434 06-04	3/8	1/4	0.709	0.630	0.256	1.890	0.551
P7434 06-06	3/8	3/8	0.709	0.630	0.295	1.890	0.748
P7434 06-08	3/8	1/2	0.728	0.630	0.335	1.890	0.866
P7434 08-04	1/2	1/4	1.280	0.768	0.256	2.205	0.787
P7434 08-06	1/2	3/8	1.280	0.768	0.295	2.205	0.787
P7434 08-08	1/2	1/2	1.299	0.768	0.335	2.205	0.866



P7434

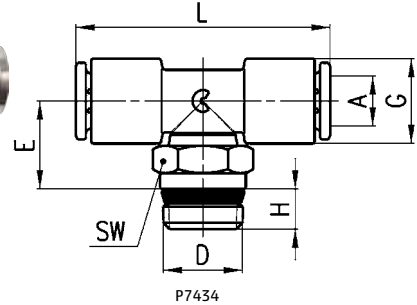

P7434

Fittings Model 7432

BSP Swivel Male Branch Tee

METRIC Tube Fittings

METRIC Tube Fittings									
DIMENSIONS (in mm)									
Model	A	D	E	G	H	L	SW	Weight (g)	
7432 4-M5	4	M5	14	9.4	3.5	34	9	7	
7432 4-1/8	4	G1/8	11.5	9.4	5	34	12	9	
7432 6-M5	6	M5	15.5	11.6	3.5	37	9	9	
7432 6-1/8	6	G1/8	13	11.6	5	37	12	11	
7432 6-1/4	6	G1/4	13	11.6	6	37	14	13	
7432 8-1/8	8	G1/8	16	13.9	5	41	12	15	
7432 8-1/4	8	G1/4	14.5	13.9	6	41	14	17	
7432 8-3/8	8	G3/8	15.5	13.9	7	41	19	25	
7432 10-1/4	10	G1/4	18.5	16.1	6	48	14	21	
7432 10-3/8	10	G3/8	17.5	16.1	7	48	19	27	
7432 12-1/4	12	G1/4	31.5	20.2	6	56	20	49	
7432 12-3/8	12	G3/8	30.5	20.2	7	56	20	51	
7432 12-1/2	12	G1/2	30.5	20.2	8	56	24	58	
7432 16-1/2	16	G1/2	30	27	8	67	24	80	
7432 16-3/4	16	G3/4	24	27	9	67	30	90	



7432

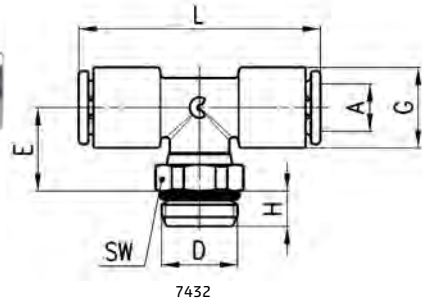

7432

Fittings Model 7562

BSP Swivel Male Y

METRIC Tube Fittings

METRIC Tube Fittings													
DIMENSIONS (in mm)													
Model	A	D	F	H	L	M	S	SW	T	T1	T2	Weight (g)	
7562 4-1/8	4	G1/8	18.5	5	40.5	9	4	12	12.2	11.6	16.5	13	
7562 6-1/8	6	G1/8	23	5	44	11.4	4	14	14.5	14	18.5	15	
7562 6-1/4	6	G1/4	23	6	44	11.4	4	14	14.5	14	17.5	29	
7562 8-1/8	8	G1/8	27.2	5	47.5	13.5	4	14	17	14	17.5	24	
7562 8-1/4	8	G1/4	26.2	6	49	12.7	4	17	16.5	15.5	19.5	30	
7562 10-1/4	10	G1/4	31.7	6	55	15.8	4	17	16.5	16	19.5	32	
7562 10-3/8	10	G3/8	31.7	7	55.5	15.8	4	19	16.5	16	19	34	



7562

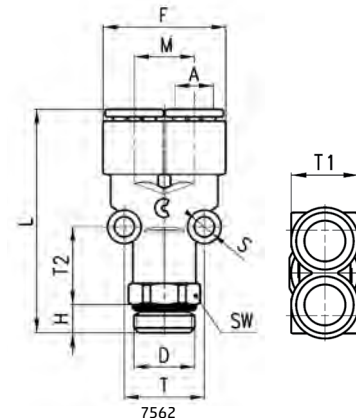

7562

Fittings Model P7444 nd 7442

Male Run Tee Swivel

INCH Tube Fittings									
DIMENSIONS (in inches)									
Model	A OD	D NPT	G	H	L	M	S	T	SW
P7444 53-02	5/32	1/8	0.354	0.197	1.673	0.669	0.157	0.256	0.472
P7444 53-04	5/32	1/4	0.354	0.256	1.850	0.669	0.157	0.256	0.551
P7444 04-02	1/4	1/8	0.453	0.197	1.791	0.728	0.157	0.295	0.472
P7444 04-04	1/4	1/4	0.453	0.256	1.870	0.728	0.157	0.295	0.551
P7444 04-06	1/4	3/8	0.453	0.295	1.929	0.728	0.157	0.295	0.748
P7444 06-04	3/8	1/4	0.630	0.256	2.323	0.945	0.157	0.315	0.551
P7444 06-06	3/8	3/8	0.630	0.295	2.362	0.945	0.157	0.315	0.748
P7444 06-08	3/8	1/2	0.630	0.335	2.421	0.945	0.157	0.315	0.866
P7444 08-04	1/2	1/4	0.768	0.256	2.638	1.102	0.157	0.378	0.591
P7444 08-06	1/2	3/8	0.768	0.295	2.677	1.102	0.157	0.378	0.748
P7444 08-08	1/2	1/2	0.768	0.335	2.736	1.102	0.157	0.378	0.866

METRIC Tube Fittings												
DIMENSIONS (in mm)												
Model	A	D	G	H	L	M	S	T	T1	T2	SW	Weight (g)
7442 4-1/8	4	G1/8	9.4	5	40	16.5	4	13	9.2	6.5	12	11
7442 6-1/8	6	G1/8	11.6	5	44	18.5	4	15	11.4	7.5	12	15
7442 6-1/4	6	G1/4	11.6	6	45	18.5	4	15	11.4	7.5	14	18
7442 8-1/8	8	G1/8	13.9	5	49	20.5	4	17	13.7	8.5	14	23
7442 8-1/4	8	G1/4	13.9	6	49	20.5	4	17	13.7	8.5	17	22
7442 8-3/8	8	G3/8	13.9	7	50.5	20.5	4	17	13.7	8.5	19	29
7442 10-1/4	10	G1/4	16.1	6	57	24	4	16	15.8	8	17	32
7442 10-3/8	10	G3/8	16.1	7	57.5	24	4	16	15.8	8	19	33
7442 12-3/8	12	G3/8	20.2	7	65.5	28	4	19.2	9	9.6	19	51
7442 12-1/2	12	G1/2	20.2	8	66.5	28	4	19.2	9	9.6	24	58
7442 16-1/2	16	G1/2	27	8	71.5	33.5	-	-	-	-	24	80 *
7442 16-3/4	16	G3/4	27	9	66.5	33.5	-	-	-	-	30	90 *



P7444

INCH Tube Fittings

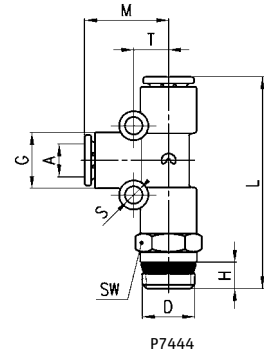

7442

METRIC Tube Fittings

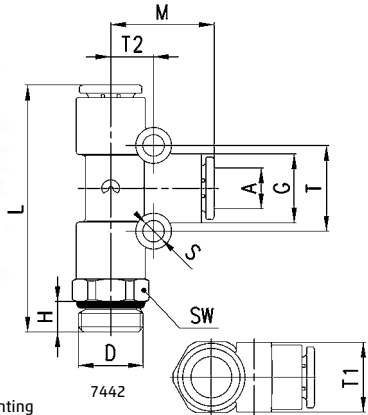

* = model without mounting holes

Fittings Model 7542

Reducing BSP Swivel Male Multi Tee

METRIC Tube Fittings														
DIMENSIONS (in mm)														
Model	A	B	D	G	H	L	M	N	S	SW	T	T1	T2	Weight (g)
7542 6-4-1/8	6	4	G1/8	11.6	5	62.5	9.6	24.5	4	12	32.5	11	7.5	18
7542 6-4-1/4	6	4	G1/4	11.6	6	63.5	9.6	25.5	4	14	32.5	11	7.5	21
7542 8-6-1/8	8	6	G1/8	13.9	5	72	11.5	27.5	4	14	38.2	13.5	9	28
7542 8-6-1/4	8	6	G1/4	13.9	6	72	11.5	27.5	4	14	38.2	13.5	9	26
7542 10-8-1/4	10	8	G1/4	16.1	6	87.5	14.1	31	4	17	45.8	16	10.5	41
7542 10-8-3/8	10	8	G3/8	16.1	7	88	14.1	32	4	19	45.8	16	10.5	42



7542

METRIC Tube Fittings

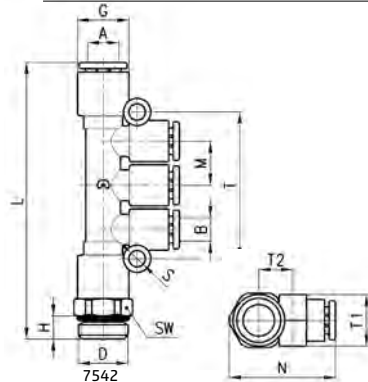

Fittings Model 7572

BSP Swivel Male Double Y

METRIC Tube Fittings													
DIMENSIONS (in mm)													
Model	A	D	H	F	F1	L	M	S	SW	T	T1	T2	Weight (g)
7572 4-1/8	4	G1/8	5	20.5	17	40.5	8.3	4	12	14.5	20.5	15	17
7572 4-1/4	4	G1/4	6	20.5	17	41.5	8.3	4	14	14.5	20.5	15	21
7572 6-1/8	6	G1/8	5	25	21	45.5	10.2	4	14	16.5	25	17.5	27
7572 6-1/4	6	G1/4	6	25	21	45.5	10.2	4	14	16.5	25	16.5	25



7572

METRIC Tube Fittings

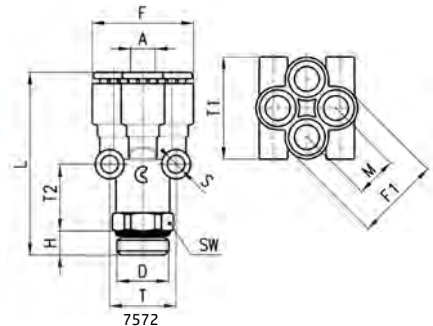

Fittings Model 7580

Union

INCH Tube Fittings

DIMENSIONS (in inches)

Model	A OD	G	L
7580 53-00	5/32	0.354	1.142
7580 04-00	1/4	0.453	1.220
7580 05-00	5/16	0.531	1.319
7580 06-00	3/8	0.630	1.516
7580 08-00	1/2	0.768	1.555

METRIC Tube Fittings

DIMENSIONS (in mm)

Model	A	G	L	Weight (g)
7580 4	4	9.4	29	4
7580 6	6	11.6	31	6
7580 8	8	13.9	33.5	9
7580 10	10	16.1	38.5	11
7580 12	12	20.2	39.5	18

INCH Tube Fittings



7580

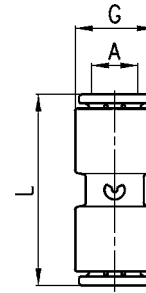

7580

METRIC Tube Fittings



7580

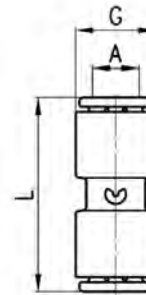

7580

Fittings Model 7550

Union Elbow

INCH Tube Fittings

DIMENSIONS (in inches)

Model	A OD	G	M	S	T
7550 53-00	5/32	0.354	0.669	0.157	0.256
7550 04-00	1/4	0.453	0.728	0.157	0.295
7550 05-00	5/16	0.531	0.807	0.157	0.335
7550 06-00	3/8	0.630	0.945	0.157	0.315
7550 08-00	1/2	0.768	1.102	0.157	0.378

METRIC Tube Fittings

DIMENSIONS (in mm)

Model	A	G	M	S	T1	T2	Weight (g)
7550 4	4	9.4	16.5	4	9.2	6.5	4
7550 6	6	11.6	18.5	4	11.4	7.5	6
7550 8	8	13.9	20.5	4	13.7	8.5	9
7550 10	10	16.1	24	4	15.8	8	12
7550 12	12	20.2	28	4	9	9.6	20
7550 16	16	27	33.5	-	-	-	42 *

INCH Tube Fittings



7550

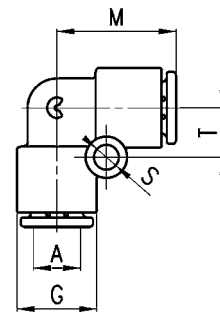

7550

METRIC Tube Fittings



7550

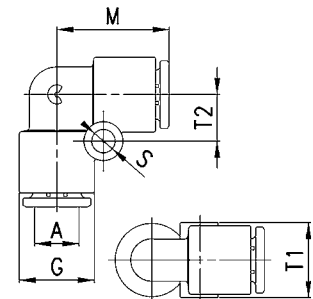

7550

* = model without mounting holes

Fittings Model 7540

Union Tee

INCH Tube Fittings

DIMENSIONS (in inches)

Model	A OD	G	L	M	S	T
7540 53-00	5/32	0.354	1.339	0.669	0.157	0.256
7540 04-00	1/4	0.453	1.457	0.728	0.157	0.295
7540 05-00	5/16	0.531	1.614	0.807	0.157	0.335
7540 06-00	3/8	0.630	1.890	0.945	0.157	0.315
7540 08-00	1/2	0.768	2.205	1.102	0.157	0.378

METRIC Tube Fittings

DIMENSIONS (in mm)

Model	A	G	L	M	S	T	T1	T2	Weight (g)
7540 4	4	9.2	33	16.5	4	13	9.2	6.5	6
7540 6	6	11.6	37	18.5	4	15	11.4	7.5	9
7540 8	8	13.9	41	20.5	4	17	13.7	8.5	14
7540 10	10	16.1	48	24	4	16	15.8	8	18
7540 12	12	20.2	56	28	4	19.2	9	9.6	30
7540 16	16	27	67	33.5	-	-	-	-	61 *



7540

INCH Tube Fittings

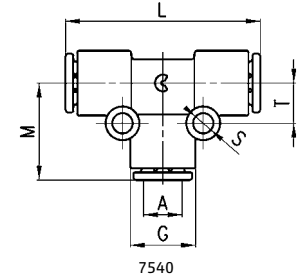

7540

METRIC Tube Fittings

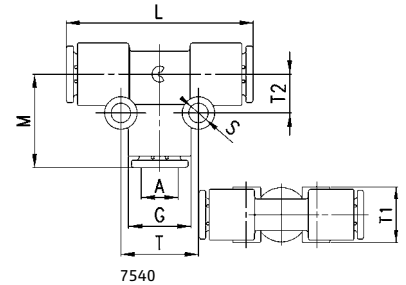

7540

Fittings Model 7800

Plug-in Reducer

INCH Tube Fittings

DIMENSIONS (in inches)

Model	A OD	B OD	G	L1	L
7800 53-04	5/32	1/4	0.354	0.571	1.161
7800 04-06	1/4	3/8	0.453	0.610	1.339
7800 04-08	1/4	1/2	0.453	0.650	1.398
7800 06-08	3/8	1/2	0.630	0.728	1.476

METRIC Tube Fittings

DIMENSIONS (in mm)

Model	A	B	G	L1	L	Weight (g)
7800 4-6	4	6	9.4	14.5	29.5	2
7800 4-8	4	8	9.4	14.5	30.5	3
7800 6-8	6	8	11.6	15.5	31.5	4
7800 6-10	6	10	11.6	15.5	34	4
7800 6-12	6	12	11.6	16.5	35.5	4
7800 8-10	8	10	13.9	16.5	35	5
7800 8-12	8	12	13.9	17.5	37	6
7800 10-12	10	12	16.1	18.5	37.5	7
7800 10-14	10	14	16.1	22.5	39	7



7800

INCH Tube Fittings

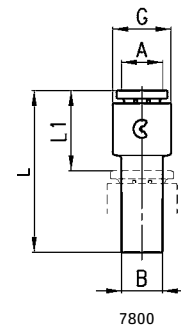

7800

METRIC Tube Fittings

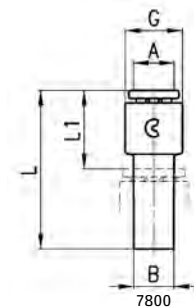

7800

Fittings Model 7555

Plug-In Elbow

INCH Tube Fittings

DIMENSIONS (in inches)

Model	A OD	F	G	L	S	H	B
7555 53-53	5/32	5/32	0.354	0.827	0.276	0.669	0.650
7555 04-04	1/4	1/4	0.453	0.906	0.315	0.728	0.689
7555 05-05	5/16	5/16	0.531	0.984	0.354	0.807	0.728
7555 06-06	3/8	3/8	0.630	1.122	0.394	0.945	0.827
7555 08-08	1/2	1/2	0.768	1.260	0.512	1.102	0.906

METRIC Tube Fittings

DIMENSIONS (in mm)

Model	A	B	G	L	L1	M	T	Weight (g)
7555 4-4	4	4	9.4	21	7	16.5	16.5	2
7555 6-6	6	6	11.6	23	8	18.5	17.5	4
7555 8-8	8	8	13.9	25	9	20.5	18.5	5
7555 10-10	10	10	16.1	28.5	10	24	21	8
7555 12-12	12	12	20.2	32	13	28	23	12

INCH Tube Fittings

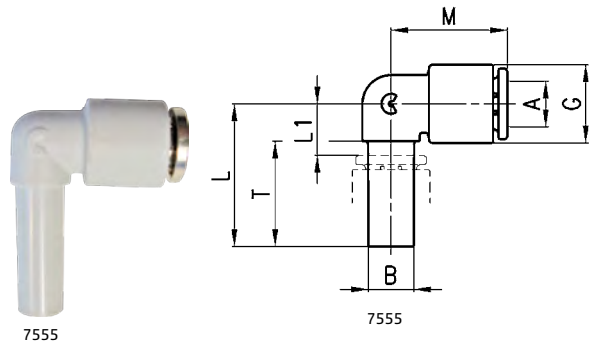

METRIC Tube Fittings

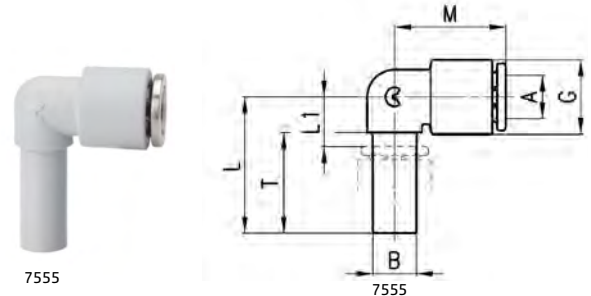

Fittings Model 7950

Double Stem Union

INCH Tube Fittings

DIMENSIONS (in inches)

Model	B OD	L	L1
7950 53-00	5/32	1.457	0.551
7950 04-00	1/4	1.535	0.591
7950 06-00	3/8	1.732	0.728
7950 08-00	1/2	1.929	0.748

METRIC Tube Fittings

DIMENSIONS (in mm)

Model	B	L	L1	Weight (g)
7950 4	4	37	14	1
7950 6	6	39	15	1
7950 8	8	41	16	1
7950 10	10	44	18.5	1
7950 12	12	49	19	1

INCH Tube Fittings

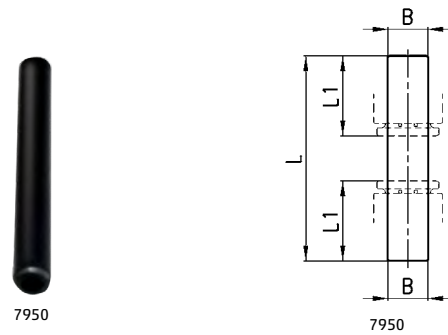

METRIC Tube Fittings

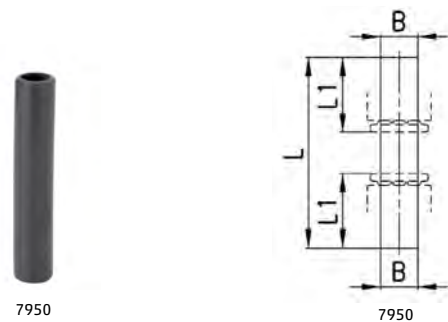

Fittings Model 7560
Reducing Y Union

INCH Tube Fittings

DIMENSIONS (in inches)

Model	A OD	B	F	L	M	S	T	T1	T2
7560 53-00	5/32	5/32	0.669	1.299	0.327	0.157	0.425	0.354	0.512
7560 04-00	1/4	1/4	0.866	1.378	0.421	0.157	0.571	0.433	0.531
7560 05-00	5/16	5/16	1.024	1.555	0.500	0.157	0.669	0.531	0.571

METRIC Tube Fittings

DIMENSIONS (in mm)

Model	A	B	F	L	M	S	T	T1	T2	Weight (g)
7560 4	4	4	18.2	33	9	4	10.8	9.5	13	6
7560 6	6	6	23	35	11.4	4	14.5	11.5	13.5	9
7560 8	8	8	27.2	39.5	13.5	4	17	14	14.5	15
7560 10	10	10	31.7	46	15.8	4	16.5	16	16.5	19
7560 6-4	6	4	18.5	33.5	9	4	12.2	11.6	14.5	7
7560 8-6	8	6	23	36	11.4	4	14.5	14	15.5	11
7560 10-8	10	8	26.2	40	12.7	4	16.5	15.5	16	16



7560

INCH Tube Fittings

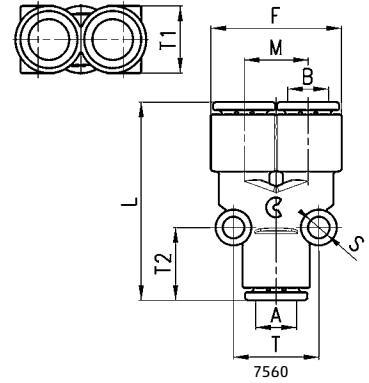

METRIC Tube Fittings

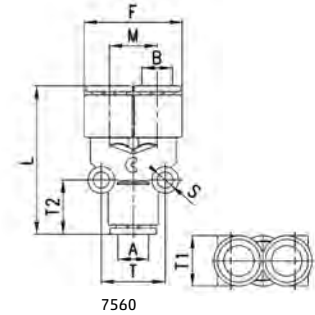

7560

Fittings Model 7575
Reducing Double Y Union

METRIC Tube Fittings

DIMENSIONS (in mm)

Model	A	B	F	F1	L	M	S	T	T1	T2	Weight (g)
7575 6-4	6	4	20.5	17	33.5	8.3	4	14.5	20.5	13.5	12
7575 8-6	8	6	25	21	37	10.2	4	16.5	25	14.5	17



7575

METRIC Tube Fittings

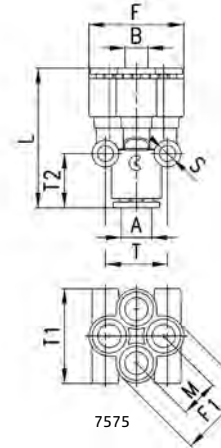

Fittings Model 7545
Reducing Multi Tee

METRIC Tube Fittings

DIMENSIONS (in mm)

Model	A	B	G	L	M	N	S	T	T1	T2	Weight (g)
7545 6-4	6	4	11.6	55.5	9.6	23.5	4	32.5	11	7.5	12
7545 8-6	8	6	13.9	64	11.5	26.5	4	38.2	13.5	9	18
7545 10-8	10	8	16.1	78.5	14.1	30	4	45.8	16	10.5	27

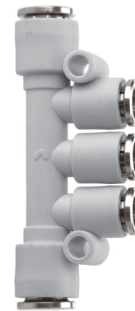

7545

METRIC Tube Fittings

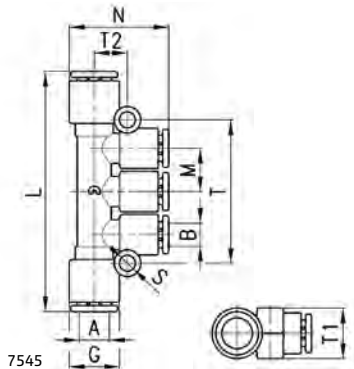

Fittings Model 7610 assembled with Model 7632 02, 7632 03

Single Banjo

DIMENSIONS (in mm)							
Model	A	G	N	O	V	W	Weight
7610 4-1/8	4	11.6	21	15.5	11	14	3
7610 6-1/8	6	11.6	21	15.5	11	14	4
7610 6-1/4	6	13.9	24.5	18.5	15.5	18.5	6
7610 8-1/8	8	13.9	22.5	15.5	11	14	5
7610 8-1/4	8	13.9	24.5	18.5	15.5	18.5	7
7610 10-1/4	10	16.1	27	18.5	15.5	18.5	7
7610 10-3/8	10	20.2	29	22	18	22	11
7610 12-3/8	12	20.2	29	22	18	22	12



METRIC Tube Fittings

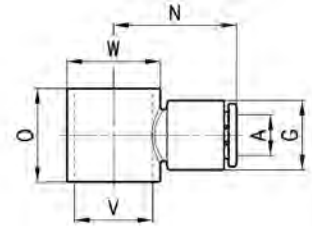

Fittings Model 7640 assembled with Model 7632 02, 7632 0

Double Banjo

METRIC TUBE FITTING									
DIMENSIONS (in mm)									
Model	A	F	G	L	M	N	V	W	Weight (g)
7640 4-1/8	4	22.3	11.6	15.5	10.7	21	11	14	6
7640 6-1/8	6	22.3	11.6	15.5	10.7	21	11	14	7
7640 6-1/4	6	26.6	13.9	18.5	12.7	24.5	15.5	18.5	9
7640 8-1/8	8	26.6	13.9	15.5	12.7	22	11	14	10
7640 8-1/4	8	26.6	13.9	18.5	12.7	24.5	15.5	18.5	10
7640 10-1/4	10	31	16	18.5	15	26.5	15.5	18.5	13



METRIC Tube Fittings

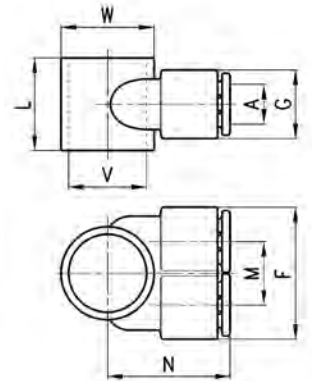

Fittings Model 7632 02 assembled with Model 7610, 7640

Double Banjo Stem

BSP THREADS						
DIMENSIONS (in mm)						
Model	D	H	L	S	SW	Weight (g)
7632 02-1/8	G1/8	5	38.5	15.5	13	14
7632 02-1/4	G1/4	6	46	18.5	17	29
7632 02-3/8	G3/8	7	54	22	20	45

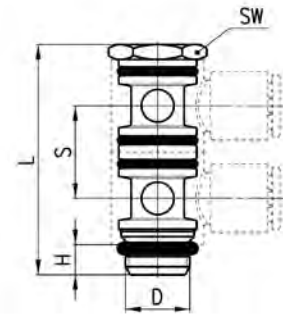

Fittings Model 7632 03 assembled with Model 7610, 7640

Triple Banjo Stem

BSP THREADS						
DIMENSIONS (in mm)						
Model	D	H	L	S	SW	Weight (g)
7632 03-1/8	G1/8	5	54	15.5	13	18
7632 03-1/4	G1/4	6	64.5	18.5	17	39

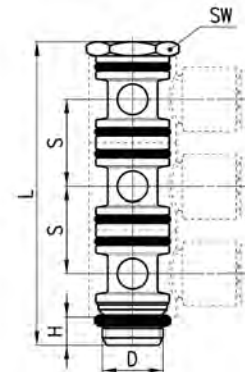

Fittings Model 7612 02
Complete BSP Double Adjustable
Single Banjo

METRIC Tube Fittings

DIMENSIONS (in mm)

Model	A	D	E	G	H	L	N	S	W	SW	Weight (g)
7612 02-4-1/8	4	G1/8	7.75	11.6	5	38.5	21	15.5	14	13	21
7612 02-6-1/8	6	G1/8	7.75	11.6	5	38.5	21	15.5	14	13	21
7612 02-6-1/4	6	G1/4	9.25	13.9	6	46	24.5	18.5	18.5	17	40
7612 02-8-1/8	8	G1/8	7.75	13.9	5	38.5	22.5	15.5	14	13	24
7612 02-8-1/4	8	G1/4	9.25	13.9	6	46	24.5	18.5	18.5	17	42
7612 02-10-1/4	10	G1/4	9.25	16.1	6	46	27	18.5	18.5	17	44
7612 02-10-3/8	10	G3/8	11	20.2	7	54	29	22	22	20	67
7612 02-12-3/8	12	G3/8	11	20.2	7	54	29	22	22	20	69



METRIC Tube Fittings

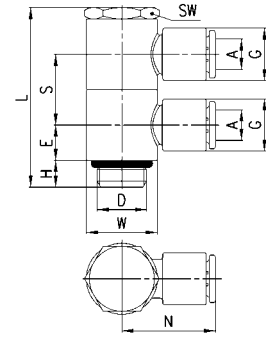

Fittings Model 7612 03
Complete BSP Triple Adjustable
Single Banjo

METRIC Tube Fittings

DIMENSIONS (in mm)

Model	A	D	E	G	H	L	N	S	W	SW	Weight (g)
7612 03-4-1/8	4	G1/8	7.75	11.6	5	54	21	15.5	14	13	29
7612 03-6-1/8	6	G1/8	7.75	11.6	5	54	21	15.5	14	13	30
7612 03-6-1/4	6	G1/4	9.25	13.9	6	64.5	24.5	18.5	18.5	17	55
7612 03-8-1/8	8	G1/8	7.75	13.9	5	54	22.5	15.5	14	13	34
7612 03-8-1/4	8	G1/4	9.25	13.9	6	64.5	24.5	18.5	18.5	17	57
7612 03-10-1/4	10	G1/4	9.25	16.1	6	64.5	27	18.5	18.5	17	62



METRIC Tube Fittings

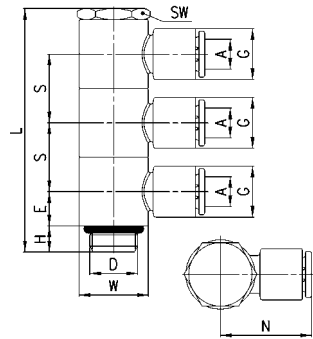

Fittings Model 7642 02
Complete BSP Double Adjustable
Double Banjo

METRIC Tube Fittings

DIMENSIONS (in mm)

Model	A	D	E	F	G	H	L	M	N	S	W	SW	Weight (g)
7642 02-4-1/8	4	G1/8	7.75	22.3	11.6	5	38.5	10.7	21	15.5	14	13	26
7642 02-6-1/8	6	G1/8	7.75	22.3	11.6	5	38.5	10.7	21	15.5	14	13	28
7642 02-6-1/4	6	G1/4	9.25	26.6	13.9	6	46	12.7	24.5	18.5	18.5	17	48
7642 02-8-1/8	8	G1/8	7.75	26.6	13.9	5	38.5	12.7	22	15.5	14	13	33
7642 02-8-1/4	8	G1/4	9.25	26.6	13.9	6	46	12.7	24.5	18.5	18.5	17	50
7642 02-10-1/4	10	G1/4	9.25	31	16	6	46	15	26.5	18.5	18.5	17	56



METRIC Tube Fittings

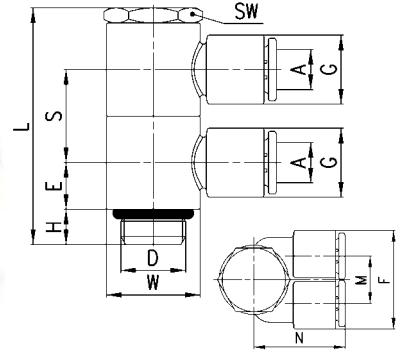

Fittings Model 7642 03
Complete BSP Triple Adjustable
Double Banjo

METRIC Tube Fittings

DIMENSIONS (in mm)

Model	A	D	E	F	G	H	L	M	N	S	W	SW	Weight (g)
7642 03-4-1/8	4	G1/8	7.75	22.3	11.6	5	54	10.7	21	15.5	14	13	37
7642 03-6-1/8	6	G1/8	7.75	22.3	11.6	5	54	10.7	21	15.5	14	13	39
7642 03-6-1/4	6	G1/4	9.25	26.6	13.9	6	64.5	12.7	24.5	18.5	18.5	17	67
7642 03-8-1/8	8	G1/8	7.75	26.6	13.9	5	54	12.7	22.5	15.5	14	13	47
7642 03-8-1/4	8	G1/4	9.25	26.6	13.9	6	64.5	12.7	24.5	18.5	18.5	17	71
7642 03-10-1/4	10	G1/4	9.25	31	16.1	6	64.5	15	27	18.5	18.5	17	79



METRIC Tube Fittings

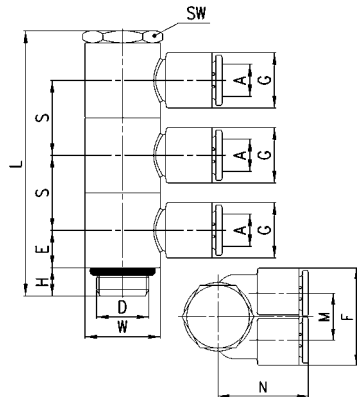

Series 6000LF Push-in Self-Sealing Fittings



Tube external diameters: 4 or 6 mm
Fittings threads: BSP G1/8



Series 6000 super-rapid fittings have been designed with a special collet which provides an homogeneous tight self sealing on the whole surface of plastic tubes, thus ensuring high reliability and a long service life, also after connections and disconnections of the tube are repeated several times. The wide range of these fittings includes many types of threads: metric, BSP and BSPT.

Sprint models are characterized by great reliability of female threads, both BSP and BSPT, with non-flat surfaces. This is possible thanks to a Teflon ring on the male thread, which guarantees a perfect seal between the two threads.

» The "Stop Fitting" model is available with a self-sealing device which interrupts the air flow when the tube is disconnected and restores it when reconnected.

GENERAL DATA

Diameters	ø 4 - 6 mm Micro models: ø 3 - 4 - 6 - 8 - 10 mm
Threads	GAS conical ISO 7 (BSPT) GAS cylindrical ISO 228 (BSP); G1/8
Temperature	-4°F - 176°F (-20°C - 80°C) (see the technical data of tubing used) Micro models: -10°F - 176°F (-10°C - 80°C) (see the technical data of tubing used)
Tube to connect	Rilsan, PA 6-11-12, Polyethylene, PU, Hytrel Polyester
Fluid	compressed air (for other types of fluid, contact our engineers)
Materials	standard models: body and collet in nickel-plated brass, O-Ring in NBR, thread seals in PTFE - NBR - PA models with self-retaining device: body and collet in nickel-plated brass, poppet valve in brass, spring in stainless steel, O-Ring in NBR, thread seals in PTFE
Pressure	standard models: -13 psi - 232 psi (-0.9 bar - max 16 bar) (see tubing) models with self-retaining device: 0 - 232 psi (0 - 16 bar)

Fitting with connecting tube

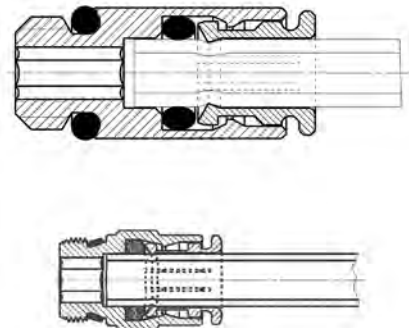

Fittings Mod. S6510...-LF

Male Connector Sprint® with self-sealing device

New

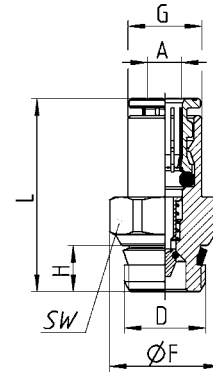

Mod.	A	D	F	G	H	L	SW	weight (g)
S6510 4-1/8-LF	4	G1/8	13.2	8.8	5.5	23	12	11
S6510 6-1/8-LF	6	G1/8	13.2	11.7	6	30.5	12	15

Fittings Mod. 7522...LF

Metric-BSP Male Swivel Elbow with self-sealing device

New

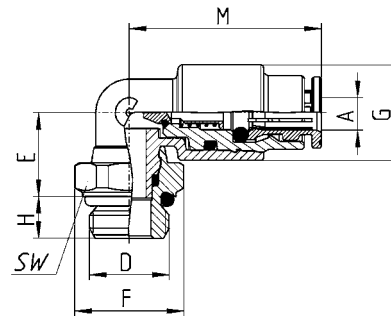

Mod.	A	D	E	F	G	H	M	SW	weight (g)
7522 4-1/8-LF	4	G1/8	10	13	1.6	5	23	12	11
7522 6-1/8-LF	6	G1/8	13.5	13	13.9	5	37.5	12	23

Nickel-Plated Brass High Pressure Push-In Fittings BSP/Metric Series 8000

Tube Diameter OD: 4, 6, 8, 10 and 12 mm

Thread Type: BSP (G1/8 - G1/4 - G3/8 - G1/2), with Spot-Face O-ring Seal



With its vast experience in manufacturing push-in connections for the pneumatics industry and its in-depth research into fluid power systems, Camozzi has developed the Series 8000 super rapid fitting featuring a dual sealing design.

This new series derives from the popular Series 6000, which has been extensively tested in the pneumatic sector. The main characteristic of the Series 8000 is the inclusion of additional seals (patented system) to provide a leak tight and positive connection, and eliminating the possibility of leakage which may occur from tube scoring.

The dual seal super-rapid fittings are available in 6 different models. Connection and disconnection of the tube can be repeated many times without altering the performance of the fitting and without compromising the sealing on the tube. The connect/release operation of the tube, which can be made without the use of tools, allows considerable time saving during installation and maintenance. The BUNA-N seals can be replaced in a simple operation. These fittings are available with tube to tube and threaded connections.

On request these fittings can also be supplied in Viton® and EPDM.

GENERAL DATA

Materials	body and collet: nickel-plated brass seals: NBR
Threads	Gas cylindrical ISO-228 (BSP)
Pressure	min. - 0.9 - max. 60 bar (28" Hg vacuum to 870 psi) The Series 8000 fittings have a working pressure of 60 bar but this would generally be limited by the type of tubing used.
Tube to connect	Nylon 6 - 11 - 12, PU (Polyurethane recommended 90A durometer and above), Hytrel Polyester
Diameters	ø 4, 6, 8, 10, 12
Fluid	All fluids compatible with the fitting's materials requiring a leak-tight seal, e.g. water. For other fluids, please contact our technicians.
Temperature	-20°C - 80°C (-4 F to 175 F)

Fitting with connecting tube

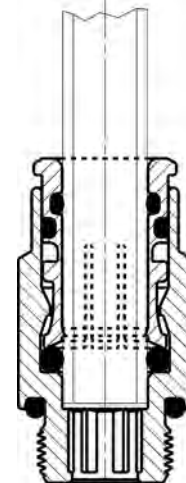

Dual Seal Fittings Series 8000

PATENTED BY CAMOZZI

Possible micro scratches on the tube are eliminated due to 2 o-rings at Sealing Point 2

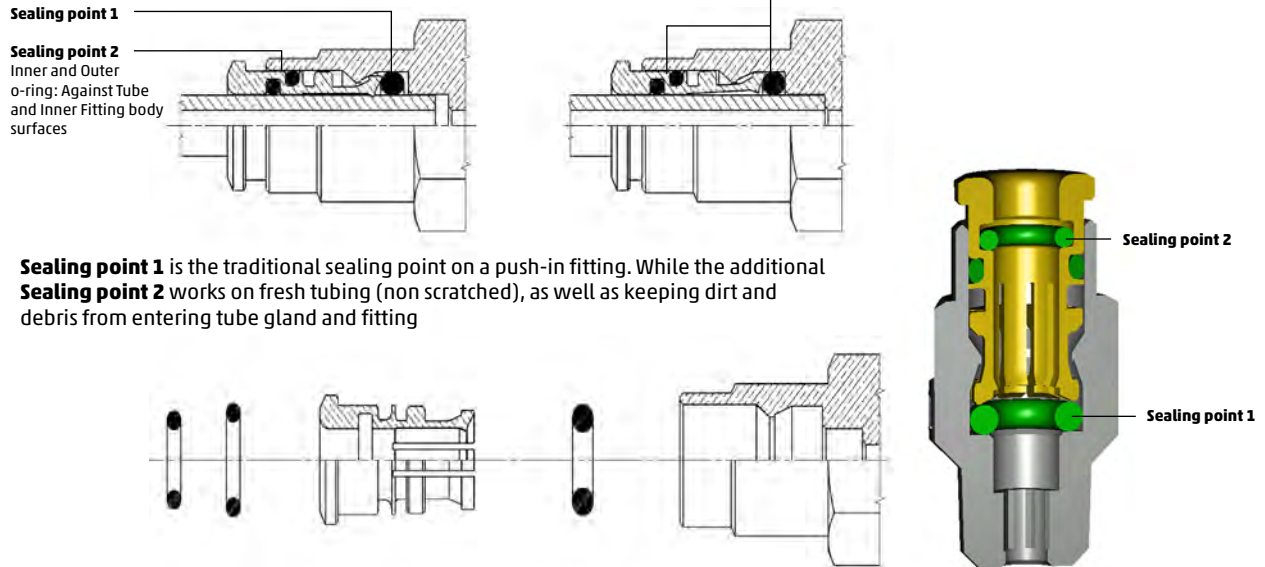

Sealing point 1 is the traditional sealing point on a push-in fitting. While the additional **Sealing point 2** works on fresh tubing (non scratched), as well as keeping dirt and debris from entering tube gland and fitting

Features

- Wide Pressure Range: -0.9 to 60 bar, (28 in Hg – 870 psi)
- All-metal, Nickel-Plated brass body and collet
- Standard Buna-N o-rings can be changed to Viton®, or other materials upon request.
- Longer tube support offered by extra long collet, which holds 3 sealing o-rings
- Compact Brass bodies from Brass forgings
- Proven Collet release system
- No slots or grooves in Collet system exposed to environment
- Triple O-ring Sealing System accepts copper tubing as well as liquid fluid media with no leakage.

Benefits

- Seals at high pressures like DOT fittings, (metric tubing), as well as vacuum.
- Collets won't break like plastic release rings and bodies; More Durable design
- Higher holding force, with easier release
- Won't scratch tubes like "bite-ring" designs
- Less chance of micro-leakage and bubble-leaks over time due to damaged tubing
- Resists "egg-shaping" of tubing in tight bend radius, causing leakage after control panel assembly
- Resistant to UV exposure
- Better resistance to stress-cracking, abrasion, solvents, detergents, hydrocarbons and other fluid media
- Reduced assembly time without taping of threads
- Reusable seal design, with no exposed threads, (Spot-Face O-ring design ensures proper sealing torque)
- No tubing assembly or dis-assembly tools required
- Collet System keeps dirt, debris and other environmental contaminants from entering sealing system causing leaks in other Push-To-Connect systems

Fittings Model 8512

BSP Male Connector

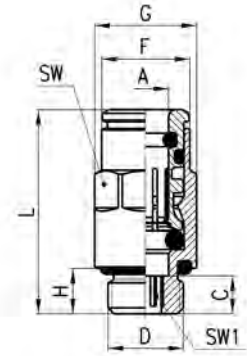

DIMENSIONS (in mm)

Model	A	D	C	F	G	H	L	SW	SW1	Weight (g)
8512 4-1/8	4	G1/8	5	8.8	13.5	6	23.8	12	2.5	14
8512 6-1/8	6	G1/8	5	11.7	13.5	6	27	12	4	15
8512 6-1/4	6	G1/4	6	11.7	16.4	7	28	15	4	25
8512 8-1/8	8	G1/8	8.5	13.7	15.2	6	32.5	14	5	20
8512 8-1/4	8	G1/4	7	13.7	16.4	7	31	15	6	24
8512 10-1/4	10	G1/4	10	16.3	18.5	7	36.5	17	7	32
8512 10-3/8	10	G3/8	4.5	16.3	20.5	7	31	19	8	38
8512 12-3/8	12	G3/8	4.6	18.4	20.5	7	30.5	19	9	30
8512 12-1/2	12	G1/2	5.6	18.4	24.8	8	31.5	22	9	50

Fittings Model 8522

BSP Swivel Male Elbow

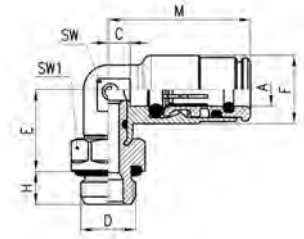

DIMENSIONS (in mm)

Model	A	D	C	E	F	H	M	SW	SW1	Weight (g)
8522 4-1/8	4	G1/8	3	14.5	10	6	21.5	9	12	18
8522 6-1/8	6	G1/8	4	15	12.5	6	26	10	12	23
8522 6-1/4	6	G1/4	4	16	12.5	7	26	10	15	30
8522 8-1/8	8	G1/8	5	16	14.5	6	29	12	12	28
8522 8-1/4	8	G1/4	5	17	14.5	7	29	12	15	34
8522 10-1/4	10	G1/4	5	19.5	16.8	7	31.5	13	15	40
8522 10-3/8	10	G3/8	5	19.5	16.8	7	31.5	13	19	50
8522 12-3/8	12	G3/8	7	20.5	19	7	33	15	19	55
8522 12 1/2	12	G3/8	7	21.5	19	8	33	15	22	68

Fittings Model 8432

BSP Swivel Male Branch Tee

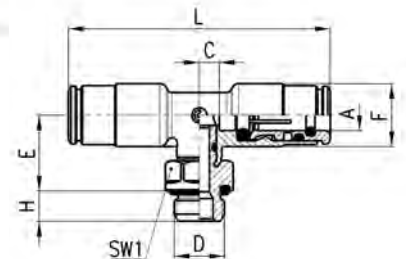

DIMENSIONS (in mm)

Model	A	D	C	E	F	H	L	SW1	Weight (g)
8432 4-1/8	4	G1/8	3	14.5	10	6	43	12	25
8432 6-1/8	6	G1/8	4	15	12.5	6	52	12	33
8432 8-1/8	8	G1/8	5	16	14.5	6	58	12	42
8432 8-1/4	8	G1/4	5	17	14.5	7	58	15	49

Fittings Model 8580

Union

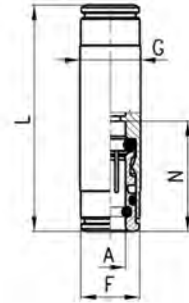

DIMENSIONS (in mm)

Model	A	F	G	L	N	Weight (g)
8580 4	4	8.8	10	38	19	16
8580 6	6	11.7	12	45	22	23
8580 8	8	-	14	48	24	30

Fittings Model 8540

Tee Union

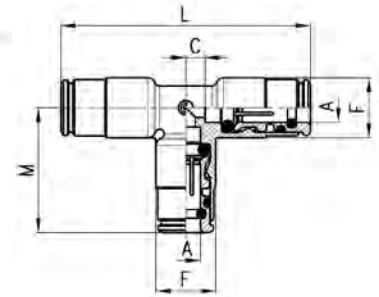

DIMENSIONS (in mm)

Model	A	C	F	M	L	Weight (g)
8540 4	4	3	10	21.5	43	22
8540 6	6	4	12.5	26	52	35
8540 8	8	5	14.5	29	58	49

Fittings Model 8550

Elbow Union

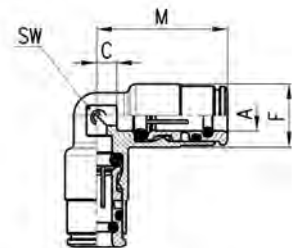

DIMENSIONS (in mm)

Model	A	C	F	M	SW	Weight (g)
8550 4	4	3	10	21.5	9	15
8550 6	6	4	12.5	26	10	25
8550 8	8	5	14.5	29	12	34

Stainless Steel (316L) Push-In Fittings BSP/Metric Series X6000

Tube Diameter OD: 4, 6, 8, 10, 12 mm

Thread Type: BSP (G1/8, G1/4, G3/8, G1/2), with Spot-Face O-ring Seal BSPT
(R1/8, R1/4, R3/8, R1/2)



Series X6000 fittings have been designed to offer versatility and ease of installation without any compromise in quality or performance. They are suitable for applications in the pneumatics, fluids, chemical, medical, food and packaging industries.

Series X6000 fittings are practical and safe and allow the connection of fluids even in aggressive environments.

The collet ensures excellent grip between the fitting and tubing.

GENERAL DATA

Materials	1 = Body	Stainless steel 316L
	2 = Seals	FKM Alimentary (Food Grade Viton)
	3 = Supporting ring	Stainless steel 316L
	4 = Clamping gripper	Stainless steel 301
	5 = Locking bushing	Stainless steel 316L
	6 = Release bushing	Stainless steel 316L
Threads	GAS conical ISO 7 (BSPT)	
	GAS cylindrical ISO 228 (BSP)	
Pressure	max 18 bar (260 psi) (see tubing)	
Tube to connect	Nylon 6, 11 or 12, Polyethylene, PU, Polyester Hytrel	
Diameters	4 - 6 - 8 - 10 - 12 mm	
Fluid	compressed air and drinking water (for other fluids, please contact our technicians)	
Temperature	-15°C - 100°C (5 F to 212 F) (see data for tubing used)	

Fitting with connecting tube

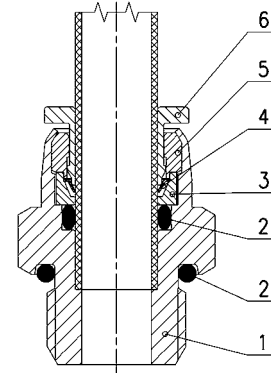

Fittings Model X6510

BSPT Male Connector

DIMENSIONS (in mm)

Model	A	C	D	F	G	H	L	SW	Weight (g)	Package
X6510 4-1/8	4	8	R1/8	9.7	-	8	20.5	10	9	10
X6510 4-1/4	4	10	R1/4	9.7	-	10	22.5	14	15	10
X6510 6-1/8	6	8	R1/8	11.6	13.4	8	21.5	12	10	10
X6510 6-1/4	6	10	R1/4	11.6	15.2	10	23.5	14	17	10
X6510 8-1/8	8	8.5	R1/8	14.7	17	8	24.6	15	16	10
X6510 8-1/4	8	10	R1/4	14.7	17	10	26.1	15	20	10
X6510 10-1/4	10	11	R1/4	17.4	20.8	10	28.2	19	28	10
X6510 10-3/8	10	12	R3/8	17.4	20.8	11	29.2	19	35	10
X6510 10-1/2	10	14	R1/2	17.4	24.6	13	31.2	22	55	10
X6510 12-1/4	12	12	R1/4	20	-	10	31	22	42	10
X6510 12-3/8	12	12.5	R3/8	20	-	11	31.5	22	44	10
X6510 12-1/2	12	14.5	R1/2	20	-	13	33.5	22	59	10

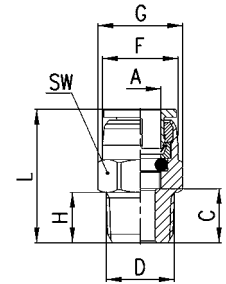

Fittings Model X6512

BSP Male Connector

DIMENSIONS (in mm)

Model	A	C	D	F	G	H	L	SW	Weight (g)	Package
X6512 4-1/8	4	5.7	G1/8	9.7	-	5.7	18.2	14	11	10
X6512 4-1/4	4	6.4	G1/4	9.7	-	6	18.9	17	18	10
X6512 6-1/8	6	6.7	G1/8	11.6	15	5.7	20.2	14	12	10
X6512 6-1/4	6	6.5	G1/4	11.6	-	6	20	17	19	10
X6512 8-1/8	8	8.7	G1/8	14.7	-	5.7	24.8	15	18	10
X6512 8-1/4	8	6	G1/4	14.7	-	6	22.1	17	21	10
X6512 10-1/4	10	8.5	G1/4	17.4	-	6	25.7	19	28	10
X6512 10-3/8	10	6.5	G3/8	17.4	-	6.5	23.7	22	29	10
X6512 10-1/2	10	11.5	G1/2	17.4	30	9.5	28.7	27	60	10
X6512 12-1/4	12	8.5	G1/4	20	-	6	27.5	22	40	10
X6512 12-3/8	12	9	G3/8	20	-	6.5	28	22	42	10
X6512 12-1/2	12	12.5	G1/2	20	30	9.5	31.5	27	71	10

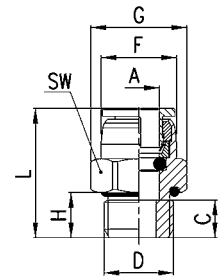

Fittings Model X6580

Union

DIMENSIONS (in mm)

Model	A	F	L	N	Weight (g)	Package
X6580 4	4	10	26.5	12.5	10	10
X6580 6	6	12	28.4	13.5	15	10
X6580 8	8	15	33.7	16.1	26	10
X6580 10	10	18	36.4	17.2	39	10
X6580 12	12	20	41	19	54	10

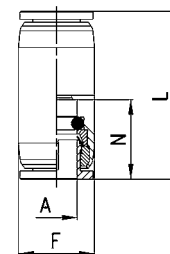

Fittings Model X6590

Bulkhead Union

DIMENSIONS (in mm)

Model	A	B	F	L	N	MAX	SW	Weight (g)	Package
X6590 4	4	M11X1	9.7	29	12.5	6	14	17	10
X6590 6	6	M13X1	11.6	34	13.5	9	17	29	10
X6590 8	8	M16X1	14.7	37.2	16.1	9	19	40	10
X6590 10	10	M19X1	17.4	43.4	17.2	11	22	62	10
X6590 12	12	M22X1	20	50	19	15	27	103	10

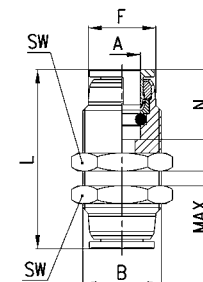

Fittings Model X6500

BSPT Non-Swivel Elbow

DIMENSIONS (in mm)

Model	A	C	D	E	F	H	M	SW	Weight (g)	Package
X6500 4-1/8	4	7.8	R1/8	12.5	11	8	20.3	12	22	10
X6500 6-1/8	6	8.8	R1/8	12.5	11.9	8	22.3	12	20	10
X6500 6-1/4	6	8.8	R1/4	12	11.9	9	22.3	12	24	10
X6500 8-1/8	8	8.4	R1/8	15	15	8	24.5	12	26	10
X6500 8-1/4	8	8.4	R1/4	14	15	10	24.5	12	25	10
X6500 10-1/4	10	8.7	R1/4	15	17.4	10	25.9	14	36	10
X6500 10-3/8	10	8.7	R3/8	15	17.4	10.8	25.9	14	41	10
X6500 12-1/4	12	9.5	R1/4	16	20	10	28.5	17	49	10
X6500 12-3/8	12	9.5	R3/8	16	20	12	28.5	17	55	10

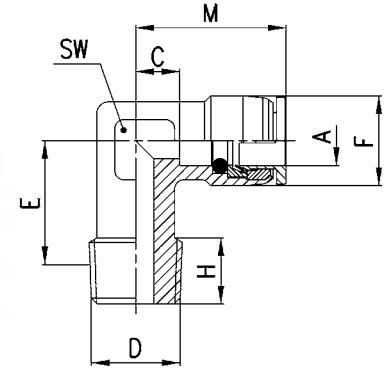

Fittings Model X6520

BSPT Swivel Elbow

DIMENSIONS (in mm)

Model	A	C	D	E	F	H	M	SW	SW1	Weight (g)	Package (pcs)
X6520 4-1/8	4	4.3	R1/8	15.3	10	8	16.8	12	12	20	10
X6520 4-1/4	4	4.3	R1/4	15.8	10	10	16.8	12	15	24	10
X6520 6-1/8	6	8.8	R1/8	15.3	11.9	8	22.3	12	12	24	10
X6520 6-1/4	6	5.8	R1/4	19.8	13	10	19.3	14	15	33	10
X6520 8-1/8	8	9.4	R1/8	19.5	15	8	25.5	14	12	41	10
X6520 8-1/4	8	9.4	R1/4	19.8	15	10	25.5	14	15	44	10
X6520 10-1/4	10	10.7	R1/4	20.6	17.4	10	27.9	17	15	57	10
X6520 10-3/8	10	10.7	R3/8	20.9	17.4	11	27.9	17	19	65	10
X6520 12-1/4	12	9.5	R1/4	21.1	20	10	28.5	17	15	55	10
X6520 12-3/8	12	9.5	R3/8	20.9	20	11	28.5	17	19	65	10
X6520 12-1/2	12	9.5	R1/2	19.4	20	13	28.5	17	22	80	10

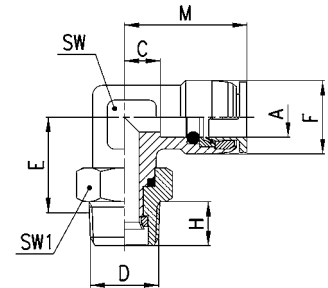

Fittings Model X6522

BSP Swivel Elbow

DIMENSIONS (in mm)

Model	A	C	D	E	F	G	H	M	SW	SW1	Weight (g)	Package
X6522 4-1/8	4	4.3	G1/8	15.3	10	15	6.5	16.8	12	14	22	10
X6522 4-1/4	4	4.3	G1/4	15.7	10	18.5	9	16.8	12	17	25	10
X6522 6-1/8	6	8.8	G1/8	15.3	11.9	15	6.5	22.3	12	14	26	10
X6522 6-1/4	6	5.8	G1/4	18.7	13	18.5	9	19.3	14	17	40	10
X6522 8-1/8	8	9.4	G1/8	19.5	15	15	6.5	25.5	14	14	43	10
X6522 8-1/4	8	9.4	G1/4	18.7	15	18.5	9	25.5	14	17	46	10
X6522 10-1/4	10	10.7	G1/4	19.5	17.4	18.5	9	27.9	17	17	59	10
X6522 10-3/8	10	10.7	G3/8	20.4	17.4	24	9	27.9	17	22	72	10
X6522 12-1/4	12	9.5	G1/4	20	20	18.5	9	28.5	17	17	63	10
X6522 12-3/8	12	9.5	G3/8	20.4	20	24	9	28.5	17	22	73	10
X6522 12-1/2	12	9.5	G1/2	20.4	20	30	9.5	28.5	17	27	83	10

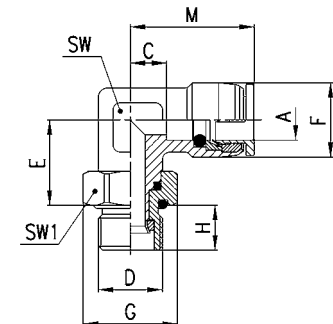

Fittings Model X6550

Elbow Union

DIMENSIONS (in mm)

Model	A	C	F	M	SW	Weight (g)	Package
X6550 4	4	7.8	11	20.3	12	24	10
X6550 6	6	8.8	11.9	22.3	12	23	10
X6550 8	8	8.4	15	24.5	12	28	10
X6550 10	10	8.7	17.4	25.9	14	42	10
X6550 12	12	9.5	20	28.5	17	58	10

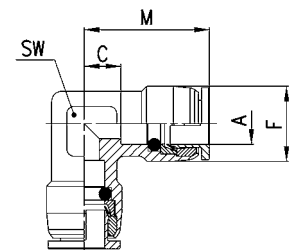

Fittings Model X6432

BSP Swivel Branch Tee

DIMENSIONS (in mm)

Model	A	C	D	E	F	G	H	L	SW	SW1	Weight (g)	Package
X6432 4-1/8	4	4.3	G1/8	15.3	10	15	6.5	33.6	12	14	33	10
X6432 4-1/4	4	4.3	G1/4	15.7	10	18.5	9	33.6	12	17	46	10
X6432 6-1/8	6	8.8	G1/8	16.1	11.9	15	6.5	44.6	12	14	35	10
X6432 6-1/4	6	5.8	G1/4	17.5	13	18.5	9	38.6	14	17	47	10
X6432 8-1/8	8	8.3	G1/8	17.3	15	15	6.5	48.8	14	14	52	10
X6432 8-1/4	8	8.3	G1/4	17.4	15	18.5	9	48.8	14	17	57	10
X6432 10-1/4	10	10.7	G1/4	20	17.4	18.5	9	55.8	17	17	79	10
X6432 10-3/8	10	10.7	G3/8	20.4	17.4	24	9	55.8	17	22	91	10
X6432 12-1/4	12	9.5	G1/4	20	20	18.5	9	57	17	17	82	10
X6432 12-3/8	12	9.5	G3/8	20.4	20	24	9	57	17	22	94	10
X6432 12-1/2	12	9.5	G1/2	20.4	20	30	9.5	57	17	27	115	10

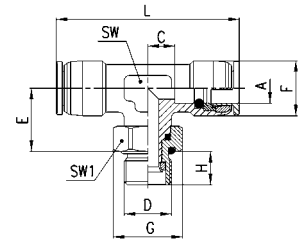

Fittings Model X6430

BSPT Swivel Branch Tee

DIMENSIONS (in mm)

Model	A	C	D	E	F	H	L	SW	SW1	Weight (g)	Package
X6430 4-1/8	4	4.3	R1/8	15.3	10	8	33.6	12	12	33	10
X6430 4-1/4	4	4.3	R1/4	15.8	10	10	33.6	12	15	41	10
X6430 6-1/8	6	8.8	R1/8	16.1	11.9	8	44.6	12	12	33	10
X6430 6-1/4	6	5.8	R1/4	18.6	13	10	38.6	14	15	45	10
X6430 8-1/8	8	8.3	R1/8	17.3	15	8	48.8	14	12	46	10
X6430 8-1/4	8	8.3	R1/4	18.5	15	10	48.8	14	15	54	10
X6430 10-1/4	10	10.7	R1/4	21.1	17.4	10	55.8	17	15	77	10
X6430 10-3/8	10	10.7	R3/8	20.9	17.4	11	55.8	17	19	84	10
X6430 12-1/4	12	9.5	R1/4	21.1	20	10	57	17	15	79	10
X6430 12-3/8	12	9.5	R3/8	20.9	20	11	57	17	19	87	10
X6430 12-1/2	12	15.6	R1/2	19.4	20	13	57	17	22	100	10

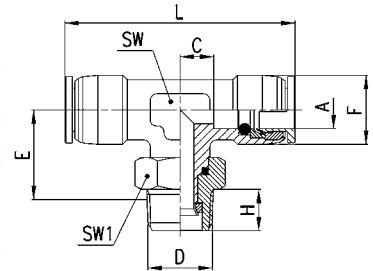

Fittings Model X6540

Tee Union

DIMENSIONS (in mm)

Model	A	C	F	L	M	SW	Weight (g)	Package
X6540 4	4	8.8	11	42.6	21.3	12	32	10
X6540 6	6	8.8	11.9	44.6	22.3	12	33	10
X6540 8	8	8.4	15	49	24.5	12	44	10
X6540 10	10	8.7	17.4	51.8	25.9	14	54	10
X6540 12	12	9.5	20	57	28.5	17	80	10

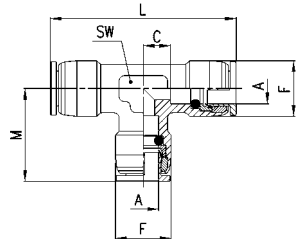

Fittings Model X6800

Plug-in Reducer

DIMENSIONS (in mm)

Model	A	C	F	G	L	T	Weight (g)	Package
X6800 4-6	4	16.8	10	6	29.3	15.3	7	10
X6800 4-8	4	19.8	10	8	32.3	17.8	10	10
X6800 6-8	6	19.8	12	8	33.5	17.8	11	10
X6800 6-10	6	22.6	12	10	36	21.6	12	10
X6800 6-12	6	23	12	12	36.5	-	19	10
X6800 8-10	8	22.5	15	10	38.6	20	14	10
X6800 8-12	8	24.5	15	12	40.6	23	21	10
X6800 10-12	10	26	18	12	43.2	23	27	10

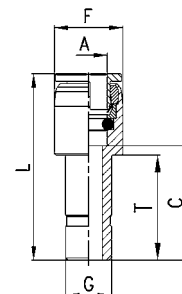

Nickel-Plated Brass Pipe Fittings Series 2000

Thread Type : 10-32 UNF

NPTF (1/8", 1/4", 3/8", 1/2")

Metric (M5)

BSP (G1/8, G1/4, G3/8, G1/2, G3/4, G1)

BSPT (R1/8, R1/4, R3/8, R1/2, R3/4)



When involved in factory maintenance or plant installation it is often difficult to be absolutely certain which size of fittings will be required. Pipe fittings provide a cost effective solution to this problem. The full range includes straight, L-shaped, T-shaped and cross piece male or female couplings and are available in a variety of thread sizes up to 3/4".

The addition of the Camozzi **Sprint®** seal to twelve different models of pipe fittings eliminates the need to use liquid sealants or tape and save a considerable amount of time during installation. The Sprint® fitting can be connected and disconnected several times.

Material: brass OT58 UNI 5705 (nickel-plated).

T. min. - 40°C (-40°F)

T. max. +120°C (250°F)

GENERAL DATA

Material	nickel-plated brass (UNI 5705 OT58) and PTFE
Threads	10-32 UNF, 1/8", 1/4", 3/8", 1/2" NPTF GAS conical ISO 7 (BSPT), typically models ending in "0" and/or with Sprint "S" prefix GAS cylindrical ISO 228 (BSP), typically models ending with "1", (2651/2661 gaskets required are sold separately)
Pressure	40 bar (0 to 580 psi)
Fluid	Compressed air or other low pressure fluids
Temperature	-40°C - 120°C (-40 F to 250 F)

Pipe fittings

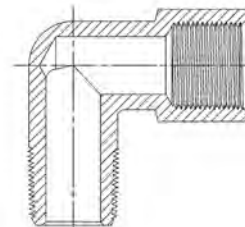

Fittings Model 2500...

Male Hex Nipple

NPTF Threads

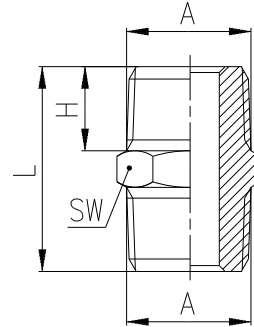

NPTF THREADS

DIMENSIONS (in inches)

Model	A	H	L	SW
NPTF				
2500 02-02	1/8	.315	.807	.472
2500 04-04	1/4	.472	1.142	.551
2500 06-06	3/8	.472	1.142	.748
2500 08-08	1/2	.610	1.437	.866

BSP Threads

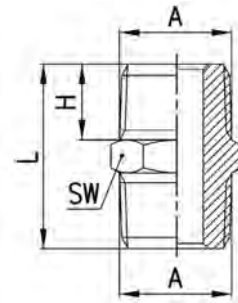

BSP THREADS

DIMENSIONS (in mm)

Model	A	H	L	SW	Weight (g)
2500 1/8	R1/8	7.5	19.5	12	9
2500 1/4	R1/4	11	27	14	16
2500 3/8	R3/8	11.5	28	17	21
2500 1/2	R1/2	14	33.5	22	41
2500 3/4	R3/4	16.5	40	27	80
2500 1	R1	19	45.5	34	125

Fittings Model S2500

BSPT Nipple Sprint®

BSP Threads

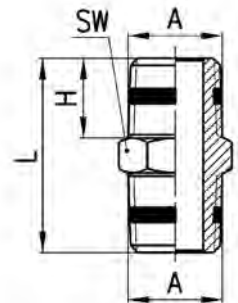

BSP THREADS

DIMENSIONS (in mm)

Model	A	H	L	SW	Weight (g)
S2500 1/8	R1/8	7.5	19.5	12	8
S2500 1/4	R1/4	11	27	14	15
S2500 3/8	R3/8	11.5	28	17	21
S2500 1/2	R1/2	14	33.5	22	39

Fittings Model 2501

Metric-BSP Nipple

BSP THREADS

DIMENSIONS (in mm)

Model	A	H	L	SW	Weight (g)
2501 M5	M5	4	11.5	8	2
2501 1/8	G1/8	6	16.5	13	9
2501 1/4	G1/4	8	21	17	15
2501 3/8	G3/8	9	23	19	21
2501 1/2	G1/2	10	25.5	24	35



BSP Threads

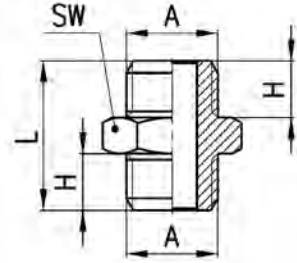

Fittings Model 2510 and S2510...

BSPT Reducing Nipple

BSP THREADS

DIMENSIONS (in mm)

Model	A1	A2	H1	H2	L	SW	Weight (g)
2510 1/8-1/4	R1/8	R1/4	7.5	11	23.5	14	14
2510 1/8-3/8	R1/8	R3/8	7.5	11.5	24	17	18
2510 1/4-3/8	R1/4	R3/8	11	11.5	27.5	17	20
2510 1/4-1/2	R1/4	R1/2	11	14	30.5	22	34
2510 3/8-1/2	R3/8	R1/2	11.5	14	31	22	34
2510 1/2-3/4	R1/2	R3/4	14	16.5	37.5	27	67



BSP Threads

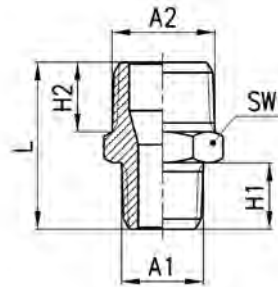

BSP THREADS

DIMENSIONS (in mm)

Model	A1	A2	H1	H2	L	SW	Weight (g)
S2510 1/8-1/4	R1/8	R1/4	7.5	11	23.5	14	14
S2510 1/8-3/8	R1/8	R3/8	7.5	11.5	24	17	22
S2510 1/4-3/8	R1/4	R3/8	11	11.5	27.5	17	19
S2510 1/4-1/2	R1/4	R1/2	11	14	30.5	22	33
S2510 3/8-1/2	R3/8	R1/2	11.5	14	31	22	36

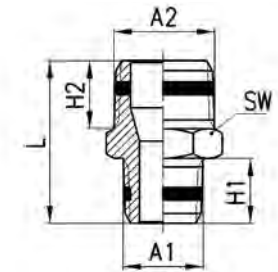

Fittings Model 2511

Metric-BSP Reducing Nipple

BSP THREADS

DIMENSIONS (in mm)

Model	A1	A2	H1	H2	L	SW	Weight (g)
2511 M5-1/8	M5	G1/8	4	6	14.5	13	8
2511 1/8-1/4	G1/8	G1/4	6	8	19	17	15
2511 1/8-3/8	G1/8	G3/8	6	9	20	19	19
2511 1/4-3/8	G1/4	G3/8	8	9	22	19	20
2511 1/4-1/2	G1/4	G1/2	8	10	23.5	24	32
2511 3/8-1/2	G3/8	G1/2	9	10	24.5	24	34



BSP Threads

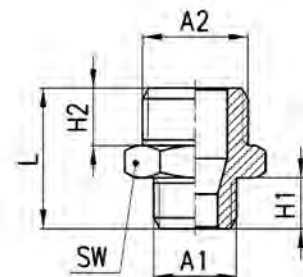

Fittings Model 2520

BSPT Male Reducing Adapter

BSP THREADS

DIMENSIONS (in mm)

Model	A	B	H	L	SW	Weight (g)
2520 1/8-1/8	R1/8	G1/8	7.5	17.5	13	9
2520 1/8-1/4	R1/8	G1/4	7.5	19	17	15
2520 1/8-3/8	R1/8	G3/8	7.5	20	20	19
2520 1/4-1/4	R1/4	G1/4	11	22.5	17	17
2520 1/4-3/8	R1/4	G3/8	11	23.5	20	21
2520 1/4-1/2	R1/4	G1/2	11	27.5	24	35
2520 3/8-3/8	R3/8	G3/8	11.5	24	20	23
2520 3/8-1/2	R3/8	G1/2	11.5	28	24	37
2520 1/2-1/2	R1/2	G1/2	14	30.5	24	41



BSP Threads

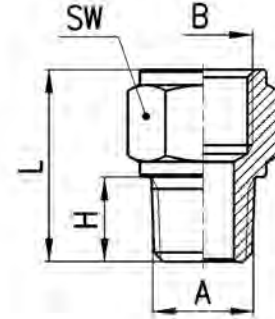

Fittings Model S2520

BSPT Male Reducing Adapter Sprint®

BSP THREADS

DIMENSIONS (in mm)

Model	A	B	H	L	SW	Weight (g)
S2520 1/8-1/8	R1/8	G1/8	7.5	17.5	13	11
S2520 1/8-1/4	R1/8	G1/4	7.5	19	17	15
S2520 1/8-3/8	R1/8	G3/8	7.5	20	20	19
S2520 1/4-1/4	R1/4	G1/4	11	22.5	17	17
S2520 1/4-3/8	R1/4	G3/8	11	23.5	20	33
S2520 1/4-1/2	R1/4	G1/2	11	27.5	24	34
S2520 3/8-3/8	R3/8	G3/8	11.5	24	20	36
S2520 3/8-1/2	R3/8	G1/2	11.5	28	24	56
S2520 1/2-1/2	R1/2	G1/2	14	30.5	24	41



BSP Threads

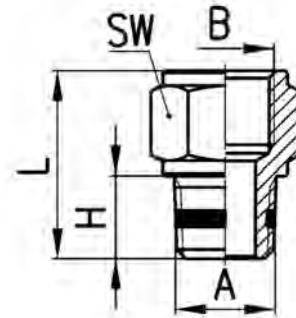

Fittings Model 2520...

Adapter BSPP Female – NPTF Male

BSP THREADS

DIMENSIONS (in inches)

Model	A	B	H	L	SW
	UNF	METRIC			
2520 32-M5	10-32	M5	.177	.472	.315
	NPTF	BSP			
2520 02-1/8	1/8	1/8	.315	.708	.512
2520 04-1/4	1/4	1/4	.472	.925	.669
2520 06-3/8	3/8	3/8	.472	.964	.787
2520 08-1/2	1/2	1/2	.551	1.200	.945



NPTF Threads

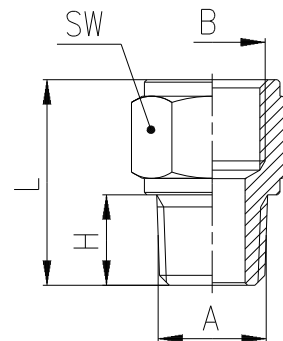

Fittings Model 2521...
Adapter NPTF Female – BSPP Male

NPTF and BSP THREADS

DIMENSIONS (in inches)

Model	A	B	H	L	SW
	BSP	NPTF			
2521 1/8-02	1/8	1/8	.236	.630	.512
2521 1/4-04	1/4	1/4	.315	.846	.669
2521 3/8-06	3/8	3/8	.354	.905	.787
2521 1/2-08	1/2	1/2	.393	1.102	.945



NPTF Threads

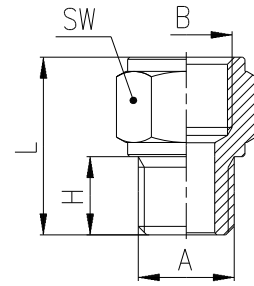

Fittings Model 2521
Metric-BSP Reducing Adapter

BSP THREADS

DIMENSIONS (in mm)

Model	A	B	H	L	SW	Weight (g)
2521 M5-1/8	M5	G1/8	4	14	13	7
2521 1/8-1/8	G1/8	G1/8	6	16	13	8
2521 1/8-1/4	G1/8	G1/4	6	17.5	17	14
2521 1/8-3/8	G1/8	G3/8	6	18.5	20	30
2521 1/4-1/4	G1/4	G1/4	8	19.5	17	16
2521 1/4-3/8	G1/4	G3/8	8	20.5	20	20
2521 1/4-1/2	G1/4	G1/2	8	24.5	24	33
2521 3/8-3/8	G3/8	G3/8	9	21.5	20	22
2521 3/8-1/2	G3/8	G1/2	9	25.5	24	35
2521 1/2-1/2	G1/2	G1/2	10	26.5	24	36



BSP Threads

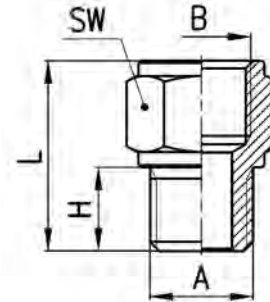

Fittings Model S2530
BSPT Reducing Bushing Sprint®

BSP THREADS

DIMENSIONS (in mm)

Model	A	B	H	L	SW	Weight (g)
S2530 1/4-1/8	R1/4	G1/8	11	16	14	9
S2530 3/8-1/8	R3/8	G1/8	11.5	16.5	17	16
S2530 1/2-1/8	R1/2	G1/8	14	19.5	22	13
S2530 3/8-1/4	R3/8	G1/4	11.5	16.5	17	33
S2530 1/2-1/4	R1/2	G1/4	14	19.5	22	32
S2530 1/2-3/8	R1/2	G3/8	14	19.5	22	22



BSP Threads

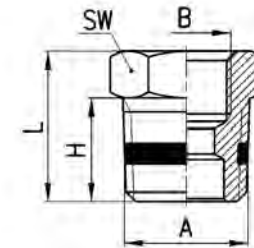

Fittings Model 2530
BSPT Reducing Bushing

BSP THREADS

DIMENSIONS (in mm)

Model	A	B	H	L	P	SW	Weight (g)
2530 1/4-1/8	R1/4	G1/8	11	16	6	14	9
2530 3/8-1/8	R3/8	G1/8	11.5	16.5	8.5	17	17
2530 1/2-1/8	R1/2	G1/8	14	19.5	9.5	22	12
2530 3/8-1/4	R3/8	G1/4	11.5	16.5	7	17	34
2530 1/2-1/4	R1/2	G1/4	14	19.5	9.5	22	30
2530 1/2-3/8	R1/2	G3/8	14	19.5	8	22	24
2530 3/4-3/8	R3/4	G3/8	16.5	23	11.5	27	67
2530 3/4-1/2	R3/4	G1/2	16.5	23.5	9.5	27	48
2530 1-1/2	R1	G1/2	19	27	14	34	131



BSP Threads

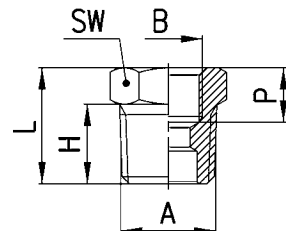

Fittings Model 2530...

Bushing NPTF – NPTF

NPTF and BSP THREADS

DIMENSIONS (in inches)

Model	A	B	H	L	SW
	NPTF	UNF			
2530 02-32	1/8	10-32	.315	.492	.472
	NPTF	NPTF			
2530 04-02	1/4	1/8	.472	.669	.551
2530 06-02	3/8	1/8	.472	.669	.748
2530 06-04	3/8	1/4	.472	.669	.748
2530 08-04	1/2	1/4	.610	.827	.866
2530 08-06	1/2	3/8	.610	.827	.866



NPTF Threads

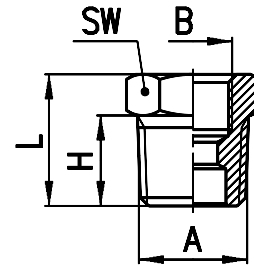

Fittings Model 2531

BSP Reducing Bushing

BSP THREADS

DIMENSIONS (in mm)

Model	A	B	H	L	SW	Weight (g)
2531 1/8-M5	G1/8	M5	6	10.5	13	8 *
2531 1/4-1/8	G1/4	G1/8	8	13	17	11 *
2531 3/8-1/8	G3/8	G1/8	9	14	19	17
2531 3/8-1/4	G3/8	G1/4	9	14	19	12 *
2531 1/2-1/8	G1/2	G1/8	10	15.5	24	32
2531 1/2-1/4	G1/2	G1/4	10	15.5	24	29
2531 1/2-3/8	G1/2	G3/8	10	15.5	24	22 *



BSP Threads

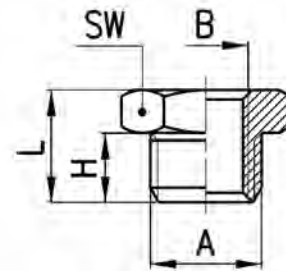

* = with through-out thread

Fittings Model 2541

BSPT Swivel Male Adapter Sprint®

BSP THREADS

DIMENSIONS (in mm)

Model	A	B	H	L	SW	SW1	Weight (g)
2541 1/8-1/8	G1/8	G1/8	5.5	28	13	14	17
2541 1/4-1/4	G1/4	G1/4	7	31.5	17	14	26
2541 3/8-3/8	G3/8	G3/8	8	34	20	19	39



BSP Threads

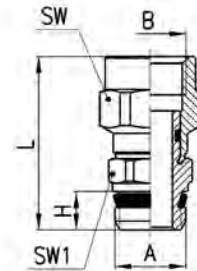

Fittings Model 2525

BSP Male Extension

BSP THREADS

DIMENSIONS (in mm)

Model	A	B	H	I	L	SW	Weight (g)
2525 1/8-16	G1/8	G1/8	6	16	22	13	12
2525 1/8-36	G1/8	G1/8	6	36	42	13	24
2525 1/4-27	G1/4	G1/4	8	27	35	17	30
2525 1/4-43	G1/4	G1/4	8	43	51	17	45



BSP Threads

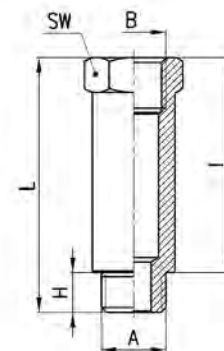

Fittings Model 2553
Reducing Female Coupling

BSP THREADS

DIMENSIONS (in mm)

Model	B1	B2	L	SW	Weight (g)
2553 M5-1/8	M5	G1/8	13.5	13	7
2553 1/8-1/4	G1/8	G1/4	17	17	18
2553 1/8-3/8	G1/8	G3/8	18	20	18
2553 1/8-1/2	G1/8	G1/2	21.5	24	28
2553 1/4-3/8	G1/4	G3/8	19.5	20	21
2553 1/4-1/2	G1/4	G1/2	23	24	32
2553 3/8-1/2	G3/8	G1/2	24	24	31



BSP Threads

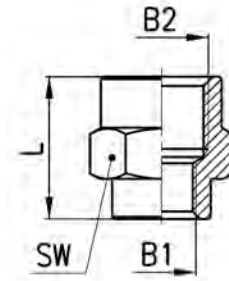

Fittings Model 2543
Female Union Coupling

BSP THREADS

DIMENSIONS (in mm)

Model	B	L	SW	Weight (g)
2543 M5	M5	11	8	3
2543 1/8	G1/8	15	13	8
2543 1/4	G1/4	22	17	19
2543 3/8	G3/8	23	20	19
2543 1/2	G1/2	28	24	29



BSP Threads

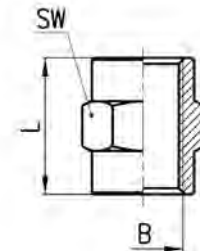

Fittings Model 2543...
Coupling NPTF Female – NPTF Female

DIMENSIONS (in inches)

Model	B	L	SW
NPTF			
2543 02-02	1/8	.630	.512
2543 04-04	1/4	.905	.669
2543 06-06	3/8	.945	.787
2543 08-08	1/2	1.220	.945



NPTF Threads

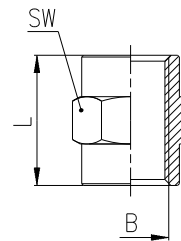

Fittings Model 2601
Metric-BSP Male Hose Adapter

BSP THREADS

DIMENSIONS (in mm)

Model	N	A	C	H	I	L	SW	Weight (g)
2601 2-M5	2	M5	1.2	4	8	16	8	2
2601 4.5-M5	4	M5	2.5	4	15	23	8	3
2601 7-1/8	7	G1/8	4	6	20	30	12	9
2601 7-1/4	7	G1/4	4	8	20	33	17	16
2601 8-1/8	8	G1/8	5	6	20	30	12	10
2601 9-1/8	9	G1/8	5.5	6	20	30	12	11
2601 9-1/4	9	G1/4	6	8	20	33	17	17
2601 9-3/8	9	G3/8	6	9	20	34	19	21
2601 12-1/4	12	G1/4	8.5	8	20	33	17	20
2601 12-3/8	12	G3/8	9	9	20	34	19	23
2601 12-1/2	12	G1/2	9	10	20	35.5	24	34
2601 17-3/8	17	G3/8	12	9	24	38	19	31
2601 17-1/2	17	G1/2	13	10	24	39.5	24	41



BSP Threads

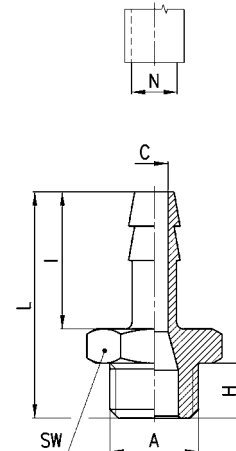

Fittings Model 2611

BSP Male Plug

BSP THREADS					
DIMENSIONS (in mm)					
Model	A	H	L	SW	Weight (g)
2611 M5	M5	4	7.5	8	2
2611 1/8	G1/8	6	10.5	13	7
2611 1/4	G1/4	8	13	17	13
2611 3/8	G3/8	9	14	19	18
2611 1/2	G1/2	10	15.5	24	31
2611 1	G1	13	19	38	76



BSP Threads

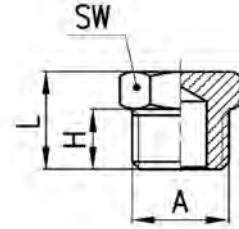

Fitting Model 2610 3/4

BSPT Male Plug

BSP THREADS					
DIMENSIONS (in mm)					
Model	A	H	L	SW	Weight (g)
2610 3/4	R3/4	16.5	23	27	61



BSP Threads

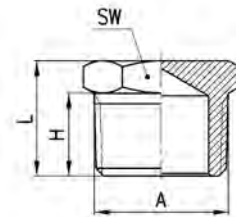

Fittings Model 2613

BSP Female Cap Plug

BSP THREADS				
DIMENSIONS (in mm)				
Model	B	L	SW	Weight (g)
2613 1/8	G1/8	11	12	6
2613 1/4	G1/4	13.5	15	13
2613 3/8	G3/8	15.5	18	19
2613 1/2	G1/2	22.5	19	33



BSP Threads

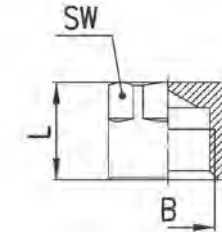

Fittings Model S2615

BSPT Male Hex Plug Sprint®

BSP THREADS				
DIMENSIONS (in mm)				
Model	A	L	SW	Weight (g)
S2615 1/8	R1/8	8	5	2
S2615 1/4	R1/4	10	7	6
S2615 3/8	R3/8	10	8	12



BSP Threads

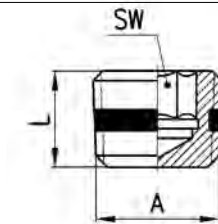

Fittings Model 2612 M7 and Model S2610

Model 2612 M7: Metric Male Socket-Cap Plug
Model S2610: BSP Male Socket-Cap Plug Sprint®

BSP THREADS				
DIMENSIONS (in mm)				
Model	A	L	SW	Weight (g)
2612 M5	M5	5.5	2	1 *
2612 M7	M7	7	4	2 *
S2610 1/8	G1/8	7.5	4	3
S2610 1/4	G1/4	9	6	6
S2610 3/8	G3/8	10	8	12
S2610 1/2	G1/2	11	10	21



* with O-ring

BSP Threads

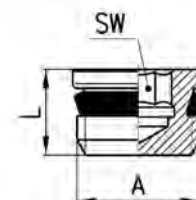

Fittings Model 2020 and 2021...

Elbow NPTF Female – NPTF Male
Model 2021: Metric Male Female Elbow
Model 2020: BSPT Male Female Elbow

DIMENSIONS (in inches)

Model	A	B	E	H	M	SW
	NPTF	NPTF				
2020 02-00	1/8	1/8	.551	.335	.748	.472
2020 04-00	1/4	1/4	.630	.453	.984	.551
2020 06-00	3/8	3/8	.571	.433	1.043	.630
2020 08-00	1/2	1/2	.768	.591	1.299	.787

BSP THREADS

DIMENSIONS (in mm)

Model	A	B	E	H	M	P	SW	Weight (g)
2021 M5-M5	M5	M5	9	4	10.5	4.5	9	7
2020 1/8-1/8	R1/8	G1/8	11.5	8.5	19	6	11	17
2020 1/4-1/4	R1/4	G1/4	15	11	23	7	13	27
2020 3/8-3/8	R3/8	G3/8	15	11.5	25	8	15	33
2020 1/2-1/2	R1/2	G1/2	17.5	14	31.5	9.5	20	63
2020 3/4-3/4	R3/4	G3/4	19	16	36.5	16.5	25	126
2020 1-1	R1	G1	23	17	45	19	30	209

NPTF Threads

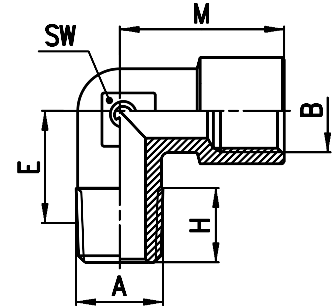

BSP Threads

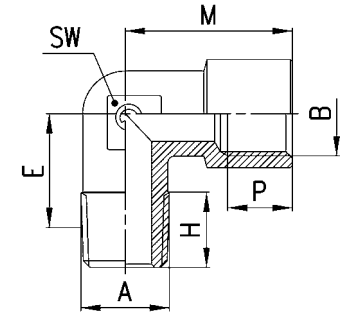

Fittings Model S2020

Male Female Elbow Sprint®

BSP THREADS

DIMENSIONS (in mm)

Model	A	B	E	H	M	SW	Weight (g)
S2020 1/8-1/8	R1/8	G1/8	11.5	8.5	19	11	16
S2020 1/4-1/4	R1/4	G1/4	15	11	23	13	27
S2020 3/8-3/8	R3/8	G3/8	15	11.5	25	15	33
S2020 1/2-1/2	R1/2	G1/2	17.5	14	31.5	20	62

BSP Threads

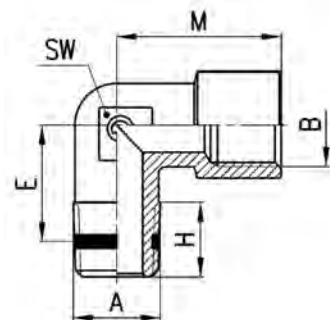

Fittings Model 2010
BSP Male Elbow

BSP THREADS

DIMENSIONS (in mm)

Model	A	E	H	SW	Weight (g)
2010 1/8	R1/8	11.5	7.5	9	10
2010 1/4	R1/4	13.5	11	12	18
2010 3/8	R3/8	15.5	11.5	14	28
2010 1/2	R1/2	16	14	16	47
2010 3/4	R3/4	19	16	25	103
2010 1	R1	23	17	30	183



BSP Threads

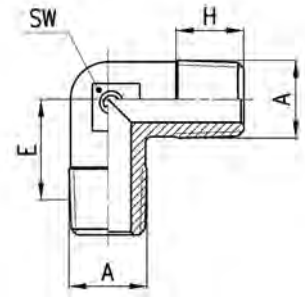

Fittings Model S2010
BSPT Male Elbow Sprint®

BSP THREADS

DIMENSIONS (in mm)

Model	A	E	H	SW	Weight (g)
S2010 1/8	R1/8	11.5	7.5	9	9
S2010 1/4	R1/4	13.5	11	12	17
S2010 3/8	R3/8	15.5	11.5	14	25
S2010 1/2	R1/2	16	14	16	47



BSP Threads

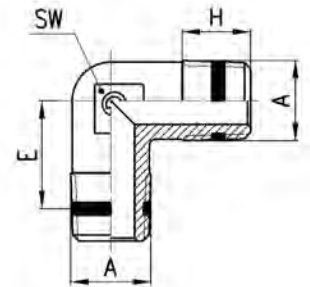

Fittings Model 2013...
Elbow NPTF Female – NPTF Female

DIMENSIONS (in inches)

Model	B	M	SW
NPTF			
2013 02-00	1/8	.748	.472
2013 04-00	1/4	.094	.551
2013 06-00	3/8	1.043	.630
2013 08-00	1/2	1.299	.787



NPTF Threads

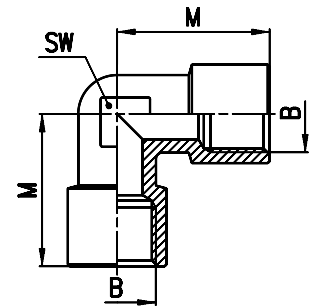

Fittings Model 2013
BSPP Female Elbow

BSP THREADS

DIMENSIONS (in mm)

Model	B	M	SW	Weight (g)
2013 1/8	G1/8	19	11	16
2013 1/4	G1/4	23	14	28
2013 3/8	G3/8	25	16	39
2013 1/2	G1/2	31.5	20	69



BSP Threads

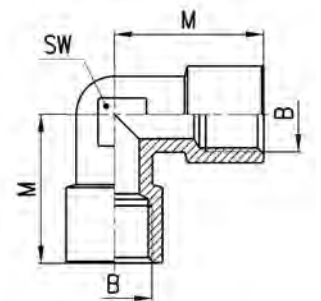

Fittings Model 2080

Male Tee

BSP THREADS

DIMENSIONS (in mm)

Model	A	E	H	SW	Weight (g)
2080 1/8	R1/8	11.5	7.5	9	14
2080 1/4	R1/4	13.5	11	12	25
2080 3/8	R3/8	15.5	11.5	14	39
2080 1/2	R1/2	16	14	16	82
2080 3/4	R3/4	19	16.2	25	135
2080 1	R1	23	17.5	30	239



BSP Threads

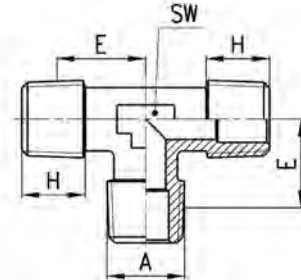

Fittings Model S2080

Male Tee Sprint®

BSP THREADS

DIMENSIONS (in mm)

Model	A	E	H	SW	Weight (g)
S2080 1/8	R1/8	11.5	7.5	9	14
S2080 1/4	R1/4	13.5	11	12	31
S2080 3/8	R3/8	15.5	11.5	14	50
S2080 1/2	R1/2	16	14	16	63



BSP Threads

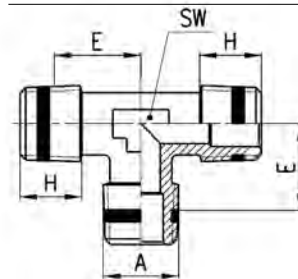

Fittings Model 2090

M.F.M. Tee

BSP THREADS

DIMENSIONS (in mm)

Model	A	B	E	H	M	P	SW	Weight (g)
2090 1/8-1/8	R1/8	G1/8	11.5	8.5	19	6	12	22
2090 1/4-1/4	R1/4	G1/4	15	11	23	7	13	37
2090 3/8-3/8	R3/8	G3/8	15	11.5	25	8	16	44
2090 1/2-1/2	R1/2	G1/2	17.5	14	31.5	9.5	20	83
2090 3/4-3/4	R3/4	G3/4	19	16	36.5	16.5	25	156
2090 1-1	R1	G1	23	17.5	45	19	30	262



BSP Threads

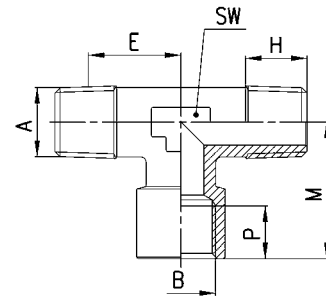

Fittings Model S2090

M.F.M. Tee Sprint®

BSP THREADS

DIMENSIONS (in mm)

Model	A	B	E	H	M	SW	Weight (g)
S2090 1/8-1/8	R1/8	G1/8	11.5	8.5	19	12	22
S2090 1/4-1/4	R1/4	G1/4	15	11	23	13	16
S2090 3/8-3/8	R3/8	G3/8	15	11.5	25	16	59
S2090 1/2-1/2	R1/2	G1/2	17.5	14	31.5	20	80



BSP Threads

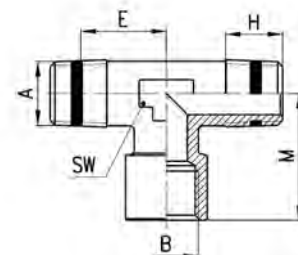

Fittings Model 2060

F.M.F. Tee

BSP Threads

BSP THREADS							
DIMENSIONS (in mm)							
Model	A	B	E	H	M	SW	Weight (g)
2060 1/8-1/8	R1/8	G1/8	11.5	8.5	19	12	22
2060 1/4-1/4	R1/4	G1/4	15	11	23	13	38
2060 3/8-3/8	R3/8	G3/8	15	11.5	25	16	49
2060 1/2-1/2	R1/2	G1/2	17.5	14	31.5	20	89

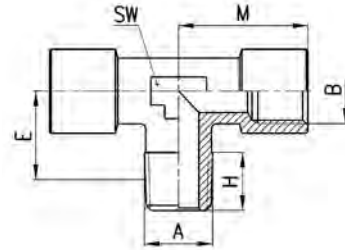

Fittings Model S2060

F.M.F. Tee Sprint®

BSP Threads

BSP THREADS							
DIMENSIONS (in mm)							
Model	A	B	E	H	M	SW	Weight (g)
S2060 1/8-1/8	R1/8	G1/8	11.5	8.5	19	12	31
S2060 1/4-1/4	R1/4	G1/4	15	11	23	13	38
S2060 3/8-3/8	R3/8	G3/8	15	11.5	25	16	51
S2060 1/2-1/2	R1/2	G1/2	17.5	14	31.5	20	88

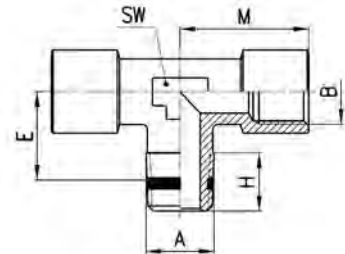

Fittings Model 2070

M.F.F. Tee

BSP Threads

BSP THREADS								
DIMENSIONS (in mm)								
Model	A	B	E	H	L	M	SW	Weight (g)
2070 1/8-1/8	R1/8	G1/8	11.5	8.5	37	19	12	22
2070 1/4-1/4	R1/4	G1/4	15	11	46	23	13	37
2070 3/8-3/8	R3/8	G3/8	15	11.5	48.5	25	16	49
2070 1/2-1/2	R1/2	G1/2	17.5	14	60.5	31.5	20	89

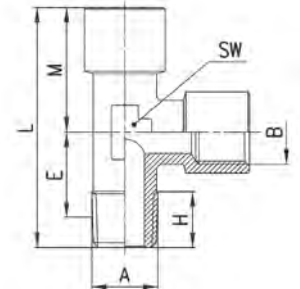

Fittings Model S2070

M.F.F. Tee Sprint®

BSP Threads

BSP THREADS								
DIMENSIONS (in mm)								
Model	A	B	E	H	L	M	SW	Weight (g)
S2070 1/8-1/8	R1/8	G1/8	11.5	8.5	37	19	12	30
S2070 1/4-1/4	R1/4	G1/4	15	11	46	23	13	36
S2070 3/8-3/8	R3/8	G3/8	15	11.5	48.5	25	16	51
S2070 1/2-1/2	R1/2	G1/2	17.5	14	60.5	31.5	20	89

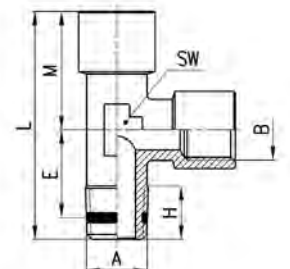

Fittings Model 2003...

Female Tee NPTF

DIMENSIONS (in inches)			
Model	B	M	SW
NPTF			
2003 02-00	1/8	.748	.472
2003 04-00	1/4	.984	.551
2003 06-00	3/8	1.043	.630
2003 08-00	1/2	1.299	.787



NPTF Threads

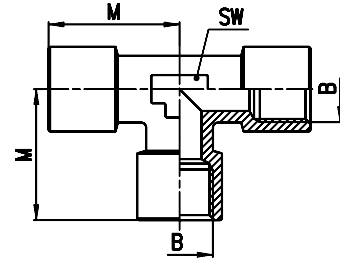

BSP THREADS				
DIMENSIONS (in mm)				
Model	B	M	SW	Weight (g)
2003 1/8	G1/8	19	12	23
2003 1/4	G1/4	23	13	39
2003 3/8	G3/8	25	16	54
2003 1/2	G1/2	31.5	20	97



BSP Threads

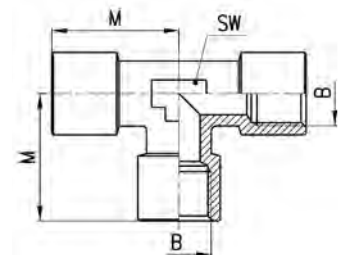

Fittings Model 2050

M.M.F. Tee

BSP THREADS								
DIMENSIONS (in mm)								
Model	A	B	E	H	L	M	SW	Weight (g)
2050 1/8-1/8	R1/8	G1/8	11.5	8.5	37	19	12	27
2050 1/4-1/4	R1/4	G1/4	15	11	46	23	13	35
2050 3/8-3/8	R3/8	G3/8	15	11.5	48.5	25	16	44
2050 1/2-1/2	R1/2	G1/2	17.5	14	60.5	31.5	20	83



BSP Threads

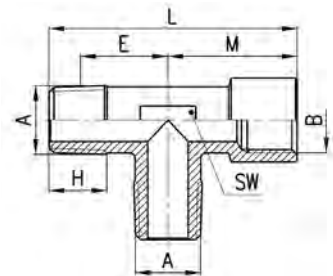

Fittings Model S2050

M.M.F. Tee Sprint®

BSP THREADS								
DIMENSIONS (in mm)								
Model	A	B	E	H	L	M	SW	Weight (g)
S2050 1/8-1/8	R1/8	G1/8	11.5	8.5	37	19	12	14
S2050 1/4-1/4	R1/4	G1/4	15	11	46	23	13	44
S2050 3/8-3/8	R3/8	G3/8	15	11.5	48.5	25	16	59
S2050 1/2-1/2	R1/2	G1/2	17.5	14	60.5	31.5	20	81



BSP Threads

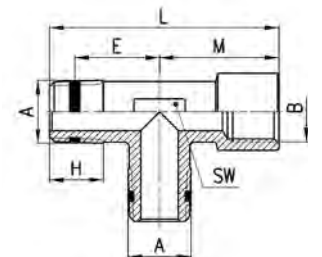

Fittings Model 2033...

Female Cross

NPTF THREADS

DIMENSIONS (in inches)

MOD	B	M	SW
UNF			
2033 32-00	10-32	.374	.354
NPTF			
2033 02-00	1/8	.748	.472
2033 04-00	1/4	.984	.551
2033 06-00	3/8	1.043	.629

BSP THREADS

DIMENSIONS (in mm)

Model	B	M	SW	Weight (g)
2033 1/8	G1/8	19	12	27
2033 1/4	G1/4	23	14	51
2033 3/8	G3/8	25	16	70

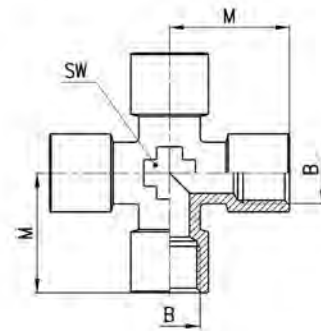
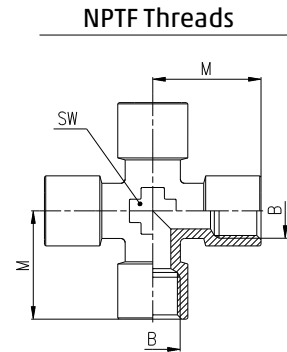

Fittings Model 2040

Y F.M.F.

BSP THREADS

DIMENSIONS (in mm)

Model	A	B	E	F	H	L	M	P	SW	Weight (g)
2040 1/8-1/8	R1/8	G1/8	9.5	14.5	8	32	14	8	13	22
2040 1/4-1/4	R1/4	G1/4	12	18	11	38	17.5	11	17	38
2040 3/8-3/8	R3/8	G3/8	13.5	20.5	11.5	42.5	19	11.5	20	52
2040 1/2-1/2	R1/2	G1/2	15.5	26.5	14	53	24.5	14	25	110

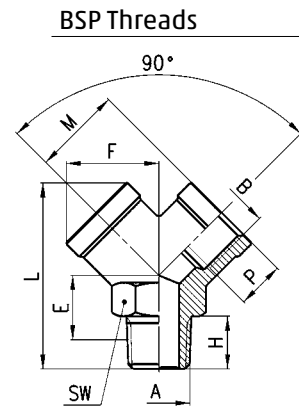

Fittings Model 2043

Female Y

BSP THREADS

DIMENSIONS (in mm)

Model	B	F	L	M	M1	P	SW	Weight (g)
2043 1/8	G1/8	14.5	26.5	14	12	8	13	18
2043 1/4	G1/4	18	32	17.5	14	11	17	32
2043 3/8	G3/8	20.5	37	19	16	11.5	20	44
2043 1/2	G1/2	26.5	45	24.5	19	14	25	84

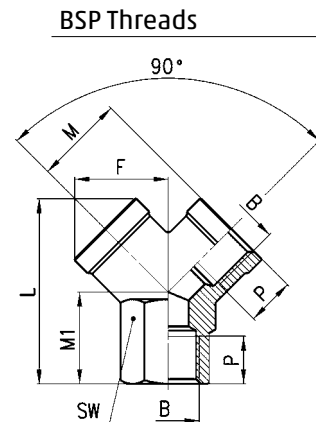

Fittings Model 3033...

4 Ways Distribution Block with mounting holes
Material: Anodized Aluminium

NPTF Threads

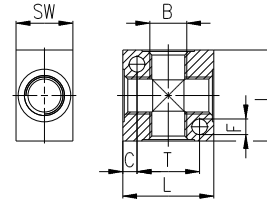

NPTF THREADS						
DIMENSIONS (in inches)						
Model	B	C	F	L	T	SW
NPTF						
3033 02-00	1/8	.157	.177	.984	.669	.630
3033 04-00	1/4	.196	.216	1.260	.866	.787
3033 06-00	3/8	.275	.216	1.575	1.023	.984
3033 08-00	1/2	.315	.216	1.968	1.338	1.181

BSP Threads

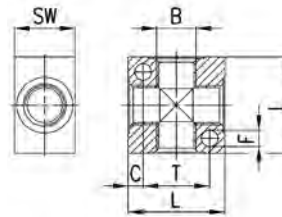

BSP THREADS							
DIMENSIONS (in mm)							
Model	B	C	F	L	T	SW	Weight (g)
3033 1/8	G1/8	4	4.5	25	17	16	18
3033 1/4	G1/4	5	5.5	32	22	20	35
3033 3/8	G3/8	7	5.5	40	26	25	73
3033 1/2	G1/2	8	5.5	50	34	30	137

Accessories Model 3043

Manifold with double lateral outlets
Material: Anodized Aluminium

BSP Threads

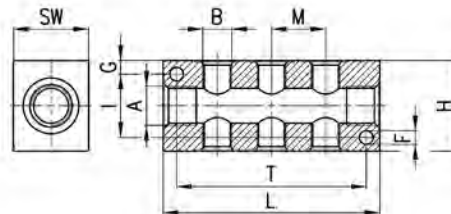

BSP THREADS												
DIMENSIONS (in mm)												
Model	A	DOUBLE LATERAL OUTLETS	B	F	G	H	I	L	M	T	SW	Weight (g)
3043 1/4-3D-1/8	1/4	3	1/8	4.5	4.5	30	21	72	18	63	20	85
3043 1/4-4D-1/8	1/4	4	1/8	4.5	4.5	30	21	90	18	81	20	107
3043 1/4-5D-1/8	1/4	5	1/8	4.5	4.5	30	21	108	18	99	20	128
3043 1/4-6D-1/8	1/4	6	1/8	4.5	4.5	30	21	126	18	117	20	151
3043 3/8-3D-1/4	3/8	3	1/4	5.5	6	40	28	92	24	75	25	177
3043 3/8-4D-1/4	3/8	4	1/4	5.5	6	40	28	116	24	99	25	224
3043 3/8-5D-1/4	3/8	5	1/4	5.5	6	40	28	140	24	123	25	270
3043 3/8-6D-1/4	3/8	6	1/4	5.5	6	40	28	164	24	147	25	315
3043 1/2-3D-3/8	1/2	3	3/8	5.5	6.5	50	37	104	26	85	30	287
3043 1/2-4D-3/8	1/2	4	3/8	5.5	6.5	50	37	130	26	111	30	356
3043 1/2-5D-3/8	1/2	5	3/8	5.5	6.5	50	37	156	26	137	30	427
3043 1/2-6D-3/8	1/2	6	3/8	5.5	6.5	50	37	182	26	163	30	495

Accessories Model 3053

Manifold with lateral outlets
Material: Anodized Aluminium

BSP THREADS

DIMENSIONS (in mm)

Model	A	SINGLE LATERAL OUTLETS	B	F	G	H	L	M	T	SW	Weight (g)
3053 1/4-3L-1/8	1/4	3	1/8	4.5	4.5	30	72	18	63	20	92
3053 1/4-4L-1/8	1/4	4	1/8	4.5	4.5	30	90	18	81	20	116
3053 1/4-5L-1/8	1/4	5	1/8	4.5	4.5	30	108	18	99	20	140
3053 1/4-6L-1/8	1/4	6	1/8	4.5	4.5	30	126	18	117	20	164
3053 3/8-3L-1/4	3/8	3	1/4	5.5	6	40	92	24	75	25	191
3053 3/8-4L-1/4	3/8	4	1/4	5.5	6	40	116	24	99	25	243
3053 3/8-5L-1/4	3/8	5	1/4	5.5	6	40	140	24	123	25	294
3053 3/8-6L-1/4	3/8	6	1/4	5.5	6	40	164	24	147	25	345
3053 1/2-3L-3/8	1/2	3	3/8	5.5	6.5	50	104	26	85	30	313
3053 1/2-4L-3/8	1/2	4	3/8	5.5	6.5	50	130	26	111	30	395
3053 1/2-5L-3/8	1/2	5	3/8	5.5	6.5	50	156	26	137	30	474
3053 1/2-6L-3/8	1/2	6	3/8	5.5	6.5	50	182	26	163	30	551

BSP Threads

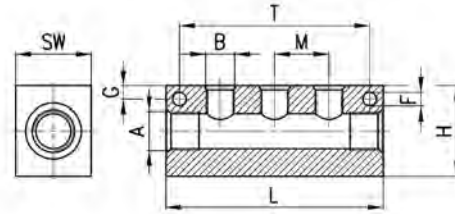

Fittings Model 2023 assembled with Model 1631, 1635

Single Female Banjo

DIMENSIONS (in inches)

Model	B	V	O	M	W
UNF					
2023 32-32	10-32	10-32	.354	.413	.346
NPTF					
2023 02-02	1/8	1/8	.571	.787	.551
2023 04-04	1/4	1/4	.571	1.004	.709
2023 06-06	3/8	3/8	.571	1.102	.827

NPTF Threads

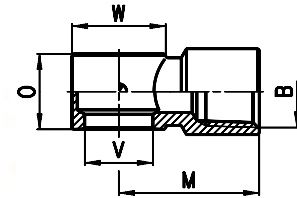

BSP THREADS

DIMENSIONS (in mm)

Model	B	M	O	V	W	Weight (g)
2023 M5-M5	M5	10.5	9	5.1	9	6
2023 M5-M6	M5	10.5	9	5.1	9	6
2023 1/8-1/8	G1/8	20	14.5	9.8	∅ 14	14
2023 1/4-1/4	G1/4	23.5	14.5	13.2	∅ 18	21
2023 3/8-3/8	G3/8	26.5	14.5	16.7	∅ 21	27

BSP Threads

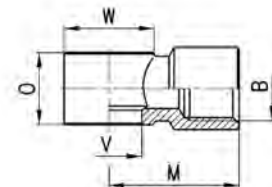

= assembly with Model SCU, SCU,
SVU... M5
= assembly with Model 1635

3

Series 1000 2-Piece Compression Fittings for plastic tubes

Tube external diameters: 5/3, 6/4, 8/6, 10/8, 12/10, 15/12.5 mm
 Fittings threads: metric (M5, M6, M12x1, M12x1.25),
 BSP (G1/8, G1/4, G3/8, G1/2), BSPT (R1/8, R1/4, R3/8, R1/2)

COMPRESSION FITTINGS



Series 1000 rapid push-in fittings can be easily installed.
 The push-in locking nuts can be tightened both manually and with a spanner even in case of stiff tubes like the PA or the Hytrel Polyester.
 The special shape of the guiding cone ensures that the tube cannot be accidentally cut.

GENERAL DATA

Materials	body and nut: nickel-plated brass O-ring: NBR thread seals: PTFE, PA, AL
Threads	GAS conical ISO 7 (BSPT) GAS cylindrical ISO 228 (BSP) M5 - M6 NPT and metric (available on request)
Pressure	the nominal pressure of the fittings is always higher than the pressure of the tube
Tube to connect	PA polyethylene braided PVC rilsan PU, Hytrel Polyester
Diameters	5/3 - 6/4 - 8/6 - 10/8 - 12/10 - 15/12.5 mm
Fluid	compressed air low pressure fluids
Temperature	-20°C ÷ 80°C NOTE: for a better use of the fitting we recommend to check the tubing specifications.

Fitting with connecting tube

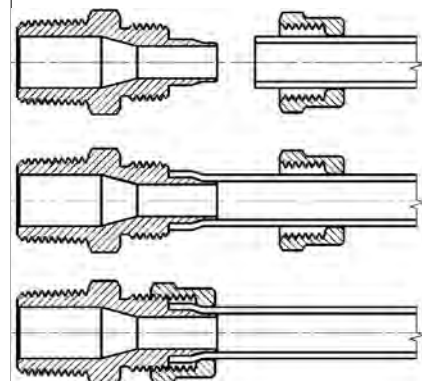

Fittings Mod. 1510

Metric-BSPT Male Connector

DIMENSIONS										
Mod.	Tube	A	C1	H	I	L	R	SW	SW1	Weight (g)
1510 5/3-1/8	5/3	R1/8	2	7.5	12.5	24.5	14.5	12	8	10
1510 6/4-1/8	6/4	R1/8	3	7.5	15	27	16	12	12	15
1510 6/4-1/4	6/4	R1/4	3	11	15	31	18.5	14	12	19
1510 6/4-3/8	6/4	R3/8	3	11.5	15	31.5	18.5	17	12	22
1510 6/4-1/2	6/4	R1/2	3	14	15	34.5	20	22	12	38
1510 6/4-M12x1.25	6/4	M12X1.25	3	10	15	30	18	13	12	17
1510 8/6-1/8	8/6	R1/8	5	7.5	15	27	16	13	14	19
1510 8/6-1/4	8/6	R1/4	5	11	15	31	18.5	14	14	20
1510 8/6-3/8	8/6	R3/8	5	11.5	15	31.5	18.5	17	14	25
1510 8/6-1/2	8/6	R1/2	5	14	15	34.5	20	22	14	39
1510 10/8-1/8	10/8	R1/8	6.5	7.5	16.5	28.5	16.5	14	16	24
1510 10/8-1/4	10/8	R1/4	6.5	11	16.5	32.5	19	14	16	24
1510 10/8-3/8	10/8	R3/8	6.5	11.5	16.5	33	19	17	16	27
1510 10/8-1/2	10/8	R1/2	6.5	14	16.5	36	20.5	22	16	42
1510 12/10-3/8	12/10	R3/8	8.5	11.5	18	34.5	19	17	19	35
1510 12/10-1/2	12/10	R1/2	8.5	14	18	37.5	20.5	22	19	49
1510 15/12.5-1/2	15/12.5	R1/2	11	14	20	39.5	21	22	22	55

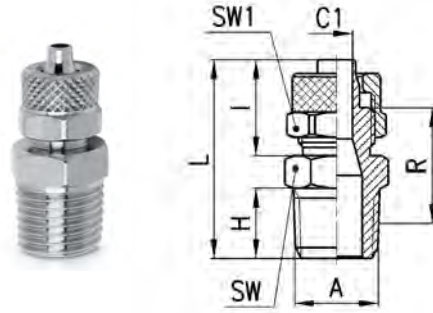

Fittings Mod. 1511

Metric Male Connector Sprint®

DIMENSIONS										
Mod.	Tube	A	C1	H	I	L	R	SW	SW1	Weight (g)
1511 5/3-M5	5/3	M5	2	4	12.5	21	10.5	8	8	5
1511 5/3-M6	5/3	M6	2	4	12.5	21	10.5	9	8	5
1511 5/3-1/8	5/3	G1/8	2	5.5	12.5	23.8	11.8	12	8	10
1511 6/4-M5	6/4	M5	3	4	13.5	22	10.5	8	9	6
1511 6/4-M6	6/4	M6	3	4	13.5	22	10.5	9	9	7
1511 6/4-1/8	6/4	G1/8	3	5.5	15	26.3	13.3	12	12	15
1511 6/4-1/4	6/4	G1/4	3	7	15	28	13.5	14	12	16
1511 6/4-3/8	6/4	G3/8	3	8	15	29.3	13.8	19	12	27
1511 8/6-1/8	8/6	G1/8	5	5.5	15	26.3	13.3	12	14	17
1511 8/6-1/4	8/6	G1/4	5	7	15	28	13.5	14	14	18
1511 8/6-3/8	8/6	G3/8	5	8	15	29.3	13.8	19	14	27
1511 10/8-1/8	10/8	G1/8	6.5	5.5	16.5	27.8	13.8	14	16	23
1511 10/8-1/4	10/8	G1/4	6.5	7	16.5	29.5	14	14	16	25
1511 10/8-3/8	10/8	G3/8	6.5	8	16.5	30.8	14.3	19	16	30
1511 10/8-1/2	10/8	G1/2	6.5	9	16.5	32.5	15	22	16	36
1511 12/10-3/8	12/10	G3/8	8.5	8	18	32.3	14.3	19	19	39
1511 12/10-1/2	12/10	G1/2	8.5	9	18	34	15	22	19	42
1511 15/12.5-1/2	15/12.5	G1/2	11	9	20	36	15.5	22	22	52

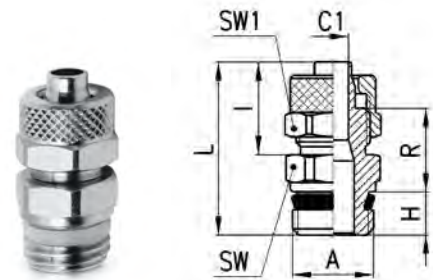

Fittings Mod. 1560

Swivel Male Connector Sprint®

DIMENSIONS											
Mod.	Tube	A	C1	H	I	L	R	SW	SW1	SW2	Weight (g)
1560 6/4-1/8	6/4	G1/8	3	5.5	15	31	18	12	12	12	19
1560 6/4-1/4	6/4	G1/4	3	7	15	32.5	18	12	12	14	25
1560 8/6-1/8	8/6	G1/8	5	5.5	15	32	19	13	14	12	21
1560 8/6-1/4	8/6	G1/4	5	7	15	33.5	19	13	14	14	26
1560 10/8-1/4	10/8	G1/4	6.5	7	16.5	34.5	19	14	16	14	27
1560 10/8-3/8	10/8	G3/8	6.5	8	16.5	36	19.5	14	16	19	38
1560 12/10-3/8	12/10	G3/8	6.5	8	18	38	20	17	19	19	46

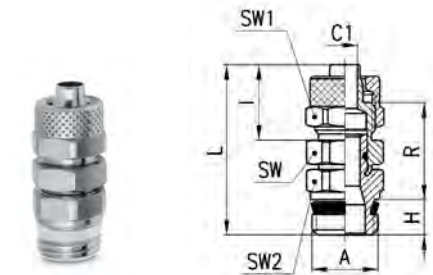

Fittings Mod. 1463

BSP Female Connector

DIMENSIONS									
Mod.	Tube	B	C1	I	L	R	SW	SW1	Weight (g)
1463 5/3-1/8	5/3	G1/8	2	12.5	22.5	16	13	8	10
1463 6/4-1/8	6/4	G1/8	3	15	25	17.5	13	12	14
1463 6/4-1/4	6/4	G1/4	3	15	26.5	19	17	12	21
1463 6/4-3/8	6/4	G3/8	3	15	27.5	20	20	12	25
1463 8/6-1/8	8/6	G1/8	5	15	25	17.5	13	14	16
1463 8/6-1/4	8/6	G1/4	5	15	26.5	19	17	14	22
1463 8/6-3/8	8/6	G3/8	5	15	27.5	20	20	14	26
1463 10/8-1/8	10/8	G1/8	6.5	16.5	21.5	13	14	16	19
1463 10/8-1/4	10/8	G1/4	6.5	16.5	28	19.5	17	16	28
1463 10/8-3/8	10/8	G3/8	6.5	16.5	29	20.5	20	16	31
1463 10/8-1/2	10/8	G1/2	6.5	16.5	33	24.5	24	16	43
1463 12/10-3/8	12/10	G3/8	8.5	18	30.5	20.5	20	19	37

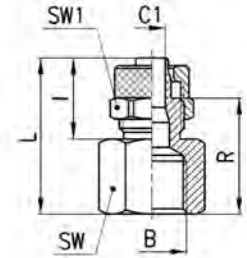

Fittings Mod. 1541

Swivel Male Elbow Sprint®

DIMENSIONS											
Mod.	Tube	A	C1	E	H	M	R	SW	SW1	SW2	Weight (g)
1541 6/4-1/8	6/4	G1/8	3	15	5.5	22.5	15	12	10	12	22
1541 6/4-1/4	6/4	G1/4	3	15	7	22.5	15	12	10	14	27
1541 8/6-1/8	8/6	G1/8	5	15	5.5	22.5	15	14	10	12	23
1541 8/6-1/4	8/6	G1/4	5	15	7	22.5	15	14	10	14	28
1541 10/8-1/4	10/8	G1/4	6.5	16	7	25.5	17	16	12	14	35

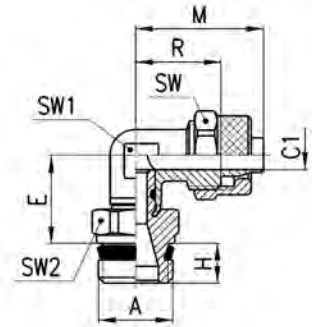

Fittings Mod. 1500

Fix Metric-BSPT Male Elbow

DIMENSIONS										
Mod.	Tube	A	C1	E	H	M	R	SW	SW1	Weight (g)
1500 5/3-1/8	5/3	R1/8	2	13	7.5	21.5	15	8	8	11
1500 6/4-1/8	6/4	R1/8	3	13	7.5	22.5	15	8	12	15
1500 6/4-1/4	6/4	R1/4	3	15.5	11	22.5	15	10	12	21
1500 6/4-3/8	6/4	R3/8	3	17	11.5	23.5	16	12	12	27
1500 6/4-M12x1.25	6/4	M12x1.25	3	14	10	22.5	15	10	12	18
1500 8/6-1/8	8/6	R1/8	5	13	7.5	22.5	15	10	14	19
1500 8/6-1/4	8/6	R1/4	5	15.5	11	22.5	15	10	14	21
1500 8/6-3/8	8/6	R3/8	5	17	11.5	24	16	12	14	29
1500 8/6-1/2	8/6	R1/2	5	21.5	14	27	19	16	14	48
1500 10/8-1/8	10/8	R1/8	6.5	15	7.5	25.5	17	12	16	29
1500 10/8-1/4	10/8	R1/4	6.5	17	11	25.5	17	12	16	29
1500 10/8-3/8	10/8	R3/8	6.5	16.5	11.5	25.5	17	12	16	33
1500 10/8-1/2	10/8	R1/2	6.5	21	14	28.5	20	16	16	58
1500 12/10-3/8	12/10	R3/8	8.5	19	11.5	30	20	14	19	44
1500 12/10-1/2	12/10	R1/2	8.5	21	14	30.5	20.5	16	19	59
1500 15/12.5-1/2	15/12.5	R1/2	11	21	14	34	22.5	16	22	67

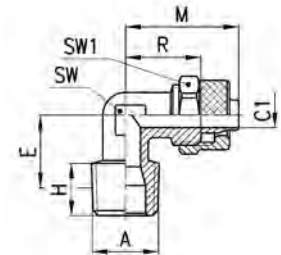

Fittings Mod. 1501 5/3-M5

Metric Fix Male Elbow

DIMENSIONS										
Mod.	Tube	A	C1	E	H	M	R	SW	SW1	Weight (g)
1501 5/3-M5	5/3	M5	2	11	4	21.5	15	8	8	10

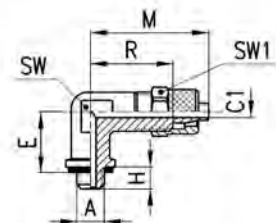

Fittings Mod. 1493

BSP Female Elbow

DIMENSIONS

Mod.	Tube	B	C1	E	M	R	SW	SW1	Weight (g)
1493 6/4-1/8	6/4	G1/8	3	19	22.5	15	10	12	20
1493 6/4-1/4	6/4	G1/4	3	23.5	26	18.5	14	12	34
1493 8/6-1/8	8/6	G1/8	5	19	22.5	15	10	14	21
1493 8/6-1/4	8/6	G1/4	5	23.5	26	19	14	14	34
1493 10/8-1/4	10/8	G1/4	6.5	23.5	27.5	18	14	16	39
1493 12/10-3/8	12/10	G3/8	8.5	26	30.5	20.5	16	19	53

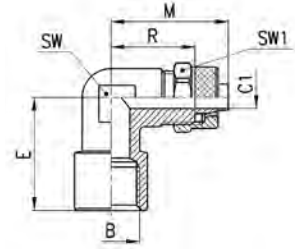

Fittings Mod. 1431

Swivel Male Tee Sprint®

DIMENSIONS

Mod.	Tube	A	C1	E	H	M	R	SW	SW1	SW2	Weight (g)
1431 6/4-1/8	6/4	G1/8	3	15	5.5	22.5	15	10	12	12	32
1431 6/4-1/4	6/4	G1/4	3	15	7	22.5	15	10	12	14	38
1431 8/6-1/8	8/6	G1/8	5	15	5.5	22.5	15	10	14	12	36
1431 8/6-1/4	8/6	G1/4	5	15	7	22.5	15	10	14	14	41
1431 10/8-1/4	10/8	G1/4	6.5	16	7	25.5	17	12	16	14	54

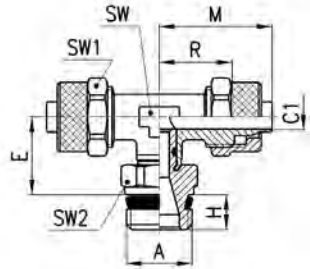

Fittings Mod. 1410

BSPT Fix Male Tee

DIMENSIONS

Mod.	Tube	A	C1	E	H	M	R	SW	SW1	Weight (g)
1410 5/3-1/8	5/3	R1/8	2	12.5	7.5	21.5	15	8	8	16
1410 6/4-1/8	6/4	R1/8	3	12.5	7.5	22.5	15	8	12	25
1410 6/4-1/4	6/4	R1/4	3	15.5	11	22.5	15	10	12	32
1410 8/6-1/8	8/6	R1/8	5	13	7.5	22.5	15	10	14	31
1410 8/6-1/4	8/6	R1/4	5	15.5	11	22.5	15	10	14	35
1410 10/8-1/8	10/8	R1/8	6.5	15	7.5	25.5	17	12	16	47
1410 10/8-1/4	10/8	R1/4	6.5	17	11	25.5	17	12	16	50
1410 10/8-1/2	10/8	R1/2	6.5	21.5	14	28.5	20	16	16	80
1410 12/10-3/8	12/10	R3/8	8.5	19	11.5	30	20	14	19	77
1410 12/10-1/2	12/10	R1/2	8.5	21.5	14	30.5	20.5	16	19	92
1410 15/12.5-1/2	15/12.5	R1/2	11	21.5	14	34	22.5	16	22	107

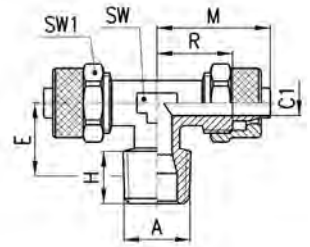

Fittings Mod. 1420

Lateral BSPT Male Tee

DIMENSIONS

Mod.	Tube	A	C1	E	H	L	M	R	SW	SW1	Weight (g)
1420 5/3-1/8	5/3	R1/8	2	12.5	7.5	37.5	21.5	15	8	8	15
1420 6/4-1/8	6/4	R1/8	3	12.5	7.5	38.5	22.5	15	8	12	23
1420 6/4-1/4	6/4	R1/4	3	15.5	11	43	22.5	15	10	12	29
1420 8/6-1/8	8/6	R1/8	5	13	7.5	39	22.5	15	10	14	31
1420 8/6-1/4	8/6	R1/4	5	15.5	11	43	22.5	15	10	14	34
1420 10/8-1/8	10/8	R1/8	6.5	15	7.5	43.5	25.5	17	12	16	46
1420 10/8-1/4	10/8	R1/4	6.5	17	11	47	25.5	17	12	16	50

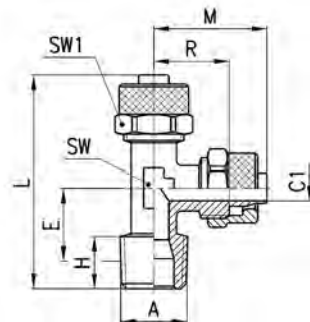

Fittings Mod. 1521

Complete Metric-BSP
Single Adjustable Banjo

DIMENSIONS												
Mod.	Tube	A	C1	H	L	S	M	R	W	SW	SW1	Weight (g)
1521 5/3-M5	5/3	M5	2	3	18	4.5	17	10.5	∅9	8	8	10
1521 5/3-1/8	5/3	G1/8	2	6	27	8.5	22.5	16	∅14	14	8	26
1521 6/4-M5	6/4	M5	3	3	18	4.5	18	10.5	∅9	8	9	11
1521 6/4-1/8	6/4	G1/8	3	6	27	8.5	24	16.5	∅14	14	12	31
1521 6/4-1/4	6/4	G1/4	3	8	29.5	8.5	26	18.5	∅18	17	12	48
1521 6/4-3/8	6/4	G3/8	3	8	30	8.5	28	20.5	∅21	19	12	57
1521 8/6-1/8	8/6	G1/8	5	6	27	8.5	24	16.5	∅14	14	14	34
1521 8/6-1/4	8/6	G1/4	5	8	29.5	8.5	26	18.5	∅18	17	14	46
1521 8/6-3/8	8/6	G3/8	5	8	30	8.5	28	20.5	∅21	19	14	64

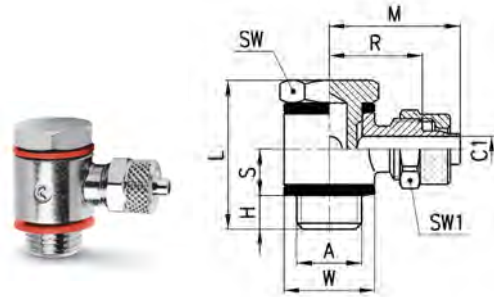

Fittings Mod. 1525

Complete Single
Adjustable Long Banjo

DIMENSIONS												
Mod.	Tube	A	C1	H	L	S	M	R	W	SW	SW1	Weight (g)
1525 6/4-1/8	6/4	G1/8	3	6	31	12.5	24	16.5	∅14	14	12	35
1525 6/4-1/4	6/4	G1/4	3	8	33.5	12.5	26	18.5	∅18	17	12	48
1525 6/4-3/8	6/4	G3/8	3	8	34	12.5	28	20.5	∅21	19	12	60
1525 8/6-1/8	8/6	G1/8	5	6	31	12.5	24	16.5	∅14	14	14	35
1525 8/6-1/4	8/6	G1/4	5	8	33.5	12.5	26	18.5	∅18	17	14	54
1525 8/6-3/8	8/6	G3/8	5	8	34	12.5	28	20.5	∅21	19	14	64
1525 10/8-1/8	10/8	G1/8	6.5	6	31	12.5	25	16.5	∅14	14	16	38
1525 10/8-1/4	10/8	G1/4	6.5	8	33.5	12.5	27	18.5	∅18	17	16	57
1525 10/8-3/8	10/8	G3/8	6.5	8	34	12.5	29.5	21	∅21	19	16	69
1525 10/8-1/2	10/8	G1/2	6.5	9	35	12.5	32	23.5	∅26	27	16	112
1525 12/10-3/8	12/10	G3/8	8	8	34	12.5	31.5	21.5	∅21	19	19	77
1525 12/10-1/2	12/10	G1/2	8.5	9	35	12.5	33.5	23.5	∅26	27	19	111
1525 15/12.5-1/2	15/12.5	G1/2	11	9	35	12.5	36.5	25	∅26	27	22	120

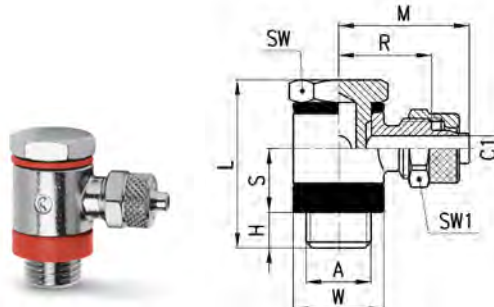

Fittings Mod. 1610

Single Banjo

DIMENSIONS												
Mod.	Tube	C1	M	O	R	V	W	SW1	Weight (g)	assembled with Mod.		
1610 5/3-M5	5/3	2	17	9	10.5	5.1	∅9	8	8	1631, 1635		
1610 5/3-M6	5/3	2	17	9	10.5	5.1	∅9	8	7	SCU, SVU, SCO...		
1610 5/3-1/8	5/3	2	22.5	14.5	16	9.8	∅14	8	13	1631, 1635, SCU, SVU, SCO...		
1610 6/4-M5	6/4	3	18	9	10.5	5.1	∅9	9	8	1631, 1635		
1610 6/4-M6	6/4	2	18	9	10.5	5.1	∅9	9	8	SCU, SVU, SCO...		
1610 6/4-1/8	6/4	3	24	14.5	16.5	9.8	∅14	12	18	1631, 1635, SCU, SVU, SCO...		
1610 6/4-1/4	6/4	3	26	14.5	18.5	13.2	∅18	12	21	1631, 1635, SCU, SVU, SCO...		
1610 6/4-3/8	6/4	3	28	14.5	20.5	16.7	∅21	12	22	1631, 1635, SCU, SVU, SCO...		
1610 8/6-1/8	8/6	5	24	14.5	16.5	9.8	∅14	14	19	1631, 1635, SCU, SVU, SCO...		
1610 8/6-1/4	8/6	5	26	14.5	18.5	13.2	∅18	14	22	1631, 1635, SCU, SVU, SCO...		
1610 8/6-3/8	8/6	5	28	14.5	20.5	16.7	∅21	14	25	1631, 1635, SCU, SVU, SCO...		
1610 10/8-1/8	10/8	6.5	25	14.5	16.5	9.8	∅14	16	25	1635, SCU, SVU, SCO...		
1610 10/8-1/4	10/8	6.5	27	14.5	18.5	13.2	∅18	16	24	1635, SCU, SVU, SCO...		
1610 10/8-3/8	10/8	6.5	29.5	14.5	21	16.7	∅21	16	28	1635, SCU, SVU, SCO...		
1610 10/8-1/2	10/8	6.5	32	14.5	23.5	21	∅26	16	35	1635		
1610 12/10-3/8	12/10	8	31.5	14.5	21.5	16.7	∅21	19	36	1635, SCU, SVU, SCO...		
1610 12/10-1/2	12/10	8.5	33.5	14.5	23.5	21	∅26	19	40	1635		
1610 15/12.5-1/2	15/12.5	11	36.5	14.5	25	21	∅26	22	48	1635		

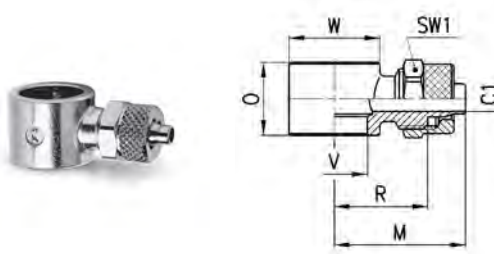

Fittings Mod. 1620

Double Banjo

DIMENSIONS

Mod.	Tube	C1	M	O	R	V	W	SW1	Weight (g)	assembled with Mod.
1620 6/4-M5	6/4	3	18	9	10.5	5.1	∅9	9	12	1631, 1635
1620 6/4-1/8	6/4	3	24	14.5	16.5	9.8	∅14	12	29	1631, 1635, SCU, SVU, SCO...
1620 6/4-1/4	6/4	3	26	14.5	18.5	13.2	∅18	12	31	1631, 1635, SCU, SVU, SCO...
1620 8/6-1/8	8/6	5	24	14.5	16.5	9.8	∅14	14	31	1631, 1635, SCU, SVU, SCO...
1620 8/6-1/4	8/6	5	26	14.5	18.5	13.2	∅18	14	34	1631, 1635, SCU, SVU, SCO...

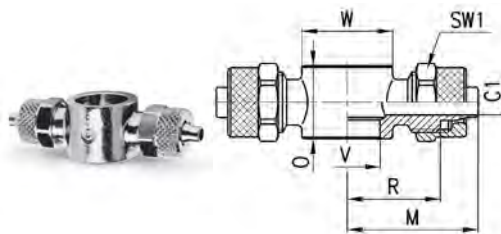

Fittings Mod. 1631 01

Single Banjo Stem

Assembled with adjustable fittings Mod. 6610; 6620; 1610; 1620; 2023; 1170

DIMENSIONS

Mod.	A	H	L	S	SW	Weight (g)
1631 01-M5	M5	4	18	5.5	8	3
1631 01-1/8	G1/8	6	27	8.5	14	13
1631 01-1/4	G1/4	8	29.5	8.5	17	24
1631 01-3/8	G3/8	8	30	8.5	19	35
1631 01-1/2	G1/2	9	31	8.5	27	63

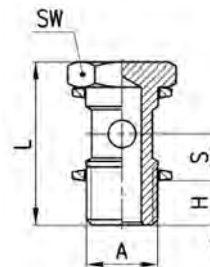

= zinc-plated steel

Fittings Mod. 1635 01

Single Long Banjo Stem

Assembled with adjustable fittings Mod. 6610; 6620; 1610; 1620; 2023; 1170

DIMENSIONS

Mod.	A	H	L	S	SW	Weight (g)
1635 01-1/8	G1/8	6	31	12.5	14	15
1635 01-1/4	G1/4	8	33.5	12.5	17	27
1635 01-3/8	G3/8	8	34	12.5	19	37
1635 01-1/2	G1/2	9	35	12.5	27	71
1635 01-M12x1.25	M12x1.25	8	33.5	12.5	17	27
1635 01-M12x1.5	M12x1.5	8	33.5	12.5	17	27

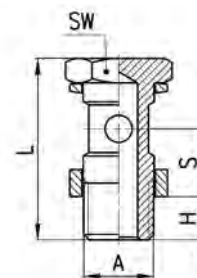

* = models that can be assembled with 1/4 banjo fittings

Fittings Mod. 1631 02

Double Banjo Stem

Assembled with adjustable fittings Mod. 6610; 6620; 1610; 1620; 2023; 1170

DIMENSIONS

Mod.	A	H	L	SW	Weight (g)
1631 02-1/8	G1/8	6	43	14	18
1631 02-1/4	G1/4	8	45.5	17	33
1631 02-3/8	G3/8	8	46	19	48

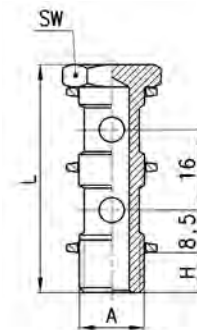

Fittings Mod. 1635 02

Double Long Banjo Stem

Assembled with adjustable fittings Mod. 6610; 6620; 1610; 1620; 2023; 1170

DIMENSIONS

Mod.	A	H	L	SW	Weight (g)
1635 02-1/8	G1/8	6	56	14	26
1635 02-1/4	G1/4	8	58.5	17	33
1635 02-3/8	G3/8	8	59	19	64
1635 02-1/2	G1/2	9	60	27	111

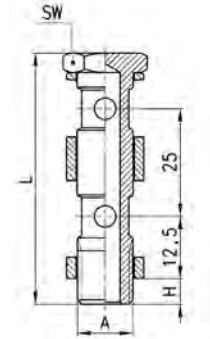

Fittings Mod. 1631 03

Triple Banjo Stem

Assembled with adjustable fittings Mod. 6610; 6620; 1610; 1620; 2023; 1170

DIMENSIONS

Mod.	A	H	L	SW	Weight (g)
1631 03-1/8	G1/8	6	59	14	24
1631 03-1/4	G1/4	8	61.5	17	42
1631 03-3/8	G3/8	8	62	19	62

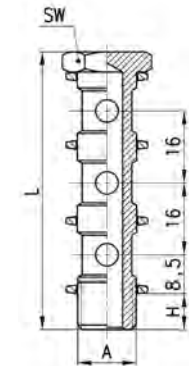

Fittings Mod. 1580

Union Connector

DIMENSIONS

Mod.	Tube	C1	C2	L	R1	R2	SW	SW1	SW2	Weight (g)
1580 5/3	5/3	2	2	28.5	7.5	7.5	8	8	8	8
1580 6/4	6/4	3	3	34.5	10	10	12	12	12	22
1580 8/6	8/6	5	5	34.5	9.75	9.75	13	14	14	28
1580 10/8	10/8	6.5	6.5	38	10.5	10.5	14	16	16	38
1580 12/10	12/10	8.5	8.5	41	10.5	10.5	17	19	19	55
1580 15/12.5	15/12.5	11	11	45	11	11	22	22	22	80
1580 8/6-6/4	8/6-6/4	5	3	34.5	9.75	9.75	13	12	14	24
1580 10/8-6/4	10/8-6/4	6.5	3	36.5	10.5	10	14	12	16	31

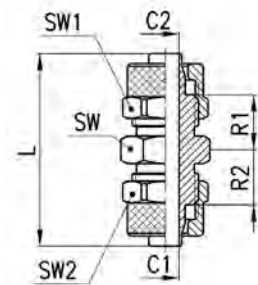

Fittings Mod. 1590

Bulkhead Union Reducer

DIMENSIONS

Mod.	Tube	B	C1	C2	L	R	MAX	SW	SW1	SW2	Weight (g)
1590 5/3	5/3	M7x0.75	2	2	40	27	9	8	8	8	12
1590 6/4	6/4	M10x1	3	3	48	33	14	14	12	12	33
1590 8/6	8/6	M12x1	5	5	48	33	12	17	14	14	43
1590 10/8	10/8	M14x1	6.5	6.5	48	31	10	17	16	16	52
1590 12/10	12/10	M16x1	8.5	8.5	53	33	10	19	19	19	71
1590 6/4-5/3	6/4-5/3	M10x1	3	2	48	34	14	14	12	12	33
1590 8/6-6/4	8/6-6/4	M12x1	5	3	48	33	12	17	14	14	44

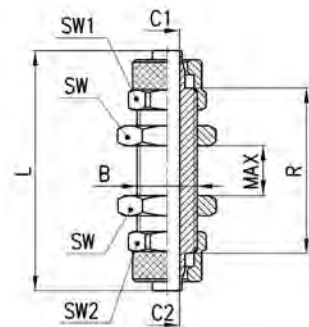

Fittings Mod. 1550
Elbow Connector

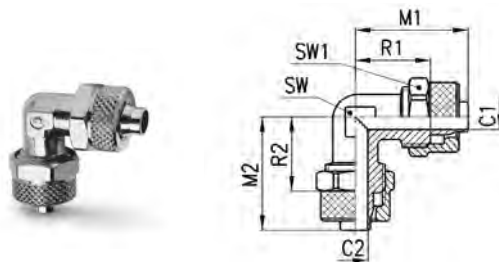

DIMENSIONS

Mod.	Tube	C1	C2	M1	M2	R1	R2	SW	SW1	Weight (g)
1550 6/4	6/4	3	3	22.5	22.5	15	15	8	12	21
1550 8/6	8/6	5	5	22.5	22.5	15	15	10	14	27
1550 10/8	10/8	6.5	6.5	25.5	25.5	17	17	12	16	40
1550 12/10	12/10	8.5	8.5	30	30	20	20	14	19	61
1550 15/12.5	15/12.5	11	11	34	34	22.5	22.5	16	22	88

Fittings Mod. 1540
Tee Connector

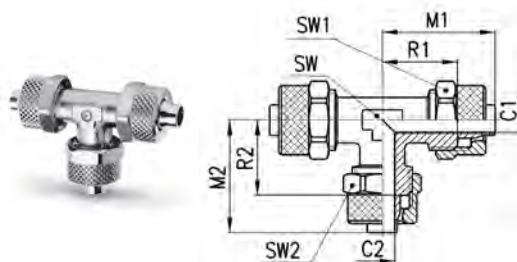

DIMENSIONS

Mod.	Tube	C1	C2	M1	M2	R1	R2	SW	SW1	SW2	Weight (g)
1540 5/3	5/3	2	2	21.5	21.5	15	15	8	8	8	17
1540 6/4	6/4	3	3	22.5	22.5	15	15	8	12	12	31
1540 8/6	8/6	5	5	22.5	22.5	15	15	10	14	14	39
1540 10/8	10/8	6.5	6.5	25.5	25.5	17	17	12	16	16	58
1540 12/10	12/10	8.5	8.5	30	30	20	20	14	19	19	90
1540 15/12.5	15/12.5	11	11	34	34	22.5	22.5	16	22	22	128
1540 8/6-6/4	8/6-6/4	5	3	22.5	22.5	15	15	10	14	12	38
1540 10/8-6/4	10/8-6/4	6.5	3	25.5	23.5	17	16.5	12	16	12	50
1540 10/8-8/6	10/8-8/6	6.5	5	25.5	24	17	16.5	12	16	14	53

Fittings Mod. 1600
Cross Connector

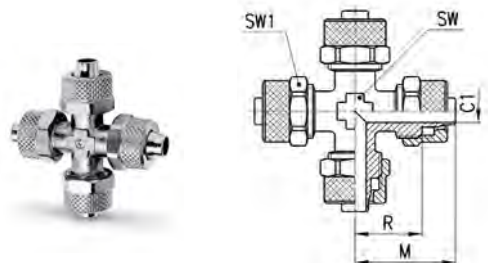

DIMENSIONS

Mod.	Tube	C1	M	R	SW	SW1	Weight (g)
1600 6/4	6/4	3	22.5	15	8	12	41
1600 8/6	8/6	5	22.5	15	10	14	52

Fittings Mod. 1470
Adaptor with Junction

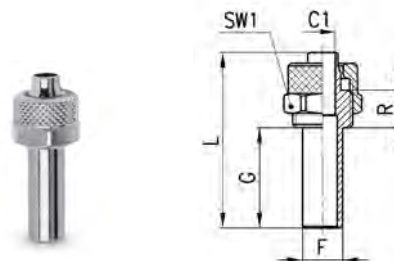

DIMENSIONS

Mod.	Tube	F	C1	G	L	R	SW1	Weight (g)
1470 6/4	6/4	6	3	20	35	7.5	12	11
1470 8/6	8/6	8	5	20	35	7.5	14	15

Accessories Mod. 2651
Aluminium Washer

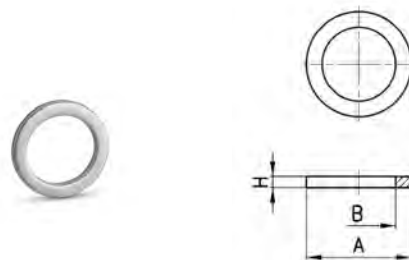

DIMENSIONS				
Mod.	A	B	H	Weight (g)
2651 1/8	14	9.8	1.5	1
2651 1/4	18	13.2	1.5	1
2651 3/8	22	16.7	1.5	1
2651 1/2	26	20.9	1.5	1
2651 1	38.5	33.4	1.5	2

Accessories Mod. 2661
Plastic Washer



DIMENSIONS				
Mod.	A	B	H	Weight (g)
2661 M3	4.9	2.8	0.7	1
2661 M5	8	5.2	1	1
2661 M6	9	6.2	1	1
2661 1/8	14	10.2	1.9	1
2661 1/4	18	13.5	1.9	1
2661 3/8	21	16.5	2.1	1
2661 1/2	26	21.2	1.9	1

Accessories Mod. 2665
Plastic Washer

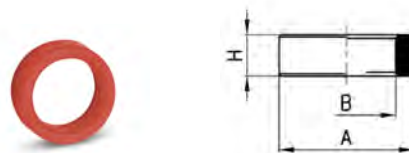

DIMENSIONS				
Mod.	A	B	H	Weight (g)
2665 1/8	14	9.8	5	1
2665 1/4	18	13.2	5	1
2665 3/8	21	16.8	5	1
2665 1/2	26	21.1	5	1

Accessories Mod. 2669
Plastic Washer

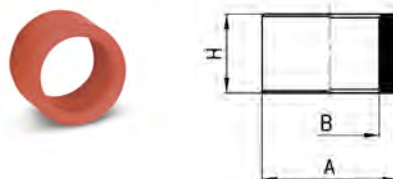

DIMENSIONS				
Mod.	A	B	H	Weight (g)
2669 1/8	14	9.8	10	1
2669 1/4	18	13.2	10	2
2669 3/8	21	16.8	10	2
2669 1/2	26	21.1	10	2

Accessories Mod. 1703

Blocking nut

DIMENSIONS							
Mod.	Tube	B	D	D1	L	SW1	Weight (g)
1703 5/3-M7x0.75	5/3	M7x0.75	5.1	8.8	8.5	8	1
1703 6/4-M8x0.75	6/4	M8x0.75	6.1	9.8	8.5	9	2
1703 6/4-M10x1	6/4	M10x1	6.1	13.3	10	12	4
1703 8/6-M12x1	8/6	M12x1	8.2	15.5	10	14	5
1703 10/8-M14x1	10/8	M14x1	10.15	17.5	13	16	8
1703 12/10-M16x1	12/10	M16x1	12.2	21	13.5	19	12
1703 15/12.5-M20x1	15/12.5	M20x1	15.2	24.5	16	22	15

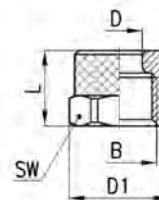

Accessories Mod. 1723

Blocking nut with metal spring

DIMENSIONS									
Mod.	Tube	B	F	D	D1	G	L	SW	Weight (g)
1723 6/4-M10x1	6/4	M10x1	8.9	6.1	13.3	18	90.5	12	15
1723 8/6-M12x1	8/6	M12x1	10.9	8.2	15.5	18	94.5	14	23
1723 10/8-M14x1	10/8	M14x1	12.5	10.15	17.5	22	96.5	16	29
1723 12/10-M16x1	12/10	M16x1	15.5	12.2	21	23.5	108	19	46
1723 15/12.5-M20x1	15/12.5	M20x1	18.5	15.2	24.5	28	120	22	57

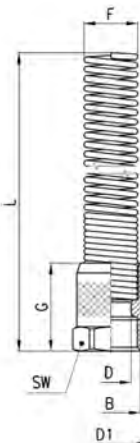

4 Flow Control Valves

Swivel Nickel-Plated Brass Flow Control Valves
Series GSCU, GMCU, GSVU, GMVU, GSCO, GMCO



Swivel Design: Meter-Out, Meter-In and Needle Orifice
Tube Diameter OD: 1/8", 5/32", 1/4", 5/16", 3/8", 3mm, 4mm, 6mm, 8mm, 10mm
Thread Type: 10-32 UNF, 1/8", 1/4", 3/8", 1/2" NPTF
Metric M5, G1/8 and G1/4

Fixed Banjo-Style Nickel-Plated Brass Flow Control Valve
Bodies and Adjustable Exhaust Controllers
Series SCU, MCU, SVU, MVU, SCO, MCO



Non-Swivel Design: Meter-Out, Meter-In and Needle Orifice
Tube Diameter OD: 4mm, 5mm, 6mm, 8mm, 10mm, 12mm
(banjo fittings required)
Thread Type: Metric (M5), BSP (G1/8, G1/4, G3/8, G1/2),
thread adapters required for BSPT/R

Swivel Composite Flow Control Valves
Series TMCU, TMVU, TMC0



Swivel Design: Meter-Out, Meter-In and Needle Orifice
Tube Diameter OD: 5/32", 1/4", 5/16", 3/8", 4mm, 6mm, 8mm, 10mm
Thread Type: 1/8", 1/4", 3/8", 1/2" NPTF with Pro-Fit® Seal
BSP (G1/8, G1/4, G3/8, G1/2) with Spot-Face O-ring
Seal

Fixed Banjo-Style Composite Right Angle
Flow Control Valves
Series PSCU, PMCU, PSVU, PMVU, PSCO, PMCO



Non-Swivel Design: Meter-Out, Meter-In and Needle Orifice
Tube Diameter OD: 4mm, 6mm, 8mm, 10mm, 12mm
Thread Type: Metric (M5), BSP (G1/8, G1/4, G3/8) with Spot-Face O-ring Seal

In-line Flow Control Valves
Series RFU - RFO



Panel/Wall-Mount Design: Meter-Out, Meter-In
Needle-Orifice
Thread Type: 10-32 UNF, 1/8", 1/4", NPTF
Metric M5, G1/8, G1/4, G3/8 and G1/2

Nickel-Plated Brass Needle Valves
BSP/Metric, Series 28



Panel/Wall-Mount Design: Needle-Orifice
Thread Type: G1/8, G1/4, G3/8, G1/2

Camozzi Flow Control Valves (NPTF Models)



			METER OUT			METER IN		
OD	FEMALE BANJO THREAD	THREAD	GMCU MANUAL ADJ. SWIVEL	GSCU SCREWDRIVER ADJ. SWIVEL	TMCU* MANUAL ADJ. SWIVEL	GMVU MANUAL ADJ. SWIVEL	GSVU SCREWDRIVER ADJ. SWIVEL	TMVU* MANUAL ADJ. SWIVEL
	10-32 UNF	10-32 UNF	GMCU 32F-32	SCU 32F-32		MVU 32F-32	SVU 32F-32	
5/32		1/8	GMCU 53-02	GSCU 53-02	TMCU 53-02	GMVU 53-02	GSVU 53-02	TMVU 53-02
5/32		10-32	GMCU 53-32	GSCU 53-32		MVU 53-32	GSVU 53-32	
1/8		1/8	GMCU 02-02	GSCU 02-02		GMVU 02-02	GSVU 02-02	
	1/8	1/8	GMCU 02F-02	GSCU 02F-02		GMVU 02F-02	GSVU 02F-02	
1/4		1/8	GMCU 04-02	GSCU 04-02	TMCU 04-02	GMVU 04-02	GSVU 04-02	TMVU 04-02
1/4		1/4	GMCU 04-04	GSCU 04-04	TMCU 04-04	GMVU 04-04	GSVU 04-04	TMVU 04-04
	1/4	1/4	GMCU 04F-04	GSCU 04F-04		GMVU 04F-04	GSVU 04F-04	
5/16		1/8	GMCU 05-02	GSCU 05-02		GMVU 05-02	GSVU 05-02	
5/16		1/4	GMCU 05-04	GSCU 05-04	TMCU 05-04	GMVU 05-04	GSVU 05-04	TMVU 05-04
5/16		3/8	GMCU 05-06	GSCU 05-06	TMCU 05-06	GMVU 05-06	GSVU 05-06	TMVU 05-06
3/8		1/4	GMCU 06-04	GSCU 06-04	TMCU 06-04	GMVU 06-04	GSVU 06-04	TMVU 06-04
3/8		3/8	GMCU 06-06	GSCU 06-06	TMCU 06-06	GMVU 06-06	GSVU 06-06	TMVU 06-06
3/8		1/2			TMCU 06-08			TMVU 06-08
	3/8	3/8	GMCU 06F-06	GSCU 06F-06		GMVU 06F-06	GSVU 06F-06	
	1/2	1/2	MCU 08F-08	SCU 08F-08		MVU 08F-08	SVU 08F-08	

Camozzi Flow Control Valve Advantages:

- Linear flow curves for more precise control
- Up to 22 turns of adjustment for higher resolution
- Metal tube collets for greater durability



NEEDLE VALVE

OD	FEMALE BANJO THREAD	THREAD	GMCO MANUAL ADJ. SWIVEL	GSCO SCREWDRIVER ADJ. SWIVEL	TMCO* MANUAL ADJ. SWIVEL
	10-32 UNF	10-32 UNF	MCO 32F-32	SCO 32F-32	
5/32		1/8	GMCO 53-02	GSCO 53-02	TMCO 53-02
5/32		10-32	MCO 53-32	SCO 53-32	
1/8		1/8	GMCO 02-02	GSCO 02-02	
	1/8	1/8	GMCO 02F-02	GSCO 02F-02	
1/4		1/8	GMCO 04-02	GSCO 04-02	TMCO 04-02
1/4		1/4	MCO 04-04	GSCO 04-04	TMCO 04-04
	1/4	1/4	MCO 04F-04	GSCO 04F-04	
5/16		1/8	GMCO 05-02	GSCO 05-02	
5/16		1/4	MCO 05-04	GSCO 05-04	TMCO 05-04
5/16		3/8			TMCO 05-06
3/8		1/4	MCO 06-04	GSCO 06-04	TMCO 06-04
3/8		3/8			TMCO 06-06
3/8		1/2			TMCO 06-08
	3/8	3/8			
	1/2	1/2	MCO 08F-08	SCO 08F-08	

* TMCU, TMVU and TMCO models feature composite bodies and **Pro-Fit** threads.

A complete range of Metric/BSP flow control valves are also available.

Swivel Nickel-Plated Brass Right Angle Flow Control Valves

Series GSCU, GMCU, GSVU, GMVU, GSCO, GMCO

Meter-Out, Meter-In and Needle Orifice
 Tube Diameter OD: 1/8", 5/32", 1/4", 5/16", 3/8"
 3mm, 4mm, 6mm, 8mm, 10mm
 Thread Type : 10-32 UNF, 1/8", 1/4", 3/8", 1/2" NPTF
 M5 Metric, 1/8, 1/4 BSP



These unidirectional and bidirectional flow controllers have been designed as small as possible to enable mounting directly on valves or cylinders. The flow regulation range is wide and gradual, allowing the regulation to be very accurate either at minimum or maximum flow.

GENERAL DATA

Construction	needle - type
Valve group	Unidirectional and bidirectional controller (meter-in, meter-out, and needle valve)
Materials	Nickel-plated brass body, Buna-N seals, Nylon gaskets
Mounting	Right-angle male thread
Installation	in any position
Operating temperature	32° - 175° F (dry air necessary down to - 4° F)
Operating pressure	1 - 10 bar (14.5 to 145 psi)
Nominal pressure	6 bar (87 psi)
Nominal flow	see graph
Nominal diameter	10-32 UNF = 1.5mm (.059"), 1/8" = 2 mm (.079") 1/4" = 4 mm (.157"), 3/8" = 7 mm (.275") M5 = 1.5mm G1/8 = 2 mm - G1/4 = 4 mm G3/8 = 7 mm - G1/2 = 12 mm
Fluid	filtered air
Lubricant	Oil compatible with Buna-N (3° - 10° E)
	*QN flowrate (SCFM) determined with a supply pressure of 6 bar (87 psi) and with a pressure drop of 1 bar (14.5 psi). **Dimensions are in inches

Nickel-Plated Brass Flow-Control Valves:

4



Features

- Nickel-Plated, All-metal Collet and Release ring
- All-Metal, Nickel-Plated body and Threads,
- Compact Brass bodies from Brass forgings
- Specialized O-ring choices for High-Temp, Low-Temp, Special Fluids, Food-Grade compatibility
- Multiple Thread sealant systems: Vibra-Seal Coated (Optional), Std NPTF & O-Ring Spot Face seals
- Broad Range of configurations
- Removable Collet and tube o-rings
- Highly accurate Flow-rate repeatability & Higher Flow
- Manual Adjustment knob w/ internal hex-key slot or Screw-Driver slot
- Hex Locking-nut
- Precise Manual knob, w/ Internal hex-key
- Full Swivel design, NPTF and Metric/BSP, with integrated Push-In Fittings or Female thread ports
- Alternate Non-Swivel design with Banjo Tube connections and thread adapters
- Meter-IN, Meter-OUT and Needle-Orifice flow designs for assembly on valves, cylinders or in-line use
- Alternate sintered bronze banjo for fully adjustable silencer/muffler with speed control for exhaust port mounting, (see Part No. 2905 to add to any banjo flow control body)

Benefits

Collet

- Won't break like plastic release rings and bodies; More Durable design
- Higher holding force, with easier release
- Won't scratch tubes like "bite-ring" designs
- Less chance of micro-leakage and bubble-leaks over time due to damaged tubing

Body

- Resistant to UV exposure
- Better resistance to stress-cracking, abrasion, solvents, detergents, hydrocarbons and other fluid media
- Simplified manifold circuits with broader variety of fitting combinations and shapes to select
- Lighter weight for End-of-Arm tooling & Robotic handling,
- Compact design reduces overall dimensions for valve & cylinder assemblies, packaging applications and control cabinets
- 25 % Reduction in overall Body size, compared to previous Brass-Banjo line

Design

- Accuracy and Repeatability of Flow-Control valves allows timing circuits to be design, faster OEM set-up and simplified MRO field installation and replacements
- Simplified manifold circuits with broader variety of Tube - Thread combinations to select
- Lighter weight for End-of-Arm tooling & Robotic handling
- Compact design reduces overall dimensions for valve assemblies, packaging applications and control cabinets
- More compact flow capacity reduces cylinder spacing with improved overall speed
- Fine tuning of flow with manual knob or screw-driver adjustment
- Convertible into "Tamper-Proof" by removing manual knob or sealing screw-driver slot
- Interchangeable Inch and Metric Tube O.D. banjo connections and thread adapters for "hybrid" Fittings and Flow-control valve requirements

INCH / NPT CODING EXAMPLE

GM	CU	04	-	02
-----------	-----------	-----------	----------	-----------

GM	<p>ACTUATION: GM = swivel body, manual adjustment GS = swivel body, screwdriver adjustment M = manual adjustment, non-swivel banjo S = screwdriver adjustment, non-swivel banjo</p>
CU	<p>ASSEMBLY: CU = on cylinders (meter out) VU = on valves (meter in) CO = (needle orifice)</p>
04	<p>ATTACHMENTS 32F = 10-32 UNF Female Thread 53 = 5/32" OD Tube 02 = 1/8" OD Tube 02F = 1/8" NPTF Female Thread 04 = 1/4" OD Tube 04F = 1/4" NPTF Female Thread 05 = 5/16" OD Tube 06 = 3/8" OD Tube 06F = 3/8" NPTF Female Thread 08 = 1/2" OD Tube 08F = 1/2" NPTF Female Thread</p>
02	<p>Thread 32 = 10-32 UNF 02 = 1/8" NPTF 04 = 1/4" NPTF 06 = 3/8" NPTF 08 = 1/2" NPTF</p>

METRIC / BSP CODING EXAMPLE

GM	CU	9	03	-	1/8	-	6
-----------	-----------	----------	-----------	----------	------------	----------	----------

GM	<p>ACTUATION ADJUSTMENT: GM = manual GS = screwdriver adjustment</p>																					
CU	<p>ASSEMBLY: CU = on cylinders unidirectional, meter out VU = on valves unidirectional, meter in CO = bidirectional, needle orifice</p>																					
9	<p>VERSIONS: 8 = needle (screwdriver operated) 9 = needle (manually operated)</p>																					
03	<p>FLOW CONTROL RANGE:</p> <table border="1"> <thead> <tr> <th></th> <th>Orifice</th> <th>∅ tube</th> </tr> </thead> <tbody> <tr> <td>13 =</td> <td>1.5</td> <td>3</td> </tr> <tr> <td>14 =</td> <td>1.5</td> <td>4</td> </tr> <tr> <td>03 =</td> <td>3.5</td> <td>6</td> </tr> <tr> <td>04 =</td> <td>3.5</td> <td>8</td> </tr> <tr> <td>05 =</td> <td>5</td> <td>8</td> </tr> <tr> <td>06 =</td> <td>5</td> <td>10</td> </tr> </tbody> </table>		Orifice	∅ tube	13 =	1.5	3	14 =	1.5	4	03 =	3.5	6	04 =	3.5	8	05 =	5	8	06 =	5	10
	Orifice	∅ tube																				
13 =	1.5	3																				
14 =	1.5	4																				
03 =	3.5	6																				
04 =	3.5	8																				
05 =	5	8																				
06 =	5	10																				
1/8	<p>PORTS: M5 G1/8 G1/4</p>																					
6	<p>∅ TUBE: 3mm 4mm 6mm 8mm 10mm</p>																					

To ensure the right choice of unidirectional flow controller, proceed as follows: calculate the quantity of air in NL/min (see cylinder Table); determine the stroke time of the cylinder; refer to graph to see which controller is the right type.

METER IN, METER OUT, NEEDLE ORIFICE FLOW CONTROLLERS

To ensure the right choice of unidirectional flow controller, proceed as follows: calculate the quantity of air in NL/min (see cylinder Table); determine the stroke time of the cylinder; refer to graph to see which controller is the right type. In the case of bidirectional regulators, refer to the graph and check whether the flow control range is suitable for the work required. (NB: Qn is determined with a supply pressure of 6 bar and with DP = 1 bar at the outlet. N° = number of screw turns.)

INCH / NPTF

5/32

Flow Qn (NL/min.) from B → A with needle OPEN:	60 NL/min. (2.12 SCFM)
Flow Qn (NL/min.) from B → A with needle CLOSED:	43 NL/min. (1.52 SCFM)

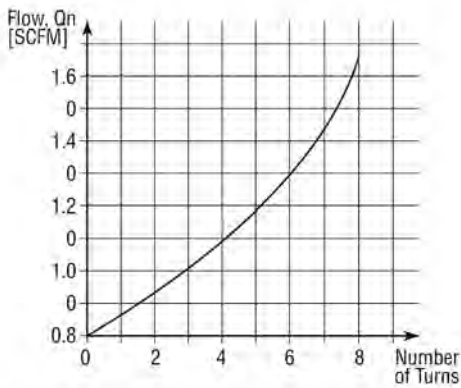

04-02

Flow Qn (NL/min.) from B → A with needle OPEN:	164 NL/min. (5.79 SCFM)
Flow Qn (NL/min.) from B → A with needle CLOSED:	33.0 NL/min. (1.17 SCFM)

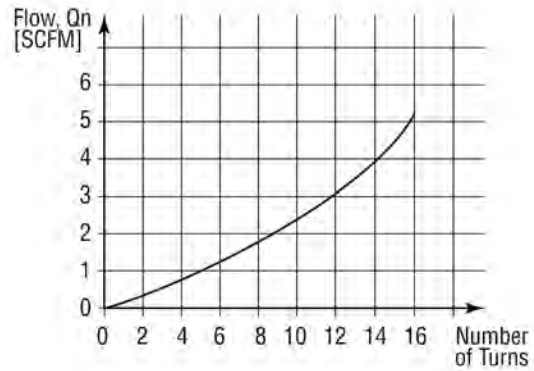

53-02

Flow Qn (NL/min.) from B → A with needle OPEN:	107 NL/min (3.78 SCFM)
Flow Qn (NL/min.) from B → A with needle CLOSED:	28.3 NL/min. (1.0 SCFM)

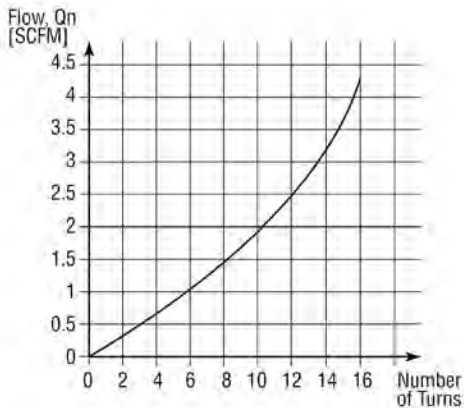

04-04

Flow Qn (NL/min.) from B → A with needle OPEN:	367 NL/min (12.96 SCFM)
Flow Qn (NL/min.) from B → A with needle CLOSED:	133.0 NL/min (4.71 SCFM)

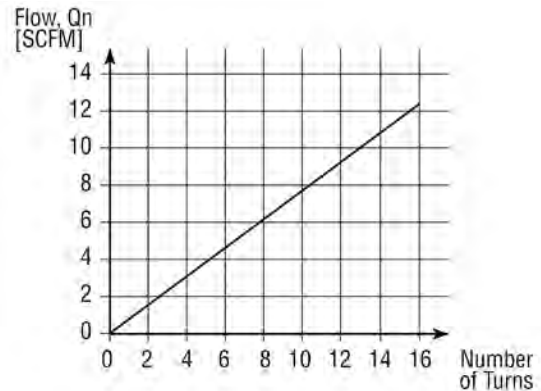

METER IN, METER OUT, NEEDLE ORIFICE FLOW CONTROLLERS

To ensure the right choice of unidirectional flow controller, proceed as follows: calculate the quantity of air in NL/min (see cylinder Table); determine the stroke time of the cylinder; refer to graph to see which controller is the right type. In the case of bidirectional regulators, refer to the graph and check whether the flow control range is suitable for the work required. (NB: Qn is determined with a supply pressure of 6 bar and with DP = 1 bar at the outlet. N° = number of screw turns.)

INCH / NPTF

06-04

Flow Qn (NL/min.) from B → A with needle OPEN: 466 NL/min. (16.45 SCFM)
 Flow Qn (NL/min.) from B → A with needle CLOSED: 153 NL/min. (5.40 SCFM)

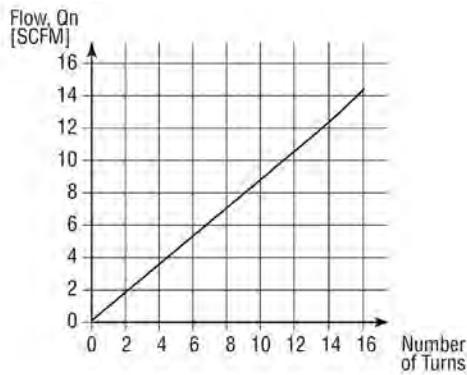

06-06

Flow Qn (NL/min.) from B → A with needle OPEN: 875 NL/min. (30.90 SCFM)
 Flow Qn (NL/min.) from B → A with needle CLOSED: 428 NL/min. (15.11 SCFM)

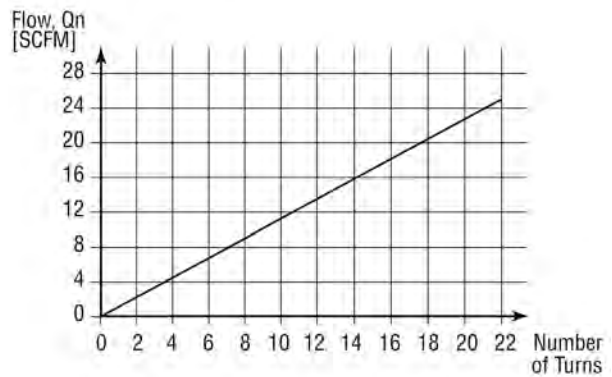

08-08

Flow Qn (NL/min.) from 2 → 1 with needle OPEN: 2570 (90.75 SCFM)
 Flow Qn (NL/min.) from 2 → 1 with needle CLOSED: 1330 (46.95 SCFM)
 NB: Qn is determined with a supply pressure of 6 bar and with ΔP = 1 bar at the outlet
 N° = number of screw turns.

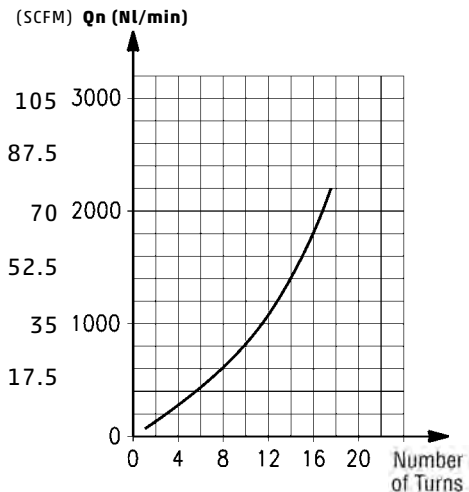

METRIC / BSP

M5

Flow Qn (NL/min.) from 2 → 1 with controller OPEN: 70
 Flow Qn (NL/min.) from 2 → 1 with controller CLOSED: 33

N° = number of screw turns
 NB: Qn is determined with a supply pressure of 6 bar and with ΔP = 1 bar at the outlet.

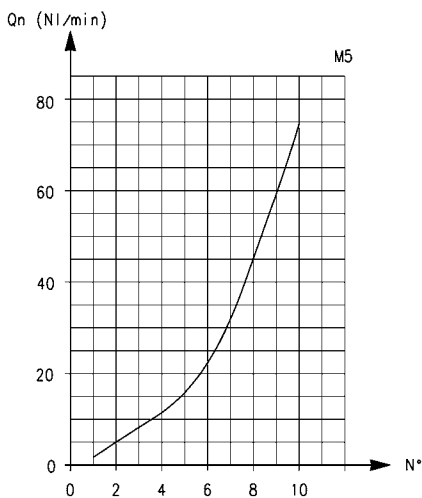

G1/8

Flow Qn (NL/min.) from 2 → 1 with controller OPEN: 440
 Flow Qn (NL/min.) from 2 → 1 with controller CLOSED: 170

N° = number of screw turns
 NB: Qn is determined with a supply pressure of 6 bar and with ΔP = 1 bar at the outlet.

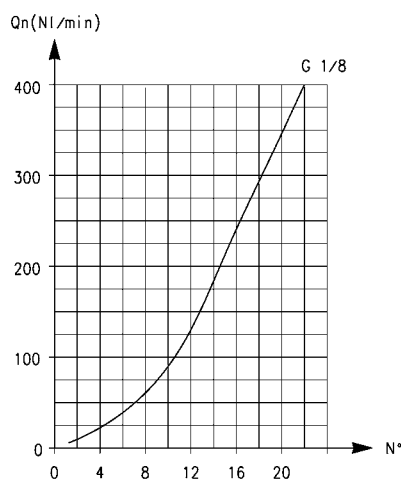

G1/4

Flow Qn (NL/min.) from 2 → 1 with controller OPEN: 790
 Flow Qn (NL/min.) from 2 → 1 with controller CLOSED: 460

N° = number of screw turns
 NB: Qn is determined with a supply pressure of 6 bar and with ΔP = 1 bar at the outlet.

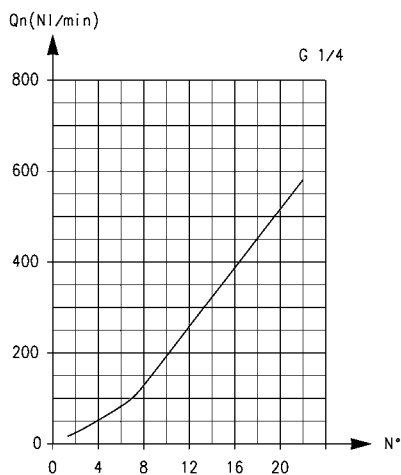

Meter-Out Valves Series GSCU

Meter-out unidirectional flow controller for mounting on cylinders or valves. It has a screwdriver adjustment with a right-angle push to connect tube fitting.

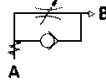

DIMENSIONS (in inches)									
Model	A UNF	B OD	C	S	H	L	M	F	SW
GSCU 53-32	10-32	5/32	.307	.433	.177	1.080	.709	.346	.315

DIMENSIONS (in inches)							
Model	A OD	D NPTF	S	H	L	M	SW
GSCU 02-02	1/8	1/8	.781	.315	1.441	.846	.551
GSCU 53-02	5/32	1/8	.781	.315	1.441	.885	.551
GSCU 04-02	1/4	1/8	.781	.315	1.441	.984	.551
GSCU 04-04	1/4	1/4	.939	.472	1.594	1.063	.748
GSCU 05-02	5/16	1/8	.781	.315	1.441	1.004	.551
GSCU 05-04	5/16	1/4	.939	.472	1.594	1.083	.748
GSCU 05-06	5/16	3/8	.961	.472	1.791	1.122	.866
GSCU 06-04	3/8	1/4	.939	.472	1.594	1.181	.748
GSCU 06-06	3/8	3/8	.961	.472	1.791	1.240	.866

DIMENSIONS								
Model	A	B	S	H	L	M	F	SW
GSCU 813-M5-3	M5	3	12	3	27.5	12.5	6.5	8
GSCU 814-M5-4	M5	4	12	3	27.5	19	8.8	8
GSCU 803-1/8-6	G1/8	6	22.5	5	50	26.5	13	14
GSCU 804-1/8-8	G1/8	8	22.5	5	50	28	15	14
GSCU 805-1/4-8	G1/4	8	27	7	67.5	28.5	15	19
GSCU 806-1/4-10	G1/4	10	27	7	67.5	31	17.5	19



NPTF Threads

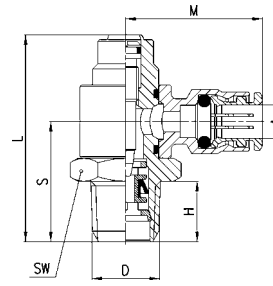
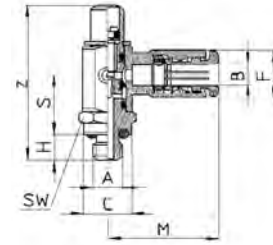

BSP Threads

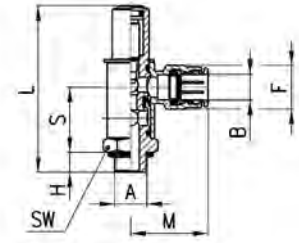

Meter-Out Valves Female-Threaded Banjo Series GSCU

Meter-out unidirectional flow controller for mounting on cylinders or valves. It has screwdriver adjustment with right-angle female threads.

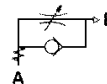

DIMENSIONS (in inches)							
Model	A NPTF	D NPTF	H	S	L	M	SW
GSCU 02F-02	1/8	1/8	0.315	0.768	1.449	0.787	0.551
GSCU 04F-04	1/4	1/4	0.472	0.925	1.614	1.004	0.748
GSCU 06F-06	3/8	3/8	0.472	0.945	1.803	1.102	0.866



NPTF Threads

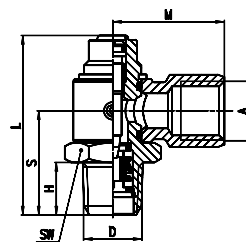

Meter-Out Valves Series GMCU

Meter-out unidirectional flow controller for mounting on cylinders or valves. It has a manual adjustment with a right-angle push to connect tube fitting.

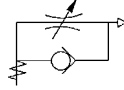

DIMENSIONS (in inches)

Model	A UNF	B OD	C	S	H	L	Z	M	F	SW	SW1
GMCU 53-32	10-32	5/32	.307	.433	.177	1.448	1.614	.709	.346	.315	.217

DIMENSIONS (in inches)

Model	A OD	D NPTF	S	H	L	Z	M	SW	SW1
GMCU 02-02	1/8	1/8	.781	.175	1.775	2.011	.846	.551	.275
GMCU 53-02	5/32	1/8	.781	.315	1.775	2.011	.885	.551	.275
GMCU 04-02	1/4	1/8	.781	.315	1.775	2.011	.984	.551	.275
GMCU 04-04	1/4	1/4	.939	.472	1.994	2.227	1.063	.748	.275
GMCU 05-02	5/16	1/8	.781	.315	1.775	2.011	1.004	.551	.275
GMCU 05-04	5/16	1/4	.939	.472	1.994	2.227	1.083	.748	.275
GMCU 05-06	5/16	3/8	.961	.472	2.223	2.538	1.122	.866	.393
GMCU 06-04	3/8	1/4	.939	.472	1.994	2.227	1.181	.748	.275
GMCU 06-06	3/8	3/8	.961	.472	2.223	2.538	1.240	.866	.393

DIMENSIONS

Model	A	B	S	H	L	Z	M	F	SW	SW1
GMCU 913-M5-3	M5	3	12	3	37	42.5	12.5	6.5	8	5.5
GMCU 914-M5-4	M5	4	12	3	37	42.5	19	8.8	8	5.5
GMCU 903-1/8-6	G1/8	6	22.5	5	65.5	72.5	26.5	13	14	7
GMCU 904-1/8-8	G1/8	8	22.5	5	65.5	72.5	28	15	14	7
GMCU 905-1/4-8	G1/4	8	27	7	85	97.5	28.5	15	19	10
GMCU 906-1/4-10	G1/4	10	27	7	85	97.5	31	17.5	19	10

Meter-Out Valves Series GMCU Female Threaded

Meter-out unidirectional flow controller for mounting cylinders or valves. It has a manual adjustment with right-angle female threads.

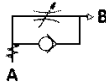

DIMENSIONS (in inches)

Model	A UNF	B UNF	C	S	H	L	Z	M	F	SW	SW1
GMCU 32F-32	10-32	10-32	.307	.433	.177	1.448	1.614	.433	.256	.315	.217

DIMENSIONS

Model	A NPTF	D NPTF	H	S	L	Z	M	SW	SW1
GMCU 02F-02	1/8"	1/8"	0.315	0.768	2.031	1.815	0.787	0.551	0.276
GMCU 04F-04	1/4"	1/4"	0.472	0.925	2.224	1.992	1.004	0.748	0.276
GMCU 06F-06	3/8"	3/8"	0.472	0.945	2.610	2.291	1.102	0.866	0.394

NPTF Threads

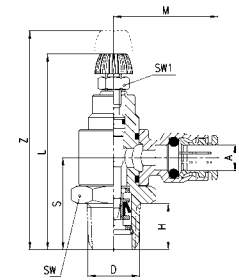
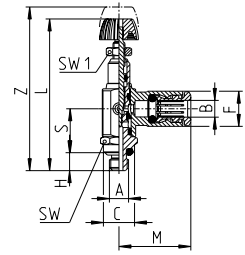

BSP Threads

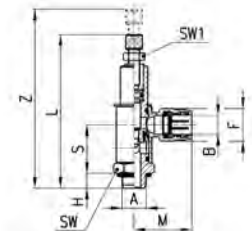

NPTF Threads

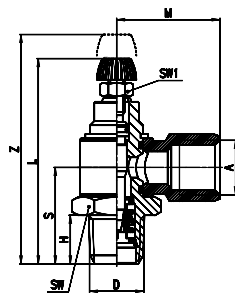
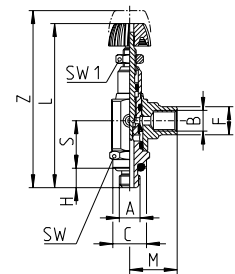

Meter-In Valves Series GSVU

Meter-in unidirectional flow control designed to be mounted on cylinders or valves. It has a screwdriver adjustment with a right-angle push to connect tube fitting.

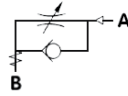

DIMENSIONS (in inches)

Model	A UNF	B OD	C	S	H	L	M	F	SW
GSVU 53-32	10-32	5/32	.307	.433	.177	1.080	.709	.346	.315

DIMENSIONS

Model	A OD	D NPTF	S	H	L	M	SW
GSVU 02-02	1/8	1/8	.781	.315	1.441	.846	.551
GSVU 53-02	5/32	1/8	.781	.315	1.441	.885	.551
GSVU 04-02	1/4	1/8	.781	.315	1.441	.984	.551
GSVU 04-04	1/4	1/4	.939	.472	1.594	1.063	.748
GSVU 05-02	5/16	1/8	.781	.315	1.441	1.004	.551
GSVU 05-04	5/16	1/4	.939	.472	1.594	1.083	.748
GSVU 05-06	5/16	3/8	.961	.472	1.791	1.122	.866
GSVU 06-04	3/8	1/4	.939	.472	1.594	1.181	.748
GSVU 06-06	3/8	3/8	.961	.472	1.791	1.240	.866

DIMENSIONS

Model	A	B	S	H	L	M	F	SW
GSVU 813-M5-3	M5	3	12	3	27.5	12.5	6.5	8
GSVU 814-M5-4	M5	4	12	3	27.5	19	8.8	8
GSVU 803-1/8-6	G1/8	6	22.5	5	50	26.5	13	14
GSVU 804-1/8-8	G1/8	8	22.5	5	50	28	15	14
GSVU 805-1/4-8	G1/4	8	27	7	67.5	28.5	15	19
GSVU 806-1/4-10	G1/4	10	27	7	67.5	31	17.5	19

NPTF Threads

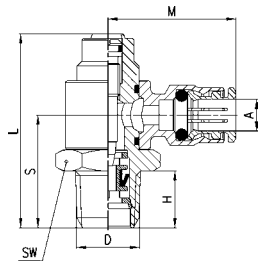
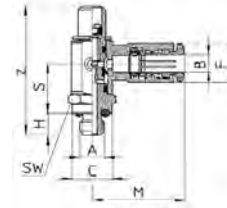

BSP Threads

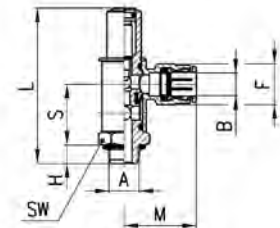

Meter-In Valves Series GSVU

Meter-in unidirectional flow control designed to be mounted on valves or cylinders. It has a screwdriver adjustment with right-angle female threads.

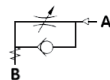

DIMENSIONS (in inches)

Model	A NPTF	D NPTF	H	S	L	M	SW
GSVU 02F-02	1/8	1/8	0.315	0.768	1.449	0.787	0.551
GSVU 04F-04	1/4	1/4	0.472	0.925	1.614	1.004	0.748
GSCV 06F-06	3/8	3/8	0.472	0.945	1.803	1.102	0.866

NPTF Threads

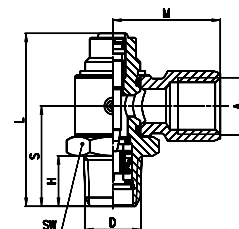

Meter-In Valves Series GMVU

Meter-in unidirectional flow control designed to be mounted on valves or cylinders. It has a manual adjustment with a right-angle push to connect tube fitting.

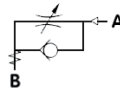

NPTF Threads

DIMENSIONS (in inches)									
Model	A OD	D NPTF	S	H	L	Z	M	SW	SW1
GMVU 02-02	1/8	1/8	.781	.175	1.775	2.011	.846	.551	.275
GMVU 53-02	5/32	1/8	.781	.315	1.775	2.011	.885	.551	.275
GMVU 04-02	1/4	1/8	.781	.315	1.775	2.011	.984	.551	.275
GMVU 04-04	1/4	1/4	.939	.472	1.994	2.227	1.063	.748	.275
GMVU 05-02	5/16	1/8	.781	.315	1.775	2.011	1.004	.551	.275
GMVU 05-04	5/16	1/4	.939	.472	1.994	2.227	1.083	.748	.275
GMVU 05-06	5/16	3/8	.961	.472	2.223	2.538	1.122	.866	.393
GMVU 06-04	3/8	1/4	.939	.472	1.994	2.227	1.181	.748	.275
GMVU 06-06	3/8	3/8	xxx	xxx	xxx	xxx	xxx	xxx	xxx

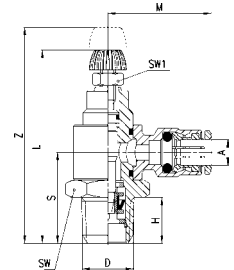

BSP Threads

DIMENSIONS										
Model	A	B	S	H	L	Z	M	F	SW	SW1
GMVU 913-M5-3	M5	3	12	3	37	42.5	12.5	6.5	8	5.5
GMVU 914-M5-4	M5	4	12	3	37	42.5	19	8.8	8	5.5
GMVU 903-1/8-6	G1/8	6	22.5	5	50	72.5	26	13	14	7
GMVU 904-1/8-8	G1/8	8	22.5	5	50	72.5	28	15	14	7
GMVU 905-1/4-8	G1/4	8	27	7	67.5	97.5	29	15	19	10
GMVU 906-1/4-10	G1/4	10	27	7	67.5	97.5	31	17.5	19	10

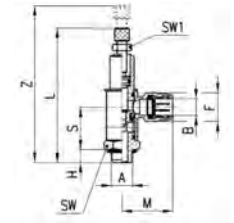

Meter-In Valves Series GMVU

Meter-in unidirectional flow control designed to be mounted on valves or cylinders. It has a manual adjustment with right-angle female threads.

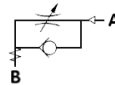

NPTF Threads

DIMENSIONS (in inches)									
Model	A NPTF	D NPTF	H	S	L	Z	M	SW	SW1
GMVU 02F-02	1/8	1/8	0.315	0.768	2.031	1.815	0.787	0.551	0.276
GMVU 04F-04	1/4	1/4	0.472	0.925	2.224	1.992	1.004	0.748	0.276
GMVU 06F-06	3/8	3/8	0.472	0.945	2.610	2.291	1.102	0.866	0.394

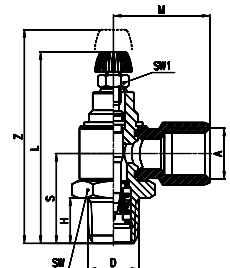

Needle Orifice Valves Series GSCO

This needle-orifice bidirectional flow control is designed with a needle orifice. It has a screwdriver adjustment with a right-angle push to connect tube fitting.



DIMENSIONS (in inches)							
Model	A OD	D NPTF	S	H	L	M	SW
GSCO 02-02	1/8	1/8	.781	.315	1.441	.846	.551
GSCO 53-02	5/32	1/8	.781	.315	1.441	.885	.551
GSCO 04-02	1/4	1/8	.781	.315	1.441	.984	.551
GSCO 04-04	1/4	1/4	.939	.472	1.594	1.063	.748
GSCO 05-02	5/16	1/8	.781	.315	1.441	1.004	.551
GSCO 05-04	5/16	1/4	.939	.472	1.594	1.083	.748
GSCO 06-04	3/8	1/4	.939	.472	1.594	1.181	.748



NPTF Threads

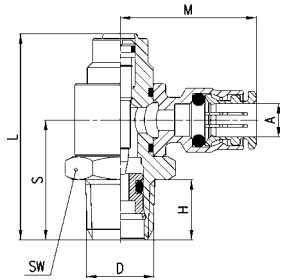

DIMENSIONS								
Model	A	B	S	H	L	M	F	SW
GSCO 813-M5-3	M5	3	12	3	27.5	12.5	6.5	8
GSCO 814-M5-4	M5	4	12	3	27.5	19	8.8	8
GSCO 803-1/8-6	G1/8	6	22.5	5	50	26.5	13	14
GSCO 804-1/8-8	G1/8	8	22.5	5	50	28	15	14
GSCO 805-1/4-8	G1/4	8	27	7	67.5	28.5	15	19
GSCO 806-1/4-10	G1/4	10	27	7	67.5	31	17.5	19



BSP Threads

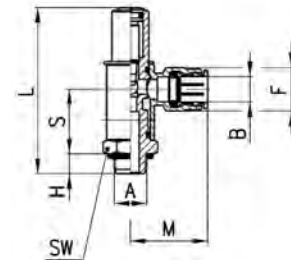

Needle Orifice Valves Series GSCO

This needle-orifice bidirectional flow control is designed with a needle orifice. It has a screwdriver adjustment with right-angle female threads.



DIMENSIONS (in inches)							
Part No.	A NPTF	D NPTF	H	S	L	M	SW
GSCO 02F-02	1/8	1/8	0.315	0.768	1.449	0.787	0.551
GSCO 04F-04	1/4	1/4	0.472	0.925	1.614	1.004	0.748



NPTF Threads

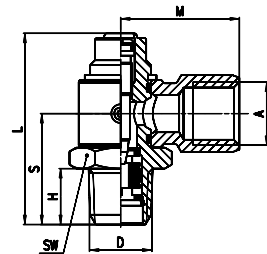

Needle Orifice Valves Series GMCO

This needle-orifice bidirectional flow control is designed with a needle orifice. It has a manual adjustment with a right-angle push to connect tube fitting.



DIMENSIONS									
Model	A OD	D NPTF	S	H	L	Z	M	SW	SW1
GMCO 02-02	1/8	1/8	.781	.175	1.775	2.011	.846	.551	.275
GMCO 53-02	5/32	1/8	.781	.315	1.775	2.011	.885	.551	.275
GMCO 04-02	1/4	1/8	.781	.315	1.775	2.011	.984	.551	.275
GMCO 05-02	5/16	1/8	.781	.315	1.775	2.011	1.004	.551	.275

DIMENSIONS										
Model	A	B	S	H	L	Z	M	F	SW	SW1
GMCO 913-M5-3	M5	3	12	3	37	42.5	12.5	6.5	8	5.5
GMCO 914-M5-4	M5	4	12	3	37	42.5	19	8.8	8	5.5
GMCO 903-1/8-6	G1/8	6	22.5	5	65.5	72.5	26.5	13	14	7
GMCO 904-1/8-8	G1/8	8	22.5	5	65.5	72.5	28	15	14	7
GMCO 905-1/4-8	G1/4	8	27	7	85	97.5	28.5	15	19	10
GMCO 906-1/4-10	G1/4	10	27	7	85	97.5	31	17.5	19	10

NPTF Threads

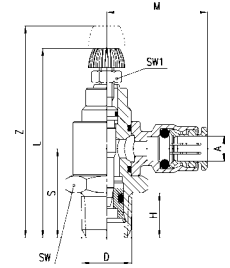

BSP Threads

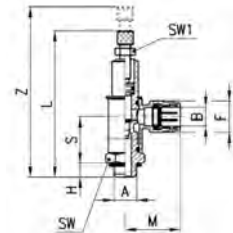

Needle Orifice Valves Series GMCO Female Threaded

This needle-orifice bidirectional flow control is designed with a needle orifice. It has a manual adjustment with right-angle female threads.



DIMENSIONS (in inches)									
Model	A NPTF	D NPTF	H	S	L	Z	M	SW	SW1
GMCO 02F-02	1/8	1/8	0.315	0.768	2.031	1.815	0.787	0.551	0.276



NPTF Threads

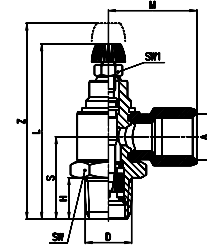

Exhausting Flow Controls Model GMCU 2905

Meter-out unidirectional exhaust controller for mounting cylinders or valves. It has a manual adjustment with a sintered bronze banjo silencer.

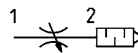

DIMENSIONS (in inches)								
Model	D NPTF	G	H	S	L	Z	SW	SW
GMCU 2905-02	1/8	0.551	0.315	0.768	2.031	1.815	0.551	0.276
GMCU 2905-04	1/4	0.709	0.472	0.925	2.224	1.992	0.748	0.276
GMCU 2905-06	3/8	0.827	0.472	0.945	2.610	2.291	0.866	0.394

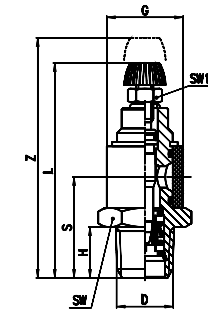

Exhausting Flow Controls Model GSCU 2905

Meter-out unidirectional exhaust controller for mounting cylinders or valves. It has a screwdriver adjustment with a sintered bronze banjo silencer.

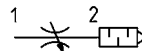

DIMENSIONS (in inches)						
Model	D NPTF	G	H	S	L	SW
GSCU 2905-02	1/8	0.551	0.315	0.768	1.449	0.551
GSCU 2905-04	1/4	0.709	0.472	0.925	1.614	0.748
GSCU 2905-06	3/8	0.827	0.472	0.945	1.803	0.866

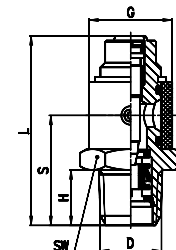

Non-Swivel Banjo-Style Nickel-Plated Brass Flow Control Valves and Bodies Series SCU, MCU, SVU, MVU, SCO, MCO

Non-Swivel Design : Meter-Out, Meter-In and Needle Orifice
 Tube Diameter OD: 4mm, 5mm, 6mm, 8mm, 10mm, 12mm (banjo fittings required)
 thread adapters required for NPTF
 Thread Type: Inch 10/32 (UNF), NPTF 1/8", 1/4", 3/8"
 Metric (M5), BSP (G1/8, G1/4, G3/8, G1/2), thread adapters required for BSPT/R



These unidirectional and bidirectional flow controllers have been designed as small as possible so as to be mounted directly on valves or cylinders. The great variety of adjustable fittings makes it possible to complete the regulator with the most suitable system in relation to the available tube.

Only the G1/2 model is supplied complete with banjo flow controllers. For the other models the banjo and flow controller are to be requested separately.

GENERAL DATA

Construction	needle type
Valve group	unidirectional and bidirectional controller
Materials	body and regulation screw: M5 = stainless steel; 1/8 - 1/4 - 3/8 - 1/2 = Nickel-plated brass body, plain brass adjustment screw seals = NBR (Buna-N)
Mounting	by male thread
Ports	M5 - G1/8 - G1/4 - G3/8 - G1/2
Installation	in any position
Operating temperature	0°C - 80°C (with dry air - 20°C) (32° - 175° F, dry air necessary down to -4° F)
Operating pressure	1 - 10 bar (14.5 - 145 psi)
Nominal pressure	6 bar (87 psi)
Nominal flow	see graph
Nominal diameter (flow orifice)	M5 = 1,5 mm - G1/8 = 2 mm - G1/4 = 4 mm - G3/8 = 7 mm - G1/2 = 12 mm
Fluid	filtered air

Nickel-Plated Brass Flow-Control Valves:

4



Features

- All-Metal, Nickel-Plated body and Threads,
- Compact Brass bodies from Brass forgings
- Specialized O-ring choices for High-Temp, Low-Temp, Special Fluids, Food-Grade compatibility
- Multiple Thread sealant systems: BSPP & BSPT, or O-Ring Spot Face seals
- Broad Range of configurations, tube-thread combinations
- Removable Collet and tube o-rings
- Highly accurate Flow-rate repeatability & Higher Flow
- Manual Adjustment knob or Screw-Driver slot
- Hex Locking-nut
- Precise Manual knob, with Internal hex-key
- Full Swivel design, NPTF and Metric/BSP, with integrated Push-In Fittings or Female thread ports
- Alternate Non-Swivel design with Banjo Tube connections and thread adapters
- Meter-IN, Meter-OUT and Needle-Orifice flow designs for assembly on valves, cylinders or in-line use
- Alternate sintered bronze banjo for fully adjustable silencer/muffler with speed control for exhaust port mounting, (see Part No. 2905 to add to any banjo flow control body)

Benefits

Collet

- Won't break like plastic release rings and bodies; More Durable design
- Higher holding force, with easier release
- Won't scratch tubes like "bite-ring" designs
- Less chance of micro-leakage and bubble-leaks over time due to damaged tubing

Body

- Resistant to UV exposure
- Better resistance to stress-cracking, abrasion, solvents, detergents, hydrocarbons and other fluid media
- FDA/NSF approved materials, (Including customized Nickel-Plating and o-ring options)
- Simplified manifold circuits with broader variety of fitting combinations and shapes to select
- Lighter weight for End-of-Arm tooling & Robotic handling,
- Compact design reduces overall dimensions for valve & cylinder assemblies, packaging applications and control cabinets

Design

- Accuracy and Repeatability of Flow-Control valves allows timing circuits to be design, faster OEM set-up and simplified MRO field installation and replacements
- Simplified manifold circuits with broader variety of Tube - Thread combinations to select
- Lighter weight for End-of-Arm tooling & Robotic handling
- Compact design reduces overall dimensions for valve assemblies, packaging applications and control cabinets
- More compact flow capacity reduces cylinder spacing with improved overall speed
- Fine tuning of flow with manual knob or screw-driver adjustment
- Convertible into "Tamper-Proof" by removing manual knob or sealing screw-driver slot
- Interchangeable Inch and Metric Tube O.D. banjo connections and thread adapters for "hybrid" Fittings and Flow-control valve requirements

INCH/NPT CODING EXAMPLE

M	CU	32F	-	32
----------	-----------	------------	----------	-----------

M	ACTUATION: M = Manual S = Screwdriver
CU	ASSEMBLY: CU = on cylinders unidirectional (meter-out) VU = on valves unidirectional (meter-in) CO = bidirectional (needle-orifice)
32	Banjo Port Size: 02 = 1/8" Push-in Tube 04 = 1/4" Push-in Tube 06 = 3/8" Push-in Tube 08 = 1/2" Push-in Tube 32F = 10/32 UNF 02F = 1/8 NPTF 04F = 1/4 NPTF 06F = 3/8 NPTF 08F = 1/2 NPTF
32	PORTS: 32 = 10/32 UNF 02 = 1/8 NPTF 04 = 1/4 NPTF 06 = 3/8 NPTF 08 = 1/2 NPTF

To ensure the right choice of unidirectional flow controller, proceed as follows: calculate the quantity of air in NL/min (see cylinder Table); determine the stroke time of the cylinder; refer to graph to see which controller is the right type.

BSP/METRIC CODING EXAMPLE

M	CU	7	02	-	M5
----------	-----------	----------	-----------	----------	-----------

M	ACTUATION: M = Manual S = Screwdriver
CU	ASSEMBLY: CU = on cylinders unidirectional (meter-out) VU = on valves unidirectional (meter-in) CO = bidirectional (needle-orifice)
7	VERSIONS: 6 = needle (screwdriver operated) 7 = needle (manual operated)
02	NOMINAL DIAMETER (flow orifice): 02 = ø 1.5 max 04 = ø 2 max 06 = ø 4 max 08 = ø 7 max 10 = ø 12 max
M5	PORTS: M5 = M5 1/8 = G1/8 1/4 = G1/4 3/8 = G3/8 1/2 = G1/2

To ensure the right choice of unidirectional flow controller, proceed as follows: calculate the quantity of air in NL/min (see cylinder Table); determine the stroke time of the cylinder; refer to graph to see which controller is the right type.

Banjo-Style Flow Control Valve Assembly

4

BSP Non-Swivel models and customized NPTF models not shown in catalog, or hybrids

1. Older style flow-control valves with banjo tube/thread connections and stud valve types may be assembled in a variety of combinations.
2. Select any stud valve flow-control type; Meter-In, Meter-Out, or Needle -Orifice with either Manual or Screwdriver adjustment, (i.e. MCU-, SCU-, MVU-, SVU-, MCO-, SCO- from BSP flow control body offering).
3. Select desired banjo connection, either inch OD, metric/mm OD, metric compression, female thread or silencer ring from banjo offerings in Fittings section of catalog , (i.e. 6610 04-02, 6610 6-1/8, 2023 02-02, 2023 ¼-1/4, 1610 6/4-1/8, 2905 ¼, etc.)
4. Select thread adapter to "close" the final assembly and hold banjo in place, (i.e. 2520 02-1/8, 2520 04-1/4, 2520 ¼-1/4, 2520 1/8-1/8), depending on final thread choice of BSP or NPTF threads.

FLOW CONTROL VALVES

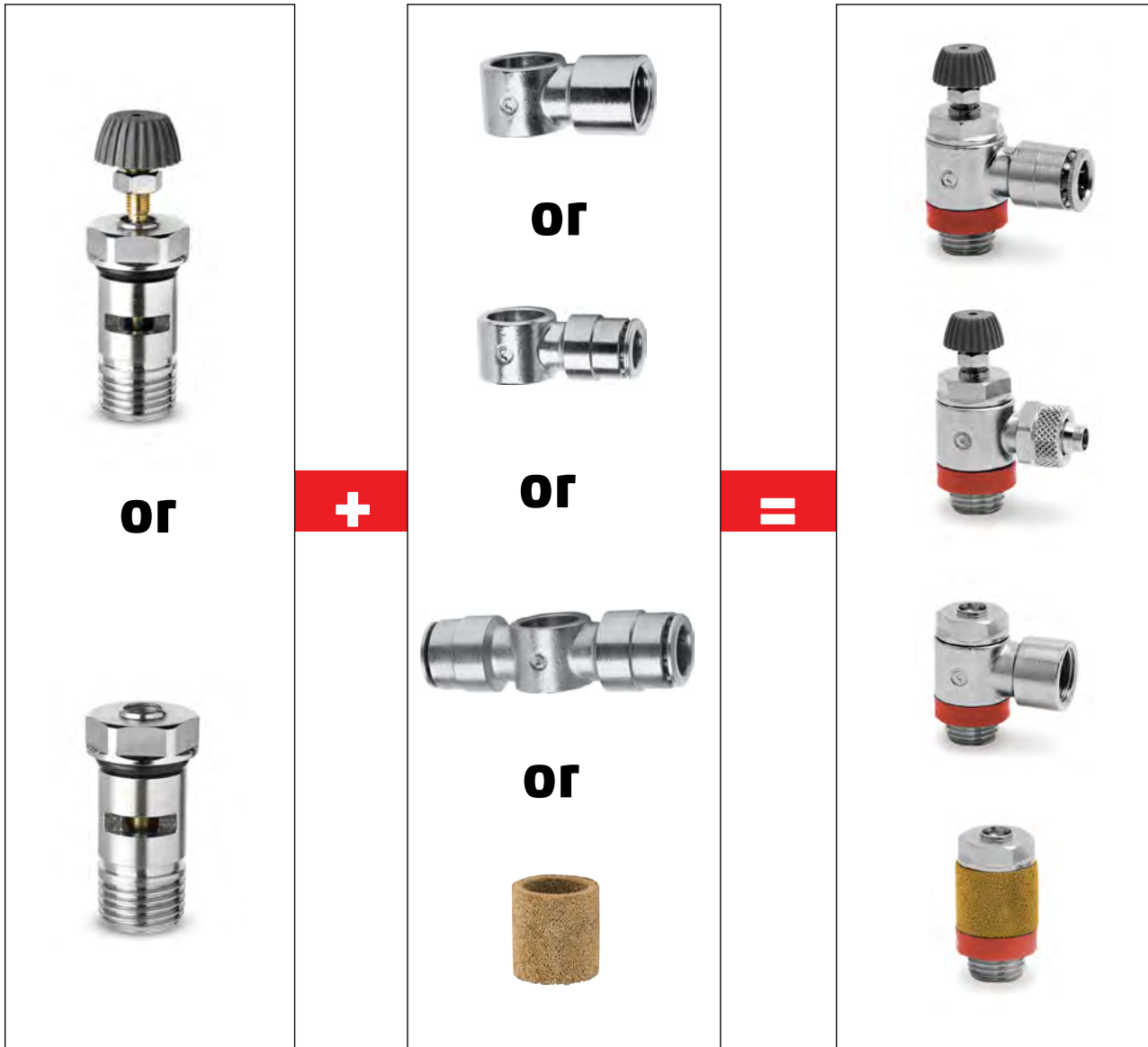

METER IN, METER OUT, NEEDLE ORIFICE FLOW CONTROLLERS

4

FLOW CONTROL VALVES

M5

Flow Qn (NL/min.) from 2 → 1 with controller OPEN: 70
 Flow Qn (NL/min.) from 2 → 1 with controller CLOSED: 33
 Qn = supply pressure of 6 bar and with ΔP = 1 bar at the outlet
 N° = number of screw turns.

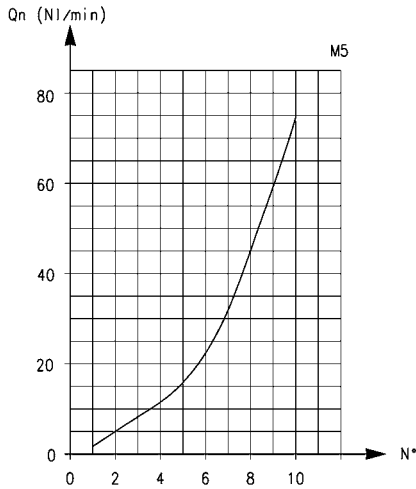

G 1/8

Flow Qn (NL/min.) from 2 → 1 with controller OPEN: 200
 Flow Qn (NL/min.) from 2 → 1 with controller CLOSED: 70

Qn = supply pressure of 6 bar and with ΔP = 1 bar at the outlet
 N° = number of screw turns.

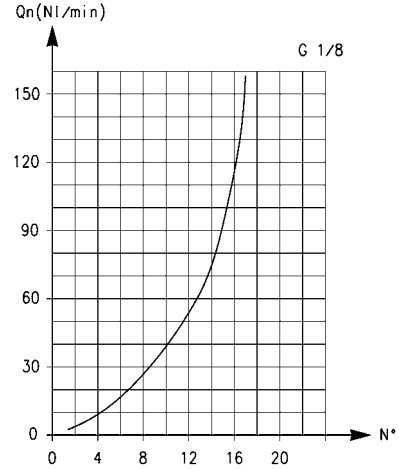

G 1/4

Flow Qn (NL/min.) from 2 → 1 with controller OPEN: 530
 Flow Qn (NL/min.) from 2 → 1 with controller CLOSED: 160

Qn = supply pressure of 6 bar and with ΔP = 1 bar at the outlet
 N° = number of screw turns.

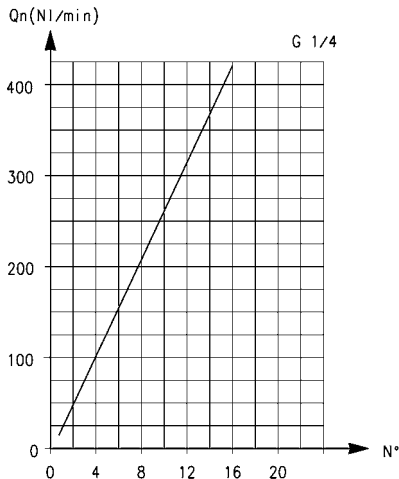

G 3/8

Flow Qn (NL/min.) from 2 → 1 with controller OPEN: 710
 Flow Qn (NL/min.) from 2 → 1 with controller CLOSED: 410

Qn = supply pressure of 6 bar and with ΔP = 1 bar at the outlet
 N° = number of screw turns.

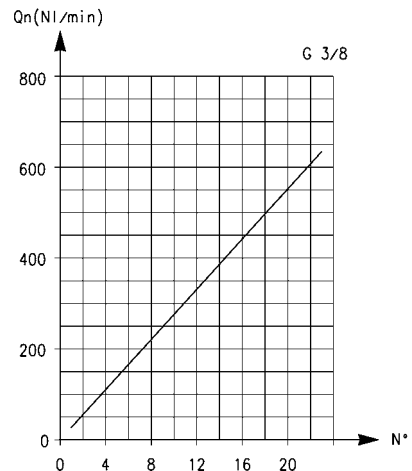

METER IN, METER OUT, NEEDLE ORIFICE FLOW CONTROLLERS

4

G 1/2

Flow Q_n (NL/min.) from 2 → 1 with controller OPEN: 2570
 Flow Q_n (NL/min.) from 2 → 1 with controller CLOSED: 1330

Q_n = supply pressure of 6 bar and with ΔP = 1 bar at the outlet
 N° = number of screw turns.

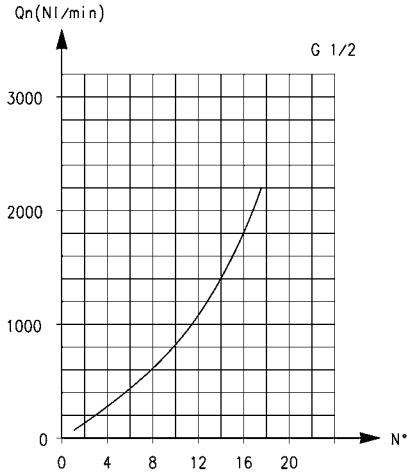

FLOW CONTROL IDENTIFICATION

VALVE BODY IDENTIFICATION:

SCU - MCU = assembly directly on the cylinders
 SVU - MVU = assembly directly on the valves
 SCO - MCO = assembly directly on the cylinders or valves

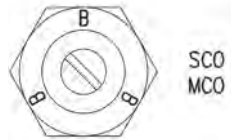
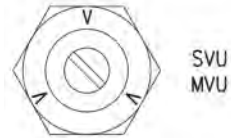
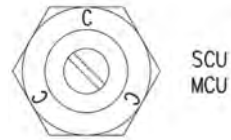

FLOW CONTROL VALVES

Unidirectional flow controllers Series SCU

For mounting on single-acting or double-acting cylinders.
Adjustment of setting by a screwdriver.
Ports: M5, G1/8, G1/4 and G3/8.

Assembly with fittings Model 6610; 6620; 1610; 1620; 2023; 1170.

DIMENSIONS (in mm)

Model	A	H	L	S	SW
SCU 602-M5	M5	3.5	21.5	5.5	8
SCU 604-1/8	G1/8	5	31.5	12.5	12
SCU 606-1/4	G1/4	6	32.5	12.5	15
SCU 608-3/8	G3/8	7	40.5	12.5	18

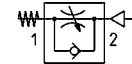
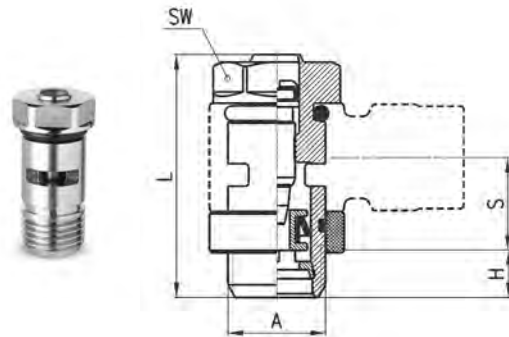

Note: M5 flow controllers must be used together with M6 banjo fittings.

Unidirectional flow controllers Series MCU

For mounting on single-acting or double-acting cylinders.
Adjustment of setting by a manually operated knurled screw.
Ports: M5, G1/8, G1/4, G3/8.

Assembly with fittings Model 6610; 6620; 1610; 1620; 2023; 1170.

DIMENSIONS (in mm)

Model	A	H	L	S	SW	SW1	Z
MCU 702-M5	M5	3.5	31	5.5	8	5.5	35
MCU 704-1/8	G1/8	5	41	12.5	12	7	46
MCU 706-1/4	G1/4	6	43.5	12.5	15	7	49
MCU 708-3/8	G3/8	7	52.5	12.5	18	10	60.5

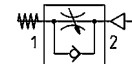
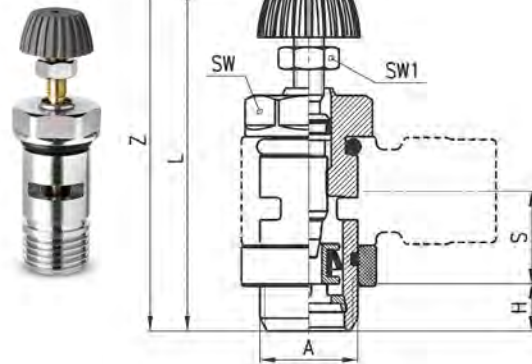

Note: M5 flow controllers must be used together with M6 banjo fittings.

Unidirectional flow controllers Series SVU

For mounting on valves.
Adjustment of setting by a screwdriver.
Ports: M5, G1/8, G1/4.

Assembly with fittings Model 6610; 6620; 1610; 1620; 2023; 1170.

DIMENSIONS (in mm)

Model	A	H	L	S	SW
SVU 602-M5	M5	3.5	21.5	5.5	8
SVU 604-1/8	G1/8	5	31.5	12.5	12
SVU 606-1/4	G1/4	6	32.5	12.5	15

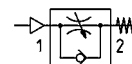
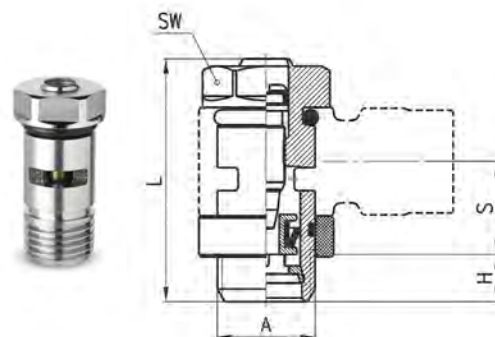

Note: M5 flow controllers must be used together with M6 banjo fittings.

Unidirectional flow controllers Series MVU

For mounting on valve. Adjustment of setting by a manually operated knurled screw.
Ports: M5, G1/8, G1/4.

Assembly with fittings Model 6610; 6620; 1610; 1620; 2023; 1170.

DIMENSIONS (in mm)

Model	A	H	L	S	SW	SW1	Z
MVU 702-M5	M5	3.5	31	5.5	8	5.5	35
MVU 704-1/8	G1/8	5	41	12.5	12	7	46
MVU 706-1/4	G1/4	6	43.5	12.5	15	7	49

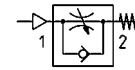
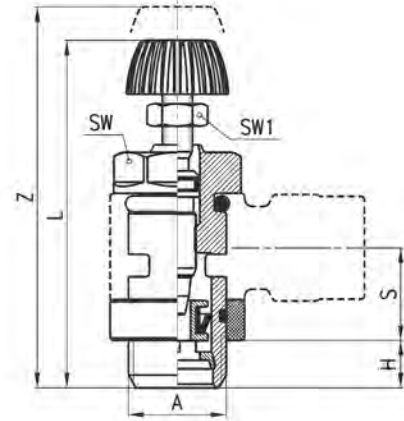

Note: M5 flow controllers must be used together with M6 banjo fittings.

Bidirectional flow controllers Series SCO

Adjustment of setting by a screwdriver.
Ports: M5, G1/8, G1/4.

Assembly with fittings Model 6610; 6620; 1610; 1620; 2023; 1170; 2905.

DIMENSIONS (in mm)

Model	A	H	L	S	SW
SCO 602-M5	M5	3.5	21.5	5.5	8
SCO 604-1/8	G1/8	5	31.5	12.5	12
SCO 606-1/4	G1/4	6	32.5	12.5	15

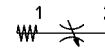
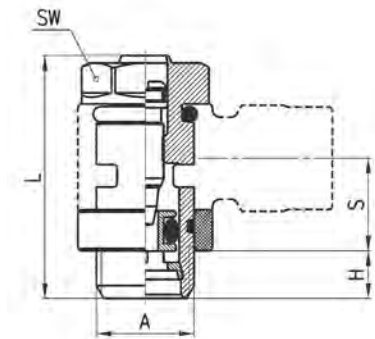

Note: M5 flow controllers must be used together with M6 banjo fittings.

Bidirectional flow controllers Series MCO

Adjustment of setting by a manually operated knurled screw.
Ports: M5, G1/8, G1/4.

Assembly with fittings Model 6610; 6620; 1610; 1620; 2023; 1170; 2905.

DIMENSIONS (in mm)

Model	A	H	L	S	SW	SW1	Z
MCO 702-M5	M5	3.5	31	5.5	8	5.5	35
MCO 704-1/8	G1/8	5	41	12.5	12	7	46
MCO 706-1/4	G1/4	6	43.5	12.5	15	7	49

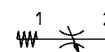
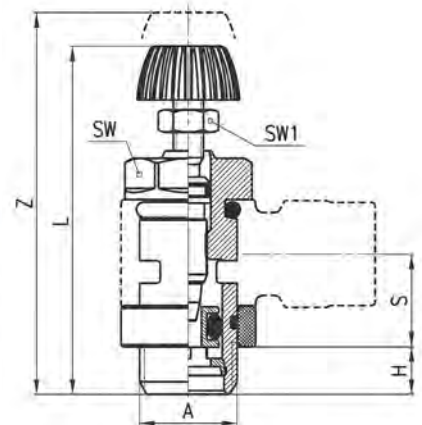

Note: M5 flow controllers must be used together with M6 banjo fittings.

Fittings Model 6610 assembled with Model 1631, 1635

Single Banjo

INCH Tube Fittings

DIMENSIONS (in inches)

Model	A OD	V	C	F	M	O	V	W
6610 53-32	5/32	10-32	0.197	0.346	0.748	0.354	0.197	0.346
6610 02-02	1/8	1/8	0.295	0.354	0.846	0.571	0.382	0.551
6610 53-02	5/32	1/8	0.335	0.394	0.886	0.571	0.382	0.551
6610 04-02	1/4	1/8	0.327	0.500	0.965	0.571	0.382	0.551
6610 04-04	1/4	1/4	0.406	0.500	1.043	0.571	0.516	0.709
6610 06-04	3/8	1/4	0.354	0.650	1.142	0.571	0.516	0.709
6610 06-06	3/8	3/8	0.413	0.650	1.201	0.571	0.657	0.827

METRIC Tube Fittings

DIMENSIONS (in mm)

Model	A	C	F	M	O	V	W	Weight (g)
6610 4-M5	4	5	9	19	9	5.1	Ø 9	9
6610 4-M6	4	5	9	19	9	5.1	Ø 9	8
6610 4-1/8	4	7.5	9	21.5	14.5	9.8	Ø 14	14
6610 5-M5	5	5	10	20	9	5.1	Ø 9	9
6610 5-M6	5	5	10	20	9	5.1	Ø 9	8
6610 5-1/8	5	8	10	23	14.5	9.8	Ø 14	16
6610 6-M5	6	6.5	12.7	22.5	9	5.1	Ø 10	12
6610 6-M6	6	6.5	12.7	22.5	9	5.1	Ø 10	12
6610 6-1/8	6	8	12.7	24	14.5	9.8	Ø 14	16
6610 6-1/4	6	10	12.7	26	14.5	13.2	Ø 18	19
6610 8-1/8	8	8	14.2	25.5	14.5	9.8	Ø 14	19
6610 8-1/4	8	10	14.2	27.5	14.5	13.2	Ø 18	22
6610 8-3/8	8	11	14.2	28.5	14.5	16.7	Ø 21	23
6610 10-1/4	10	8.8	16.5	29	14.5	13.2	Ø 18	22 *
6610 10-3/8	10	10.3	16.5	30.5	14.5	16.7	Ø 21	23 *
6610 12-1/2	12	12.8	16.5	32	14.5	21	Ø 26	37 *

INCH Tube Fittings

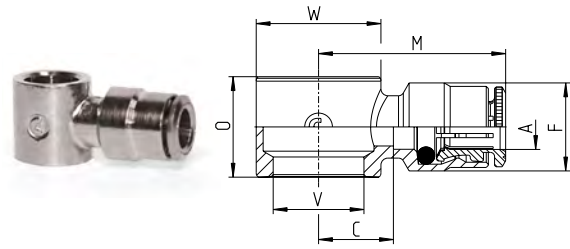

METRIC Tube Fittings

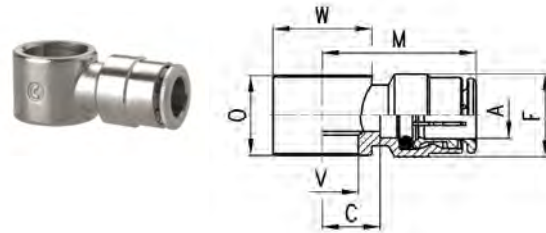

= assembly required with Model SCU, SVU, SCO... M5 only
* = they cannot be assembled with Model 1631, use 1635 instead

Fittings Model 2023 assembled with Model 1631, 1635

Single Thread Banjo

NPTF THREADS

DIMENSIONS (in inches)

Model	B	V	O	M	W
UNF					
2023 32-32	10-32	10-32	.354	.413	.346
NPTF					
2023 02-02	1/8	1/8	.571	.787	.551
2023 04-04	1/4	1/4	.571	1.004	.709
2023 06-06	3/8	3/8	.571	1.102	.827

BSP THREADS

DIMENSIONS (in mm)

Model	B	M	O	V	W	Weight (g)
2023 M5-M5	M5	10.5	9	5.1	9	6
2023 M5-M6	M5	10.5	9	5.1	9	6
2023 1/8-1/8	G1/8	20	14.5	9.8	Ø 14	14
2023 1/4-1/4	G1/4	23.5	14.5	13.2	Ø 18	21
2023 3/8-3/8	G3/8	26.5	14.5	16.7	Ø 21	27

NPT THREADS

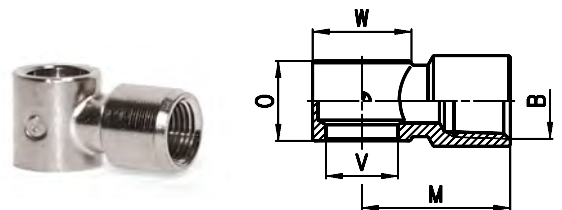

BSP THREADS

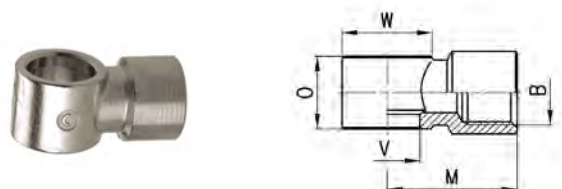

= assembly with Model SCU, SCO, SVU... M5
= assembly with Model 1635

Fittings Model 2520
BSPT Male Reducing Extension

BSP THREADS

DIMENSIONS (in mm)

Model	A	B	H	L	SW	Weight (g)
2520 1/8-1/8	R1/8	G1/8	7.5	17.5	13	9
2520 1/8-1/4	R1/8	G1/4	7.5	19	17	15
2520 1/8-3/8	R1/8	G3/8	7.5	20	20	19
2520 1/4-1/4	R1/4	G1/4	11	22.5	17	17
2520 1/4-3/8	R1/4	G3/8	11	23.5	20	21
2520 1/4-1/2	R1/4	G1/2	11	27.5	24	35
2520 3/8-3/8	R3/8	G3/8	11.5	24	20	23
2520 3/8-1/2	R3/8	G1/2	11.5	28	24	37
2520 1/2-1/2	R1/2	G1/2	14	30.5	24	41



BSP THREADS

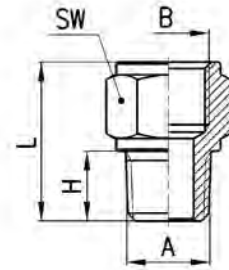

Fittings Model 2520...
Adapter BSPP Female – NPTF Male

NPTF / BSP THREADS

DIMENSIONS (in inches)

Model	Thread		H	L	SW
	A	B			
	UNF	METRIC			
2520 32-M5	10-32	M5	.177	.472	.315
	NPTF	BSP			
2520 02-1/8	1/8	1/8	.315	.708	.512
2520 04-1/4	1/4	1/4	.472	.925	.669
2520 06-3/8	3/8	3/8	.472	.964	.787
2520 08-1/2	1/2	1/2	.551	1.200	.945



NPTF / BSP Threads

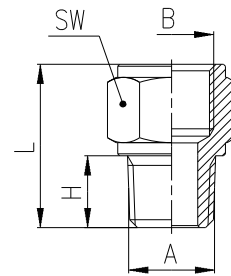

Silencing bush Series 2905
For flow control valves Model SCO and MCO

DIMENSIONS (in mm)

Model	A	B	L
2905 1/8	14	10	14.5
2905 1/4	18	13.5	14.5
2905 3/8	21	16.8	14.5

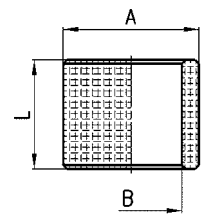

Exhausting Flow Controls Model SCO + 2905
The flow control valve Model SCO and the silencer Model 2905 are supplied separately.

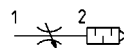

BSP THREADS

DIMENSIONS (in mm)

Model	A	H	L	S	SW
SCO 602-M5+2905 M5	M5	3.5	21.5	5.5	8
SCO 604-1/8+2905 1/8	G1/8	5	31.5	12.5	12
SCO 606-1/4+2905 1/4	G1/4	6	32.5	12.5	15



BSP THREADS

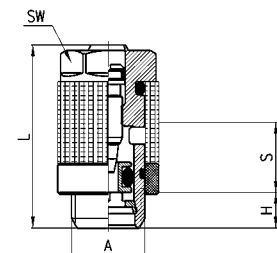

Swivel Composite Right Angle Flow Control Valves Series TMCU, TMVU, TMCO

Swivel Design : Meter-Out, Meter-In and Needle Orifice

Tube Diameter OD: 4mm, 6mm, 8mm, 10mm

5/32", 1/4", 5/16", 3/8"

Thread Type: BSP G1/8, G1/4, G3/8, G1/2 with Spot-Face O-ring Seal

NPTF 1/8", 1/4", 3/8", 1/2" with Pro-Fit® (Reusable PTFE/Teflon Seal)



Series TMCU, TMVU, TMCO unidirectional and bidirectional flow controllers have been revised in order to decrease their dimensions and improve their flow rate characteristics. Their construction allows for easy assembly to cylinders and valves and allows the regulation adjustment to be precise and gradual.

Pro-Fit®/Sprint® Torque Specifications

Thread Size	Minimum Torque		Maximum Torque	
	N-m	lb-ft	N-m	lb-ft
M5 [10-32 UNF]	0.200	0.148	2.000	1.475
1/8 NPTF or BSP	1.000	0.738	10.000	7.376
1/4 NPTF or BSP	4.000	2.950	20.000	14.751
3/8 NPTF or BSP	5.000	3.688	20.000	14.751
1/2 NPTF or BSP	8.000	5.900	40.000	29.502

GENERAL DATA

Construction	needle - type
Valve group	Meter In, Meter Out, Needle Orifice flow controller
Materials	OT58 Nickel Plated Brass Threads and Collet - Technopolymer (Glass-Reinforced Nylon® 66 Resin) - BUNA-N Seals, PTFE thread seal
Mounting	by male thread
Threaded ports	NPTF 1/8", 1/4", 3/8", 1/2" BSP G1/8 - G1/4 - G3/8 - G1/2
Installation	in any position (spot face o-ring thread seal)
Operating temperature	0 - 60°C (with dry air -20°C) (32°F - 140°F, with dry air -4°F)
Operating pressure	0.5 - 10 bar (7.25 - 145 psi)
Nominal pressure	6 bar (87 psi)
Nominal flow	see graph
Nominal dia. (flow orifice)	Tube OD: 5/32" - 2mm, 1/4" - 3.8mm, 5/16" - 5.8mm, 3/8" & 1/2" - 8mm 4 Ø2 mm (.079") - Tube 6 Ø3.8 mm (.150") - Tube 8 Ø5.8 mm (.228") - Tube 10 and 12 Ø8 mm (.315")
Fluid	filtered air If lubricated air is used, it is recommended to use ISOVG 32 oil. Once applied the lubrication should never be interrupted.

Composite Flow Control Valves:

BSP Threads with Spot-Face O-Ring Seals

NPTF Threads with *Pro-Fit*[®] Teflon[®] Seals

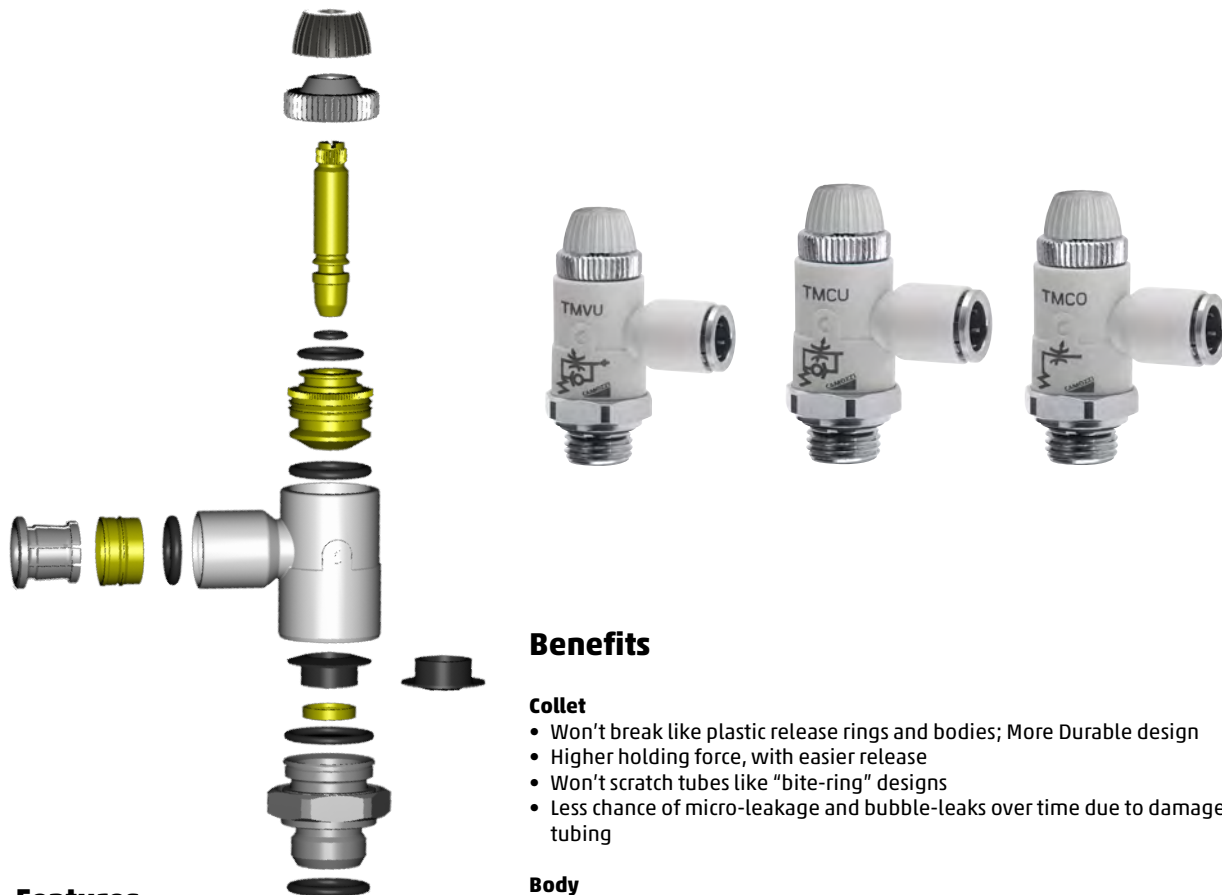

Features

- All metal, Nickel-Plated collet and threads
- Strong, specialized Nylon[®] compound body material
- Specialized O-ring choices for High-Temp, Low-Temp, Special Fluids, Food-Grade compatibility
- Multiple Thread sealant systems: O-Ring Spot Face seals effectively on BSPP, BSPT or JIS (Rpt or Rc , G or Rg) thread ports
- Broad Range of Tube / Thread combinations
- Removable Collet and tube o-rings
- Highly accurate Flow-rate repeatability & Higher Flow than typical brass bodied flow control valves
- Large ¼-Turn Locking-nut
- Precise Manual knob, w/ Internal hex-key
- Full Swivel design, NPTF and Metric/BSP, with integrated Push-In Fittings
- Meter-IN, Meter-OUT and Needle-Orifice flow designs for assembly on valves, cylinders or in-line use
- ANSI symbol stamped on all bodies
- Tube O.D. size stamped on all collet faces
- Meter-IN, Meter-OUT and Needle-Orifice flow designs for assembly on valves, cylinders or in-line use

Benefits

Collet

- Won't break like plastic release rings and bodies; More Durable design
- Higher holding force, with easier release
- Won't scratch tubes like "bite-ring" designs
- Less chance of micro-leakage and bubble-leaks over time due to damaged tubing

Body

- Resistant to UV exposure
- Better resistance to stress-cracking, abrasion, solvents, detergents, hydrocarbons and other fluid media
- FDA/NSF approved materials, (Including customized Nickel-Plating and o-ring options)
- Simplified manifold circuits with broader variety of fitting combinations and shapes to select
- Lighter weight for End-of-Arm tooling & Robotic handling,
- Compact design reduces overall dimensions for valve & cylinder assemblies, packaging applications and control cabinets
- 10% Reduction in Flow-Control size over previous brass bodies

Design

- Accuracy and Repeatability of Flow-Control valves allows timing circuits to be design, faster OEM set-up and simplified MRO field installation and replacements
- Simplified manifold circuits with broader variety of Tube - Thread combinations to select
- Lighter weight for End-of-Arm tooling & Robotic handling
- Compact design reduces overall dimensions for valve assemblies, packaging applications and control cabinets
- More compact flow capacity reduces cylinder spacing with improved overall speed
- Fine tuning of flow with manual knob or hex-key adjustment
- Convertible into "Tamper-Proof" by removing manual knob and sealing hex-key slot
- Interchangeable Inch and Metric Thread adapters for "hybrid" Fittings and Flow-control valve requirements. (*Pro-Fit*[®] NPTF threads and BSP Spot-Face o-ring seals in opposite port standards)

INCH / NPT CODING EXAMPLE

TM	CU	04	-	02
-----------	-----------	-----------	----------	-----------

TM	ACTUATION: TM = manual, composite swivel body
CU	ASSEMBLY: CU = on cylinders unidirectional, meter out VU = on valves unidirectional, meter in CO = bidirectional, needle orifice
04	Tube OD Connection: 53 = 5/32" OD 04 = 1/4" OD 05 = 5/16" OD 06 = 3/8" OD 08 = 1/2" OD
02	Thread PORTS: 02 = 1/8" NPTF 04 = 1/4" NPTF 06 = 3/8" NPTF 08 = 1/2" NPTF

To ensure the right choice of unidirectional flow controller, proceed as follows: calculate the quantity of air in NI/min (see cylinder Table); determine the stroke time of the cylinder; refer to graph to see which controller is the right type.

METRIC / BSP CODING EXAMPLE

TM	CU	9	74	-	1/8	-	6
-----------	-----------	----------	-----------	----------	------------	----------	----------

TM	ACTUATION: TM = manual, swivel body
CU	ASSEMBLY: CU = on cylinders unidirectional, meter out VU = on valves unidirectional, meter in CO = bidirectional, needle orifice
9	VERSIONS: 9 = manual needle
74	REGULATION: Orifice - Ø tube 72 = 2 mm 4 mm 74 = 3.8 mm 6 mm 76 = 5.8 mm 8 mm 78 = 8 mm 10 mm
1/8	PORTS: 1/8 BSPP 1/4 BSPP 3/8 BSPP 1/2 BSPP
6	Ø TUBE: 4 mm 6 mm 8 mm 10 mm

To ensure the right choice of unidirectional flow controller, proceed as follows: calculate the quantity of air in NI/min (see cylinder Table); determine the stroke time of the cylinder; refer to graph to see which controller is the right type.

METER IN, METER OUT, NEEDLE ORIFICE FLOW CONTROLLERS

To ensure the right choice of unidirectional flow controller, proceed as follows: calculate the quantity of air in NL/min (see cylinder Table); determine the stroke time of the cylinder; refer to graph to see which controller is the right type.

In the case of bi-directional regulators, refer to the graph and check whether the flow control range is suitable for the work required.

INCH / NPTF

TUBE OD 5/32"

Flow Qn (NL/min.) from 2 → 1 with needle OPEN: 400
 Flow Qn (NL/min.) from 2 → 1 with needle CLOSED: 280
 NB: Qn is determined with a supply pressure of 6 bar and with DP= 1 bar at the outlet
 N° = of screw turns

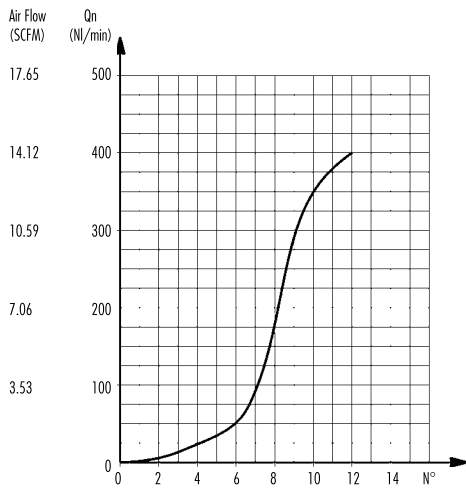

TUBE OD 1/4"

Flow Qn (NL/min.) from 2 → 1 with needle OPEN: 550
 Flow Qn (NL/min.) from 2 → 1 with needle CLOSED: 280
 NB: Qn is determined with a supply pressure of 6 bar and with DP= bar at the outlet
 N° = of screw turns

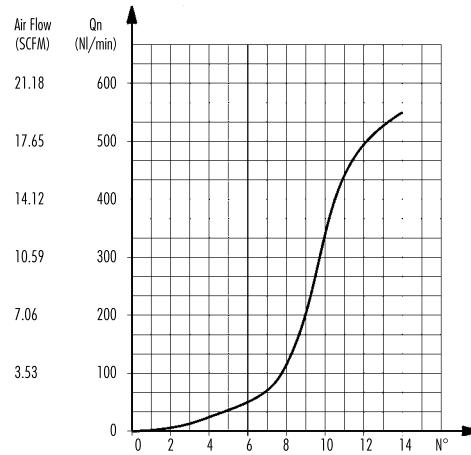

TUBE OD 5/16"

Flow Qn (NL/min.) from 2 * 1 with needle OPEN: 890
 Flow Qn (NL/min.) from 2 * 1 with needle CLOSED: 460
 NB: Qn is determined with a supply pressure of 6 bar and with DP= bar at the outlet
 N° = of screw turns

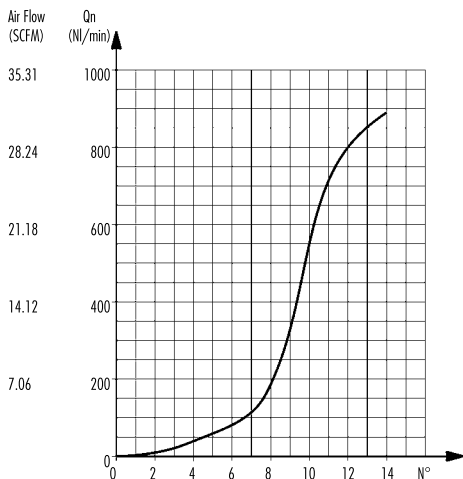

TUBE OD 3/8" - 1/2"

Flow Qn (NL/min.) from 2 * 1 with needle OPEN: Ø 3/8"-1200/
 Ø1/2"-1250
 Flow Qn (NL/min.) from 2 * 1 with needle CLOSED: Ø 3/8"-600/
 Ø1/2"-600
 NB: Qn is determined with a supply pressure of 6 bar and with DP= bar at the outlet
 N° = of screw turns

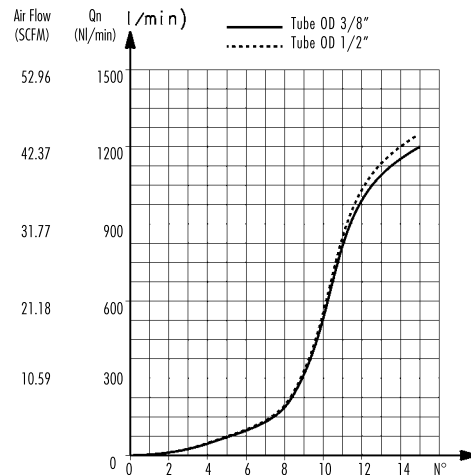

METRIC / BSP

TUBE OD 4mm

Flow Qn (NL/min.) from 2 → 1 with controller OPEN: 400
 Flow Qn (NL/min.) from 2 → 1 with controller CLOSED: 280
 Qn is determined with a supply pressure of 6 bar and with $\Delta P = 1$ bar at the outlet
 N° = number of screw turns.

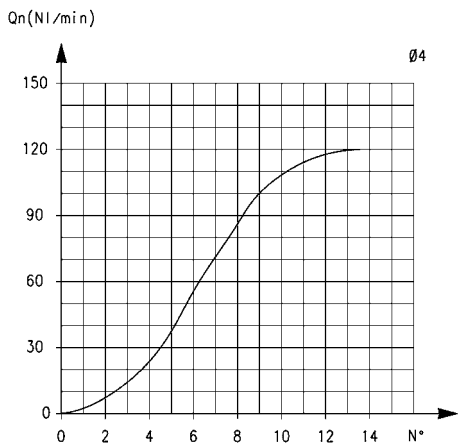

TUBE OD 6mm

Flow Qn (NL/min.) from 2 → 1 with controller OPEN: 550
 Flow Qn (NL/min.) from 2 → 1 with controller CLOSED: 280
 Qn is determined with a supply pressure of 6 bar and with $\Delta P = 1$ bar at the outlet
 N° = number of screw turns.

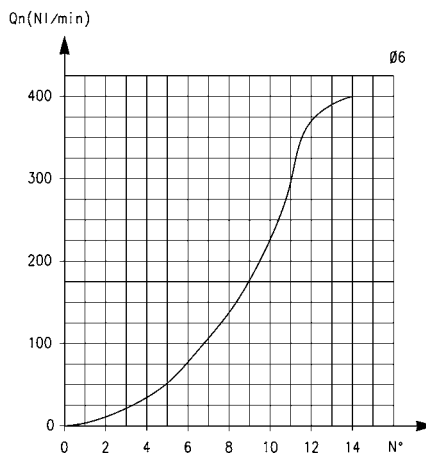

TUBE OD 8mm

Flow Qn (NL/min.) from 2 → 1 with controller OPEN: 890
 Flow Qn (NL/min.) from 2 → 1 with controller CLOSED: 460
 Qn is determined with a supply pressure of 6 bar and with $\Delta P = 1$ bar at the outlet
 N° = number of screw turns.

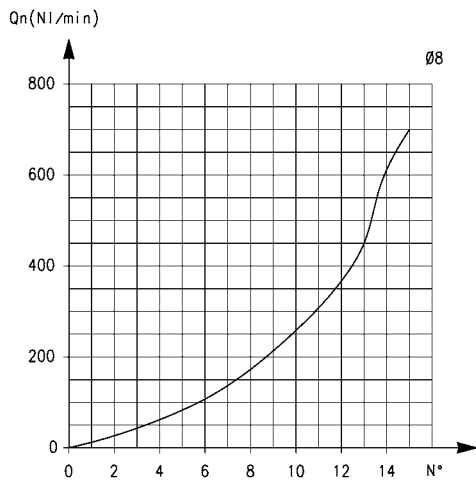

TUBE OD 10mm

Flow Qn (NL/min.) from 2 → 1 with controller OPEN: Ø 10-1200/Ø12-1250
 Flow Qn (NL/min.) from 2 → 1 with controller CLOSED: Ø 10-600/Ø12-600
 Qn is determined with a supply pressure of 6 bar and with $\Delta P = 1$ bar at the outlet
 N° = number of screw turns.

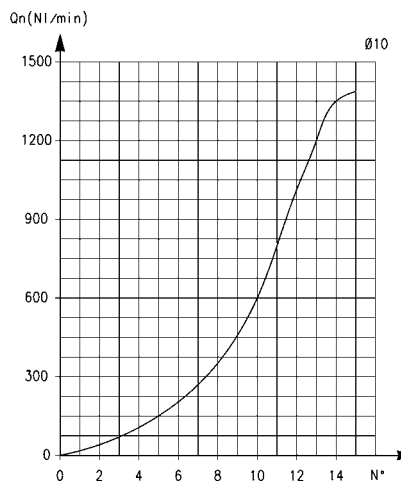

Series TMCU valves

Unidirectional flow controller for mounting on single-acting or double-acting cylinders.
Adjustment of setting by a hexagonal male key or a manually operated knurled screw.
Ports: 1/8", 1/4", 3/8", 1/2" NPTF
G1/8, G1/4, G3/8, G1/2

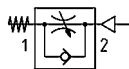

NPTF Threads

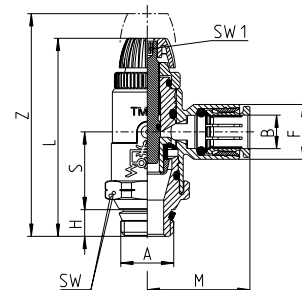

BSP Threads

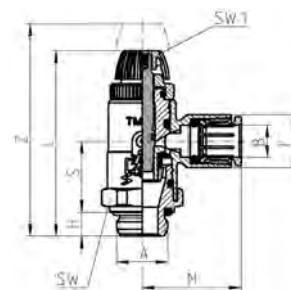

INCH / NPTF										
DIMENSIONS (in inches)										
Model	A	B	F	H	L	M	S	SW	SW1	Z
	NPTF	OD								
TMCU 53-02	1/8	5/32	0.453	0.197	1.654	0.846	0.728	0.630	0.059	1.929
TMCU 04-02	1/8	1/4	0.453	0.197	1.654	0.846	0.728	0.630	0.059	1.929
TMCU 04-04	1/4	1/4	0.453	0.256	1.732	0.846	0.709	0.630	0.059	2.008
TMCU 05-04	1/4	5/16	0.531	0.256	1.890	0.984	0.748	0.748	0.098	2.165
TMCU 05-06	3/8	5/16	0.531	0.295	1.929	0.984	0.748	0.748	0.098	2.205
TMCU 06-04	1/4	3/8	0.630	0.256	1.988	1.142	0.709	0.984	0.098	2.323
TMCU 06-06	3/8	3/8	0.630	0.295	1.988	1.142	0.709	0.984	0.098	2.323
TMCU 06-08	1/2	3/8	0.630	0.335	2.028	1.142	0.709	0.984	0.098	2.362

METRIC TUBE										
DIMENSIONS										
Model	A	B	F	H	L	M	S	SW	SW1	Z
TMCU 972-1/8-4	G1/8	4	11.5	5	43	21.5	16.5	16	1.5	50
TMCU 974-1/8-6	G1/8	6	11.5	5	43	21.5	16.5	16	1.5	50
TMCU 974-1/4-6	G1/4	6	11.5	6	44	21.5	16.5	17	1.5	51
TMCU 976-1/8-8	G1/8	8	13.5	5	47	25	17.5	19	2.5	54
TMCU 976-1/4-8	G1/4	8	13.5	6	48.5	25	18	19	2.5	55.5
TMCU 976-3/8-8	G3/8	8	13.5	7	49.5	25	18	20	2.5	56.5
TMCU 978-3/8-10	G3/8	10	16	7	51	29	17	25	2.5	59.5
TMCU 978-1/2-10	G1/2	10	16	8	52	29	17	25	2.5	60.5

Series TMVU valves

Unidirectional flow controller for mounting on valves.
Adjustment of setting by a hexagonal male key or a manually operated knurled screw.
Ports: 1/8", 1/4", 3/8", 1/2" NPTF
G1/8, G1/4, G3/8, G1/2

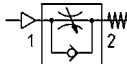

NPTF Threads

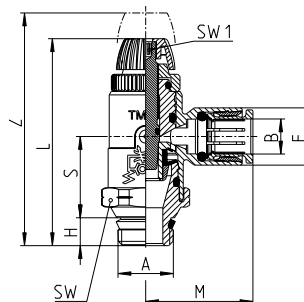

BSP Threads

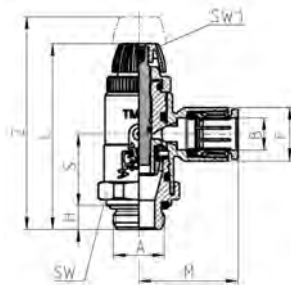

DIMENSIONS (in inches)										
Model	A	B	F	H	L	M	S	SW	SW1	Z
	NPTF	OD								
TMVU 53-02	1/8	5/32	0.453	0.197	1.654	0.846	0.728	0.630	0.059	1.929
TMVU 04-02	1/8	1/4	0.453	0.197	1.654	0.846	0.728	0.630	0.059	1.929
TMVU 04-04	1/4	1/4	0.453	0.256	1.732	0.846	0.709	0.630	0.059	2.008
TMVU 05-04	1/4	5/16	0.531	0.256	1.890	0.984	0.748	0.748	0.098	2.165
TMVU 05-06	3/8	5/16	0.531	0.295	1.929	0.984	0.748	0.748	0.098	2.205
TMVU 06-04	1/4	3/8	0.630	0.256	1.988	1.142	0.709	0.984	0.098	2.323
TMVU 06-06	3/8	3/8	0.630	0.295	1.988	1.142	0.709	0.984	0.098	2.323
TMVU 06-08	1/2	3/8	0.630	0.335	2.028	1.142	0.709	0.984	0.098	2.362

DIMENSIONS										
Model	A	B	F	H	L	M	S	SW	SW1	Z
TMVU 972-1/8-4	G1/8	4	11.5	5	43	21.5	16.5	16	1.5	50
TMVU 974-1/8-6	G1/8	6	11.5	5	43	21.5	16.5	16	1.5	50
TMVU 974-1/4-6	G1/4	6	11.5	6	44	21.5	16.5	17	1.5	51
TMVU 976-1/8-8	G1/8	8	13.5	5	47	25	17.5	19	2.5	54
TMVU 976-1/4-8	G1/4	8	13.5	6	48.5	25	18	19	2.5	55.5
TMVU 976-3/8-8	G3/8	8	13.5	7	49.5	25	18	20	2.5	56.5
TMVU 978-3/8-10	G3/8	10	16	7	51	29	17	25	2.5	59.5
TMVU 978-1/2-10	G1/2	10	16	8	52	29	17	25	2.5	60.5

Series TMC0 valves

Bidirectional flow controller.
Adjustment of setting by a hexagonal male key or a manually operated knurled screw.
Ports: 1/8", 1/4", 3/8", 1/2" NPTF
G1/8, G1/4, G3/8, G1/2

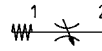

DIMENSIONS (in inches)										
Model	A	B	F	H	L	M	S	SW	SW1	Z
	NPTF	OD								
TMCO 53-02	1/8	5/32	0.453	0.197	1.654	0.846	0.728	0.630	0.059	1.929
TMCO 04-02	1/8	1/4	0.453	0.197	1.654	0.846	0.728	0.630	0.059	1.929
TMCO 04-04	1/4	1/4	0.453	0.256	1.732	0.846	0.709	0.630	0.059	2.008
TMCO 05-04	1/4	5/16	0.531	0.256	1.890	0.984	0.748	0.748	0.098	2.165
TMCO 05-06	3/8	5/16	0.531	0.295	1.929	0.984	0.748	0.748	0.098	2.205
TMCO 06-04	1/4	3/8	0.630	0.256	1.988	1.142	0.709	0.984	0.098	2.323
TMCO 06-06	3/8	3/8	0.630	0.295	1.988	1.142	0.709	0.984	0.098	2.323
TMCO 06-08	1/2	3/8	0.630	0.335	2.028	1.142	0.709	0.984	0.098	2.362

DIMENSIONS										
Model	A	B	F	H	L	M	S	SW	SW1	Z
	TMCO 972-1/8-4	G1/8	4	11.5	5	43	21.5	16.5	16	1.5
TMCO 974-1/8-6	G1/8	6	11.5	5	43	21.5	16.5	16	1.5	50
TMCO 974-1/4-6	G1/4	6	11.5	6	44	21.5	16.5	17	1.5	51
TMCO 976-1/8-8	G1/8	8	13.5	5	47	25	17.5	19	2.5	54
TMCO 976-1/4-8	G1/4	8	13.5	6	48.5	25	18	19	2.5	55.5
TMCO 976-3/8-8	G3/8	8	13.5	7	49.5	25	18	20	2.5	56.5
TMCO 978-3/8-10	G3/8	10	16	7	51	29	17	25	2.5	59.5
TMCO 978-1/2-10	G1/2	10	16	8	52	29	17	25	2.5	60.5

NPTF Threads

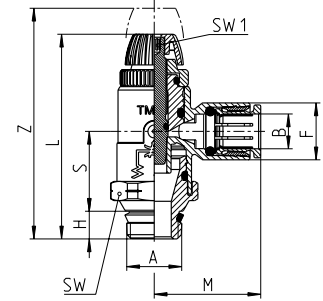

BSP Threads

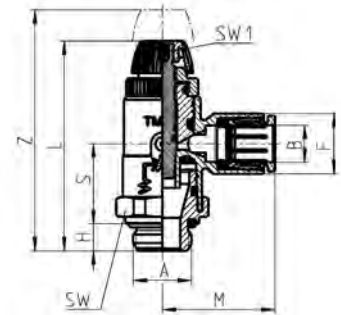

Non-Swivel Banjo Style Composite Right Angle Flow Control Valves

BSP/Metric Series PSCU, PMCU, PSVU, PMVU, PSCO, PMCO

Non-Swivel Design: Meter-Out, Meter-In and Needle Orifice

Tube Diameter OD : 4mm, 6mm, 8mm, 10mm, 12mm

Thread Type : Metric (M5), BSP (G1/8, G1/4, G3/8) with Spot-Face O-ring Seal



These unidirectional and bidirectional flow controllers have been designed as small as possible so as to be mounted directly on valves or cylinders. The great variety of adjustable fittings makes it possible to complete the regulator with the most suitable system in relation to the available tube.

All models are supplied complete with banjo flow controllers.

GENERAL DATA

Construction	needle type
Valve group	unidirectional and bidirectional controller (meter-out, meter-in, needle-orifice)
Materials	body, regulation screw: stainless steel (M5), brass (G1/8 - G1/4 - G3/8) collet and insert = brass banjo: brass (M5), technopolymer/glass reinforced Nylon 66 (G1/8 - G1/4 - G3/8) controller = technopolymer - seals = NBR/Buna-N
Mounting	by male thread
Ports	M5 - G1/8 - G1/4 - G3/8
Installation	in any position
Operating temperature	0°C - 60°C (with dry air -20°C) (32° - 175° F, dry air necessary down to -4° F)
Operating pressure	1 - 10 bar (14.5 - 145 psi)
Nominal pressure	6 bar (87 psi)
Nominal flow	see graph
Nominal diameter	M5 = 1.5 mm - G1/8 = 2 mm - G1/4 = 4 mm - G3/8 = 7 mm
Fluid	filtered air

CODING EXAMPLE

P	M	CU	7	04	-	1/8	-	4
P	SERIES							
M	ACTUATION: M = Manual S = Screwdriver							
CU	ASSEMBLY: CU = on cylinders unidirectional, meter-out VU = on valves unidirectional, meter-in CO = bidirectional, needle-orifice							
7	VERSIONS: 6 = needle (screwdriver operated) 7 = needle (manual operated)							
04	NOMINAL DIAMETER (flow orifice): 02 = Ø1.5 MAX 04 = Ø2 MAX 06 = Ø4 MAX 08 = Ø7 MAX							
1/8	PORTS: M5 = M5 1/8 = G1/8 1/4 = G1/4 3/8 = G3/8							
4	TUBE: 4 = Ø 4 6 = Ø 6 8 = Ø 8 10 = Ø 10 12 = Ø 12							

To ensure the right choice of unidirectional flow controller, proceed as follows:
calculate the quantity of air in NI/min (see cylinders table); determine the stroke time of the cylinder; refer to graph to see which is the right type of controller.

UNIDIRECTIONAL AND BIDIRECTIONAL FLOW CONTROLLERS

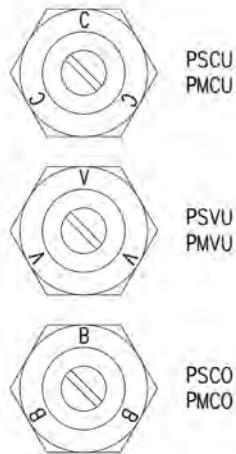

IDENTIFICATION OF DIFFERENT TYPES:
 PSCU - PMCU = assembly directly on the cylinders
 PSVU - PMVU = assembly directly on the valves
 PSCO - PMCO = assembly directly on the cylinders or valves

UNIDIRECTIONAL AND BIDIRECTIONAL FLOW CONTROL REGULATORS

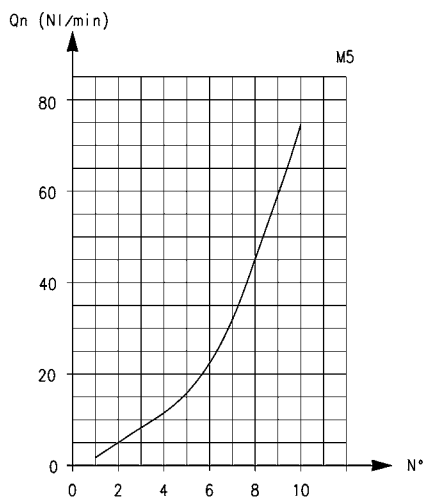

Flow Qn (NL/min.) from 2 → 1 with controller OPEN: 70
Flow Qn (NL/min.) from 2 → 1 with controller CLOSED: 33

Qn = supply pressure of 6 bar and with ΔP = 1 bar at the outlet
N° = number of screw turns

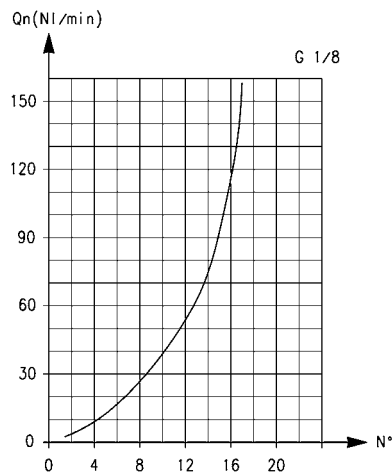

Flow Qn (NL/min.) from 2 → 1 with controller OPEN: 200
Flow Qn (NL/min.) from 2 → 1 with controller CLOSED: 70

Qn = supply pressure of 6 bar and with ΔP = 1 bar at the outlet
N° = number of screw turns

UNIDIRECTIONAL AND BIDIRECTIONAL FLOW CONTROL REGULATORS

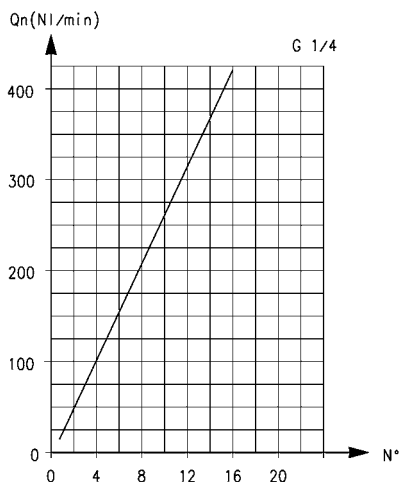

Flow Qn (NL/min.) from 2 → 1 with controller OPEN: 530
Flow Qn (NL/min.) from 2 → 1 with controller CLOSED: 160

Qn = supply pressure of 6 bar and with ΔP = 1 bar at the outlet
N° = number of screw turns

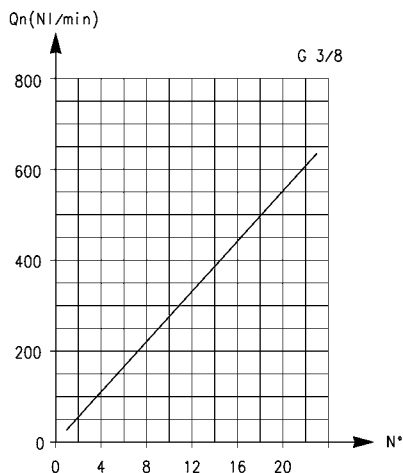

Flow Qn (NL/min.) from 2 → 1 with controller OPEN: 710
Flow Qn (NL/min.) from 2 → 1 with controller CLOSED: 410

Qn = supply pressure of 6 bar and with ΔP = 1 bar at the outlet
N° = number of screw turns

Unidirectional flow controllers Series PSCU

For mounting on single-acting or double-acting cylinders.
A screwdriver must be used to adjust the registration setting.
Ports: M5, G1/8, G1/4 and G3/8.

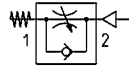

Port M5: banjo in brass

DIMENSIONS (in mm)									
Model	A	B	G	H	L	N	S	W	SW
PSCU 602-M5-4	M5	4	8.6	3.5	21.5	18	5.7	8	8
PSCU 602-M5-6	M5	6	10.4	3.5	21.5	19	5.7	8	8
PSCU 604-1/8-4	G1/8	4	11.6	5	27	21	7.75	14	12
PSCU 604-1/8-6	G1/8	6	11.6	5	27	21	7.75	14	12
PSCU 604-1/8-8	G1/8	8	13.9	5	27	22.5	7.75	14	12
PSCU 606-1/4-6	G1/4	6	13.9	6	30.5	24.5	9.25	18.6	15
PSCU 606-1/4-8	G1/4	8	13.9	6	30.5	24.5	9.25	18.6	15
PSCU 606-1/4-10	G1/4	10	16.1	6	30.5	27	9.25	18.6	15
PSCU 608-3/8-10	G3/8	10	20.2	7	36.5	29	11	22	18
PSCU 608-3/8-12	G3/8	12	20.2	7	36.5	29	11	22	18

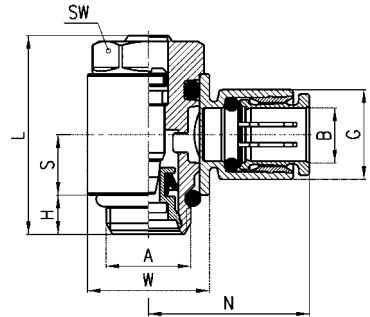

Unidirectional flow controllers Series PMCU

For mounting on single-acting or double-acting cylinders.
A manually operated knurled screw must be used to adjust the registration setting.
Ports: M5, G1/8, G1/4 and G3/8.

Port M5: banjo in brass

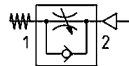

Port M5: banjo in brass

DIMENSIONS (in mm)											
Model	A	B	G	H	L	N	S	W	SW	SW1	Z
PMCU 702-M5-4	M5	4	8.6	3.5	31	18	5.7	8	8	5.5	35
PMCU 702-M5-6	M5	6	10.4	3.5	31	19	5.7	8	8	5.5	35
PMCU 704-1/8-4	G1/8	4	11.6	5	36.5	21	7.75	14	12	7	42.5
PMCU 704-1/8-6	G1/8	6	11.6	5	36.5	21	7.75	14	12	7	42.5
PMCU 704-1/8-8	G1/8	8	13.9	5	36.5	22.5	7.75	14	12	7	42.5
PMCU 706-1/4-6	G1/4	6	13.9	6	42	24.5	9.25	18.6	15	7	48
PMCU 706-1/4-8	G1/4	8	13.9	6	42	24.5	9.25	18.6	15	7	48
PMCU 706-1/4-10	G1/4	10	16.1	6	42	27	9.25	18.6	15	7	48
PMCU 708-3/8-10	G3/8	10	20.2	7	48.5	29	11	22	18	10	56.5
PMCU 708-3/8-12	G3/8	12	20.2	7	48.5	29	11	22	18	10	56.5

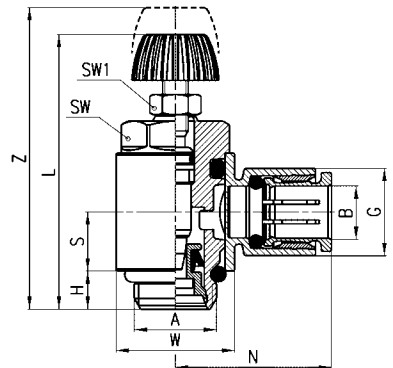

Unidirectional flow controllers Series PSVU

For mounting on valves.
A screwdriver must be used to adjust the registration setting.
Ports: M5, G1/8, G1/4 and G3/8.

Port M5: banjo in brass

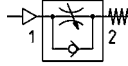

Port M5: banjo in brass

DIMENSIONS (in mm)									
Model	A	B	G	H	L	N	S	W	SW
PSVU 602-M5-4	M5	4	8.6	3.5	21.5	18	5.7	8	8
PSVU 602 M5-6	M5	6	10.4	3.5	21.5	19	5.7	8	8
PSVU 604-1/8-4	G1/8	4	11.6	5	27	21	7.75	14	12
PSVU 604-1/8-6	G1/8	6	11.6	5	27	21	7.75	14	12
PSVU 604-1/8-8	G1/8	8	13.9	5	27	22.5	7.75	14	12
PSVU 606-1/4-6	G1/4	6	13.9	6	30.5	24.5	9.25	18.6	15
PSVU 606-1/4-8	G1/4	8	13.9	6	30.5	24.5	9.25	18.6	15
PSVU 606-1/4-10	G1/4	10	16.1	6	30.5	27	9.25	18.6	15
PSVU 608-3/8-10	G3/8	10	20.2	7	36.5	29	11	22	18
PSVU 608-3/8-12	G3/8	12	20.2	7	36.5	29	11	22	18

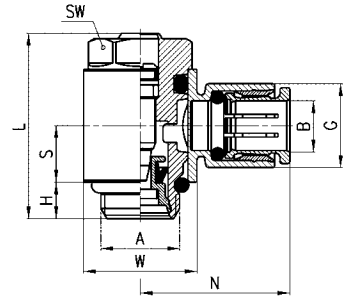

Unidirectional flow controllers Series PMVU

For mounting on valve.
A manually operated knurled screw must be used to adjust the registration setting.
Ports: M5, G1/8, G1/4 and G3/8.

Port M5: banjo in brass

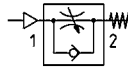

Port M5: banjo in brass

DIMENSIONS (in mm)											
Model	A	B	G	H	L	N	S	W	SW	SW1	Z
PMVU 702-M5-4	M5	4	8.6	3.5	31	18	5.7	8	8	5.5	35
PMVU 702-M5-6	M5	6	10.4	3.5	31	19	5.7	8	8	5.5	35
PMVU 704-1/8-4	G1/8	4	11.6	5	36.5	21	7.75	14	12	7	42.5
PMVU 704-1/8-6	G1/8	6	11.6	5	36.5	21	7.75	14	12	7	42.5
PMVU 704-1/8-8	G1/8	8	13.9	5	36.5	22.5	7.75	14	12	7	42.5
PMVU 706-1/4-6	G1/4	6	13.9	6	42	24.5	9.25	18.6	15	7	48
PMVU 706-1/4-8	G1/4	8	13.9	6	42	24.5	9.25	18.6	15	7	48
PMVU 706-1/4-10	G1/4	10	16.1	6	42	27	9.25	18.6	15	7	48
PMVU 708-3/8-10	G3/8	10	20.2	7	48.5	29	11	22	18	10	56.5
PMVU 708-3/8-12	G3/8	12	20.2	7	48.5	29	11	22	18	10	56.5

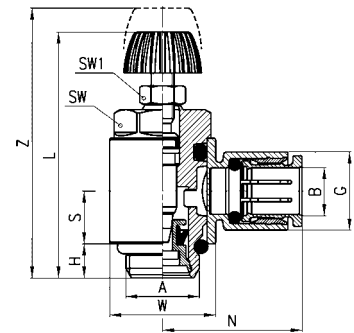

Bidirectional flow controllers Series PSCO

A screwdriver must be used to adjust the registration setting.

Ports: M5, G1/8, G1/4 and G3/8.

Port M5: banjo in brass

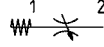

Port M5: banjo in brass

DIMENSIONS (in mm)									
Model	A	B	G	H	L	N	S	W	SW
PSCO 602-M5-4	M5	4	8.6	3.5	21.5	18	5.7	8	8
PSCO 602-M5-6	M5	6	10.4	3.5	21.5	19	5.7	8	8
PSCO 604-1/8-4	G1/8	4	11.6	5	27	21	7.75	14	12
PSCO 604-1/8-6	G1/8	6	11.6	5	27	21	7.75	14	12
PSCO 604-1/8-8	G1/8	8	13.9	5	27	22.5	7.75	14	12
PSCO 606-1/4-6	G1/4	6	13.9	6	30.5	24.5	9.25	18.6	15
PSCO 606-1/4-8	G1/4	8	13.9	6	30.5	24.5	9.25	18.6	15
PSCO 606-1/4-10	G1/4	10	16.1	6	30.5	27	9.25	18.6	15
PSCO 608-3/8-10	G3/8	10	20.2	7	36.5	29	11	22	18
PSCO 608-3/8-12	G3/8	12	20.2	7	36.5	29	11	22	18

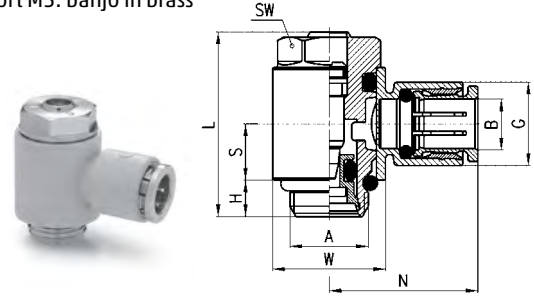

Bidirectional flow controllers Series PMCO

A manually operated knurled screw must be used to adjust the registration setting.

Ports: M5, G1/8, G1/4 and G3/8.

Port M5: banjo in brass

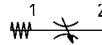

Port M5: banjo in brass

DIMENSIONS (in mm)											
Model	A	B	G	H	L	N	S	W	SW	SW1	Z
PMCO 702-M5-4	M5	4	8.6	3.5	31	18	5.7	8	8	5.5	35
PMCO 702-M5-6	M5	6	10.4	3.5	31	19	5.7	8	8	5.5	35
PMCO 704-1/8-4	G1/8	4	11.6	5	36.5	21	7.75	14	12	7	42.5
PMCO 704-1/8-6	G1/8	6	11.6	5	36.5	21	7.75	14	12	7	42.5
PMCO 704-1/8-8	G1/8	8	13.9	5	36.5	22.5	7.75	14	12	7	42.5
PMCO 706-1/4-6	G1/4	6	13.9	6	42	24.5	9.25	18.6	15	7	48
PMCO 706-1/4-8	G1/4	8	13.9	6	42	24.5	9.25	18.6	15	7	48
PMCO 706-1/4-10	G1/4	10	16.1	6	42	27	9.25	18.6	15	7	48
PMCO 708-3/8-10	G3/8	10	20.2	7	48.5	29	11	22	18	10	56.5
PMCO 708-3/8-12	G3/8	12	20.2	7	48.5	29	11	22	18	10	56.5

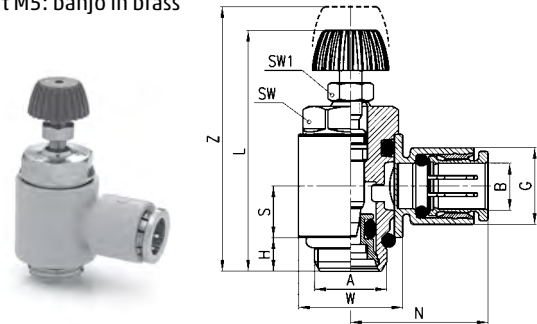

Fittings Model 7610 assembled with Model 7632 02, 7632 03

Single Banjo

DIMENSIONS (in mm)							
Model	A	G	N	O	V	W	Weight (g)
7610 4-1/8	4	11.6	21	15.5	11	14	3
7610 6-1/8	6	11.6	21	15.5	11	14	4
7610 6-1/4	6	13.9	24.5	18.5	15.5	18.5	6
7610 8-1/8	8	13.9	22.5	15.5	11	14	5
7610 8-1/4	8	13.9	24.5	18.5	15.5	18.5	7
7610 10-1/4	10	16.1	27	18.5	15.5	18.5	7
7610 10-3/8	10	20.2	29	22	18	22	11
7610 12-3/8	12	20.2	29	22	18	22	12

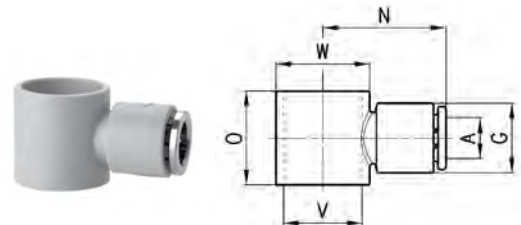

METRIC Tube Fittings

In-line Flow Control Valves Series RFU, RFO

Panel/Wall-Mount Design: Meter-Out, Meter-In and Needle Orifice

Thread Type: UNF 10-32

NPTF 1/8", 1/4"

BSP G1/8, G1/4, G3/8, G1/2



- » Series RFU: unidirectional flow control valves for the speed regulation of a cylinder
- » Series RFO: bidirectional flow control valves for the air flow regulation in both directions and for the pressurization or depressurization of a container.

The unidirectional flow controllers are available with two different types of adjustment (see diagrams). G3/8 and G1/2 ports have just one type of adjustment.

They are used mainly for controlling the speed of cylinders.

All models can be panel or wall mounted or they can be mounted on cylinders, as required.

GENERAL DATA

Construction	In-Line Needle type
Valve group	Unidirectional controller (meter-in, meter-out) and Bidirectional (needle-orifice)
Materials	Aluminum body, Brass needle (not nickel-plated), NBR seals (Buna-N)
Mounting	with screws in the holes of the valve body or panel mounted
Threaded ports	10-32 UNF, 1/8", 1/4", NPTF M5 - G1/8 - G1/4 - G3/8 - G1/2 BSP
Installation	as required
Operating temperature	32° - 175° F (dry air necessary down to -4° F)
Operating pressure	1.0 - 10 bar (14.5 - 145 psi) 2 - 10 bar (29 - 145 psi) (for models with G3/8 - G1/2 ports)
Nominal pressure	6 bar (87 psi)
Nominal flow	see graph
Nominal diameter (flow orifice)	1/8" = 2 mm (.079"), or 3 mm (.118") 1/4" = 4 mm (.157"), or 6 mm (.236") 3/8" and 1/2" = 7 mm (.272")
Fluid	filtered air
Lubricant	Oil compatible with Buna-N (3° - 10°F)
	*Qn flowrate (SCFM) determined iwht a supply pressure of 6 bar (87 psi), and with a pressure drop of 1 bar (14.5 psi). **Dimensions are in inches.

CODING EXAMPLE

RF	U4	8	2	-	02
RF	SERIES: RF				
U4	FUNCTION: U4 = unidirectional, meter out/meter in 03 = bidirectional, needle-orifice (BSP threads only)				
8	PORTS 5 = M5 or 10-32 UNF 8 = 1/8" NPTF or G1/8 BSP 4 = 1/4" NPTF or G1/4 BSP 6 = G3/8 BSP 7 = G1/2 BSP				
2	FLOW CONTROL RANGE: 2 = \emptyset 2 max 3 = \emptyset 3 max 4 = \emptyset 4 max 6 = \emptyset 6 max 7 = \emptyset 7 max				
02	PORTS M5 = M5 (10-32 UNF) NPTF 02 = 1/8" NPTF 04 = 1/4" NPTF BSP 1/8 = G1/8 1/4 = G1/4 3/8 = G3/8 1/2 = G1/2				

EXAMPLES OF VALVES SERIES RFO - RFU ASSEMBLY

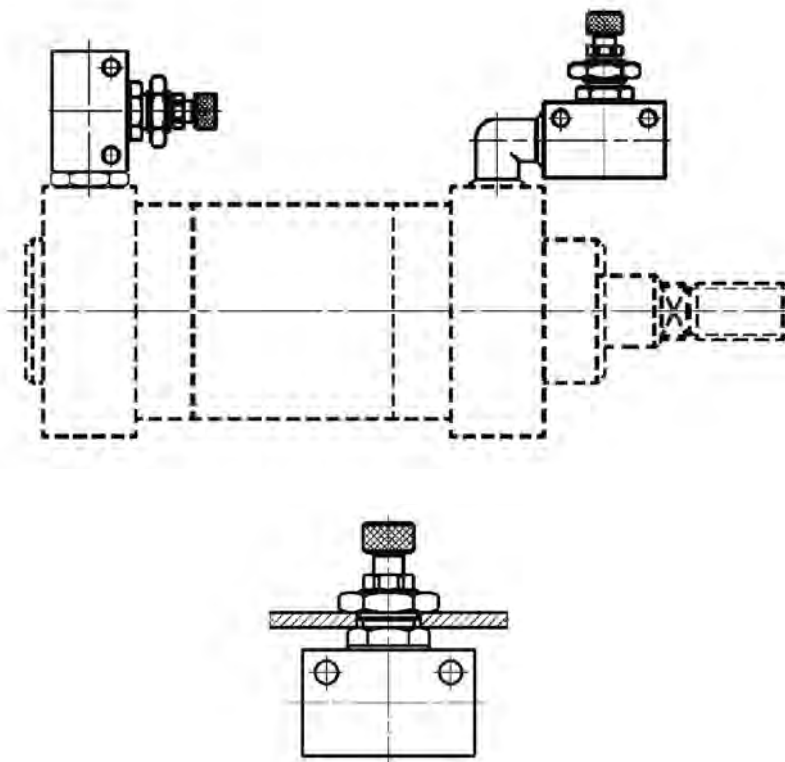

FLOW CONTROLLER SELECTION

4

To ensure the right choice of flow controller, proceed as follows: calculate the quantity of air in NL/min. (see cylinder table), determine the stroke time of the cylinder; refer to the graph to see which controller is the right type. In the case of bidirectional regulators, refer to the graph and check whether the flow control range is suitable for the work required.

FLOW DIAGRAMS (1 → 2) - VALVES SERIES RFU / RFO - M5, 10/32 PORTS

RFU-452

flow from B → A needle type
 OPEN = 55 NL/min [1.94 SCFM]
 CLOSED = 41 NL/min [1.45 SCFM]

NB: Qn is determined with a pressure of 6 bar at the inlet and ΔP=1 bar at the outlet.
 N° = number of screw turns

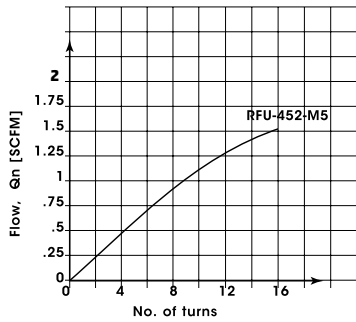

RFO 352-M5

N° = number of screw turns
 Note: the flow (Qn) is determined with a pressure of 6 bar at the inlet and ΔP = 1 bar at the outlet.

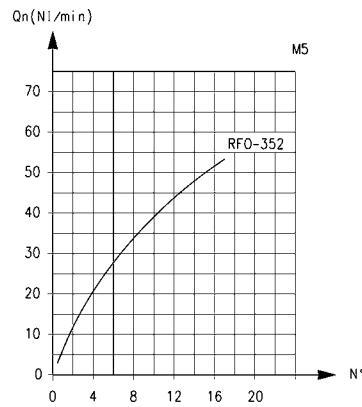

FLOW CONTROL VALVES

FLOW DIAGRAMS (1 → 2) - VALVES SERIES RFU / RFO - 1/8 PORTS

RFU 482 BSP / NPT

flow from B → A needle type
 OPEN = 149 NL/min [6.32 SCFM]
 CLOSED = 130.5 NL/min [4.61 SCFM]

RFU 483

flow from B → A needle type
 OPEN = 180 NL/min [6.36 SCFM]
 CLOSED = 140 NL/min [4.94 SCFM]

NB: Qn is determined with a pressure of 6 bar at the inlet and ΔP = 1 bar at the outlet.

N° = number of screw turns.

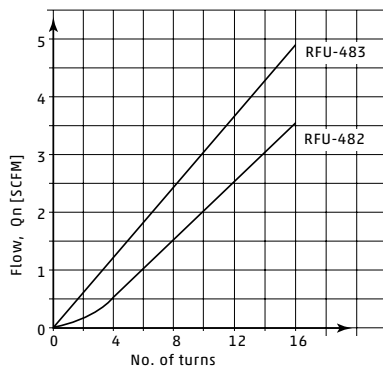

RFO 382-1/8 - RFO 383-1/8 (BSP Only)

N° = number of screw turns
 Note: the flow (Qn) is determined with a pressure of 6 bar at the inlet and ΔP = 1 bar at the outlet.

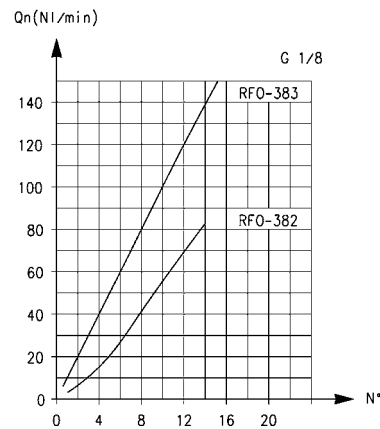

FLOW DIAGRAMS (1 → 2) - VALVES SERIES RFU / RFO - 1/4" NPTF, G1/4 PORTS

RFU 444

flow from B → A needle type

OPEN = 680 NL/min
[24.01 SCFM]
CLOSED = 534 NL/min
[18.86 SCFM]

RFU 446

flow from B → A needle type

OPEN = 680 NL/min
[24.01 SCFM]
CLOSED = 534 NL/min
[18.86 SCFM]

NB: Qn is determined with a pressure of 6 bar at the inlet and ΔP = 1 bar at the outlet.

N° = number of screw turns.

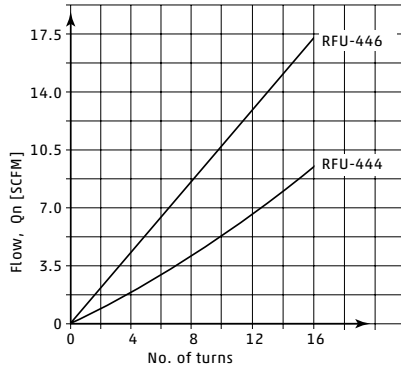

RFO 344-1/4 - RFO 346-1/4

N° = number of screw turns.

Note: the flow (Qn) is determined with a pressure of 6 bar at the inlet and ΔP = 1 bar at the outlet.

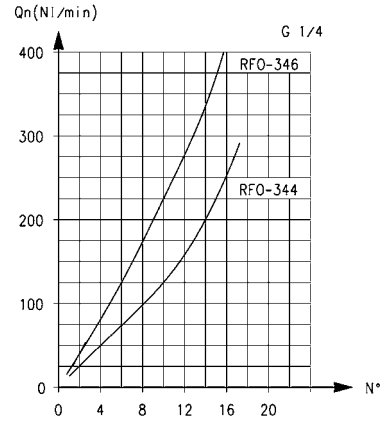

FLOW DIAGRAMS (1 → 2) - VALVES SERIES RFU / RFO - G3/8, G1/2 PORTS

RFU 467-3/8:

flow from 2 → 1 needle type

OPEN = 1700 NL/min
CLOSED = 1700 NL/min

RFU 477-1/2:

flow from 2 → 1 needle type

OPEN = 1700 NL/min
CLOSED = 1700 NL/min

N° = number of screw turns

Note: the flow (Qn) is determined with a pressure of 6 bar at the inlet and ΔP = 1 bar at the outlet.

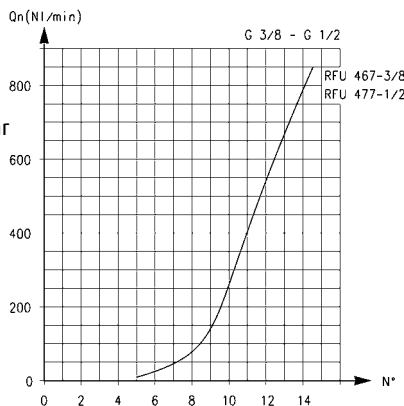

RFO 367-3/8 - RFO 377-1/2

N° = number of screw turns

Note: the flow (Qn) is determined with a pressure of 6 bar at the inlet and ΔP = 1 bar at the outlet.

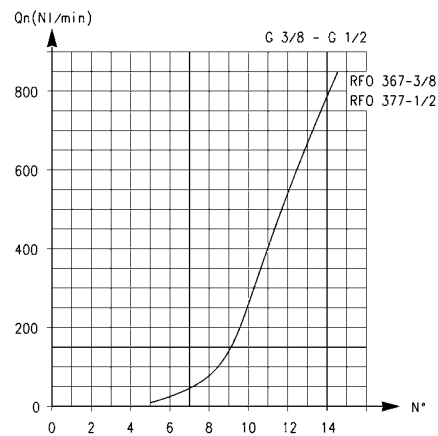

Unidirectional flow controller Series RFU

To regulate the speed of a cylinder, the air flow from the chamber which is being discharged must be regulated.

For this reason, the unidirectional flow controller must be connected as follows:
connect the threaded outlet marked A to the cylinder inlet and the threaded outlet marked B to the valve user port.

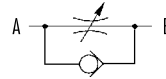

NPTF Threads

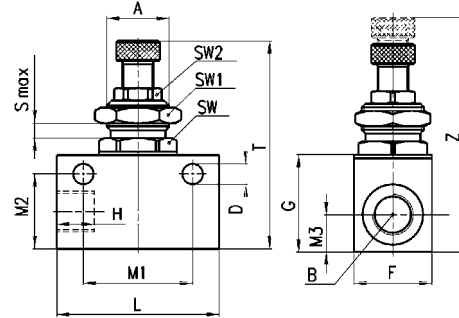

NPT THREADS

DIMENSIONS (in inches)

Model	A	B	H	D	F	G	L	M1	M2	M3	T	Z	SMax	SW	SW1	SW2
	METRIC	UNF														
RFU 452-M5	M10x1	10-32	.256	.165	.551	.630	1.02	.728	.520	.280	1.54	1.750	.118	.472	.551	.315
		NPTF														
RFU 482-02	M12x1	1/8"	.354	.177	.629	.826	1.338	.964	.649	.315	1.811	2.007	.157	.551	.669	.354
RFU 483-02	M12x1	1/8"	.354	.177	.629	.826	1.338	.964	.649	.315	1.811	2.007	.157	.551	.669	.354
RFU 444-04	M20x1.5	1/4"	.492	.255	.984	1.181	2.047	1.377	.944	.472	2.362	2.716	.275	.866	.944	.551
RFU 446-04	M20x1.5	1/4"	.492	.255	.984	1.181	2.047	1.377	.944	.472	2.362	2.716	.275	.866	.944	.551

BSP Threads

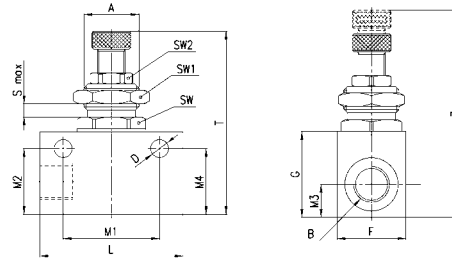

BSP THREADS

DIMENSIONS (in mm)

Model	g_N	A	B	D	F	G	L	M1	M2	M3	M4	T	Z	S_{Max}	SW	SW1	SW2
RFU 452-M5	1.5	M10x1	M5	4.2	14	16	26	18.5	13.2	7	13.2	39	44.5	3	12	14	8
RFU 482-1/8	2	M12x1	G1/8	4.5	16	21	34	24.5	16.5	8	16.5	46	51	4	14	17	9
RFU 483-1/8	3	M12x1	G1/8	4.5	16	21	34	24.5	16.5	8	16.5	46	51	4	14	17	9
RFU 444-1/4	4	M20x1.5	G1/4	6.5	25	30	52	35	24	12	24	60	69	7	22	24	14
RFU 446-1/4	6	M20x1.5	G1/4	6.5	25	30	52	35	24	12	24	60	69	7	22	24	14
RFU 467-3/8	7	M18x1	G3/8	6.5	27	42	56	43	34.5	28	7.5	75	85	8	22	22	*
RFU 477-1/2	7	M18x1	G1/2	6.5	27	42	56	43	34.5	28	7.5	75	85	8	22	22	*

Bidirectional flow control valves Series RFO

4

FLOW CONTROL VALVES

TABLE NOTE:

* knurled ring nut

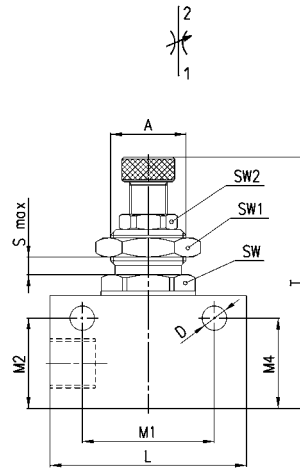

BSP Threads

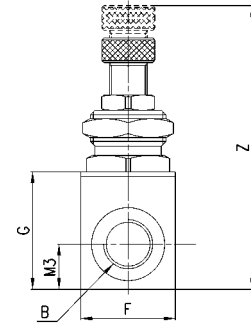

BSP THREADS

DIMENSIONS (in mm)

Model	$\frac{1}{8}$ N	A	B	D	F	G	L	M1	M2	M3	M4	T	Z	S_{Max}	SW	SW1	SW2
RFO 352-M5	1.5	M10x1	M5	4.2	14	16	26	18.5	13.2	7	13.2	39	44.5	3	12	14	8
RFO 382-1/8	2	M12x1	G1/8	4.2	16	21	34	24.5	16.5	8	16.5	46	51	4	14	17	9
RFO 383-1/8	3	M12x1	G1/8	4.5	16	21	34	24.5	16.5	8	16.5	46	51	4	14	17	9
RFO 344-1/4	4	M20x1.5	G1/4	6.5	25	30	52	35	24	12	24	60	69	7	22	24	14
RFO 346-1/4	6	M20x1.5	G1/4	6.5	25	30	52	35	24	12	24	60	69	7	22	24	14
RFO 367-3/8	7	M18x1	G3/8	6.5	27	42	56	43	34.5	28	7.5	75	85	8	22	22	*
RFO 377-1/2	7	M18x1	G1/2	6.5	27	42	56	43	34.5	28	7.5	75	85	8	22	22	*

Nickel-Plated Brass Needle Valves BSP/Metric Series 28

Panel/Wall-Mount Design: Needle-Orifice
Thread Type: G1/8, G1/4, G3/8, G1/2



These are bidirectional control valves made entirely of nickel-plated brass, with NBR seals and a technopolymer control knob.

They are suitable for regulating compressed air, water or mineral oil. For models 2810, 2820, 2819 and 2829 exists the possibility to connect plastic, brass or copper tubes, using nut Model 1303 and ferrule sleeve Model 1310/1320.

GENERAL DATA

Construction	cone - type
Materials	body = nickel-plated brass control knob = technopolymer, glass-reinforced Nylon seals = NBR (Buna-N)
Ports	G1/8, G1/4, G3/8, G1/2
Installation	as required
Operating pressure	0°C - 80°C (with dry air - 20°) (32° - 175° F, dry air necessary down to -4° F)
Operating pressure	0 - 10 bar (0 - 145 psi)
Nominal flowrate	see table

Valve Model 2810

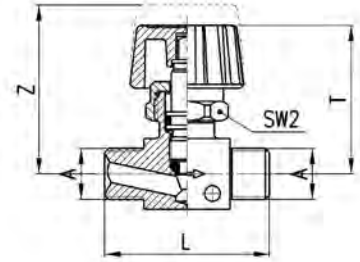

DIMENSIONS (in mm)

Model	A	L	T	Z	SW2	Δ 1bar NL/min	Free flow NL/min
2810 1/8	G1/8	40	37	42.5	19	415	590
2810 1/4	G1/4	42	37	42.5	19	508	740
2810 3/8	G3/8	42	37	42.5	19	620	900
2810 1/2	G1/2	54	42	48	22	1540	2080



Valve Model 2820

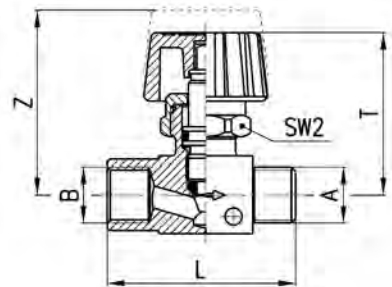

DIMENSIONS (in mm)

Model	A	B	L	T	Z	SW2	Δ 1bar NL/min	Free flow NL/min
2820 1/8	G1/8	G1/8	41	37	42.5	19	400	640
2820 1/4	G1/4	G1/4	44	37	42.5	19	530	840
2820 3/8	G3/8	G3/8	55.5	41.5	48	22	1415	1990
2820 1/2	G1/2	G1/2	59	42	49	22	1520	2150



Valve Model 2830

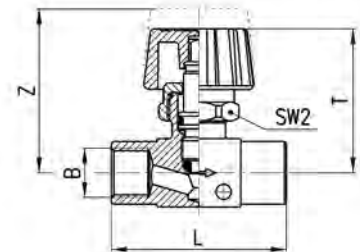

DIMENSIONS (in mm)

Model	B	L	T	Z	SW2	Δ 1bar NL/min	Free flow NL/min
2830 1/8	G1/8	42	37	42.5	19	415	635
2830 1/4	G1/4	46	37	42.5	19	530	850
2830 3/8	G3/8	62	41.4	48	22	1415	1980
2830 1/2	G1/2	64	42	49	22	1520	2100



Valve Model 2819

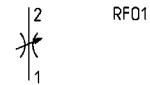
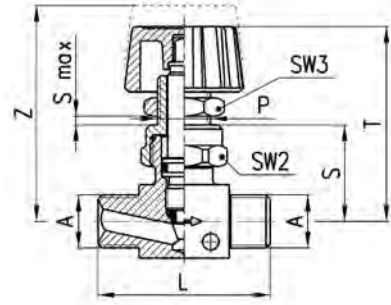

DIMENSIONS (in mm)

Model	A	L	P	S	T	Z	S _{max}	SW2	SW3
2819 1/8	G1/8	40	1/4	23	47	52.5	7	19	17
2819 1/4	G1/4	42	1/4	23	47	52.5	7	19	17

Valve Model 2829

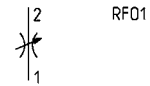
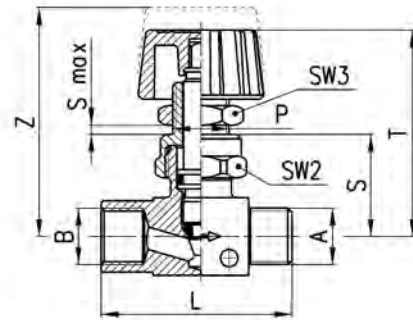

DIMENSIONS (in mm)

Model	A	B	L	P	S	T	Z	S _{max}	SW2	SW3
2829 1/8	G1/8	G1/8	41	1/4	23	47	52.5	7	19	17
2829 1/4	G1/4	G1/4	44	1/4	23	47	52.5	7	19	17

Valve Model 2839

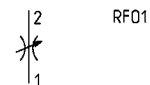
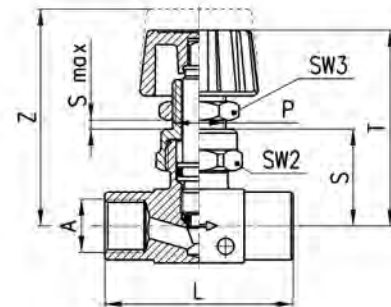

DIMENSIONS (in mm)

Model	A	L	P	S	T	Z	S _{max}	SW2	SW3
2839 1/8	G1/8	42	1/4	23	47	52.5	7	19	17
2839 1/4	G1/4	46	1/4	23	47	52.5	7	19	17
2839 3/8	G3/8	62	14X1	28	56.5	63	7	22	17
2839 1/2	G1/2	64	14X1	29	57	64	7	22	17

Nickel-Plated Brass Pilot-Operated Check Valve/ Blocking Valve BSP/Metric or NPT/Inch Series VBU VBO

Swivel Design : 4mm / 5/32" OD Push-In Fitting Pilot

Thread Type: BSP (G1/8, G1/4, G3/8, G1/2) with Sprint Reusable PTFE/Teflon Thread Seal

NPT (1/8, 1/4, 3/8)



- » Series VBU: unidirectional valves with operating pressure from 0.3 to 10 bar
- » Series VBO: bidirectional valves with operating pressure from 0 to 10 bar
- » Direct mounting on cylinders or on distribution and fluid control blocks

These unidirectional and bidirectional blocking valves have been realised in order to enable mounting directly on cylinders.

The inner design of the blocking valves Series VBO and VBU allows a very high flow rate and reliable operation.

These valves can be mounted directly also on distribution and fluid control blocks.

GENERAL DATA

Construction	poppet type
Valve group	unidirectional and bidirectional blocking valve (pilot-operated check and blocking valves, pilot connection 5/32" OD)
Materials	OT58 Nickel-Plated Brass Body, Buna-N seals, Teflon seal ring, internals brass
Mounting	by male thread
Ports	G1/8, G1/4, G3/8, G1/2, 1/8 NPT, 1/4 NPT, 3/8 NPT
Position	in any position
Operating temperature	0°C - 80°C (with dry air -20°C), 32°F - 175°F (dry air necessary down to -4° F)
Operating pressure	VBU: 0.3 - 10 bar (4.35 - 145 psi), VBO: 0 - 10 bar (0 - 145 psi)
Nominal pressure	6 bar (87 psi)
Nominal flow	see graph
Nominal diam. (flow orifice)	1/8 ø 5.5 mm - 1/4 ø 8 mm - 3/8 ø 11 mm - 1/2 ø 15 mm
Fluid	filtered air, without lubrication. If lubricated air is used, it is recommended to use oil ISO VG32. Once applied, the lubrication should never be interrupted.

CODING EXAMPLE

VB	U	1/8
-----------	----------	------------

VBSERIES:
VB**U**VERSIONS:
U = unidirectional, pilot-operated check valve
O = bidirectional, blocking valve**1/8**PORTS:
1/8 = G1/8 or NPT 1/8
1/4 = G1/4 or NPT 1/4
3/8 = G3/8
1/2 = G1/2

5

AUTOMATIC VALVES

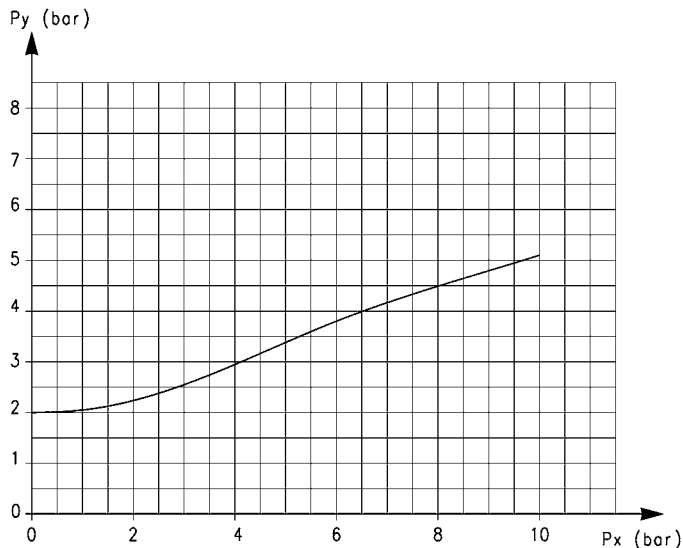
DIAGRAM OF THE PILOT PRESSURE (Pilot Connection 4mm / 5/32" Tube OD)

This diagram shows the relation between working pressure (P_x) and pilot pressure required in order to operate the valve (P_y).
The opening pressure of the unidirectional valve is 0.3 bar.

FLOW DIAGRAMS OF UNIDIRECTIONAL AND BIDIRECTIONAL VALVES

5

AUTOMATIC VALVES

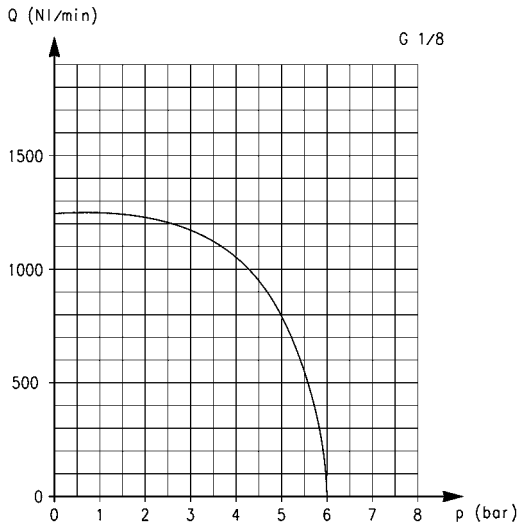

Diagram for valves VBU and VBO with G 1/8 or 1/8 NPT ports.

Q is the flow measured in NI/min and determined with an inlet pressure of 6 bar.

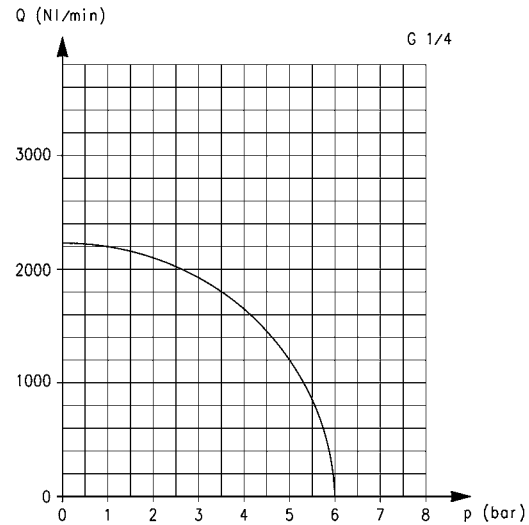

Diagram for valves VBU and VBO with G 1/4 or 1/4 NPT ports.

Q is the flow measured in NI/min and determined with an inlet pressure of 6 bar.

FLOW DIAGRAMS OF UNIDIRECTIONAL AND BIDIRECTIONAL VALVES

Diagram for valves VBU and VBO with G 3/8 ports.

Q is the flow measured in NI/min and determined with an inlet pressure of 6 bar.

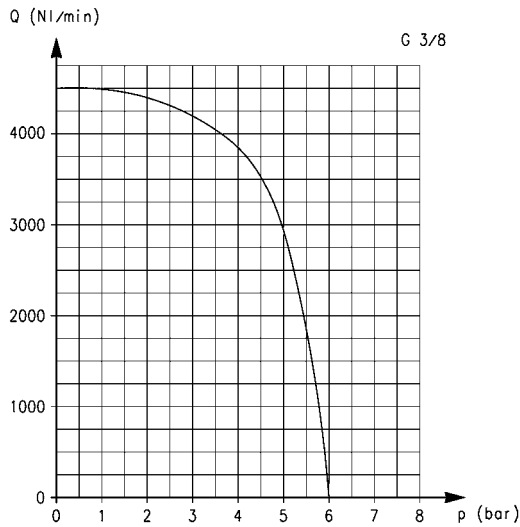
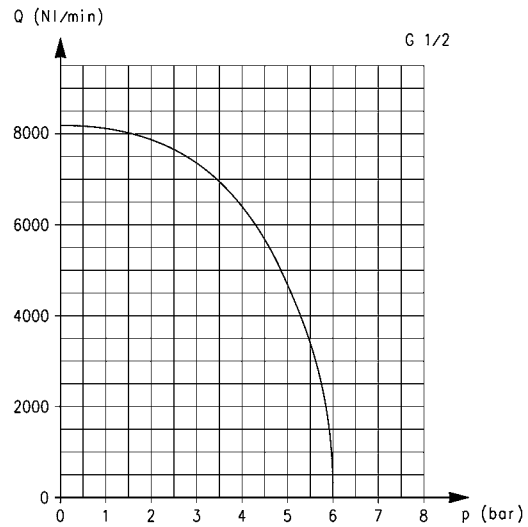
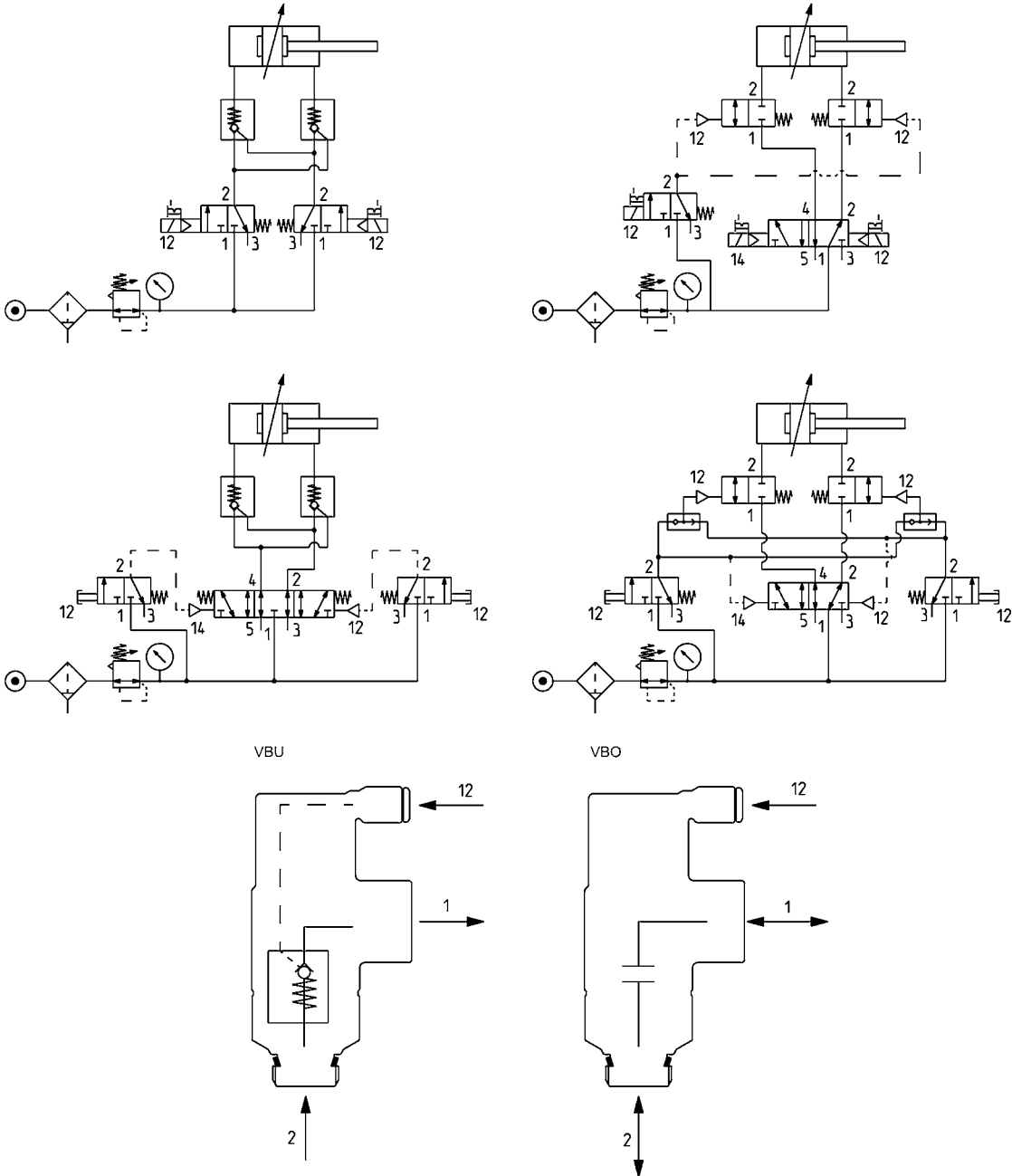

Diagram for valves VBU and VBO with G 1/2 ports.

Q is the flow measured in NI/min and determined with an inlet pressure of 6 bar.

APPLICATION SCHEMES

VBU = UNIDIRECTIONAL pilot-operated check valve
 VBO = BIDIRECTIONAL blocking valve



- 1 Inlet
- 2 Cylinder Port / Outlet
- 12 Pilot Connection (4mm 5/32" OD)

Unidirectional blocking valve NPT Thread

NPT Threads

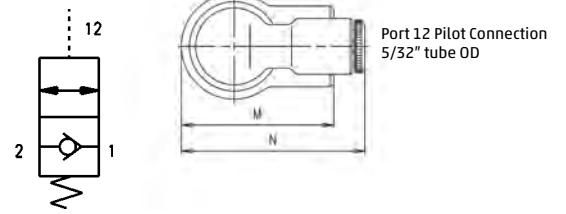
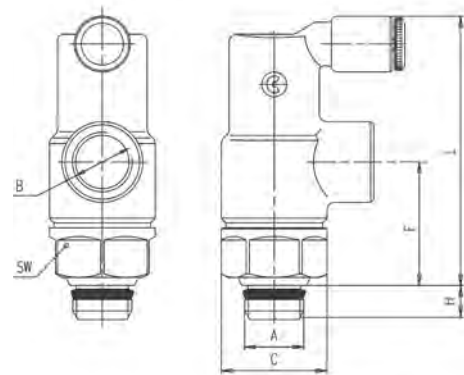

NPT THREADS									
DIMENSIONS (in inches)									
Model	A NPTF	B NPTF	C	F	H	L	M	N	SW
VBU 1/8	1/8"	1/8"	.665	.787	.216	1.692	.964	1.181	.590
VBU 1/4	1/4"	1/4"	.807	.984	.275	1.968	1.267	1.318	.748
VBU 06	3/8"	3/8"	1.055	1.299	.314	2.637	1.574	1.555	.944

Bidirectional blocking valve NPT Thread

NPT Threads

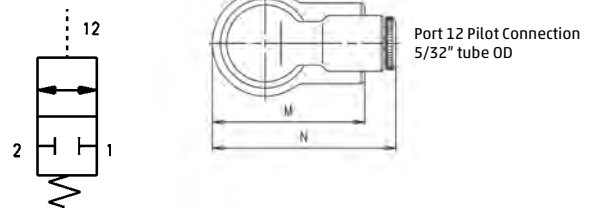
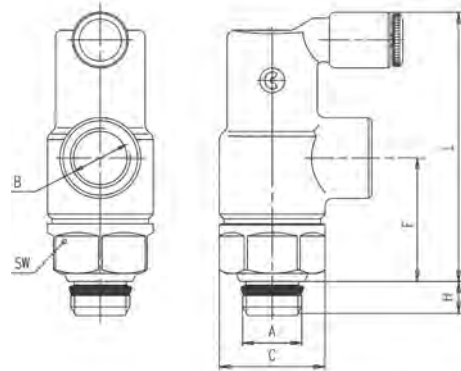

NPT THREADS									
DIMENSIONS (in inches)									
Model	A NPTF	B NPTF	C	F	H	L	M	N	SW
VBO 1/8	1/8"	1/8"	.665	.787	.216	1.692	.964	1.181	.590
VBO 1/4	1/4"	1/4"	.807	.984	.275	1.968	1.267	1.318	.748
VBO 06	3/8"	3/8"	1.055	1.299	.314	2.637	1.574	1.555	.944

Unidirectional blocking valve BSP Valve

METRIC Tube

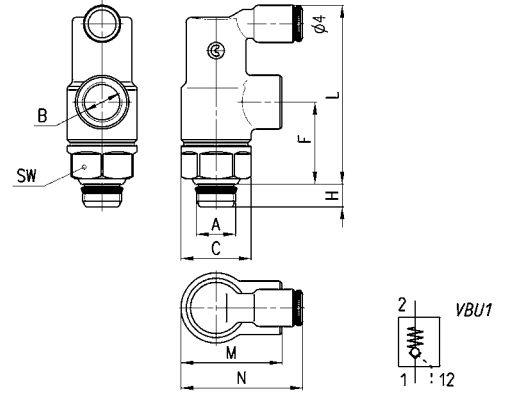

BSP THREADS									
DIMENSIONS (in mm)									
Model	A BSP	B BSP	C	F	H	L	M	N	SW
VBU 1/8	1/8	1/8	16.9	20	5.5	43	24.5	30	15
VBU 1/4	1/4	1/4	20.5	25	7	50	32.2	33.5	19
VBU 3/8	3/8	3/8	26.8	33	8	67	40	39.5	24
VBU 1/2	1/2	1/2	30	45.5	9	85.7	52	48	27

Bidirectional blocking valve BSP Valve

METRIC Tube

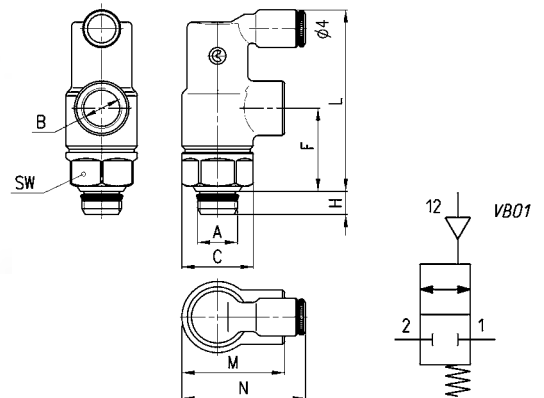

BSP THREADS									
DIMENSIONS (in mm)									
Model	A BSP	B BSP	C	F	H	L	M	N	SW
VBO 1/8	1/8	1/8	16.9	20	5.5	43	24.5	30	15
VBO 1/4	1/4	1/4	20.5	25	7	50	32.2	33.5	19
VBO 3/8	3/8	3/8	26.8	33	8	67	40	39.5	24
VBO 1/2	1/2	1/2	30	45.5	9	85.7	52	48	27

6 Silencers

Exhausting Flow Controls
Series GSCU, GSVU, RSW



Thread Type: NPTF 1/8, 1/4, 3/8
BSP G1/8 - G1/4 - G3/8 - G1/2

Silencers - BSP/Metric
Series 2901, 2903, 2921, 2931, 2938, 2939, RSW



Threaded and Push-In Design: Sintered Bronze, Stainless
Steel Mesh and Polyethylene
Thread Type : M5, M7, G1/8, G1/4, G3/8, G1/2, G3/4, G1

6

SILENCERS

Exhausting Flow Control Series RSW, GMCU, GSCU

6

Threaded and Push-In Design: Sintered Bronze, Stainless Steel Mesh and Polyethylene

Thread Type: M5, M7, G1/8, G1/4, G3/8, G1/2, G3/4, G1



Our silencing flow controllers have been designed as small as possible to enable mounting directly on valves or cylinders. The flow regulation range is wide and gradual, allowing the regulation to be very accurate either at minimum or maximum flow.

Flow rate: determined with inlet supply 6 bar and output to atmosphere.
Noise level: determined through a test which is carried out using a phonometer. Placing the phonometer one meter away from the application at the same height for a period of ten seconds gives an average reading of the noise generated.

GENERAL DATA

Construction	body with male and femalthread
Materials used for body	RSW: brass Nickel-plated brass body, Buna-N seals, Nylon gaskets
Materials used for silencing	Sintered Bronze
Ports	NPTF 1/8, 1/4, 3/8 BSP G1/8 - G1/4 - G3/8 - G1/2

Silencing bushing Series 2905

For flow control valves Model SCO and MCO
(see the section 2/7.05)

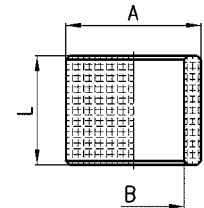

DIMENSIONS (in mm)

Model	A	B	L
2905 1/8	14	10	14.5
2905 1/4	18	13.5	14.5
2905 3/8	21	16.8	14.5

Flow control valves with silencer Series RSW

Flow control valves with silencer.
Ports: G1/8, G1/4, G1/2.

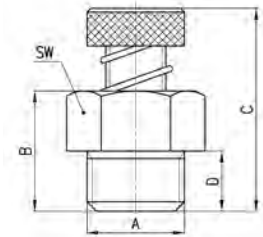
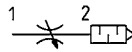

DIMENSIONS (in mm)

Model	A	B	C	D	SW	Q* (NI/min)
RSW 1/8	G1/8	13	22	6	12	410
RSW 1/4	G1/4	16	27	8	16	650
RSW 1/2	G1/2	26	35	11	26	1590

*determined with supply pressure 6 bar with free flow; ensuring screw is open to maximum output.

Exhausting Flow Controls Model GMCU 2905

Meter-out unidirectional exhaust controller for mounting cylinders or valves. It has a manual adjustment with a sintered bronze banjo silencer.

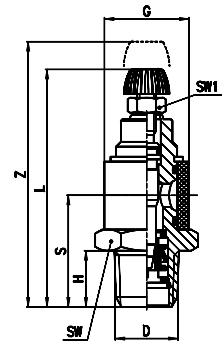
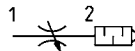

DIMENSIONS (in inches)

Model	D NPTF	G	H	S	L	Z	SW	SW
GMCU 2905-02	1/8	0.551	0.315	0.768	2.031	1.815	0.551	0.276
GMCU 2905-04	1/4	0.709	0.472	0.925	2.224	1.992	0.748	0.276
GMCU 2905-06	3/8	0.827	0.472	0.945	2.610	2.291	0.866	0.394

Exhausting Flow Controls Model GSCU 2905

Meter-out unidirectional exhaust controller for mounting cylinders or valves. It has a screwdriver adjustment with a sintered bronze banjo silencer.

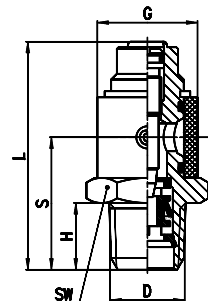
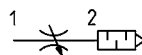

DIMENSIONS (in inches)

Model	D NPTF	G	H	S	L	SW
GSCU 2905-02	1/8	0.551	0.315	0.768	1.449	0.551
GSCU 2905-04	1/4	0.709	0.472	0.925	1.614	0.748
GSCU 2905-06	3/8	0.827	0.472	0.945	1.803	0.866

Silencers - BSP/Metric

Series 2901, 2903, 2921, 2931, 2938, 2939, RSW

6

Threaded and Push-In Design: Sintered Bronze, Stainless Steel Mesh and Polyethylene

Thread Type: M5, M7, G1/8, G1/4, G3/8, G1/2, G3/4, G1



The silencers are indispensable elements for eliminating or reducing the characteristic noise of compressed air during discharge operations. They should always be placed on the outlets of 3/2, 5/2 or 5/3-way valves.

When carrying out maintenance, the silencers should be degreased using mineral spirits and compressed air blown through them in the opposite direction to operation.

Flow rate: determined with inlet supply 6 bar and output to atmosphere.

Noise level: determined through a test which is carried out using a phonometer. Placing the phonometer one meter away from the application at the same height for a period of ten seconds gives an average reading of the noise generated.

GENERAL DATA

Construction	body with male and female thread
Materials used for body	2901 - 2903 - RSW: brass 2921 - 2931: coppering steel 2938 - 2939: polyethylene
Materials used for silencing	2901 - 2903: stainless steel 2921 - 2931 - RSW: bronze (sintered) 2938 - 2939: polyethylene
Ports	M5 - M7 - G1/8 - G1/4 - G3/8 - G1/2 - G3/4 - G1

Silencers Series 2901

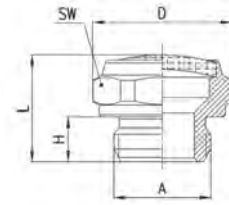

DIMENSIONS (in mm)

Model	A	D	H	L	SW	Max. Oper. Pressure	Flow rate NI/min	Noise db (A)
2901 1/8	G1/8	15.3	5	12	14	10	700	76
2901 1/4-17	G1/4	18.5	6	14	17	10	1000	78
2901 1/4-22	G1/4	23.5	6	15	22	10	1600	80
2901 3/8	G3/8	23.5	7	16	22	10	1500	76
2901 1/2	G1/2	29.5	8	17.5	27	10	3400	86
2901 3/4	G3/4	34	9	20	32	6	4100	87
2901 1	G1	43	11	24.5	40	6	7600	88

Silencers Series 2903

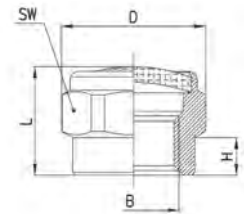

DIMENSIONS (in mm)

Model	B	D	H	L	SW	Max. Oper. Pressure	Flow rate NI/Min	Noise db(A)
2903 1/8	G1/8	15.3	4	11	14	10	700	74

Silencers Series 2921

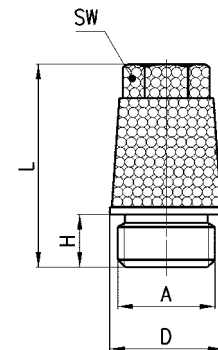

DIMENSIONS (in mm)

Model	A	D	H	L	SW	Max. Oper. Pressure	Flow rate NI/Min	Noise db(A)
2921 1/8	G1/8	12	4.5	21.5	8	10	1730	81
2921 1/4	G1/4	15	6	28	10	10	3300	85
2921 3/8	G3/8	19	8	37	13	10	4250	79
2921 1/2	G1/2	23	9	43.5	15	10	6800	87
2921 3/4	G3/4	30	10	56	19	10	9800	84
2921 1	G1	37	12	67	24	10	10900	86

Silencers Series 2931

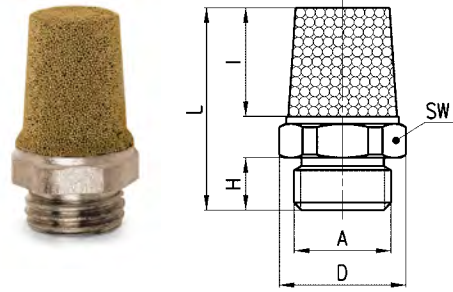

SIL1



DIMENSIONS (in mm)

Model	A	D	H	I	L	SW	Max. Oper. Pressure	Flow rate NI/Min	Noise db (A)
2931 M5	M5	7.7	4	8	16.5	7	10	450	69
2931 M7	M7	9	5	8.5	20	8	10	1130	76
2931 1/8	G1/8	13	4.5	13	21	12	10	1927	88
2931 1/4	G1/4	16.2	6	16.5	27	15	10	3200	86
2931 3/8	G3/8	20	7	23	35.5	19	10	4560	81
2931 1/2	G1/2	24.5	8	28	42	23	10	6800	87
2931 3/4	G3/4	32	9	37	54	30	10	9600	84
2931 1	G1	38.5	11	47	67	36	10	10800	86

Silencers Series 2938



SIL1



Operating temperature:
- 40 / + 80 °C

DIMENSIONS (in mm)

Model	A	D	H	L	Max. Oper. Pressure	Flow rate NI/Min	Noise db (A)
2938 M5	M5	6.5	4.1	23	10	546	67
2938 1/8	G1/8	12.5	5.7	34	10	1441	75
2938 1/4	G1/4	15.5	7	42.5	10	2752	79
2938 3/8	G3/8	18.5	11.5	67.5	10	4735	73
2938 1/2	G1/2	23.5	11	77	10	8534	86

Silencers Series 2939

Operating temperature:
- 40 / + 80 °C



SIL1



* this code can be used on the
Valve Island Series F (see the
section 2/3.16).

DIMENSIONS (in mm)

Model	A	D	H	L	Max. Oper. Pressure	Flow rate NI/Min	Noise db (A)
2939 4	4	7	16	32	10	335	80
2939 6	6	12.5	20.5	45	10	632	79 *
2939 8	8	13.5	21.5	43.5	10	1229	89 *
2939 10	10	15.5	26.5	57.5	10	2650	87 *

7 Tubing

Nylon Tubing
Series 1411



Diameters : OD Inch 1/8", 5/32", 1/4", 5/16", 3/8", 1/2"

DOT Nylon Tubing
Series TEA



Diameters : OD Inch 5/32", 1/4", 3/8", 1/2", 5/8", 3/4"

Polyurethane Tubing
Series 1422



Tubing : Reel Length 100' Feet.
Diameters : OD Inch 1/8", 5/32", 1/4", 5/16", 3/8", 1/2"

Additional Metric Tubing and Accessories



Metric Tubing : Reinforced PVC, Hytrel Polyester, LDPE (Polyethylene), Nylon Coils
Diameter OD/ID: 4/2, 5/3, 6/4, 8/6, 10/8, 12/10, 15/12.5 mm

Nylon Tubing

Inch and Metric, Series 1411, DOT TEA

Diameters: OD Inch (1/8", 5/32", 1/4", 5/16", 3/8", 1/2", 5/8", 3/4")
 OD Metric (4mm, 5mm, 6mm, 8mm, 10mm, 12mm)



TECHNICAL SPECIFICATIONS (Inch)

Material	Nylon 11 (Polyamide)
Melting point	354° ± 4° (flame retardant rating UL-94 HB)
Water absorption (ASTM D-50)	1.1%
Operating pressure	From 0 - 250 psi (See Working Pressure Table)
Bursting pressure	1000 psi
Hardness	78 Rockwell R
Tensile strength at break (D-638)	9500 psi
Elongation at break (D-638)	360 psi
Flexural modulus (D-790)	47,000 psi
Tube diameter	1/8", 5/32", 1/4", 5/16", 3/8", 1/2", 5/8", 3/4"
Fluid	Compressed air [for other types of fluid please contact our engineers]
Operating temperature	-60°F - 180°F * (See Working Pressure Table). Meets UL-94 HB testing requirements.

TECHNICAL SPECIFICATIONS (Metric)

Material	Nylon 11 (Polyamide)
Melting point	354° ± 4° (flame retardant rating UL-94 HB)
Water absorption (ASTM D-570)	1.1%
Operating pressure	From 0 - 250 psi (See working pressure table)
Bursting pressure	1000 psi
Hardness	78 Rockwell R
Tensile strength at break (D-638)	9500 psi
Elongation at break (D-638)	360 psi
Flexural modulus (D-790)	47,000 psi
Tube diameter OD	4, 5, 6, 8, 10, 12 mm
Fluid	Compressed air [for other types of fluid please contact our engineers]
Operating temperature	-60°F - 180°F Meets UL-94 HB testing requirements.

CODING EXAMPLE

1411	04	BL
-------------	-----------	-----------

1411	<p>TYPE 1411 = Nylon 11</p>
04	<p>TUBE DIAMETER OD: 53 = 5/32" 02 = 1/8" 04 = 1/4" 05 = 5/16" 06 = 3/8" 08 = 1/2" 10 = 5/8" 12 = 3/4" 4mm = 4mm 5mm = 5mm 6mm = 6mm 8mm = 8mm 10mm = 10mm 12mm = 12mm</p>
BL	<p>COLOR: BL = Blue BK = Black NT = Natural OR = Orange YL = Yellow RD = Red GR = Green</p>

WORKING PRESSURE

INCH							METRIC						
OD/ID (IN)	Tolerances for OD (IN)	Minimum Bend Radius (IN)	Working Pressure (PSI)				OD/ID (MM)	Tolerances for OD (MM)	Minimum Bend Radius (IN)	Working Pressure (PSI)			
			@75°F	@100°F	@125°F	@150°F				@75°F	@100°F	@125°F	@150°F
1/8 x .093	+ .002 - .003	.375	225	171	148	125	4 x 2.7	+ .05 - .1	.75	275	209	181	151
5/32 x .106	+ .002 - .003	.500	275	209	181	160	5 x 3	+ .05 - .1	1.00	375	285	248	206
1/4 x .180	+ .002 - .004	.875	250	190	165	137	6 x 4	+ .05 - .1	1.50	280	213	185	154
5/16 x .232	+ .002 - .004	1.250	220	170	145	121	8 x 6	+ .05 - .1	2.25	210	160	139	115
3/8 x .275	+ .002 - .004	1.500	220	170	145	128	10 x 8	+ .05 - .1	3.00	180	137	119	99
1/2 x .375	+ .002 - .004	2.000	200	152	133	125	12 x 10	+ .05 - .1	3.50	165	125	109	91

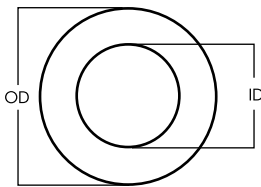

CHEMICAL RESISTANCE

Acids	Good to ph-5
Alkalies	Good to ph-11
Hydrocarbons - aromatic	Excellent
Hydrocarbons - aliphatic	Excellent
Ketones	Excellent
Ethers	Excellent
Esters	Excellent
Alcohols	Good
Salts, neutral	Excellent
Freons	Excellent
Continuous sunlight	Fair
Zinc chloride	Good

Nylon 11 Tubing

INCH Tubing



DIMENSIONS (in inches)			
Model	OD	ID	Reel Length Feet
1411-02_**	1/8	.093	100
1411-53_**	5/32	.106	100
1411-04_**	1/4	.180	100
1411-05_**	5/16	.232	100
1411-06_**	3/8	.275	100
1411-08_**	1/2	.375	100

Note: must indicate choice of color in model number, see key for available choices

Nylon 11 Tubing

METRIC Tubing



DIMENSIONS (in mm)			
Model	OD	ID	Reel Length Feet
1411-4mm_**	4	2.7	100
1411-5mm_**	5	3	100
1411-6mm_**	6	4	100
1411-8mm_**	8	6	100
1411-10mm_**	10	8	100
1411-12mm_**	12	10	100

Note: must indicate choice of color in model number, see key for available choices

DOT Tubing Model TEA

Color : Black

Meets SAE Specification J844, J1131, J2494-3 and DOT-FMVSS 106

INCH Tubing



DIMENSIONS (in inches)

Model	Outer Diameter	Inner Diameter	Minimum Burst Pressure (psi)	Weight (lb./100ft)	Bend radius (inches)	Length (feet)
TEA 53-BK-PA-1000FT	5/32	.092	1200	.56	1/2	1000
TEA 53-BK-PA-100FT	5/32	.092	1200	.56	1/2	100
TEA 04-BK-PA-1000FT	1/4	.170	1200	1.19	1	1000
TEA 04-BK-PA-100FT	1/4	.170	1200	1.19	1	100
TEA 06-BK-PA-500FT	3/8	.251	1400	2.8	1.5	500
TEA 06-BK-PA-100FT	3/8	.251	1400	2.8	1.5	100
TEA 08-BK-PA-500FT	1/2	.376	950	3.8	2	500
TEA 08-BK-PA-100FT	1/2	.376	950	3.8	2	100
TEA 10-BK-PA-250FT	5/8	.441	900	7	2.5	250
TEA 10-BK-PA-50FT	5/8	.441	900	7	2.5	50
TEA 12-BK-PA-250FT	3/4	.566	800	8.6	3	250
TEA 12-BK-PA-50FT	3/4	.566	800	8.6	3	50

Polyurethane Tubing Inch and Metric, Series 1422

Tubing : Reel Length 100' Feet.
 Diameters: OD Inch (1/8", 5/32", 1/4", 5/16", 3/8", 1/2")
 OD Metric (4mm, 6mm, 8mm, 10mm, 12mm)

7

TUBING



Tube Diameter OD 1/8", 5/32", 1/4", 5/16", 3/8", 1/2"
 Reel Length 100 feet

Metric Tube Diameter OD 4, 6, 8, 10, 12 mm
 Reel Length 100 feet

Meets UL-94 HB testing requirements.

Complies with NSF61 standard.

TECHNICAL SPECIFICATIONS - INCH

Material	Polyurethane (Ether Based), PUR 95A
Vacuum rating	to 28" Hg
Operating pressure	From 0 - 230 psi (See Working Pressure Table)
Bursting pressure	690 psi
Hardness	95 Shore A
Tube diameter	1/8", 5/32", 1/4", 5/16", 3/8", 1/2"
Fluid	Compressed air [for other types of fluid please contact our engineers]
Operating temperature	-40°F - 165°F

TECHNICAL SPECIFICATIONS - METRIC

Material	Polyurethane (Ether Based), PUR 95A
Vacuum rating	to 28" Hg
Operating pressure	From 0 - 180 psi (See Working Pressure Table)
Bursting pressure	540 psi
Hardness	95 Shore A
Tube diameter	4, 6, 8, 10, 12 mm
Fluid	Compressed air [for other types of fluid please contact our engineers]
Operating temperature	-40°F - 165°F

CODING EXAMPLE

1422	04	RD
-------------	-----------	-----------

1422 TYPE
1422 = Polyurethane (95A)

04 TUBE DIAMETER OD:
02 = 1/8"
04 = 1/4"
05 = 5/16"
06 = 3/8"
08 = 1/2"
53 = 5/32"
4mm = 4mm
6mm = 6mm
8mm = 8mm
10mm = 10mm
12mm = 12mm

BL COLOR:
BL = Blue
BK = Black
CL = Clear
OR = Orange
YL = Yellow
RD = Red
GR = Green

WORKING PRESSURE

OD/ID (IN)	Tolerances for OD (IN)	Minimum Bend Radius (IN)	INCH			
			Working Pressure (PSI)			
			@75°F	@100°F	@125°F	@150°F
1/8 x .066	±.005	1/4	233	172	140	116
5/32 x 3/32	±.005	3/8	176	130	106	88
1/4 x .160	±.005	1/2	148	110	89	74
5/16 x .216	±.005	3/4	150	111	90	75
3/8 x .245	±.005	7/8	147	109	88	74
1/2 x .320	±.005	1 1/8	140	104	84	70

OD/ID (MM)	Tolerances for OD (MM)	Minimum Bend Radius (IN)	METRIC			
			Working Pressure (PSI)			
			@75°F	@100°F	@125°F	@150°F
4 x 2.4	±.127	3/8	176	130	106	88
6 x 4	±.127	1/2	145	107	87	73
8 x 5	±.127	3/4	155	115	93	78
10 x 6.5	±.127	7/8	149	110	89	75
12 x 8	±.127	1 1/8	133	100	80	67

OD/ID and Hardness Comparison

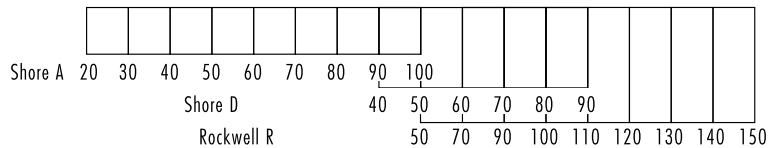
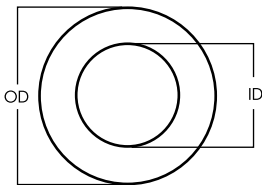

Polyurethane Tubing

INCH Tubing



DIMENSIONS (in inches)			
Model	OD	ID	Reel Length Feet
1422-02_**	1/8	.066	100
1422-04_**	1/4	.160	100
1422-05_**	5/16	.216	100
1422-06_**	3/8	.245	100
1422-08_**	1/2	.320	100
1422-53_**	5/32	3/32	100

Note: must indicate choice of color in model number, see key for available choices

Polyurethane Tubing

METRIC Tubing



DIMENSIONS (in mm)			
Model	OD	ID	Reel Length Feet
1422-4mm_**	4	2.4	100
1422-6mm_**	6	4	100
1422-8mm_**	8	5	100
1422-10mm_**	10	6.5	100
1422-12mm_**	12	8	100

Note: must indicate choice of color in model number, see key for available choices

Additional Metric Tubing and Accessories

7

Metric Tubing : Reinforced PVC, Hytrel Polyester, LDPE (Polyethylene), Nylon Coils
Diameter OD/ID: 4/2, 5/3, 6/4, 8/6, 10/8, 12/10, 15/12.5 mm

TUBING

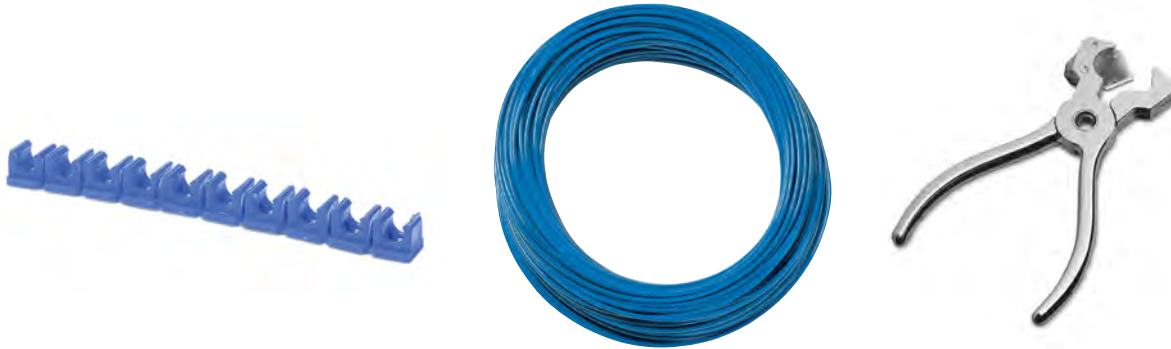

Camozzi offers a range of alternate metric tubes and spirals with specific features which are suitable for several technical requirements. Thanks to high-quality raw materials and with a low specific weight, these products are very small and lightweight. They also show high resistance against stress and flexural vibrations.

The smooth internal surfaces for the fluid passage (roughness of about 6 micron) reduces friction in the air line for greater flow. Technopolymers used are particularly resistant to aging, thus ensuring long product life.

Hardness Comparison

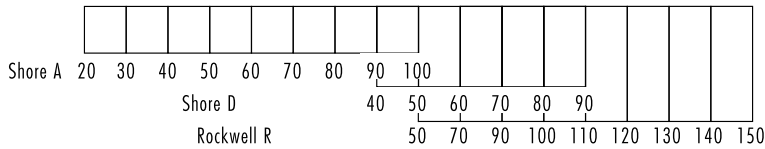

Tubes Model PV

Tube in reinforced PVC

Color: Blue



Model	D/d	Max pressure (bar) at 20 C°	Weight (g/m)	Bend radius (mm)	Lot (m)
PV 6/4	6/4	40	21.8	50	
PV 8/6	8/6	40	23.3	60	
PV 10/8	10/8	35	35.3	65	
PV 12/10	12/10	28	51	80	
PV 15/12.5	15/12.5	28	69	90	

Tubes Model TRH

Tube in Hytrel polyester

Color (standard): Blue
Colors available on request:
Red - Green - Black - Yellow - White



Model	D/d	Max pressure (bar) at 23 C°	Weight (g/m)	Bend radius (mm)	Lot (m)
TRH 4/2-Z	4/2	32	96	11.5	16
TRH 5/3-Z	5/3	27	80	15.3	25
TRH 6/4-Z	6/4	21	64	19.2	35
TRH 8/6-Z	8/6	15	44	26.8	65
TRH 10/8-Z	10/8	12	36	34.5	100
TRH 12/10-Z	12/10	10	30	42.1	125

Tubes Model TPE

Tube in low density polyethylene

Colors: neutral, Blue



Model	D/d	Max pressure (bar) at 23 C°	Weight (g/m)	Bend radius (mm)	Lot (m)
TPE 5/3	5/3	17	50	11.3	23
TPE 6/4	6/4	13	40	14.1	32
TPE 8/6	8/6	10	30	19.8	43
TPE 10/8	10/8	7	22	25.4	76

Tubes Model TSP

Spiral in Rilsan®

Color: Blue (other colors available on request)



Model	D/d	max pressure (bar) at 20°C	External Ø	Length (closed), mm	Max length, meters
TSP 6/4	6/4	28	64	1000	15
TSP 8/6	8/6	20	86	1000	15
TSP 10/8	10/8	16	102	1050	15
TSP 12/10	12/10	12	126	1050	15

Plastic tubes cutter Model PNZP-12



Model	
PNZP-12	able to cut tubes with \emptyset till to 12 mm

Tubes clamps Model MPL

Plastic tubes clamps

Color: Blue

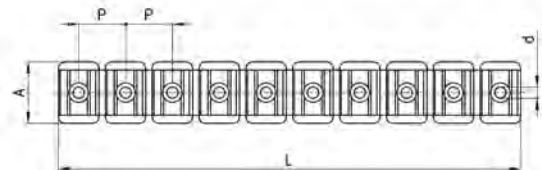

Model	\emptyset Tube	L	A	d	P	Nr of positions
MPL-4	4	115	19	2.5	11.5	10
MPL-6	6	115	19	2.5	11.5	10
MPL-8	8	144	19	3.5	14.5	10
MPL-10	10	172	19	4.5	17.5	10
MPL-12	12	78	19	4.5	20	4

Tubes cutters Model PNZ

Small and large tubes cutter



Model		Replacement Blade
PNZ-12	able to cut tubes with \emptyset up to 12 mm (1/2")	LAME X PNZ-12
PNZ-25	able to cut tubes with \emptyset up to 25 mm (1")	LAME X PNZ-25

Model RT - Metallic Tubing Scribing Tool

For high pressure applications with stainless steel or metallic tubing up to 1200 psi, so long as the tubing is cut and scored according to the procedures and tool geometry provided by Camozzi Pneumatics, Inc. To be used with Camozzi 6000 Series brass fittings and collets ONLY.

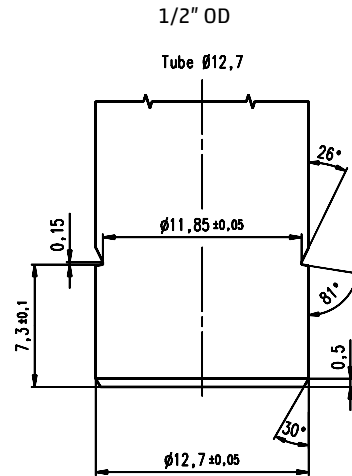
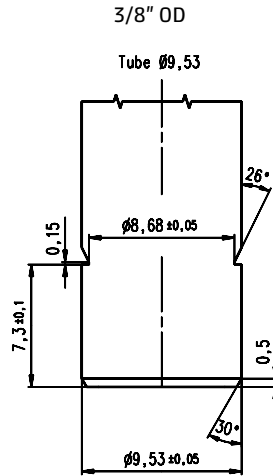
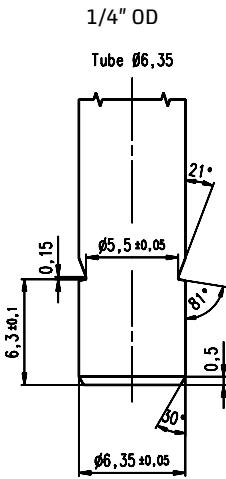

Final groove dimensions above are for checking depth and length of final groove made on metallic tubes.

Model	Tubing Sizes Served	Spare Roller Cutting Wheel
6RT 04	1/4" - 6mm - 8mm OD	RRT 6-8
6RT 06-08	3/8" - 1/2" - 10mm - 12mm OD	RRT 9.53-12.7

Tubing Chemical Resistance Data

The following ratings are very general guidelines, designed ONLY to be used as an initial screening tool. Bear in mind that dynamic vs. static application, temperature, chemical mixtures, and the specific tubing compound selected can significantly affect or change these ratings either positively or negatively. Careful testing under actual conditions is essential. Accuracy for these ratings is not given or implied.

N = Nylon
 PUR = Polyurethane
 PE = Polyethylene
 PVC = Polyvinylchloride (vinyl)

RATINGS:
 SOLVENT/CHEMICAL
 1 = little or no effect
 2 = minor effect
 3 = moderate effect
 4 = severe effect
 - = no tested data available

SOLVENT/CHEMICAL	N	P U	P R	P E	P V	SOLVENT/CHEMICAL	N	P U	P R	P E	P V	SOLVENT/CHEMICAL	N	P U	P R	P E	P V	SOLVENT/CHEMICAL	N	P U	P R	P E	P V
Acetic Acid	-	4	1	4		Butter	-	1	-	-		Green Sulfate Liquor	-	1	-	-		Potassium Acetate (aq)	-	4	-	-	
Acetic Acid 30%	-	4	1	4		Butyl Alcohol	3	4	1	2		Hexane	-	2	3	2		Potassium Chloride (aq)	-	1	1	1	
Acetone	-	4	2	4		Butylene	-	4	1	1		Hydraulic Oil	-	1	1	1		Potassium Cyanide (aq)	-	1	1	1	
Acetylene	-	4	1	1		Calcium Chloride (aq)	1	1	2	1		Hydrochloric Acid (cold) 37%	-	4	2	2		Potassium Hydroxide (aq)	3	4	1	1	
Alkazene	-	4	-	-		Calcium Hydroxide (aq)	-	1	2	1		Hydrochloric Acid (hot) 37%	-	4	-	-		Producer Gas	-	1	1	1	
Aluminum Chloride (aq)	-	3	2	1		Calcium Nitrate (aq)	1	1	-	-		Hydrochloric Acid (cold)	-	3	-	-		Propane	1	3	3	1	
Aluminum Nitrate (aq)	-	3	-	-		Calcium Sulfide (aq)	-	1	-	-		Hydrochloric Acid (hot)	-	4	-	-		Propyl Alcohol	-	4	-	-	
Ammonia Anhydrous	-	4	2	1		Cane Sugar Liquors	-	4	-	1		Hydrogen Gas	1	1	1	1		Propylene	-	4	-	-	
Ammonia Gas (cold)	-	3	-	-		Carbolic Acid	-	3	2	3		Isobutyl Alcohol	-	4	-	-		Propylene Oxide	-	4	-	-	
Ammonia Gas (hot)	-	4	-	-		Carbon Dioxide	-	1	3	1		Isooctane	-	2	-	-		"Pydraul, 10E, 29 ELT"	-	4	-	-	
Ammonium Chloride (aq)	-	1	1	1		Carbonic Monoxide	-	1	2	1		Isopropyl Acetate	-	4	2	4		"Pydraul, 30E, 50E, 65E"	-	4	-	-	
Ammonium Sulfate (aq)	-	1	1	1		Carbon Tetrachloride	3	4	2	2		Isopropyl Alcohol	1	3	-	-		"Pydraul, 115E"	-	4	-	-	
Amyl Alcohol	-	4	2	1		Castor Oil	-	1	-	1		Isopropyl Ether	-	2	1	2		"Pydraul, 23DE, 312C, 540C"	-	4	-	-	
Amyl Naphthalene	-	4	-	-		Chlorine (dry)	4	4	2	1		Kerosene	1	1	3	4		Rapseed Oil	-	2	-	-	
Animal Fats	-	1	-	-		Chlorine (wet)	4	4	-	-		Lacquers	-	4	2	3		Red Oil (MIL-H-5808)	-	1	-	-	
Aqua Regia	-	4	2	3		Chloroform	3	4	3	4		Lacquer Solvents	-	4	2	3		RJ-1 (MIL-F-23338 0)	-	1	-	-	
Arsenic Acid	-	3	2	1		Chlorox	-	4	-	-		Lard	-	1	2	1		RP-1 (MIL-F-25578 C)	-	1	-	-	
Asphalt	-	2	1	1		Chromic Acid	4	4	1	1		Lavender Oil	-	4	-	-		Salt Water	1	2	1	1	
ASTM Fuel A	-	2	-	-		Citric Acid	1	1	1	2		Lead Acetate (aq)	-	4	1	1		Sewage	-	1	2	1	
ASTM Fuel B	-	3	-	-		Coal Tar	-	3	-	-		Linseed Oil	1	2	3	1		Silicate Esters	-	1	-	-	
ASTM Fuel C	-	3	1	1		Coconut Oil	-	2	-	1		Liquefied Petroleum Gas	-	-	-	-		Silicone Oils	-	1	1	1	
Barium Chloride (aq)	-	1	1	1		Cod Liver Oil	-	1	-	1		Lubricating Oils	-	2	4	2		Silver Nitrate	-	1	2	1	
Beer	1	2	1	1		Coke Oven Gas	-	4	-	-		Lye	-	4	-	-		Skydrol 500	-	4	-	-	
Beet Sugar Liquors	-	4	1	1		Copper Chloride (aq)	-	1	2	1		Magnesium Chloride (aq)	1	1	1	1		Skydrol 700	-	4	-	-	
Benzene	1	3	3	3		Copper Cyanide (aq)	-	1	2	1		Magnesium Hydroxide (aq)	-	4	1	1		Soap Solutions	1	3	3	1	
Benzine	-	2	-	-		Corn Oil	-	1	3	2		Mercury	1	1	1	2		Sodium Chloride (aq)	1	1	1	1	
Blast Furnace Gas	-	4	-	-		Cotton Seed Oil	-	1	2	2		Methane	1	3	-	-		Sodium Hydroxide (aq)	2	4	2	1	
Bleach Solutions	-	4	-	1		Creosol	4	4	3	4		Methyl Acetate	1	4	2	4		Sodium Peroxide (aq)	-	4	1	2	
Borax	-	1	1	2		Cyclohexane	1	1	2	4		Methyl Acrylate	-	4	-	-		Sodium Phosphate (aq)	-	1	-	-	
Boric Acid	-	1	1	1		Denatured Alcohol	-	4	-	-		Methyl Alcohol	1	4	1	1		Sodium Sulfate (aq)	-	1	1	1	
Brake Fluid	-	4	-	-		Detergent Solution	-	4	1	1		Methyl Butyl Ketone	-	4	-	1		Soy Bean Oil	-	2	1	1	
Brine	-	2	4	3		Diesel Oil	-	3	3	1		Methyl Chloride	3	4	3	4		Steam (Below 300°F)	4	4	-	-	
Bromine Water	4	4	-	-		Dioxane	-	4	-	-		Methylene Chloride	-	4	3	4		Steam (Above 300°F)	4	4	-	-	
Bunker Oil	-	2	-	-		Dowtherm Oil	-	3	-	-		Methyl Ethyl Ketone	1	4	2	4		Stoddard Solvent	-	1	3	3	
Butane	1	1	3	3		Dry Cleaning Fluids	-	4	-	-		Methyl Isobutyl Ketone	1	4	-	-		Styrene	-	3	-	4	
						Ethane	-	3	-	4		Milk	1	4	1	1		Sucrose Solution	-	4	-	-	
						Ethyl Acrylate	-	4	-	-		Mineral Oil	1	1	2	1		Sulfuric Acid (concentrate)	-	4	3	4	
						Ethyl Alcohol	3	4	-	-		Naphtha	1	2	1	3		Sulfuric Acid (dilute)	-	3	1	1	
						Ethyl Benzene	-	4	-	-		Naphthalene	1	2	1	4		Sulfuric Acid (20% oleum)	-	4	-	-	
						Ethyl Cellulose	-	2	-	-		Natural Gas	-	2	-	-		Sulfurous Acid	-	3	2	1	
						Ethyl Chloride	-	2	-	-		Nitric Acid (concentrate)	4	4	3	4		Tannic Acid	-	1	2	1	
						Ethyl Ether	-	3	-	-		Nitric Acid (dilute)	4	3	-	4		Tetrochloroethylene	-	4	2	4	
						Ethyl Chloride	-	4	3	4		Nitroethane	-	4	-	-		Toluene	1	4	3	4	
						Ethyl Glycol	2	4	1	1		Nitrogen	-	1	-	-		Transformer Oil	-	1	-	-	
						Ethylene Oxide	1	4	3	3		N-Octane	-	4	-	-		Transmission Fluid Type A	-	1	-	-	
						Ethylene Trichloride	-	4	-	-		Oleic Acid	1	2	3	3		Trichloroethane	3	4	-	3	
						Ferric Chloride (aq)	-	1	1	1		Oleum Spirits	-	3	4	4		Trichloroethylene	3	4	3	4	
						Ferric Nitrate (aq)	-	1	2	1		Olive Oil	-	1	1	3		Turbine Oil	-	1	3	1	
						Ferric Sulfate (aq)	-	1	1	1		Oxygen (cold)	1	1	-	-		Turpentine	1	4	3	2	
						Flourine (liquid)	4	4	3	4		Oxygen (200°-400°F)	-	4	-	-		Varnish	-	3	3	4	
						Formaldehyde (RT)	-	4	3	1		Paint Thinner, "Duco"	-	4	-	-		Vinegar	1	4	2	1	
						Formic Acid	3	3	2	1		Perchloric Acid	-	4	-	-		Vinyl Chloride	-	4	-	-	
						Freon 11	-	4	3	1		Perchloroethylene	3	4	4	3		Water	1	1	1	1	
						Freon 12	1	1	3	1		Petroleum (Below 250°F)	-	2	-	-		"Whiskey, Wines"	1	2	3	1	
						Freon 22	1	4	-	2		Petroleum (Above 250°F)	4	4	-	-		White Oil	-	1	-	-	
						Fuel Oil	-	2	3	1		Phenol	4	3	2	3		Wood Oil	-	3	-	-	
						Furtural Glucose	-	4	1	1		Phenyl Ethyl Ether	-	4	-	-		Xylene	2	4	3	4	
						Glue	-	1	1	3		Phosphoric Acid 45%	2	1	2	2		Zinc Acetate (aq)	-	4	-	-	
						Glycerin	1	1	1	1		Pickling Solution	-	4	-	-		Zinc Chloride (aq)	1	1	1	1	
						Glycols	1	4	-	-		Ploric Acid	3	2	-	4							

TUBING

7

8 Technical Data

Nickel Plating Corrosion Chart

Nickel Plating Corrosion Chart for Foods

Tubing Chemical Resistance

General Pipe Identification

Pipe Thread Standards

Hybrid Threading Torque Specifications

Fitting O-Ring Replacement Guide

Marketing Materials

Custom Fitting & Flow Control Production

Corrosion Resistance of Electrolytic Nickel Plating for Chemicals

LEGEND:

- A: Very satisfactory result, rate of removal from corrosion less than 2.5 microns per year.
 - B: Useful result, rate of removal from corrosion less than 12.5 microns per year.
 - C: To be decided in each case individually, rate of removal from corrosion less than 25 microns per year.
 - D: Application not recommended for long periods, rate of removal from corrosion more than 25 microns per year.
- Camozzi fittings are plated at a thickness of 5-8 µm (microns).

8

TECHNICAL DATA

Substance	% Concentration	Temp. Deg.C	Resistance
Acetic Acid	0-70	Ambient	B-C
Acetone	100	54	A-B
Acidic Well-Water	-	20-4	B
Aliphatic Acid	100	Ambient	B
Aluminum Chloride	saturated	Ambient	D
Aluminum Sulphate	saturated	Ambient	B
Ammonium Chloride	saturated	Ambient	B
Ammonium Hydroxide	5-28	Ambient	C
Ammonium Nitrate	saturated	Ambient	B
Amyl Alcohol	100	Ambient	A
Amyl Chloride	100	Ambient	A
Aviation Gasoline	100	Ambient	A
Barium Chloride	2-40	Ambient	A
Barium Hydroxide	2-50	60	A
Beer	-	10	A
Benzil Acid	saturated	Ambient	D
Benzyl	100	Ambient	A
Boiling Oil	100	Ambient	A
Borax	saturated	Ambient	B
Boric Acid	saturated	Ambient	C
Bromine	100	Ambient	B
Butane	100	25	A
Butyl Alcohol	100	Ambient	A
Calcium Chloride	saturated	Ambient	A
Calcium Hydroxide	saturated	60	A
Calcium Nitrate	saturated	Ambient	A
Carbon Dioxide	100	Ambient	B
Carbon Tetrachloride	100	@ boiling point	A
Chlorine	100	Ambient	B
Chloroform	100	@ boiling point	B
Chloroform	100	Ambient	A
Chromic Acid	2-100	Ambient	D
Citric Acid	5	Ambient	A
Coal Oil	100	Ambient	A
Coffee		@ boiling point	A
Copper Chloride	saturated	Ambient	D
Copper Nitrate	saturated	Ambient	D
Copper Sulphate	2-30	Ambient	C
Crude Oil	100	Ambient	A
Dichloro Ethylene	100	@ boiling point	A
Dichloro Ethynol	100	Ambient	A
Dimethyl Benzol	100	Ambient	A
Distilled Water		Ambient	A
Drinkable Water		80	A
Dry Chlorine	100	Ambient	A
Ethyl Acid	100	Ambient	A
Ethylene	100	Ambient	A
Ethylic Glycol	100	Ambient	A
"Exhaust Gas, Basic"		260	D
"Exhaust Gas, Oxidative"		540	A
Ferrous Chloride	saturated	Ambient	D
Ferrous Nitrate	saturated	Ambient	D
Ferrous Sulphate	saturated	Ambient	D
Formaldehyde	37	Ambient	B
Formic Acid	88	Ambient	B
Fruit Juice		Ambient	A
Gas	100	Ambient	A
Glucose	saturated	Ambient	A
Glycerine	100	Ambient	A
Hydrochloric Acid	30	Ambient	D
Hydrochloric Acid	conc.	Ambient	D
Hydrochloric Acid	10	Ambient	D
Hydrochloric Acid	20	Ambient	D
Hydrofluoric Acid	2-100	Ambient	D
Hydrogen Sulphide	100	Ambient	A
Iron Chloride	saturated	Ambient	D
Kerosene	100	Ambient	A
Lactic Acid	85	Ambient	A
Lactic Acid	10-50	Ambient	C

Substance	% Concentration	Ambient Temp. Deg.C	B Resistance
Lead Acetate	saturated	Ambient	A
Lead Nitrate	saturated	Ambient	A
Linseed Oil	100	Ambient	A
Lithium Chloride	saturated	Ambient	A
Magnesium Chloride	2-50	Ambient	A
Magnesium Hydroxide	2-50	Ambient	A
Molasses		100	B
Molasses		Ambient	A
Methyl Alcohol	100	Ambient	A
Methyl Chloride	100	Ambient	C
Milk		Ambient	A
Mineral Oil	100	Ambient	A
Natural Resin	100	50	A
Nickel Chlorine	saturated	Ambient	C
Nickel Sulphate	saturated	Ambient	C
Nitric Acid	2-100	Ambient	D
Oleic Acid	100	Ambient	A
Oleum	20	Ambient	D
Orange Juice		Ambient	A
Oxalic Acid	saturated	Ambient	A
Palm Oil	100	Ambient	A
Paraffin	100	Ambient	A
Peanut Oil	100	Ambient	A
Phenol	100	90	A
Phosphoric Acid	0-100	Ambient	0-10% C 10-80 % B
Picric Acid	100	Ambient	D
Polymers	100	20...200	A
Potassium Carbonate	saturated	Ambient	A
Potassium Chloride	saturated	Ambient	A
Potassium Hydrate	2-50	Ambient	A
Potassium Ironcyanide	saturated	Ambient	B
Propane	100	Ambient	A
Rosin	100	@ boiling point	A
Sea Water		Ambient	A
Silver Chloride	saturated	Ambient	D
Soap		95	A
Sodium Bicarbonate	saturated	Ambient	B
Sodium Carbonate	saturated	Ambient	A
Sodium Chloride	saturated	Ambient	A
Sodium Cyanide	5	Ambient	B
Sodium Hydrate	2-73	>=60	A
Sodium Nitrate	10	Ambient	A
Sodium Phosphate	saturated	Ambient	A
Sodium Sulphate	saturated	Ambient	A
Sodium Sulphide	saturated	Ambient	A
Steam		425	A
Steam Condensate		80	A
Stearic Acid	saturated	Ambient	A
Sulphuric Acid	20	Ambient	C
Sulphuric Acid	50-70	Ambient	C
Sulphuric Acid	30-40	Ambient	C
Sulphuric Acid	90	Ambient	C
Sulphuric Acid	10	Ambient	D
Sulphuric Acid	80	Ambient	D
Sulphuric Acid	100	Ambient	D
Sulphurous Acid	2-60	Ambient	D
Tanning Solution	100	Ambient	A
Toluol	100	95	A
Trichlorethylene	100	95	A
Turpentine	100	Ambient	A
Urine	saturated	Ambient	A
Vinegar	100	Ambient	B
Vinyl Chloride	100	35	A
Whiskey		Ambient	A
Wine	100	Ambient	A
Zinc Chloride	saturated	Ambient	B
Zinc Nitrate	saturated	Ambient	B

Corrosion Resistance of Electrolytic Nickel Plating for Foods

LEGEND:

- Very satisfactory result, rate of removal from corrosion less than 2.5 microns per year.
- Useful result, rate of removal from corrosion less than 12.5 microns per year.
- To be decided in each case individually, rate of removal from corrosion less than 25 microns per year.
- Application not recommended for long periods, rate of removal from corrosion more than 25 microns per year.

Camozzi fittings are plated at a thickness of 5-8 µm (microns).

8

TECHNICAL DATA

Substance	pH Value	Test Volume (ML)	Test Time (HRS)	Penetration (microns/yr)
Apple Juice	3.1	850	1702	1.2
Bean Soup		500	1702	0.7
Canadian Whiskey	5.2	150	3910	1.6
Canned Corn	6.2	250	1702	0.7
Canned Peaches	3.5	400	1681	0.2
Canned Peas	6.1	450	1702	0.2
Canned Pineapple		500	1681	0.3
Canned Potatoes	5.8	350	1681	1.9
Cherry	3.8	150	3910	6.4
Chicken Broth	6	200	312/502	1
(3 tests @ 95 degrees C)				
Chocolate Candy		250	1681	
Coffee	5.3	700	1729	9.9
Coffee	4.8	200	312/554	4.7
(4 tests @ 95 degrees C)				
Cooked Onions		450	1702	0.8
Cranberry Juice		950	1702	0.5
Eggs	8.3	300	1248/1633	0.2
(2 tests @ 2 degrees C)				
Gin (2 tests)	7.5	150	3910	0.02
Grape Juice	4	800	1702	1.8
Grapefruit Juice	3.2	900	1702	0.5
Lemon Juice	2.3	800	1702	1
Lemonade		950	1702	11.4
Molasses		350	1702	0.2
Margarine (2 degrees C)		200	1633	
Mayonnaise	3.7	470	1681	0.2
Meat Gravy		400	16581	0.6
Milk	6.4	950	1248/1633	0.04
(2 tests @ 2 degrees C)				
Mushroom Soup		250	1702	0.3
Mushrooms		150	1681	0.6
Peanut Butter		450	1702	
Peeled Tomatoes	4.2	400	1681	0.5
Plum Juice		1000	1702	1
Pork and Beans	5.5	350	1681	0.3
Quark Cheese		300	1248/1633	0.4
(2 tests @ 2 degrees C)				
Rum	5.8	150	3910	0.2
Sardines in Soybean Oil		30 (oil)	1681	
Scotch Whiskey	5.3	150	3910	1.8
Sliced Radishes	5.2	400	1681	1.8
Sour Kraut	3.5	150	1681	4.4
Spanish Olives	3.7	250	1702	0.3
Tea	2.6	750	1729	4.2
Tea	2.6	200	312/554	9
(4 tests @ 95 degrees C)				
Tequila (2 tests)	4.8	150	3910	0.4
Tomato Juice (2 tests)	4.2	710	1321/1336	0.5
Tomato Soup		250	1702	0.5
Tomato Soup	3	200	502	6.1
(2 Tests @ 95 degrees C)				
Tropical Punch		950	1702	1.3
Vegetable Oil		470	1729	
Vegetable Soup		250	1702	1.2
Vinegar	2.9	470	1729	7
Vodka	8.2	150	3910	

Substance	Test Volume (ML)	Test Time (HRS)	Penetration (microns/yr)
Acacia 1%, 4.4 pH	500	5570	0.2
Acetic Acid, 5% CH3COOH (2 tests)	500	2616	13.7
Alum, 5% (Al2SO4) 3	450	1609	4.3
Ammonia, 28% NH4OH	500	3624	12.6
Asorbic Acid, 10% C4H6O5	500	2660	16.7
Asorbic Acid, 5% C6H8O6	500	4990	6.6
Carbon Dioxide, 5% Fenol	450	4891	4.3
Citric Acid, 5% C6H8O7	500	2660	14.7
Deionized Water, (2 tests @ 95 degrees C)	200	211	
Deionized Water, (1MΩ-cm% tests)	900	4536/5089	1.9
Dextrine, 1%, 3.8 pH	500	5570	0.1
Drinkable Water, 8.0 pH (4 tests)	900	4536/5089	0.05
Fecula, 1%	500	3839	0.5
Lactic Acid, 85% C3H6O3	500	1337	1.3
Phosphoric Acid, 1% H3PO4 (2 tests)	450	2599/2618	12.6
Potassium Carbonate, 450 25% K2CO2	2302	0.2	
Saline Water, 26% NaCl (2 tests)	450	1337/3478	2
Saline Water, 40% CaCl2 (2 tests)	450	1198/3335	0.1
Salt, 5% NaCl, 6.3 pH	450	1198	0.5
Sea Water, Artificial, 8.2 pH (2 tests)	500	1272	1
Sodium Bicarbonate, 2% NaHCO3	500	3839	6.4
Sodium Hydroxide, 1% NaOH	500	5042	0.2
Sodium Hypochlorite, 1% NaOCl	450	460	0.5
Sodium Nitrate, 42% NaNO2	450	574	12
Sodium Nitrate, 47% NaNO3	450	1198	
Water, 700mg/1CO2, 3.9 pH (2 tests)	450	404	7.9

General Pipe Thread Identification Guide

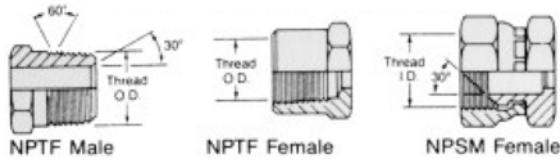

IPT or NPT Pipe Thread

The NPTF (IPT) male will mate with the NPTF or NPSM female. The NPTF (IPT) male has tapered threads and a 30° inverted seat. The NPTF female has tapered threads and no seat. The seal takes place by deformation of the threads. The NPSM female has straight threads and a 30° inverted seat. The seal takes place on the 30° seat.

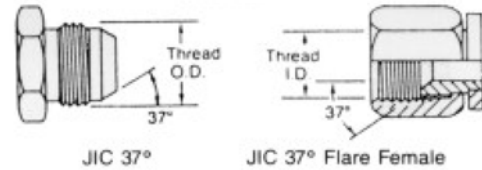

JIC 37-degree Flare

The JIC 37° flare male will mate with a JIC female only. The JIC male has straight threads and a 37° flare seat. The JIC female has straight threads and a 37° flare seat. The seal is made on the 37° flare seat.

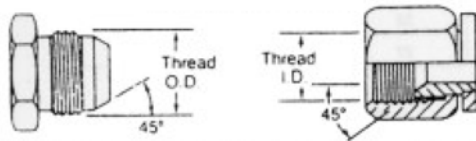

SAE 45-degree Flare

The SAE 45° flare male will mate with an SAE 45° flare female only. The SAE male has straight threads and a 45° flare seat. The SAE female has straight threads and a 45° flare seat. The seal is made on the 45° flare seat.

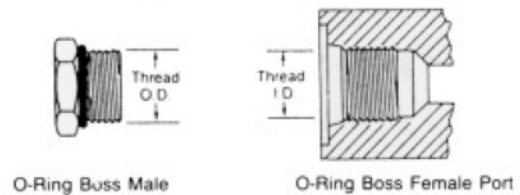

SAE Straight Thread O-Ring Boss

The o-ring boss male will mate with an o-ring boss female only. The female is generally found on equipment ports. The male has straight threads and an o-ring. The female has straight threads and a sealing face. The seal is made at the o-ring on the male and the sealing face on the female.

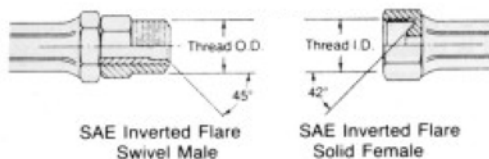

SAE Inverted Flare

The SAE 45° inverted flare male will mate with a 42° inverted flare female only. The male has straight threads and a 45° inverted flare. The female has straight threads and a 42° inverted flare. The seal is made on the 45° flare seat on the male and the 42° flare seat on the female.

National Pipe Thread Standard

Thread Form

The taper on NPT threads allows them to form a seal when torqued as the flanks of the threads compress against each other, as opposed to straight thread fittings or compression fittings in which the threads merely hold the pieces together and do not provide the seal. However a clearance remains between the crests and roots of the threads, resulting in a leakage around this spiral. This means that NPT fittings must be made leak free with the aid of thread seal tape or a thread sealant compound. (The use of tape or sealant will also help to limit corrosion on the threads, which can make future disassembly nearly impossible.)

There is also a semi-compatible variant called NPTF or Dryseal, designed to provide a more leak-free seal without the use of Teflon tape or other sealant compound. NPTF threads are the same basic shape but with crest and root heights adjusted for an interference fit, eliminating the spiral leakage path.

Sometimes NPT threads are referred to as MPT (Male Pipe Thread), MNPT, or NPT (M) for male (external) threads and FPT (Female Pipe Thread), FNPT, or NPT (F) for female (internal) threads. An equivalent designation is MIP (Male iron pipe) and FIP (Female iron pipe).

PIPE THREAD SIZES

Nominal NPT Size	Outer Diameter	Threads per inch	Pitch of Thread
1/16"	0.3125"	27	0.03704
1/8 "	0.405"	27	0.03704
1/4 "	0.540"	18	0.05556
3/8 "	0.675"	18	0.05556
1/2 "	0.840"	14	0.07143
3/4 "	1.050"	14	0.07143
1 "	1.315"	11½	0.08696
1¼ "	1.660"	11½	0.08696
1½ "	1.900"	11½	0.08696
2 "	2.375"	11½	0.08696
2½ "	2.875"	8	0.12500
3 "	3.500"	8	0.12500
4 v	4.500"	8	0.12500

Unified Thread Standard

The Unified Thread Standard (UTS) defines a standard thread form and series—along with allowances, tolerances, and designations—for screw threads commonly used in the United States and Canada. It has the same 60° profile as the ISO metric screw thread used in the rest of the world, but the characteristic dimensions of each UTS thread (outer diameter and pitch) were chosen as an inch fraction rather than a round millimeter value. The UTS is currently controlled by ASME/ANSI in the United States.

Designation

The standard designation for a UTS thread is a number indicating the nominal (major) diameter of the thread, followed by the pitch measured in threads per inch. For diameters smaller than ¼ inch, an integer number defined in the standard indicates the diameter. For all other diameters, the inch figure is given.

This number pair is optionally followed by the letters UNC and UNF if the diameter-pitch combination is from the "coarse" or "fine" series, and may also be followed by a tolerance class.

Example: 6-32 UNC 2B (major diameter: 0.1380 inch, pitch: 32 tpi)

UTS PREFERRED SIZES			
Major diameter [in]	Pitch [1/in]		Major diameter [mm]
	Coarse UNC	Fine UNF	
#0 = 0.0600	-	80	1.5240
#1 = 0.0730	64	72	1.8542
#2 = 0.0860	56	64	2.1844
#3 = 0.0990	48	56	2.5146
#4 = 0.1120	40	48	2.8448
#5 = 0.1250	40	44	3.1750
#6 = 0.1380	32	40	3.5052
#8 = 0.1640	32	36	4.1656
#10 = 0.1900	24	32	4.8260
#12 = 0.2160	24	28	5.4864
1/4	20	28	6.3500
5/16	18	24	7.9375
3/8	16	24	9.5250
7/16	14	20	11.1125
1/2	13	20	12.7000
9/16	12	18	14.2875
5/8	11	18	15.8750
3/4	10	16	19.0500
7/8	9	14	22.2250
1	8	12	25.4000

Tolerance classes

A classification system exists for ease of manufacture and interchangeability of fabricated threaded items. Most (but certainly not all) threaded items are made to a classification standard called the Unified Screw Thread Standard Series. This system is analogous to the fits used with assembled parts.

Classes 1A, 2A, 3A apply to external threads; Classes 1B, 2B, 3B apply to internal threads.

Class 1 threads are loosely fitting threads intended for ease of assembly or use in a dirty environment.

Class 2 threads are the most common. They are designed to maximize strength considering typical machine shop capability and machine practice.

Class 3 threads are used for closer tolerances.

Thread class refers to the acceptable range of pitch diameter for any given thread. The pitch diameter is shown as d2 in figure 1 above. There are several methods that are used to measure the pitch diameter. The most common method used in production is by way of a Go-NoGo gauge.

References

- ASME/ANSI B1.1 – 2003 Unified Inch Screw Threads, UN & UNR Thread Form
- ASME/ANSI B1.10M – 2004 Unified Miniature Screw Threads
- ASME/ANSI B1.15 – 1995 Unified Inch Screw Threads, UNJ Thread Form

General Metric Pipe Threads

British Standard Pipe Parallel Thread

The British Standard pipe parallel (BSPP) is used primarily for threaded ports and is similar to SAE straight thread. The male has straight threads and an o-ring. The BSPP female has straight threads and a sealing face. The seal is made at the o-ring on the male and the sealing face on the female.

Thread Size	A Threads per Inch	B Thread Outside Diameter
1/4	19	.51"
3/8	19	.65"
1/2	14	.82"
3/4	14	1.03"
1	11	1.30"

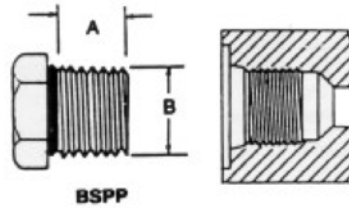

BSPP

Metric Thread

The metric thread is similar to the SAE straight thread as the seal is created by an o-ring on the male creating a seal on the smooth face or surface of the female.

Thread Size mm	A mm Between Threads	B Thread Outside Diameter
12	1.5	.47"
14	1.5	.55"
16	1.5	.63"
20	1.5	.79"
22	1.5	.88"
27	2.0	1.06"

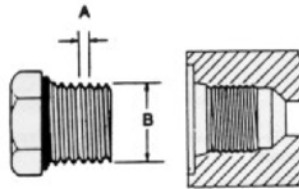

METRIC

British Standard Pipe Taper

The British Standard pipe taper (BSPT) male has tapered threads. The BSPT female has tapered threads. The seal takes place by deformation of the threads.

Thread Size	A Threads per Inch	B Thread Outside Diameter
1/4	19	.47"
3/8	19	.60"
1/2	14	.76"
3/4	14	.93"
1	11	1.23"

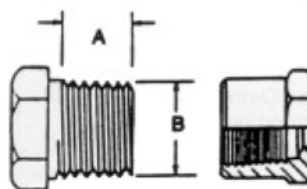

BSPT

British Standard Pipe Thread

The British Standard Pipe thread (BSP thread) is a family of standard screw thread types that has been adopted internationally for interconnecting and sealing pipe ends by mating an external (male) with an internal (female) thread.

Types

Two types of threads are distinguished:

- Parallel threads, which have a constant diameter. (G)
- Taper threads, whose diameter increases or decreases along the length of the thread. (R)

They can be combined into two types of joints:

- Jointing threads: These are pipe threads for joints made pressure-tight by the mating of the threads. They always use a taper external thread, but can have either parallel or taper internal threads. (In Continental Europe, taper internal pipe threads are not commonly used.)
- Longscrew threads: These are parallel pipe threads used where a pressure-tight joint is achieved by the compression of a soft material (gasket) on to the surface of the external thread by tightening a backnut against a socket.

Threadform

For both the taper and the parallel pipe threads, the Whitworth thread form is used, which has the following characteristics:

- symmetrical V-thread in which the angle between the flanks is 55° (measured in an axial plane)
- one-sixth of this sharp V is truncated at the top and the bottom
- the threads are rounded equally at crests and roots by circular arc tangent tangentially with the flanks
- the theoretical depth of the thread is therefore 0.64 times the nominal pitch the relation between

The major diameter listed is the outer diameter of the external thread. For a taper thread, it is the diameter at the "gauge length" from the small end of the thread. The taper is "1 to 16", meaning that for each 16 mm increase in the distance from the end, the diameter increases by 1 mm.

Pipe thread sizes

A list of 15 thread sizes is defined by the standards, ranging from 1/16 to 6. The size number was originally based on the inner diameter measured in inches (25.4 mm) of a steel tube for which the thread was intended, but is in the modern metric version of the standard simply a size number.

Pipe thread designations

These standard pipe threads are formally referred to by the following sequence of blocks:

- the words "Pipe thread",
- the document number of the standard (e.g., "ISO 7" or "EN 10226")
- the symbol for the pipe thread type:
 - G = external+internal parallel (ISO 228)
 - R = external taper (ISO 7)
 - Rp = internal parallel (ISO 7)
 - Rc = internal taper (ISO 7)
- the thread size

Threads are normally right-hand. For left-hand threads, the letters "LH" are appended.

Thread Size	Threads Per Inch	Pitch	Major Diameter of the Thread		Gauge Length	Corresponding Pipe			
			[mm]	[in]		DN	OD [mm]	OD [in]	Thickness [mm]
1/16	28	0.907	7.723	0.304	4				
1/8	28	0.907	9.728	0.383	4	6	10.2	0.40	2
1/4	19	1.337	13.157	0.518	6	8	13.5	0.53	2.3
3/8	19	1.337	16.662	0.656	6.4	10	17.2	0.68	2.3
1/2	14	1.814	20.995	0.825	8.2	15	21.3	0.84	2.6
3/4	14	1.814	26.441	1.041	9.5	20	26.9	1.06	2.6
1	11	2.309	33.249	1.309	10.4	25	33.7	1.33	3.2
1¼	11	2.309	41.910	1.650	12.7	32	42.4	1.67	3.2
1½	11	2.309	47.803	1.882	12.7	40	48.3	1.90	3.2
2	11	2.309	59.614	2.347	15.9	50	60.3	2.37	3.6
2½	11	2.309	75.184	2.960	17.5	65	76.1	3.00	3.6
3	11	2.309	87.884	3.460	20.6	80	88.9	3.50	4
4	11	2.309	113.030	4.450	25.5	100	114.3	4.50	4.5
5	11	2.309	138.430	5.450	28.6	125	139.7	5.50	5
6	11	2.309	163.830	6.450	28.6	150	165.1	6.50	5

Japanese Standards

PF - JIS Parallel Pipe Threads

PF threads are functionally interchangeable with BSPP. This is an old designations replaced with G.

Applicable Standards

- JIS B 202 PARALLEL PIPE THREADS
- ISO 228/1 PIPE THREADS PT 1: DESIGNATION, DIMENSIONS, TOLERANCE

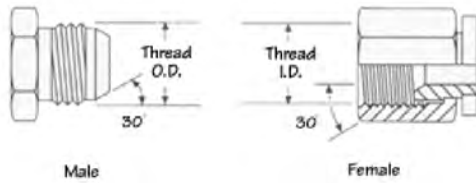

PT - JIS Taper Pipe Threads

PT threads are functionally interchangeable with BSPT threads. This is an old designations replaced with R and Rc.

Applicable Standards

- JIS B 0203 TAPER PIPE THREADS
- ISO 7/1 PIPE THREADS: DESIGNATION, DIMENSIONS/TOLERANCES

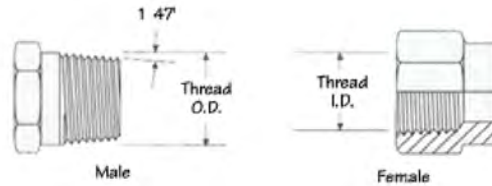

PS - JIS Parallel Internal Pipe Threads (to mate with PT threads)

Applicable Standards

- JIS B 0203 TAPER PIPE THREADS

TECHNICAL DATA

Japanese 30° Flare Parallel Threads

These Japanese 30° flare male connector will mate with a Japanese 30° flare female only.

The male and female have straight threads and a 30° seat. The seal is made on a 30° seat.

The threads on the Japanese 30° flare connector conform to JIS B 0202, which are the same as the BSPP threads. Both the British and Japanese connectors have a 30° seat, but they are not interchangeable, because the British seat is inverted.

Dash Size	Nominal Size (in.)	Thread Size	Male Thread O.D. (in.)	Female Thread I.D. (in.)
-2	1/8	1/8-28	3/8	11/32
-4	1/4	1/4-19	17/32	7/16
-6	3/8	3/8-19	21/32	19/32
-8	1/2	1/2-14	13/16	3/4
-10	5/8	5/8-14	29/32	13/16
-12	3/4	3/4-14	1 1/32	15/16
-16	1	1-11	1 5/16	1 3/16
-20	1 1/4	1 1/4-11	1 21/32	1 17/32
-24	1 1/2	1 1/2-11	1 7/8	1 25/32
-32	2	2-11	1 11/32	2 7/32

Japanese Tapered Pipe Thread

The Japanese tapered pipe thread connector is identical to and fully interchangeable with the BSPT (tapered) connector. The Japanese connector does not have a 30° Flare, and will not mate with the BSPP female.

The threads conform to JIS B 0203, which are the same as BSPT threads.

The seal on the Japanese tapered pipe thread connector is made on the threads.

Dash Size	Nominal Size (in.)	Thread Size	Male Thread O.D. (in.)	Female Thread I.D. (in.)
-2	1/8	1/8-28	3/8	11/32
-4	1/4	1/4-19	17/32	7/16
-6	3/8	3/8-19	21/32	19/32
-8	1/2	1/2-14	13/16	3/4
-12	3/4	3/4-14	1 1/32	15/16
-16	1	1-11	1 5/16	1 3/16
-20	1 1/4	1 1/4-11	1 21/32	1 17/32
-24	1 1/2	1 1/2-11	1 7/8	1 25/32
-32	2	2-11	2 11/32	2 7/32
-32	2	2-11	1 11/32	2 7/32

ISO Metric Screw Thread

The ISO metric screw threads are the worldwide most commonly used type of general-purpose screw thread. They were one of the first international standards agreed when the International Organization for Standardization was set up in 1947.

Designation

A metric ISO screw thread is designated by the letter M followed by the value of the nominal diameter D (Dmaj in the diagram above) and the pitch P, both expressed in millimeters and separated by the

multiplication sign "x".

Example: M8x1.25
If the pitch is the normally used "coarse" pitch listed in ISO 261 or ISO 262, it is omitted.

Example: M8 Tolerance classes defined in ISO 965-1 can be appended to these designations, if required.

Example: M10 – 6g in external threads.

Preferred sizes

International standard ISO 261 defines a detailed list of preferred combinations of outer diameter D and pitch P for ISO metric screw threads. ISO 262 defines the following shorter list of thread dimensions – a subset of the combinations listed in ISO 261 – which are selected sizes for screws, bolts and nuts:

Nominal Diameter (D/mm)		Pitch (P/mm)		Nominal Diameter (D/mm)		Pitch (P/mm)	
1st Choice	2nd Choice	Coarse	Fine	1st Choice	2nd Choice	Coarse	Fine
1		0.25		16		2	1.5
1.2		0.25			18	2.5	1.5
	1.4	0.3		20		2.5	1.5
1.6		0.35			22	2.5	1.5
	1.8	0.35		24		3	2
2		0.4			27	3	2
2.5		0.45		30		3.5	2
3		0.5			33	3.5	2
	3.5	0.6		36		4	3
4		0.7			39	4	3
5		0.8		42		4.5	3
6		1			45	4.5	3
	7	1		48		5	3
8		1.25	1		52	5	4
10		1.5	1.25	56		5.5	4
12		1.75	1.5		60	5.5	4
	14	2	1.5	64		6	4

The "coarse" pitch is the commonly used default pitch for a given diameter. In addition, one or two smaller "fine" pitches are defined, for use in applications where the height of the normal "coarse" pitch would be unsuitable (e.g., threads in thin-walled pipes). The terms "coarse" and "fine" have in this context no relation to the manufacturing quality of the thread.

References

International standards:

- ISO 68-1: ISO general-purpose screw threads – Basic profile – Metric screw threads.
- ISO 261: ISO general-purpose metric screw threads – General plan.
- ISO 262: ISO general-purpose metric screw threads – Selected sizes for screws, bolts and nuts.
- ISO 965-1: ISO general-purpose metric screw threads – Tolerances – Part 1: Principles and basic data.

Equivalent national standards:

- BS 3643: ISO metric screw threads
- ANSI/ASME B1.13M: Metric Screw Threads: M Profile

"Hybrid" Torque Specifications - Sprint/BSP and Pro-Fit®/NPTF

"Hybrid" Torque Specifications - (Sprint - BSP Fittings assembled into female NPTF ports)

Caution: Mating material and female ports may be too soft for high torque values.

Check material hardness to avoid stripping, galling or cross-threading.

This table is ONLY a guide for "hybrid" situations that require interchanging thread types to accommodate tubing requirements.

Thread Size	Minimum Torque Value		Maximum Torque Value	
	Nm	Ft-Lbs	Nm	Ft-Lbs
Sprint				
1/8" *	1.0	0.7	10.0	7.4
1/4" *	4.0	2.9	20.0	14.8
3/8"	27.0	20.0	54.0	40.0
1/2"	27.0	20.0	67.0	50.0

Hybrid Use:

- When metric tube fittings require assembly in alternate NPTF ports.
- Thread sizes 1/8" and 1/4" interchange without concern for torque with Camozzi's patented Sprint and Compact sealing system.
- For 3/8" and 1/2" threads, use caution, and consult hybrid torque specifications below.

* Hybrid torque values for these thread sizes are equal to the torque values for conventional use (BSP male to BSP female).

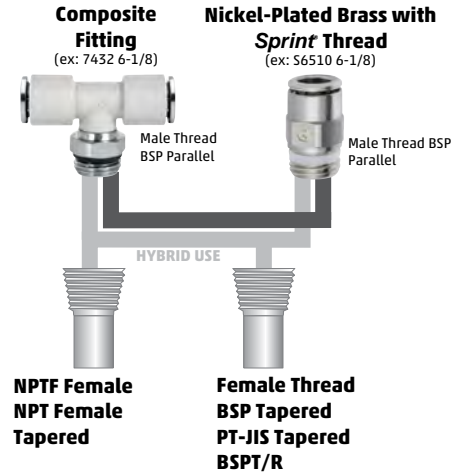

"Hybrid" Torque Specifications - (Pro-Fit® - NPTF Fittings assembled into female BSP ports)

Caution: Mating material and female ports may be too soft for high torque values.

Check material hardness to avoid stripping, galling or cross-threading.

This table is ONLY a guide for "hybrid" situations that require interchanging thread types to accommodate tubing requirements.

Thread Size	Minimum Torque Value		Maximum Torque Value	
	Nm	Ft-Lbs	Nm	Ft-Lbs
Pro-Fit®				
1/8" *	1.0	0.7	10.0	7.4
1/4" *	4.0	2.9	20.0	14.8
3/8" *	5.0	3.7	20.0	14.8
1/2"	27.0	20.0	54.0	40.0

Hybrid Use:

- When inch OD tube fittings require assembly in alternate BSP ports.
- Thread sizes 1/8", 1/4", and 3/8" interchange without concern for torque with Camozzi's patented Pro-Fit® Thread sealing system.
- For 1/2" threads, use caution, and consult hybrid torque specifications below.

* Hybrid torque values for these thread sizes are equal to the torque values for conventional use (NPTF male to NPTF female).

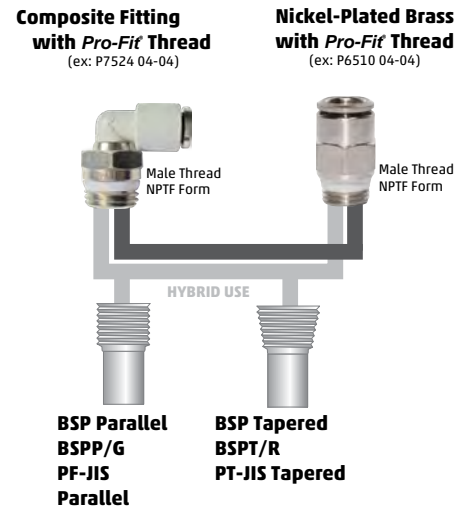

O-Ring Replacement for Camozzi Push-In Fittings

8

TECHNICAL DATA



1. Grip fitting evenly on non-thread, or non-sealing surfaces, (avoid gripping places such as stem OD).

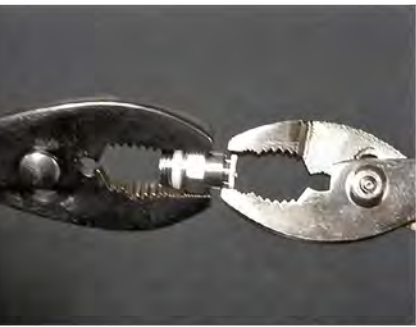

2. Grip collet evenly with pliers.



3. With an even and straight pulling motion, pull collet out of body parallel. ** Do not use a screwdriver or making any prying motions at an angle in removing the collet.



4. With a blunt pick or hook, pull (fish), out the oring from the oring gland seat.
** Take care to not scratch the inner surface of the body.



5. Check the inner surface/gland where the oring had been. Look for any debris. If any debris or dirt, clean out before inserting new oring. ** If any excessive scratches appear on the inner gland surface, (more than typical machining marks), the fitting should be discarded.

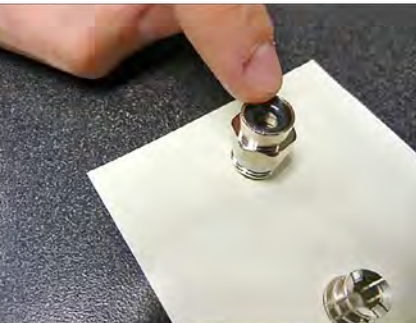

6. Place new oring on the open body throat. Insert the oring partially down the body throat. Use even pressure from your finger to insert the oring in a flat position. ** Take care that the oring is not twisted, or slips vertically and falls down the body cavity.



7. Check that collet shape is still uniform, cylindrical and that none of the collet teeth or legs is bent inward or outward. Place the collet evenly and squarely on the oring, (still sitting flatly inside the throat of the body). The collet should sit on the newly inserted oring and appear as if the collet and its legs can insert inside the fitting body without interfering with side walls of the fitting body.

Begin applying uniform force to insert the collet and oring completely down the body throat cavity. If the collet legs/teeth compress inward slightly, this is O.K. and perfectly normal.

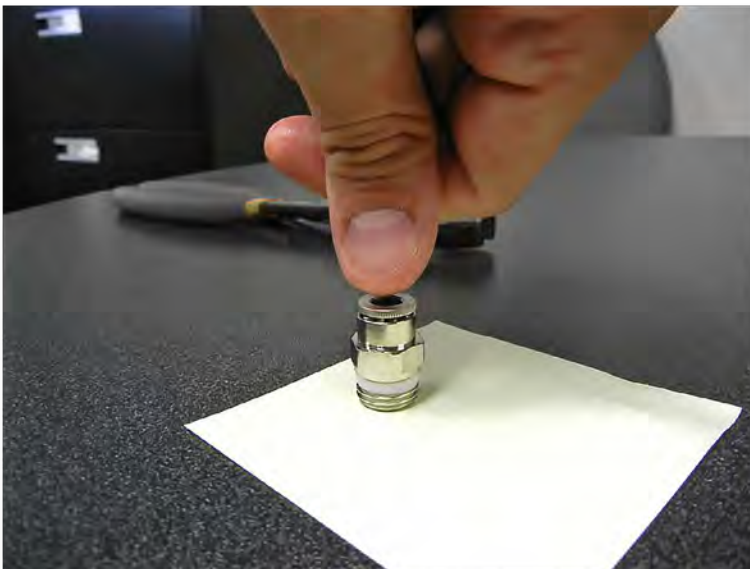

8. During insertion of the collet and new oring, the collet will feel as if it snaps downward into place. Check that the collet swivels freely and check down the throat of the fitting body to make certain that the oring is sitting squarely in its original gland. ** There should be nothing seen down the gland/throat that would interfere with the normal tubing insertion or flow path. Oring and Collet re-assembly is complete.

Marketing Materials

9

MARKETING MATERIALS



Camozzi Overview Brochure
93-1500-0GB024



North American Cylinder & Actuator Catalog Ed. 8.6
93-0517-USA001



North American Fittings & Flow Control Valves Catalog Ed 8.6
93-0515-USA001



North American Valve Catalog Ed 8.5
93-0513-USA002



North American FRL Catalog 8.5
93-0513-USA001



Metric Master Catalog 8.8
93-0517-0GB001



Short Form Metric Master Catalog 8.8
93-1009-0GB023



C_Electrics Catalog
93-1005-0GB079

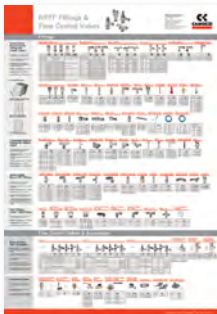

Wall Chart Fittings Poster USA NPTF
93-5000-USA003



BSP Fittings Poster
93-5000-0GB005



Cylinder & Actuator Poster
93-5000-0GB008



Fitting Selector Guide
93-1500-USA002



Metric Fittings Bin Labels
SUS93-5500-0012



Pro-Fit® Fittings Brochure
93-1002-0GB004



NPTF Fittings Bin Labels
SUS93-5500-0013



Distributor Full Line
Sample Case
94-1160-0006



Assorted Fittings
Sample Case
94-1160-0009



DOT Fittings Sample Case
94-1160-0010



Composite Fittings Sample Case
Fittings Sample Case
94-1160-0016



Modular Fittings Cabinet Deluxe
94-1500-0004

Customized Fittings and Flow Control Valve Production

Various Industries Served: (not limited to...)

1. Automotive

- a. Cartridges with extra long shafts and c-clip retention,
- b. Schrader valve integrated into fitting
- c. Bulkhead panel-mount with integrated female threads for tire mounting equipment

2. Water & Misting

- a. Hose-Bib adapters for garden hose applications
- b. Push-In misting adapters for bug-misting nozzles
- c. Misting unions with VITON o-rings for water-misting nozzles

3. Fluid Dispensing

- a. Fittings w/ Integrated Check-Valves
- b. Fittings w/ Integrated Shut-Off Valves
- c. Flow-Control Valves with barb connections and VITON o-rings

4. Paintball Recreation

- a. Straight Fittings with swivels
- b. Elbow fittings with integrated wire-mesh filters

5. Dental/Water

- a. Customized High-Phosphorous Chemical Nickel-Plating for "stainless-like" corrosion resistance and wear properties
- b. EPDM o-ring fittings for better chemical resistance

6. Wood Working



9

MARKETING MATERIALS

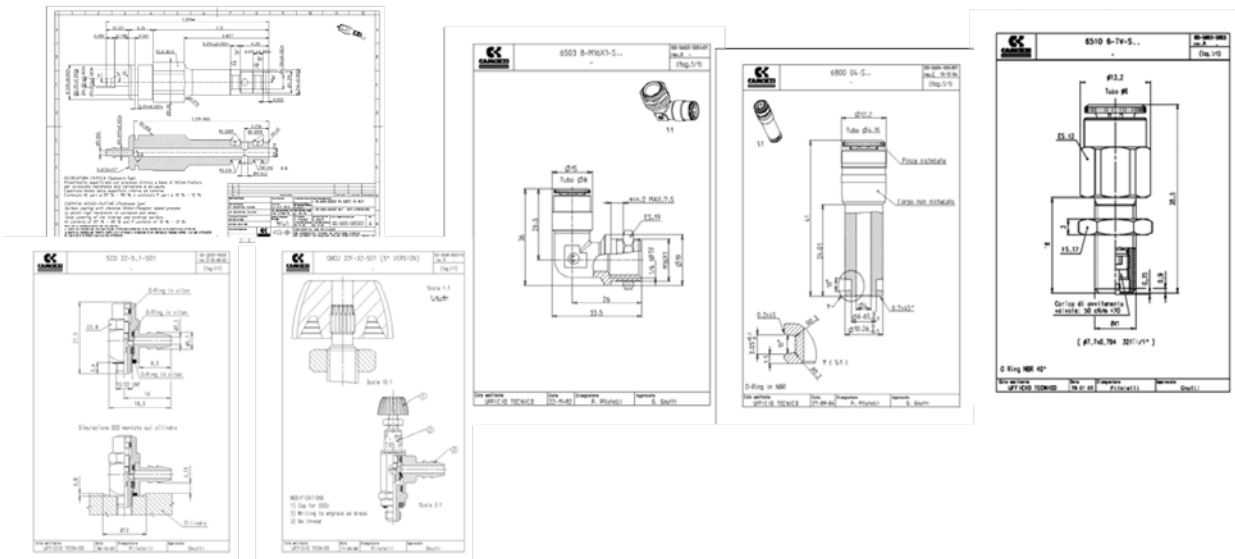

*Camozzi
in the world*

Camozzi spa
Società Unipersonale
Via Eritrea, 20/I
25126 Brescia
Italy
Tel. +39 030/37921
Fax +39 030/2400430
sales@camozzi.com
www.camozzi.com

Camozzi Neumatica S.A.
Prof. Dr. Pedro Chutro 3048
1437 Buenos Aires
Argentina
Tel. +54 11/49110816
Fax +54 11/49124191
info@camozzi.com.ar
www.camozzi.com.ar

Camozzi GmbH Pneumatic
Löfflerweg 18
A-6060 Hall in Tirol
Austria
Tel. +43 5223/52888-0
Fax +43 5223/52888-500
info@camozzi.at
www.camozzi.at

Camozzi do Brasil Ltda.
Rua Estácio de Sá, 1042
13080-010 Campinas SP
Brazil
Tel. +55 19/21374500
Fax +55 19/21374530
sac@camozzi.com.br
www.camozzi.com.br

Camozzi Pneumatic
66-1, Perehodnaya str.,
220070, Minsk
Belarus
Tel. +375 17/3961170 (71)
Fax +375 17/3961170 (71)
info@camozzi.by
www.camozzi.by

**Shanghai Camozzi Pneumatic
Control Components Co, Ltd.**
717 Shuang Dan Road, Malu
Shanghai - 201801
China
Tel. +86 21/59100999
Fax +86 21/59100333
info@camozzi.com.cn
www.camozzi.com.cn

**Shanghai Camozzi Automation
Control Co, Ltd.**
717 Shuang Dan Road, Malu
Shanghai - 201801
China
Tel. +86 21/59100999
Fax +86 21/59100333
info@camozzi.com.cn
www.camozzi.com.cn

Camozzi S.r.o.
V Chotejně 700/7
Praha - 102 00
Czech Republic
Tel. +420 272/690 994
Fax +420 272/700 485
info@camozzi.cz
www.camozzi.cz

Camozzi ApS
Metalvej 7 F
4000 Roskilde
Denmark
Tel. +45 46/750202
info@camozzi.dk
www.camozzi.dk

Camozzi Automation OÜ
Osmussaare 8-B204
13811 Tallinn
Estonia
Tel. +372 6119055
Fax +372 6119055
info@camozzi.ee
www.camozzi.ee

Camozzi Pneumatique Sarl
5, Rue Louis Gattefossé
Parc de la Bandonnière
69800 Saint-Priest
France
Tel. +33 (0)478/213408
Fax +33 (0)472/280136
info@camozzi.fr
www.camozzi.fr

Camozzi GmbH Pneumatic
Porschestraße 1
D-73095 Albershausen
Germany
Tel. +49 7161/91010-0
Fax +49 7161/91010-99
info@camozzi.de
www.camozzi.de

Camozzi India Private Limited
No D-44 Phase II Ext.,
Hosiery Complex
Noida - 201 305
Uttar Pradesh
India
Tel. +91 120/4055252
Fax +91 120/4055200
info@camozzi-india.com
www.camozzi.in

**Camozzi Pneumatic
Kazakhstan LLP**
Shevchenko/Radostovets,
165b/72g, off. 615
050009 Almaty
Kazakhstan
Tel. +7 727/3335334 - 3236250
Fax +7 727/2377716 (17)
info@camozzi.kz
www.camozzi.kz

Camozzi Malaysia SDN. BHD.
30 & 32, Jalan Industri USJ 1/3
Taman Perindustrian USJ 1
47600 Subang Jaya
Selangor
Malaysia
Tel. +60 3/80238400
Fax +60 3/80235626
cammal@camozzi.com.my
www.camozzi.com.my

**Camozzi Neumatica de Mexico
S.A. de C.V.**
Lago Tanganica 707
Col. Ocho Cedros 2ª sección
50170 Toluca
México
Tel. +52 722/2707880 - 2126283
Fax +52 722/2707860
camozzi@camozzi.com.mx
www.camozzi.com.mx

Camozzi AS
Verstedveien 8
1400 Ski
Norway
Tel. +47 40644920
info@camozzi.no
www.camozzi.no

Camozzi Pneumatic LLC
Leningrad highway, 69, 1
RIVER CITY office 23, 2nd Floor
125445, Moscow
Russian Federation
Tel. +7 495/6650255
Fax +7 495/6650255
info@camozzi.ru
www.camozzi.ru

Camozzi Pneumatik AB
Box 9214
Bronsyegatan 7
20039 Malmö
Sweden
Tel. +46 40/6005800
info@camozzi.se
www.camozzi.se

Camozzi Benelux B.V.
De Vijf Boeken 1 A
2911 BL Nieuwerkerk a/d IJssel
The Netherlands
Tel. +31 180/316677
Fax +31 180/316616
info@camozzi.nl
www.camozzi.nl

LLC Camozzi
Kirillovskaya Str, 1-3, section "D"
Kiev - 04080
Ukraine
Tel. +38 044/5369520
Fax +38 044/5369520
info@camozzi.ua
www.camozzi.ua

Camozzi Pneumatics Ltd.
The Fluid Power Centre
Watling Street
Nuneaton, Warwickshire
CV11 6BQ
United Kingdom
Tel. +44 (0)24/76374114
Fax +44 (0)24/76347520
info@camozzi.co.uk
www.camozzi.co.uk

Camozzi Pneumatics Inc.
Street address:
2160 Redbud Boulevard, Suite 101
McKinney, TX 75069-8252
Remittances:
P.O. Box 678518
Dallas, TX 75267-8518
USA
Tel. +1 972/5488885
Fax +1 972/5482110
info@camozzi-usa.com
www.camozzi-usa.com

Camozzi Venezuela S.A.
Calle 146 con Av. 62
N°146-180
P.O. Box 529
Zona Industrial Maracaibo
Edo. Zulia
Venezuela
Tel. +58 261/7360821
Fax +58 261/7360401
info@camozzi.com.ve
www.camozzi.com.ve

**Camozzi R.O.
in Hochiminh City**
6th Floor, Master Building,
155 Hai Ba Trung St.,
Ward 6, District 3
Hochiminh City
Vietnam
Tel. +84 8/54477588
Fax +84 8/54477877
bthien@camozzi.com.vn
www.camozzi.com.vn

*Camozzi
distributors
in the world*

Europe

ZULEX d.o.o.

Safeta Zajke 115b
Sarajevo
Bosnia-Herzegovina
Tel. +387 33/776580
Fax +387 33/776583
zulex@bih.net.ba
www.zulex.com.ba

L.D. GmbH

Zar Samuil Str. 116
1202 Sofia
Bulgary
Tel. +359 2/9269011
Fax +359 2/9269025
camozzi@ld-gmbh.com
www.ld-gmbh.com

Bibus Zagreb d.o.o.

Anina 91
HR 10000 Zagreb
Croatia
Tel. +385 1/3818004 - 3818006
Fax +385 1/3818005
bibus@bibus.hr
www.bibus.hr

TS Hydropower Ltd.

Industrial Area N°64
Aglanzia 21-03
Nicosia
Cyprus
Tel. +357 22/332085
Fax +357 22/338608
tshydro@cytanet.com.cy

AVS-Yhtiöt Oy

Rusthollarinkatu 8
02270 Espoo
Finland
Tel. +358 10/6137100
Fax +358 10/6137701
info@avs-yhtiot.fi
www.avs-yhtiot.fi

Technomatic control s.a.

Esopou Street
Kalohori
570 09 Thessaloniki
Greece
Tel. +30 2310/778730
Fax +30 2310/778732
info@technomatic.gr
www.technomatic.gr

Tech-Con Hungária Kft

Véső u. 9-11 (entrance: Süllő u. 8.)
1133 Budapest
Hungary
Tel. +36 1/412 4161
Fax +36 1/412 4171
tech-con@tech-con.hu
www.tech-con.hu

Loft & Raftæk

Hjallabrekka 1
200 Kópavogur
Iceland
Tel. +354 564/3000
Fax +354 564/0030
gummi@loft.is
www.loft.is

DBF TECHNIC SIA

Bauskas iela 20 - 302
1004 Riga
Latvia
Tel. +371 296 26916
Fax +371 6 7808650
info@pneumatika.lv
www.pneumatika.lv

Hidroteka Engineering Services

Chemijos 29E
LT-51333 Kaunas
Lithuania
Tel. +370 37/452969
Fax +370 37/760500
hidroteka@hidroteka.lt
www.hidroteka.lt

Rayair Automation Ltd.

KW23G - Corradino Ind. Estate
Paola, PLA3000
Paola, Pla 08
Malta
Tel. +356 21/672497
Fax +356 21/805181
sales@rayair-automation.com
www.rayair-automation.com

Bibus Menos Sp. z o.o.

ul. Spadochroniarzy 18
80-298 Gdańsk
Poland
Tel. +48 58/6609570
Fax +48 58/6617132
info@bibusmenos.pl
www.bibusmenos.pl

Teclena - Automatizacão, Estudos e Representações, S.A.

Rua Dos Camponeses, n° 390
Zona Industrial do Vale Sepal
2400-316 Leiria
Portugal
Tel. +351 244/860980
Fax +351 244/812832
geral@teclena.pt
www.teclena.pt

Experts d.o.o.

Mitropolit Teodosij Gologanov, 149
MK-1000 Skopje
Rep. of Macedonia
Tel. +389 2/3081970
Fax +389 2/3084871
experts@t-home.mk
www.experts.com.mk

Tech-Con Industry Srl

Calea Crângasi N°60
Sector 6 , 060346 Bucharest
Romania
Tel. +40 21/2219640
Fax +40 21/2219766
paul.stoica@tech-congroup.com
www.tech-con.ro

Tech-Con d.o.o. Beograd

Cara Dušana 205a
11080 Zemun - Belgrade
Serbia
Tel. +381 11/4142790
Fax +381 11/3166760
office@tech-con.rs
www.tech-con.rs

STAF Automation s.r.o.

Kostiviarska 4944/5
974 01 Banská Bystrica
Slovakia
Tel. +421 48/4722777
Fax +421 48/4722755
staf@staf.sk
www.staf.sk

Kovimex d.o.o.

Podskrajnik 60,
SI-1380 Cerknica
Slovenia
Tel. +386 1/7096430
Fax +386 1/7051930
kovimex@kovimex.si

Esperia S.A.

Arangutxi, 13
Poligono Industrial De Jundiz
01015 Vitoria
Spain
Tel. +34 945/290105
Fax +34 945/290356
comercial@esperia.es
www.esperia.es

Bibus AG

Allmendstrasse 26
CH-8320 Fehraltorf
Switzerland
Tel. +41 44/8775011
Fax +41 44/8775019
info.bag@bibus.ch
www.bibus.ch

Hidrel Hidrolik Elemanlar

Sanayi Ve Ticaret A.S.
Perçemli Sokak, No 11 Tünel Mevkii
80000 Karakoy - Istanbul
Turkey
Tel. +90 212/2517318 - 2494881
Fax +90 212/2920850
hidrel@superonline.com

>>



*Camozzi
distributors
in the world*

America

Marco Industrial spa
Los Gobellinos # 2584 - Renca
Santiago
Chile
Tel. +56 22782 4400
Fax +56 22646 4623
marcoindustrial@marco.cl
www.marcoindustrial.cl

Euroindustrial Ltda
Carrera 25A # 4B-64
Bogotá

Colombia
Tel. +57 1/5606140
Fax +57 1/5609576
www.euro-industrial.net

Eurotécnica de Costa Rica AYM, S.A.
150 m oeste del cruce de Llorente,
hacia Epa Tibás

Costa Rica
Tel. +506 2241/4242 - 4230
Fax +506 2241/4272
eurotecnica@eurotecnicacr.com
www.eurotecnicacr.com

LT Industrial, EIRL
Ave. Charles Summer #53, suite 24B
Plaza Charles Summer
Santo Domingo
Dominican Republic
Tel. +1809-623-5156
Fax +1829-956-7205
info@ltindustrialrd.com

Fluidica Cia. Ltda.
Abelardo Moncayo Oe4-08 y Av. América
Quito, Pichincha
Ecuador
Tel. +593 2/2440848 - 2/5102004
Fax +593 2/2440848
info@fluidica-ec.com
www.fluidica-ec.com

Aplitec S.A. de C.V.
75 Av. Nte,
Residencial Escalón Norte II
Pje KL #3-C
San Salvador
El Salvador
Tel. +503 2557/2666
Fax +503 2557/2652
info@aplitecsv.com
www.aplitescsv.com

Isotex de Panamá S.A.
Plaza Conquistador Local #5
Panama City
Panamá
Tel. +507 217/0050 - 217/0106
Fax +507 217/0049
gerencia@isotexpanama.com
info@isotexpanama.com

Eicepak S.A.C.
Av. Los Cipreses N° 484 Los Ficus
Santa Anita - Lima
Perú
Tel. +51 1/3628484 - 3627127
- 3628698
Fax +51 1/3625602
eicepak@eicepak.com
www.eicepak.com

Cocles S.A.
BVAR Artigas 4543 P.O. Box 11800
Montevideo
Uruguay
Tel. +598 2/2006428 - 2090446
Fax +598 2/206428
cocles@adinet.com.uy
www.cocles.com.uy

Middle East

Compressed Air Technology Co.Saa
83 - El Sabteya Str.
21211 Sabteya ET
Kairo
Egypt
Tel. +20 2/25766266 - 25774400
Fax +20 2/25750113
neveen@elhaggarmisr.com

E. Yeruham & Comp. Ltd.
34 Hahofer Street
P.O. Box 11884 Holon
58117 Holon
Israel
Tel. +972 3/5567322
Fax +972 3/5596616
office@ayeruham.com
www.ayeruham.com

**Raymond Feghali Co.
For Trade & Industry SARL**
Naher El-Mott Highway, Zalka
P.O. BOX 90-723 Jdeideh
Lebanon
Tel. +961 1/893176 - 894545
Fax +961 1/879500
RTF@raymondfehalico.com
www.raymondfehalico.com

Techno-Line Trading & Services WLL
Ware House 05, Building 2189
Road 1529, Block 115
Hidd
Kingdom of Bahrain
Tel. +973 17783906
Fax +973 17786906
techline@batelco.com.bh

**AL-Maram National Co. For Buildings
General Contracting W.L.L.**
Shuwaikh Industrial Area Pl. Shop No. 9
Shuwaikh
Kuwait
Tel./Fax +965 24828108
almaramkuwait@gmail.com
www.almaramgtc.com

Al-Hawaiya for Industrial Solutions Estab-
lishment. (ALHA)
Kilo - 3, Makkah Road
P.O. Box 11429
Jeddah 21453
Saudi Arabia
Tel. +966 2/6885524
Fax +966 2/6885061
info@alha.com.sa
www.alha.com.sa

**I.M.O.
Industrial Machine Trd. Co. L.L.C.**
P.O. Box 20376
Sharjah
United Arab Emirates
Tel. +971 6/5437991
Fax +971 6/5437994
imo@eim.ae

Asia

PT. Golden Archy Sakti
Kompleks Prima Centre Blok B2 No.2
Jl.Pool PPD - Pesing Poglar No.11,
Kedaung Kali Angke - Cengkareng,
Jakarta Barat 11710
Indonesia
Tel. +62 21/54377888
Fax +62 21/54377089
sales@archy.co.id
www.archy.co.id

Seika Corporation
Aqua Dojima East Bldg.
16F, 4-4, 1-Chome, Dojimahama,
Kita-Ku Osaka
Japan
Tel. +81 6/63453176
Fax +81 6/63443584
kuronakat@jp.seika.com

Polytechnic Automation
Suite 604, 6th Floor, K. S.
Trade Tower,
New Challi,
Shahrah-e-Liaquat,
Karachi - 74000,
Pakistan
Tel. +9221 32426612
Fax +9221 32426188
polytech_ent@yahoo.com

Exceltec Automation Inc.
608-G, EL-AL Building,
Quezon Avenue, Tatalon
Quezon City, 1113
Philippines
Tel. +632/4161143 - 4161141
- 7319015
Fax +632/7121672
sales.manila@extec.com

Exceltec Enviro Pte Ltd
Block 3025 Ubi Road 3
03-141
408653
Singapore
Tel. +65 67436083
Fax +65 67439286
sales@extec.com

Tae-Seung
537, Dansan-ro,
Dong-gu, Daegu
South Korea
Tel. +82 53/356 7212
Fax +82 53/356 7213
tss369@hanmail.net
www.khic.co.kr

**Savikma Automation & Engineering
Services (Pvt) Ltd.**
22, Wattedegara Road
Maharagama
Sri Lanka
Tel. +94 115642164
Hot line +94 777800070
Fax +94 112844777
saes@slt.net.lk

**Zenith Automation
International Co., Ltd.**
7F., No.22, Ln. 200, Sec. 2,
Dunhua S. Rd.
Da'an Dist.,
Taipei City 10669
Taiwan
Tel. +886 2/2378 1267
Fax +886 2/3322 8973
zaisales@z-auto.com.tw
www.z-auto.com.tw

Pneumax Co. Ltd.
107/1 Chaloe Phrakiat R.9 Rd.,
Pravet - Bangkok 10250
Thailand
Tel. +66 2/7268000
Fax +66 2/7268260
import@pneumax.co.th
www.pneumax.co.th

*Camozzi
distributors
in the world*

Africa

Boudissa Technology Sarl
25, Cité 20 Août 1955
Oued Roumane El Achour
Algiers - 16403

Algeria

Tel./Fax +213 (0) 23316751
Tel./Fax +213 (0) 23316733
contact@boudissatech.com
www.boudissatech.com

DISMATEC

Distribution de Matériels Techniques
N° RCCM-CI-ABJ-2010B1882
16 BP 236 ABIDJAN 16

Ivory Coast

Tel. +225 21267091
Fax +225 21262367
dismatec2002@yahoo.fr

FHP s.a. Flexibles Haute Pression

25 Rue Lt Puissesseau
Casablanca

Morocco

Tel. +212 22/301997
Fax +212 22/301913
fhpelidrissi@iam.net.ma

Hydramatics Control Equipment

15 Village Crescent,
Linbro Business Park,
Sandton Johannesburg 2065

South Africa

Tel. +2711/6081340 - 1 - 2
Fax +2786/5516311
mjones@hydramatics.co.za
www.hydramatics.co.za

A.T.C. Automatisme

Avenue Habib Bourguiba
Centra Said - BP 25 2033
Megrine

Tunisia

Tel. +216 71/297328
Fax +216 71/429084
commercial@atc.com.tn
www.atc.automatisme.com

Oceania

Griffiths Components Pty Ltd

605 Burwood Hwy
Knoxfield Victoria
Melbourne 3180

Australia

Tel. +61 3/9800 6500
Fax +61 3/9801 8553
enquiry@camozzi.com.au