

MOD BLOCK - 2X2 Performance

IP67-Rated Module built with Cree XHP70.2 LEDs

Primary Applications



High Mast
Streetlight
Stadium
Architectural
Canopy
Garage
Portable
High bay

Features and Benefits

- IP67 Protection – Self-contained module for outdoor applications or other difficult environments
- Optical Flexibility – a variety of off-the-shelf optical patterns are available; built with LEDiL optics.
- Integrate Further – Easy to add multiple modules through our interlocking technology
- Easy Mounting – designed for quick mounting to a housing or bracket
- Performance – industry leading lumen density and lumens per pound
- Certifications – RoHS compliant
- Custom - private label or design changes available



Introducing the NewEnergy IP67 rated LED heat sink module using Cree XHP70.2 Extreme High Power LEDs. This NewEnergy module is engineered to bring high quality lighting systems to market faster with fewer LEDs, higher reliability, and a lower system cost. This module is a robust, flexible, and versatile building block for any number of lighting systems such as high bay, low bay, parking, and stadium lighting.

Interlocking Technology to Add More Modules

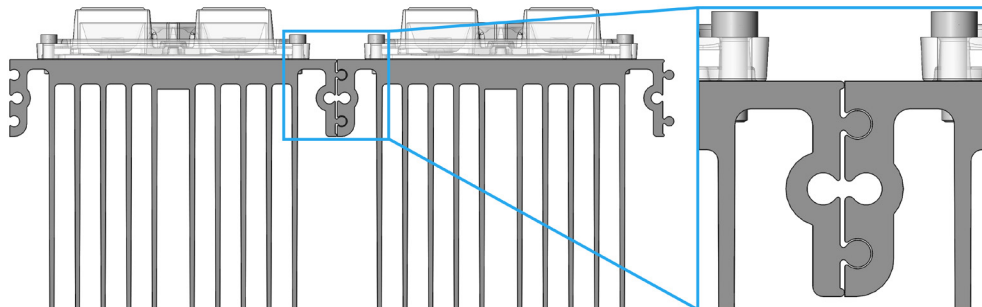

Last Modified: 06/22/2023

MOD BLOCK - 2X2 Performance Specifications

Order Code Formatting

Series	-	Color Temperature	Color Rendering Index	-	Optic	-	Cable Type	-	Internal Code
MP22T1 -C24 - XHP70.2 Mod Block		27 - 2700K	70 - 70 CRI		M		1 - Cable Pigtail		XX
		30 - 3000K	80 - 80 CRI		WW		2 - Waterproof M15 Cable		
		40 - 4000K	90 - 90 CRI		WWW				
		50 - 5000K			T2				
		57 - 5700K			T3				
					T4				
					T5				

*See Page 5
for Photometric
Distributions

MOD BLOCK - 2X2 Performance Specifications

Ordering Information

Part Number	CCT	CRI	Binning	Forward Voltage (V)	Current (mA)	Typical Luminous Flux (lm)	Efficacy Nominal (lm/W)	Watts (W)
MP22T1 -C24-5770-x	5700K	70	ANSI	44.6	700	5050	162	31
	5700K	70	ANSI	45.8	1500	9250	134	69
	5700K	70	ANSI	46.3	2100	11250	116	97
MP22T1 -C24-5070-x	5000K	70	5-Step	44.6	700	5050	162	31
	5000K	70	5-Step	45.8	1500	9250	134	69
	5000K	70	5-Step	46.3	2100	11250	116	97
MP22T1 -C24-4070-x	4000K	70	5-Step	44.6	700	5050	162	31
	4000K	70	5-Step	45.8	1500	9250	134	69
	4000K	70	5-Step	46.3	2100	11250	116	97

Product performance based on 25°C ambient temperature.
All values shown above are typical.

Ratings

Parameter	Unit	Rating
Operating Temperature	°C	-40 to +50
Weight	G	865

Performance Groups – Chromaticity

Binning	CCT	X	Y
ANSI	5700K	0.3207	0.3462
		0.3376	0.3616
		0.3366	0.3369
		0.3222	0.3243

Binning	CCT	Center Point		Major Axis		Rotation Angle (°)
		X	Y	a	b	
5-Step	5000K	0.3447	0.3553	0.01400	0.00520	65.0
5-Step	4000K	0.3818	0.3797	0.001420	0.00550	61.5

MOD BLOCK - 2X2 Performance Specifications

Performance Characteristics

Lumens vs Drive Current

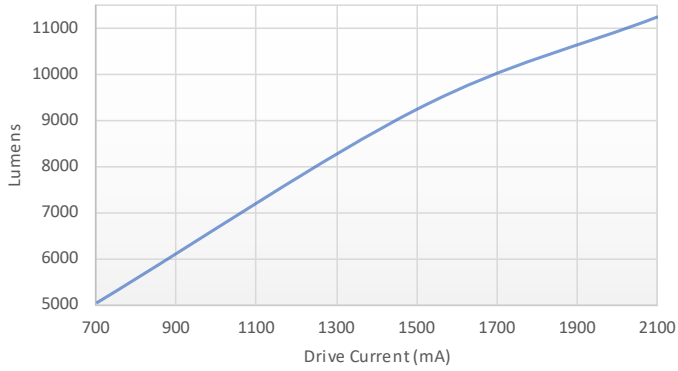

Tsp vs Drive Current

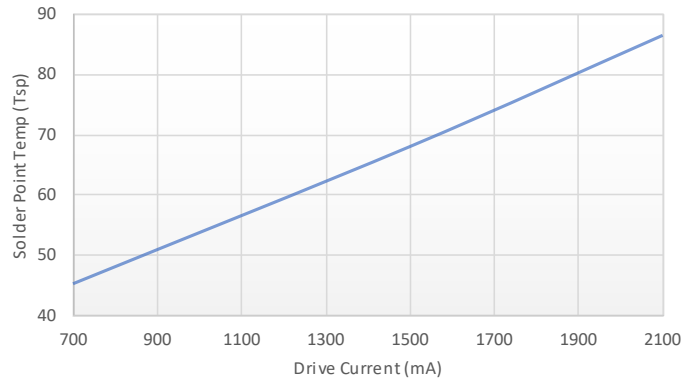

Efficacy vs Drive Current

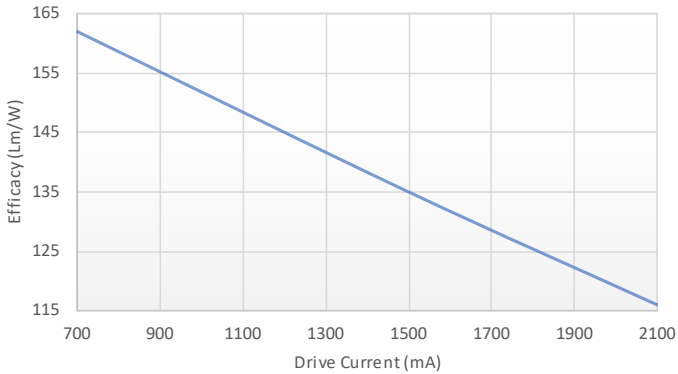

Tsp vs Lumens

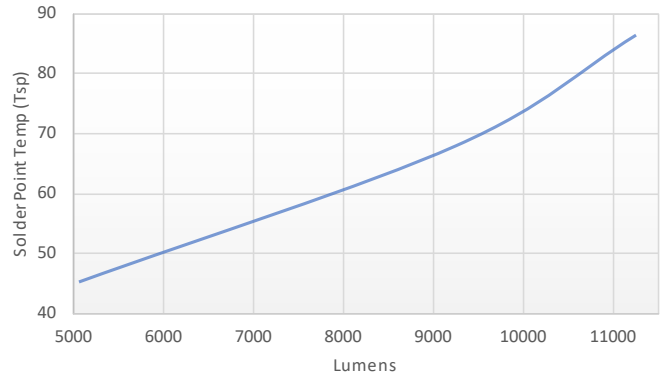

Power vs Drive Current

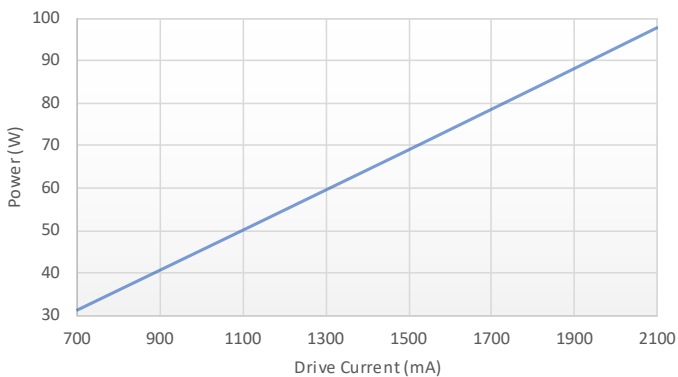

*Product performance based on 25°C ambient temperature

MOD BLOCK - 2X2 Performance Specifications

Photometric Distributions

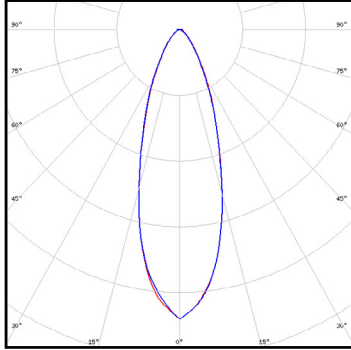

M - Medium
High Bay Series

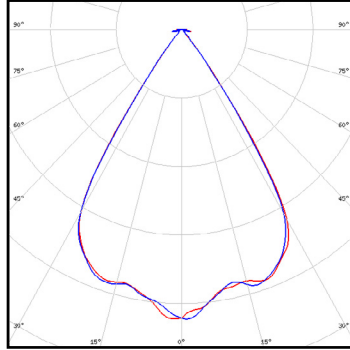

WW - Wide
High Bay Series

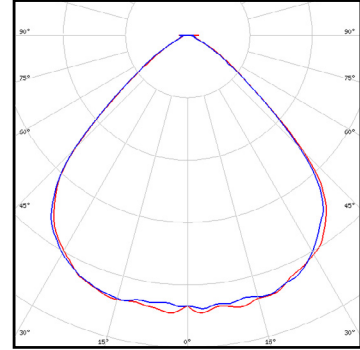

WWW - Very Wide
High Bay Series

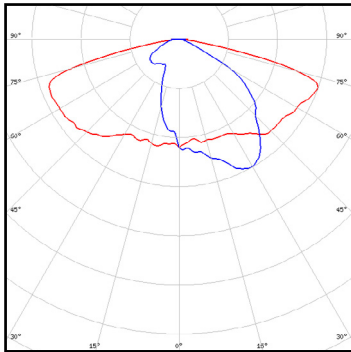

T2 - IESNA Type II
Roadway Series

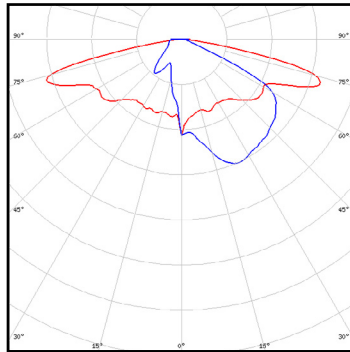

T3 - IESNA Type III
Roadway Series

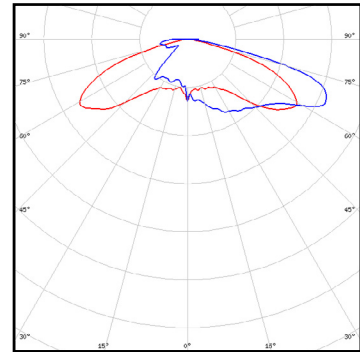

T4 - IESNA Type IV
Roadway Series

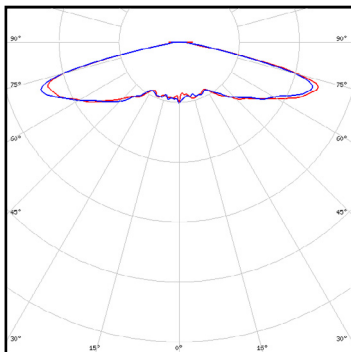

T5 - IESNA Type V Square
Roadway Series

*Photometric distributions made with LEDiL optics

MOD BLOCK - 2X2 Performance Specifications

Mechanical Dimensions

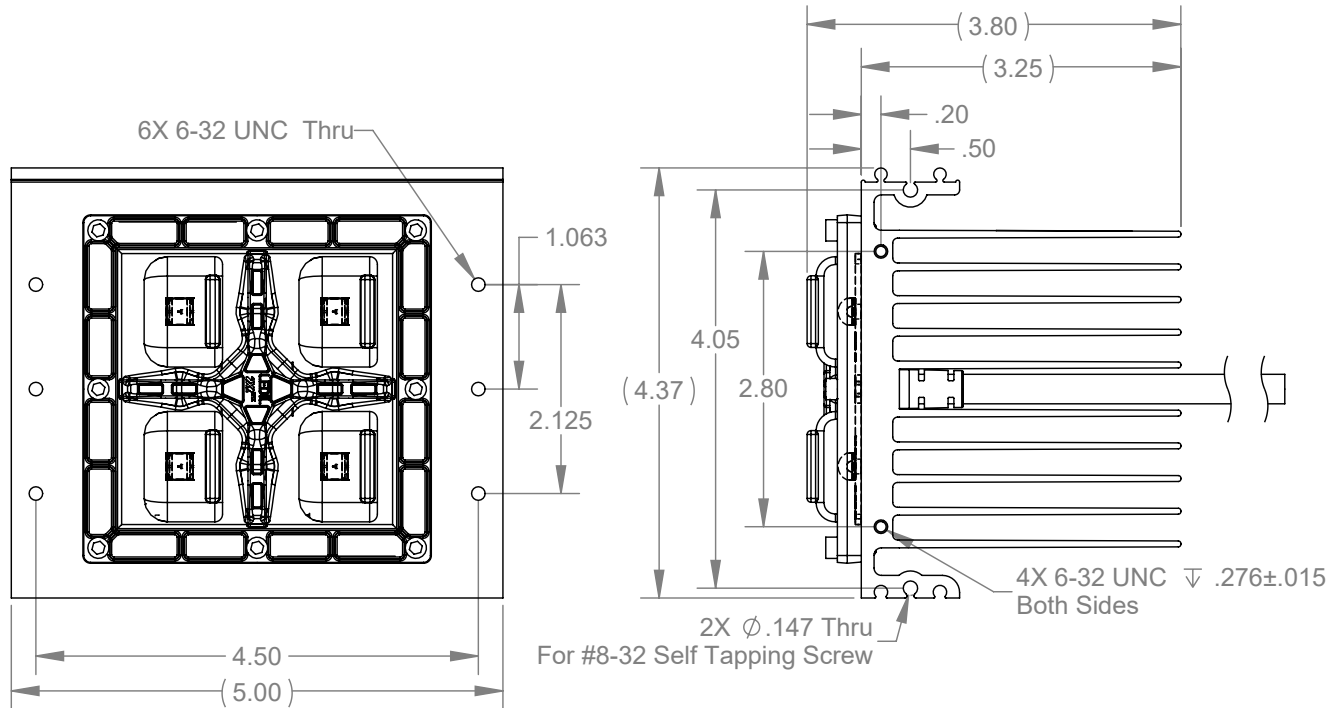

Cable Specs:

Cable Length: 20"

Cable OD: .288"

Wire Gauge: 18AWG

Wire Colors: White (+), Black (-)

Wire Voltage Rating: 300V

Wire Temperature Rating: 105°C