

NRF Series Circuit Protectors

Snaps into a 16-mm-diameter hole

Wide variety of applications such as office automation equipment

- 16-mm-dia fuse holder size
- More than 1,000 repeat operations
- Snap-on mounting
- Visible trip indicator
- Variety of rated currents
- Available with auxiliary contact which can be used to make an alarm or control circuit
- Solder or quick-connect terminations
- Round design and colorful bezels
- Mounting on 35-mm-width DIN rails is made possible by using a special adapter
- Cycling trip-free mechanism



This product is recognized by Underwriters Laboratories under UL1077 as a "Supplementary Protector."

| Applicable Standards | Mark | Certification Organization / File No. |
|----------------------------|------|---------------------------------------|
| UL1077 | | UL recognized File No. E68029 |
| CSA C22.2 No. 235 (Note 1) | | CSA file No. LR83454 |
| EN60934 (Note 2) | | TÜV SÜD |
| GB17701 | | CCC No. 2005010309151798 |

For details, see the list of standard certified products in the back of this catalog.
 Note 1: Only NRF series circuit protectors without manual OFF mechanism are certified by CSA.
 Note 2: NRF110, rated current 8A, 10A, and 15A, without manual OFF mechanism

• Specify a rated current and the bezel color code in place of 1 2.

Package Quantity: 1

| Auxiliary Contact | Internal Circuit | Manual OFF Mechanism | Part No. | Standard | Designation Code | |
|-----------------------|------------------|----------------------|------------|-----------------------|--|---------------|
| | | | | | 1 Rated Current | 2 Bezel Color |
| w/o Auxiliary Contact | | Without | NRF110 2-1 | UL CSA CCC | 0.3A, 0.5A | |
| | | | NRF110 2-1 | UL CSA CCC TÜV (Note) | 1A, 2A, 3A, 5A, 8A, 10A, 15A | |
| | | With | NRF210 2-1 | UL CCC | 0.3A, 0.5A | |
| | | | NRF210 2-1 | UL CCC | 1A, 2A, 3A, 5A, 8A, 10A, 15A | |
| w/Auxiliary Contact | | Without | NRF111 2-1 | UL CSA CCC | 0.3A, 0.5A, 1A, 2A, 3A, 5A, 8A, 10A, 15A | |
| | | With | NRF211 2-1 | UL CCC | | |

| Bezel Color | Code |
|-------------|------------------------|
| Black | Blank (standard color) |
| Green | G |
| Red | R |
| Blue | S |
| White | W |
| Yellow | Y |

Note: TÜV approved models are for 8A, 10A, and 15A only. When ordering the TÜV approved models, specify "-EN" at the end of the Part No.

Part No. Development

When ordering, specify the Part No. the rated current, and the bezel color code.

[Example]

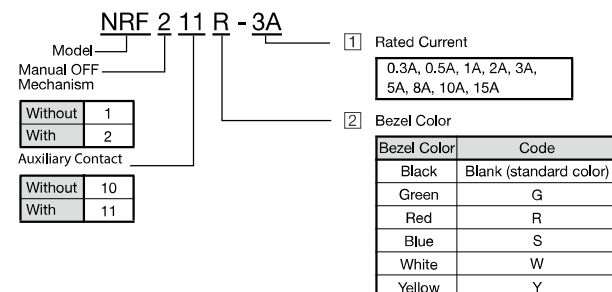

Wiring Example

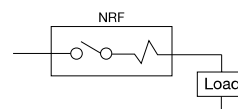

Manual OFF Mechanism

Manual OFF mechanism opens the main contacts by pressing the button, convenient for checking the circuit with power OFF. When manually turning OFF, make sure that the current is not applied (under no-load condition).

NRF Series Circuit Protectors

Specifications

| | |
|----------------------------|---|
| Protection Method | Thermal tripping |
| Internal Circuit | Series trip Series trip (w/auxiliary contact) |
| No. of Poles | 1 pole |
| Rated Voltage | 250V AC, 32V DC |
| Rated Current | 0.3A, 0.5A, 1A, 2A, 3A, 5A, 8A, 10A, 15A |
| Minimum Applicable Load | 24V AC/DC 100mA (reference value) |
| Rated Interrupting Current | 300 mA to 5A: Rated current × 6 8, 10, and 15A: Rated current × 10 (Turns on when the main circuit is off, including tripping.) |
| Auxiliary Contact Rating | 1NO (contact output) 125V AC / 32V DC, 50mA |
| Reference Temperature | 25°C |
| Operating Temperature | -10 to +60°C (no freezing) |
| Storage Temperature | -30 to +80°C (no freezing) |
| Operating Humidity | 45 to 85% RH (no condensation) (Note 1) |
| Storage Humidity | 45 to 85% RH (no condensation) |
| Trip Time (at 25 °C) | No trip at the rated current Within 1 hour at 135% the rated current |
| Reset Time | 60 sec minimum (Note 2) |
| Vibration Resistance | 100 m/s ² (10 to 55 Hz) |
| Shock Resistance | Damage limits: 1000 m/s ² , Operating extremes: 500 m/s ² |
| Life | Overcurrent durability: 1,000 operations minimum (tripping at 200% the rated current) Mechanical life (with manual OFF mechanism): 240 operations minimum (switching at no load) |
| Insulation Resistance | 100 MΩ minimum (500V DC megger) |
| Dielectric Strength | Between main contacts and between main contact and ground: 2000V AC, 1 minute Between main and auxiliary contacts: 1500V AC, 1 minute |
| Terminal Style | Main terminal: Tab terminal #250 Auxiliary contact terminal: 1.4W x 0.2mm thick solder terminal |
| Degree of Protection | IP40 (IEC 60529) |
| Weight (Approx.) | 15g |

Note 1: The rated current is the value at the reference ambient temperature of 25°C, and varies with the operating temperature. The rated current can be corrected according to the temperature correction curve.

Note 2: Reset time is the value at the reference ambient temperature of 25°C.

Time Delay Curves

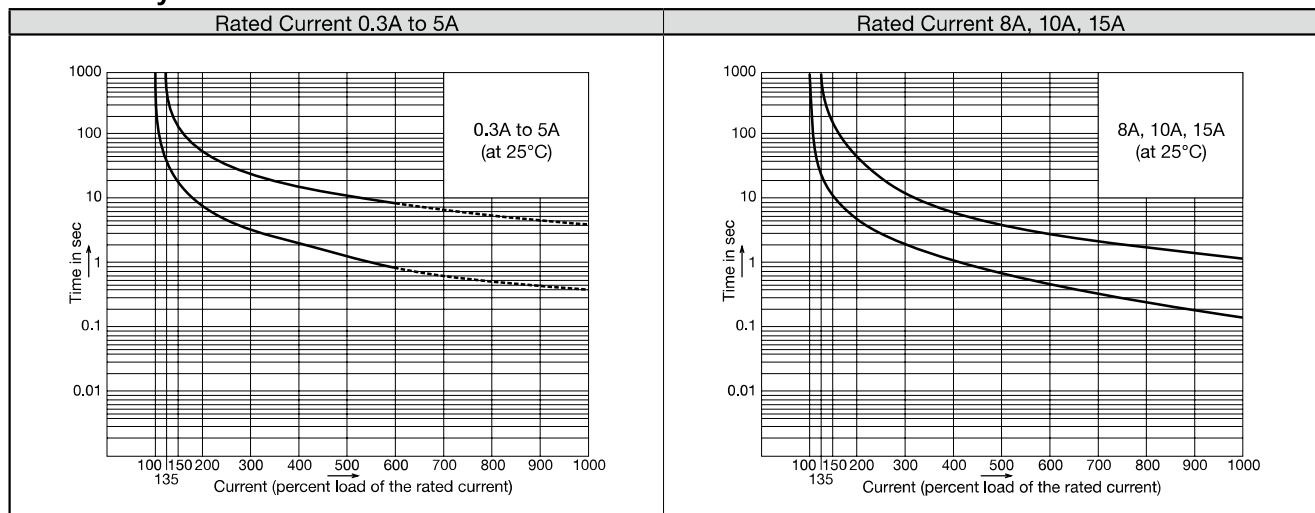

Note: Dashed lines are reference values.

Overcurrent Trip Time

0.3A to 5A

| Percent of Rated Current | 100% | 135% | 150% | 200% | 400% | 600% |
|--------------------------|---------|------------|-----------|---------|---------|------------|
| Trip Time (sec) | NO TRIP | 30 to 3600 | 16 to 120 | 7 to 55 | 2 to 17 | 0.9 to 8.5 |

(Ambient temperature + 25°C)

8 to 15A

| Percent of Rated Current | 100% | 135% | 150% | 200% | 400% | 600% | 800% | 1000% |
|--------------------------|---------|------------|-----------|---------|--------|-----------|-------------|-------------|
| Trip Time (sec) | NO TRIP | 28 to 3600 | 10 to 130 | 5 to 50 | 1 to 7 | 0.45 to 3 | 0.25 to 1.8 | 0.15 to 1.2 |

(Ambient temperature + 25°C)

Applications

NRF series circuit protectors are small, high-performance over-current protectors developed for use in control circuits and small electrical equipment. Because they can be easily reset, they are suited for use in relay circuits, motor circuits, heater circuits, transformers, solenoids, solenoid valves, semiconductor circuits, and many other applications.

[Application Examples]

Office Automation Equipment

Copiers, shredders, personal computers, word processors, fax machines, printers, computer terminals, communication equipment, and power supplies.

Measuring Instruments

Electrical measuring instruments, industrial meters, analyzers, recorders, data processors, test equipment, and chemical equipment

Industrial Machines

CNC equipment, robots, molding machines, processing machines, packaging machines, and carriers

Business machines

Medical equipment, vending machines, hairdresser's equipment, recreation and game machines, and small printing machines

Electric Controller and Instrumentation Equipment

Automatic control devices, electronic equipment, and instrumentation boards

Flush Silhouette

Switches & Pilot Lights

Display Lights

LED Illumination Units

Display Units

Safety Products

Terminal Blocks

Comm. Terminals

AS-Interface

Relays & Timers

Sockets

Circuit Protectors

Power Supplies

PLCs & SmartRelay

Operator Interfaces

Sensors

Control Stations

Explosion Protection

References

NRF Series Circuit Protectors

Rated Current vs Internal Resistance

| Rated Current | Internal Resistance (Ω) $\pm 15\%$ | Remarks |
|---------------|---|---------|
| 0.3A | 9.08 | at 25°C |
| 0.5A | 3.27 | |
| 1A | 0.81 | |
| 2A | 0.235 | |
| 3A | 0.0922 | |
| 5A | 0.0503 | |
| 8A | 0.0085 | |
| 10A | 0.0095 | |
| 15A | 0.0064 | |

The internal resistance tends to be larger for smaller rated currents. When the circuit protector is used in a low-voltage circuit, voltage drop should be taken into consideration.

Temperature Correction Curve

The rated current is based on an ambient temperature of 25°C. Since a thermal tripping method is employed, the rated current should be corrected according to the ambient temperature with reference to the curves shown below.

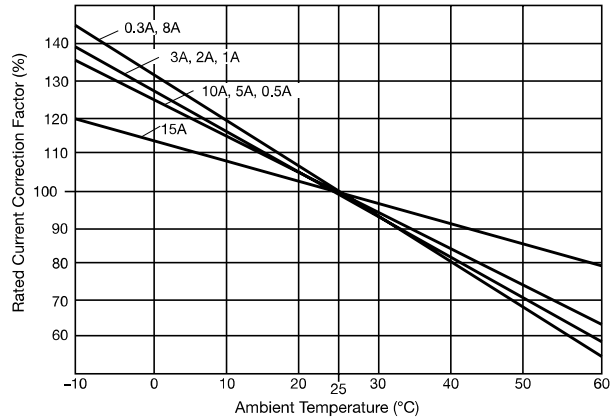

Dimensions

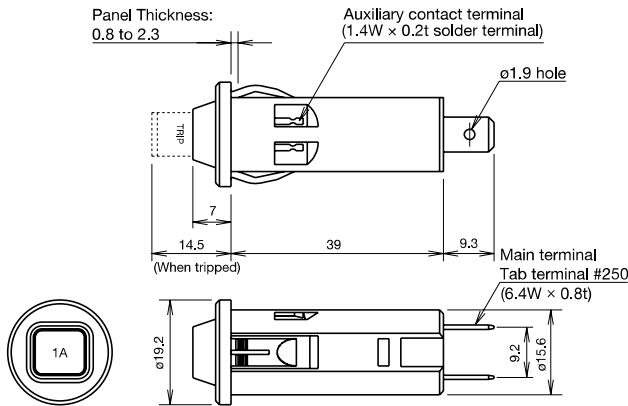

Mounting Hole

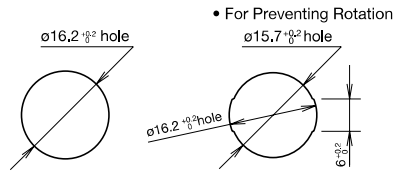

* Chamfering on the front edge of the mounting hole is recommended for easy insertion.

Accessories

35-mm-wide DIN Rail Mount Adapter

| Part No. | Ordering No. | Package Quantity |
|----------|--------------|------------------|
| NRF-D | NRF-DPN05 | 5 |

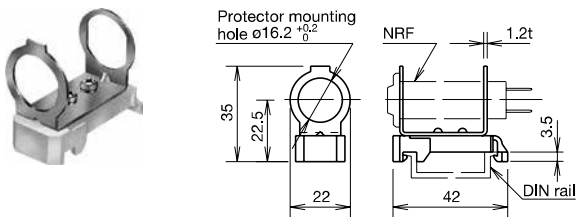

Surface Mount Adapter

| Part No. | Ordering No. | Package Quantity |
|----------|--------------|------------------|
| NRF-M | NRF-MPN10 | 10 |

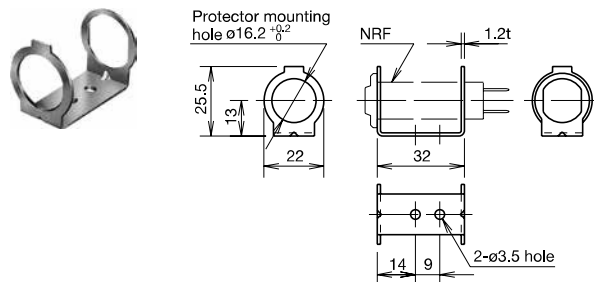

All dimension in mm.

Instructions

- Since the NRF is designed for protection against overload, it should be used within the rated interrupting current. An excessive overcurrent may affect the bimetal characteristics or damage the internal mechanism.
- After tripping, the NRF cannot be reset until the bimetal cools down. Allow the NRF at least 60 seconds before resetting. When the NRF is used at an ambient temperature higher than the reference temperature, resetting sometimes fails even after 60 seconds because it takes a long time to cool down the bimetal.
- The NRF may not trip at an instantaneous overcurrent due to its principle.
- The NRF is shipped in the ON status. To confirm operation of the models without manual OFF mechanism, apply approximately 200% the rated current to trip the NRF.
- When installing quick connect receptacles to the terminals, hold the NRF body and press it into the quick connect receptacles.
- Unlike conventional switches, the models with manual OFF mechanism are not suited for frequent switching due to their construction. (Their mechanical life is 240 operations at minimum when switching at no load.)
- The models with manual OFF mechanism should be operated without load.

Recommended Soldering Conditions

Solder the main terminal at a temperature of 390°C within 10 seconds using a 60W soldering iron. Solder the auxiliary/alarm terminal at a temperature of 350°C within 3 seconds using a 60W soldering iron. (Sn-Ag-Cu lead-free solder is recommended.) When solder-

ing, do not touch the circuit protector housing, auxiliary and alarm contacts with the soldering iron, and do not bend the terminals or pull the wires. Check your actual soldering conditions before solder-