

# NHD-C160100CZ-RN-FBW

## COG (Chip-On-Glass) Liquid Crystal Display Module

NHD-	Newhaven Display
C160100-	160 x 100 Pixels
CZ-	Model
R-	Reflective
N-	No Backlight
F-	FSTN Positive
B-	6:00 Optimal View
W-	Wide Temperature
	<b>RoHS Compliant</b>

**Newhaven Display International, Inc.**

2661 Galvin Ct.

Elgin IL, 60124

Ph: 847-844-8795

Fax: 847-844-8796

[www.newhavendisplay.com](http://www.newhavendisplay.com)

[nhtech@newhavendisplay.com](mailto:nhtech@newhavendisplay.com)

[nhsales@newhavendisplay.com](mailto:nhsales@newhavendisplay.com)

## Document Revision History

Revision	Date	Description	Changed by
0	6/17/2007	Initial Release	-
1	9/11/2009	User guide reformat	BE
2	10/14/2009	Updated Electrical Characteristic	MC
3	12/08/2009	Updated Block Diagram, Pins 4 and 5, and Timing Characteristics	MC
4	9/2/15	Mechanical drawing updated	AK
5	9/18/2015	Mechanical drawing updated	SB
6	8/9/16	LCD Glass supplier changed	AK
7	6/11/19	Pull Tab added to Drawing & Supply Current Updated	SB

## Functions and Features

- 160 x 100 pixels
- Built-in ST7528 controller
- Parallel 8080 interface
- +3.0V power supply
- 1/100 duty cycle; 1/11 bias
- RoHS Compliant

SYMBOL	REVISION	DATE

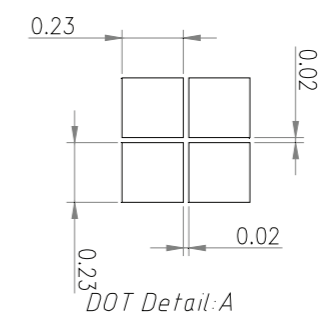
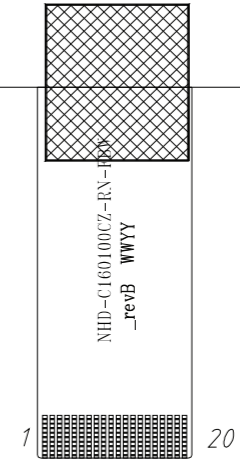
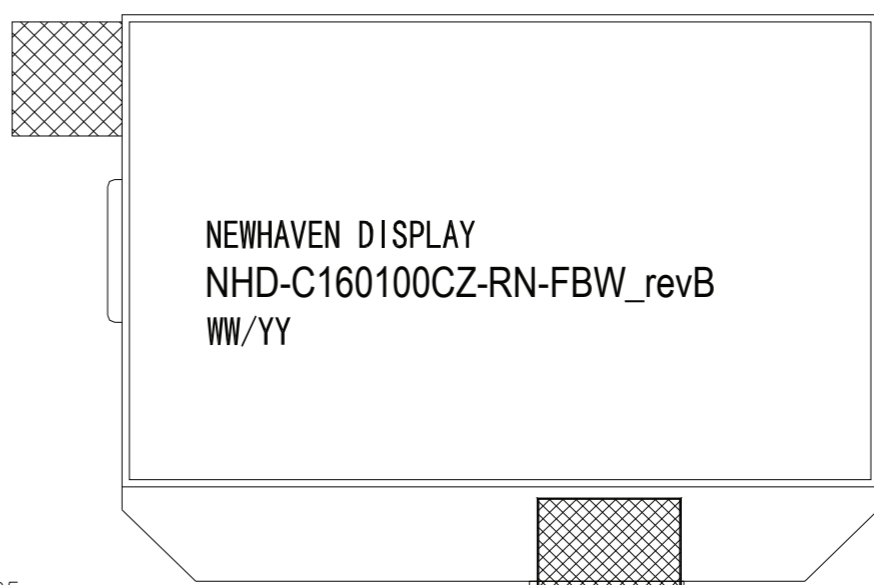
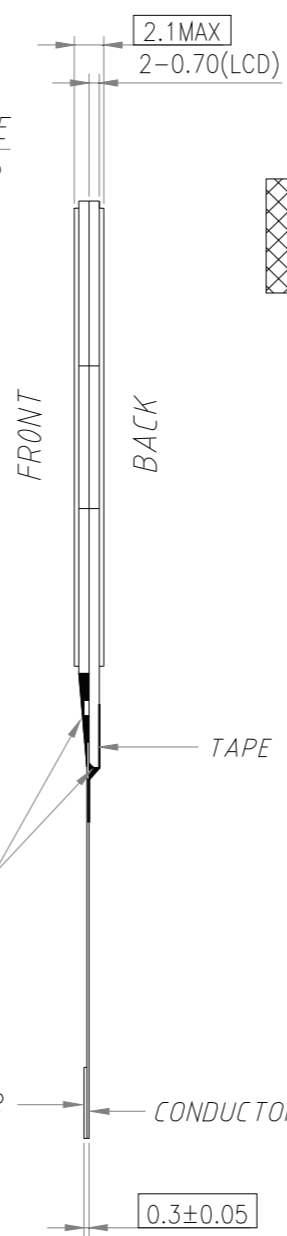
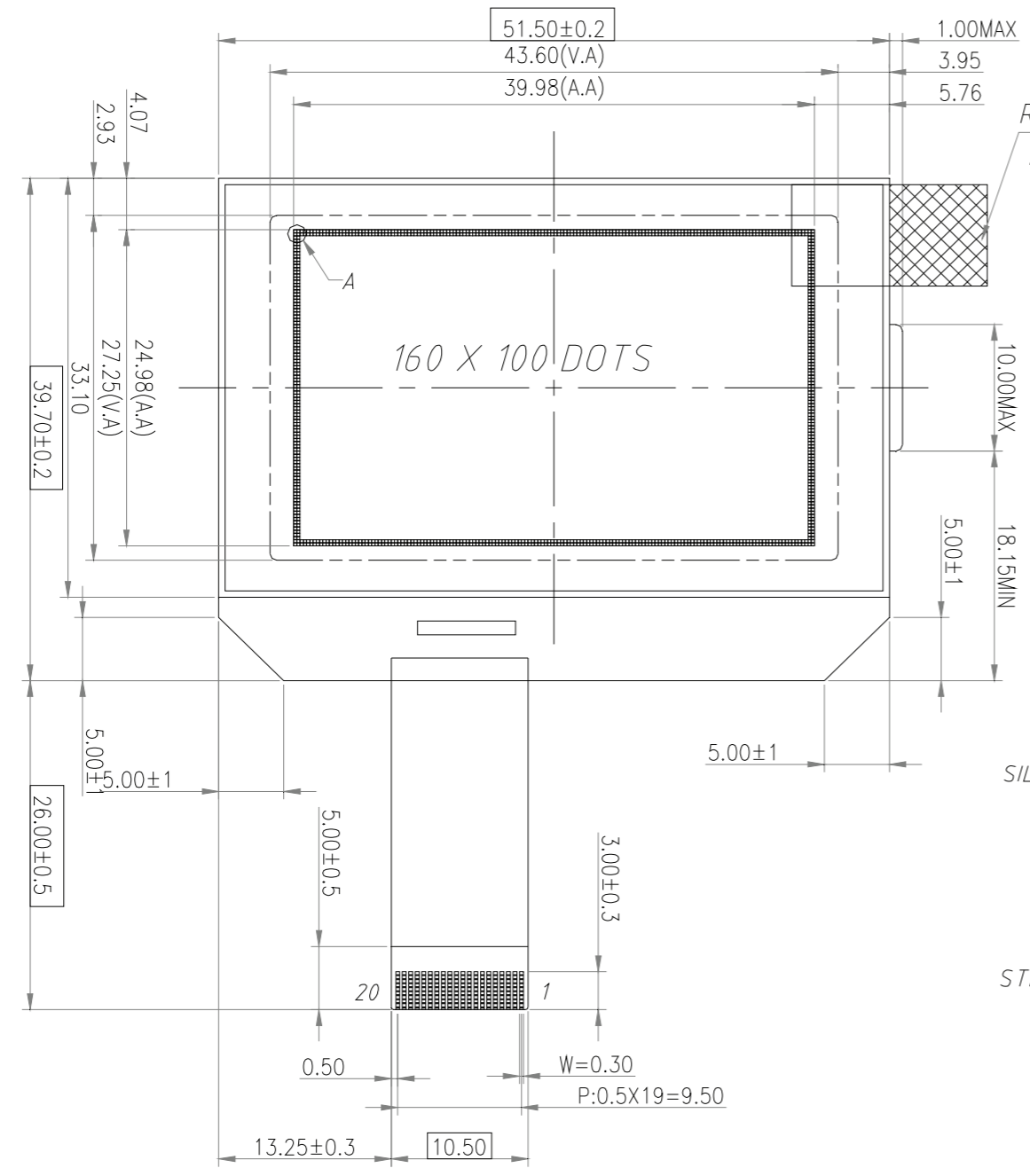

PIN	FUNCTION
1	CSB
2	RST
3	A0
4	/WR
5	/RD
6	DB0
7	DB1
8	DB2
9	DB3
10	DB4
11	DB5
12	DB6
13	DB7
14	VDD
15	VSS
16	VOUT
17	V4
18	V3
19	V2
20	V1

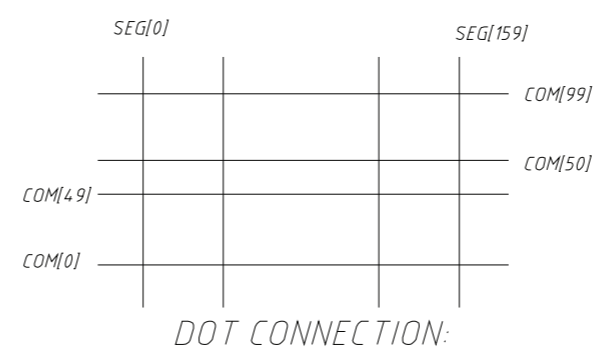

- Notes:**
- Display Type: FSTN / Positive / Reflective
  - VLCD: 11.5V ± 0.3V
  - Driver IC: ST7528
  - Operating Temp: -20°C to +70°C
  - Storage Temp: -30°C to +80°C
  - Optimal View: 6:00

STANDARD TOLERANCE: (UNLESS OTHERWISE SPECIFIED)	NEWHAVEN DISPLAY INTERNATIONAL	
	LINEAR: ±0.3mm	DRAWING/PART NUMBER: NHD-C160100CZ-RN-FBW
UNLESS OTHERWISE SPECIFIED: - DIMENSIONS ARE IN MILLIMETERS - THIRD ANGLE PROJECTION	DRAWN BY: S. Baxi	APPROVED BY: S. Baxi
	DRAWN DATE: 6/11/19	APPROVED DATE: 6/11/19
DO NOT SCALE DRAWING		REVISION: B SIZE: A3 SCALE: NS
THIS DRAWING IS SOLELY THE PROPERTY OF NEWHAVEN DISPLAY INTERNATIONAL, INC. THE INFORMATION IT CONTAINS IS NOT TO BE DISCLOSED, REPRODUCED OR COPIED IN WHOLE OR PART WITHOUT WRITTEN APPROVAL FROM NEWHAVEN DISPLAY.		

## Pin Description and Wiring Diagram

Pin No.	Symbol	External Connection	Function Description
1	CSB	MPU	Active LOW Chip Select signal
2	RST	MPU	Active LOW Reset signal
3	A0	MPU	Register Select signal. A0=1: Data, A0=0: Command
4	/WR	MPU	Active LOW Write signal
5	/RD	MPU	Active LOW Read signal
6-13	DB0-DB7	MPU	Bi-directional 8-bit data bus.
14	V <sub>DD</sub>	Power Supply	Supply voltage for LCD and logic (+3.0V)
15	V <sub>SS</sub>	Power Supply	Ground
16	V <sub>OUT</sub>	Power Supply	Connect to 1uF cap to V <sub>SS</sub> or V <sub>DD</sub>
17	V <sub>4</sub>	Power Supply	1.0uF-2.2uF cap to V <sub>SS</sub>
18	V <sub>3</sub>	Power Supply	1.0uF-2.2uF cap to V <sub>SS</sub>
19	V <sub>2</sub>	Power Supply	1.0uF-2.2uF cap to V <sub>SS</sub>
20	V <sub>1</sub>	Power Supply	1.0uF-2.2uF cap to V <sub>SS</sub>

**Recommended LCD connector:** 0.5mm pitch pins. Molex p/n: 52746-2070

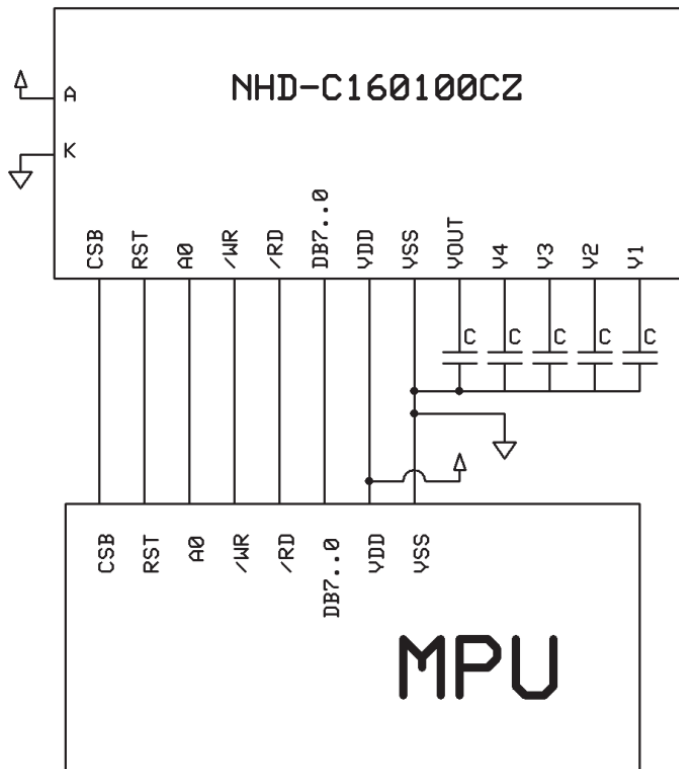

## Electrical Characteristics

Item	Symbol	Condition	Min.	Typ.	Max.	Unit
Operating Temperature Range	T <sub>OP</sub>	Absolute Max	-20	-	+70	°C
Storage Temperature Range	T <sub>ST</sub>	Absolute Max	-30	-	+80	°C
Supply Voltage	V <sub>DD</sub>	-	2.7	3.0	3.3	V
Supply Current	I <sub>DD</sub>	T <sub>OP</sub> =25°C, V <sub>DD</sub> =3.0V	0.38	0.75	1.13	mA
Supply for LCD (contrast)	V <sub>LCD</sub>		11.2	11.5	11.8	V
"H" Level input	V <sub>IH</sub>	-	0.7*V <sub>DD</sub>	-	V <sub>DD</sub>	V
"L" Level input	V <sub>IL</sub>	-	V <sub>SS</sub>	-	0.3*V <sub>DD</sub>	V
"H" Level output	V <sub>OH</sub>	-	0.7*V <sub>DD</sub>	-	V <sub>DD</sub>	V
"L" Level output	V <sub>OL</sub>	-	V <sub>SS</sub>	-	0.3*V <sub>DD</sub>	V

## Optical Characteristics

Item	Symbol	Condition	Min.	Typ.	Max.	Unit
Optimal Viewing Angles	Top	CR≥2	-	20	-	°
	Bottom		-	40	-	°
	Left		-	45	-	°
	Right		-	45	-	°
Contrast Ratio	CR	-	2	4	-	-
Response Time	Rise	T <sub>OP</sub> = 25°C	-	70	104	ms
	Fall		-	140	215	ms

## Controller Information

Built-in ST7528 controller.

Please download specification at [http://www.newhavendisplay.com/app\\_notes/ST7528.pdf](http://www.newhavendisplay.com/app_notes/ST7528.pdf)

## Table of Commands

Instruction	A0	RW	DB7	DB6	DB5	DB4	DB3	DB2	DB1	DB0	Description
<b>EXT=0 or 1</b>											
Mode Set	0	0	0	0	1	1	1	0	0	0	2-byte instruction to set Mode and FR( Frame frequency control) BE( Booster efficiency control)
	0	0	FR3	FR2	FR1	FR0	0	BE	x'	EXT	
<b>EXT=0</b>											
Read display data	1	1	Read data							Read data into DDRAM	
Write display data	1	0	Write data							Write data into DDRAM	
Read status	0	1	BUSY	ON	RES	MF2	MF1	MF0	DS1	DS0	Read the internal status
ICON control register ON/OFF	0	0	1	0	1	0	0	0	1	ICON	ICON=0: ICON disable(default) ICON=1: ICON enable & set the page address to 16
Set page address	0	0	1	0	1	1	P3	P2	P1	P0	Set page address
Set column address MSB	0	0	0	0	0	1	Y9	Y8	Y7	Y6	Set column address MSB
Set column address LSB	0	0	0	0	0	0	Y5	Y4	Y3	Y2	Set column address LSB
Set modify-read	0	0	1	1	1	0	0	0	0	0	Set modify-read mode
Reset modify-read	0	0	1	1	1	0	1	1	1	0	release modify-read mode
Display ON/OFF	0	0	1	0	1	0	1	1	1	D	D=0: Display OFF D=1: Display ON
Set initial display line register	0	0	0	1	0	0	0	0	x'	x'	2-byte instruction to specify the initial display line to realize vertical scrolling
	0	0	x'	S6	S5	S4	S3	S2	S1	S0	
Set initial COM0 register	0	0	0	1	0	0	0	1	x'	x'	2-byte instruction to specify the initial COM0 to realize window scrolling
	0	0	x'	C6	C5	C4	C3	C2	C1	C0	
Set partial display duty ration	0	0	0	1	0	0	1	0	x'	x'	2-byte instruction to set partial display duty ratio
	0	0	D7	D6	D5	D4	D3	D2	D1	D0	
Set N-line inversion	0	0	0	1	0	0	1	1	x'	x'	2-byte instruction to set N-line inversion register
	0	0	x'	x'	x'	N4	N3	N2	N1	N0	
Release N-line inversion	0	0	1	1	1	0	0	1	0	0	Release N-line inversion mode
Reverse display ON/OFF	0	0	1	0	1	0	0	1	1	REV	REV=0: normal display REV=1: reverse display
Entire display ON/OFF	0	0	1	0	1	0	0	1	0	EON	EON=0: normal display EON=1: entire display ON

Instruction	A0	RW	DB7	DB6	DB5	DB4	DB3	DB2	DB1	DB0	Description
<b>Ext=0</b>											
Power control	0	0	0	0	1	0	1	VC	VR	VF	Control power circuit operation
Select DC-DC step-up	0	0	0	1	1	0	0	1	DC1	DC0	Select the step-up of internal voltage converter
Select regulator register	0	0	0	0	1	0	0	R2	R1	R0	Select the internal resistance ratio of the regulator resistor
Select electronic volumn register	0	0	1	0	0	0	0	0	0	1	2-byte instruction to specify the reference voltage
	0	0	x'	x'	EV5	EV4	EV3	EV2	EV1	EV0	
Select LCD bias	0	0	0	1	0	1	0	B2	B1	B0	Select LCD bias
Set Bias Power Save Mode	0	0	1	1	1	1	0	0	1	1	Bias Power save Save the Bias current consumption
	0	0	0	0	0	0	0	0	0	0	
Release Bias Power Save Mode	0	0	1	1	1	1	0	0	1	1	Bias Power save release set the Bias power to normal
	0	0	0	0	0	0	0	1	0	0	
SHL select	0	0	1	1	0	0	SHL	x'	x'	x'	COM bi-directional selection SHL=0: normal direction SHL=1: reverse direction
ADC select	0	0	1	0	1	0	0	0	0	ADC	SEG bi-direction selection ADC=0: normal direction ADC=1: reverse direction
Oscillator on start	0	0	1	0	1	0	1	0	1	1	Start the built-in oscillator
Set power save mode	0	0	1	0	1	0	1	0	0	P	P=0: normal mode P=1: sleep mode
Release power save mode	0	0	1	1	1	0	0	0	0	1	release power save mode
Reset	0	0	1	1	1	0	0	0	1	0	initial the internal function
Set data direction & display data length(DDL)	x'	x'	1	1	1	0	1	0	0	0	2-byte instruction to specify the number of data bytes. (SPI mode)
	x'	x'	D7	D6	D5	D4	D3	D2	D1	D0	
Select FRC and PWM mode	0	0	1	0	0	1	0	FRC	PWM1	PWM0	FRC(1:3FRC, 0:4FRC) PWM1 PWM0 0 0 45PWM 0 1 45 PWM 1 0 60PWM 1 1 ---
NOP	0	0	1	1	1	0	0	0	1	1	<u>No operation</u>
Test Instruction	0	0	1	1	1	1	x'	x'	x'	x'	<u>Don't use this instruction</u>

Instruction	A0	RW	DB7	DB6	DB5	DB4	DB3	DB2	DB1	DB0	Description
<b>EXT=1</b>											
Set white mode and 1 <sup>st</sup> frame, set pulse width	0	0	1	0	0	0	0	0	0	0	Set white mode and 1st frame
	0	0	X'	X'	GA05	GA04	GA03	GA02	GA01	GA00	
Set white mode and 2 <sup>nd</sup> frame, set pulse width	0	0	1	0	0	0	0	0	0	1	Set white mode and 2nd frame
	0	0	X'	X'	GA05	GA04	GA03	GA02	GA01	GA00	
Set white mode and 3 <sup>rd</sup> frame, set pulse width	0	0	1	0	0	0	0	0	1	0	Set white mode and 3rd frame
	0	0	X'	X'	GA05	GA04	GA03	GA02	GA01	GA00	
Set white mode and 4 <sup>th</sup> frame, set pulse width	0	0	1	0	0	0	0	0	1	1	Set white mode and 4th frame
	0	0	X'	X'	GA05	GA04	GA03	GA02	GA01	GA00	
Set gray level 1 mode	0	0	84H~87H (4 bytes)								Set gray level1
Set gray level 2 mode	0	0	88H~8BH (4 bytes)								Set gray level2
Set gray level 3 mode	0	0	8CH~8FH (4bytes)								Set gray level3
Set gray level 4 mode	0	0	90H~93H (4bytes)								Set gray level4
Set gray level 5 mode	0	0	94H~97H (4bytes)								Set gray level5
Set gray level 6 mode	0	0	98H~9BH (4 bytes)								Set gray level6
Set gray level 7 mode	0	0	9CH~9FH (4 bytes)								Set gray level7
Set gray level 8 mode	0	0	A0H~A3H (4 bytes)								Set gray level8
Set gray level 9 mode	0	0	A4H~A7H (4 bytes)								Set gray level9
Set gray level 10 mode	0	0	A8H~ABH (4 bytes)								Set gray level10
Set gray level 11mode	0	0	ACH~AFH (4 bytes)								Set gray level11
Set gray level 12 mode	0	0	B0H~B3H (4 bytes)								Set gray level12
Set gray level 13 mode	0	0	B4H~B7H (4 bytes)								Set gray level13
Set gray level 14 mode	0	0	B8H~BBH (4 bytes)								Set gray level14
Set Dark mode and 1st frame, set pulse width	0	0	1	0	1	1	1	1	0	0	Set Dark mode and 1st frame, set pulse width
	0	0	X'	X'	GAF5	GAF4	GAF3	GAF2	GAF1	GAF0	
Set Dark mode and 2nd frame, set pulse width	0	0	1	0	1	1	1	1	0	1	Set Dark mode and 2nd frame, set pulse width
	0	0	X'	X'	GAF5	GAF4	GAF3	GAF2	GAF1	GAF0	
Set Dark mode and 3rd frame, set pulse width	0	0	1	0	1	1	1	1	1	0	Set Dark mode and 3rd frame, set pulse width
	0	0	X'	X'	GAF5	GAF4	GAF3	GAF2	GAF1	GAF0	
Set Dark mode and 4th frame, set pulse width	0	0	1	0	1	1	1	1	1	1	Set Dark mode and 4th frame, set pulse width
	0	0	X'	X'	GAF5	GAF4	GAF3	GAF2	GAF1	GAF0	



# Timing Characteristics

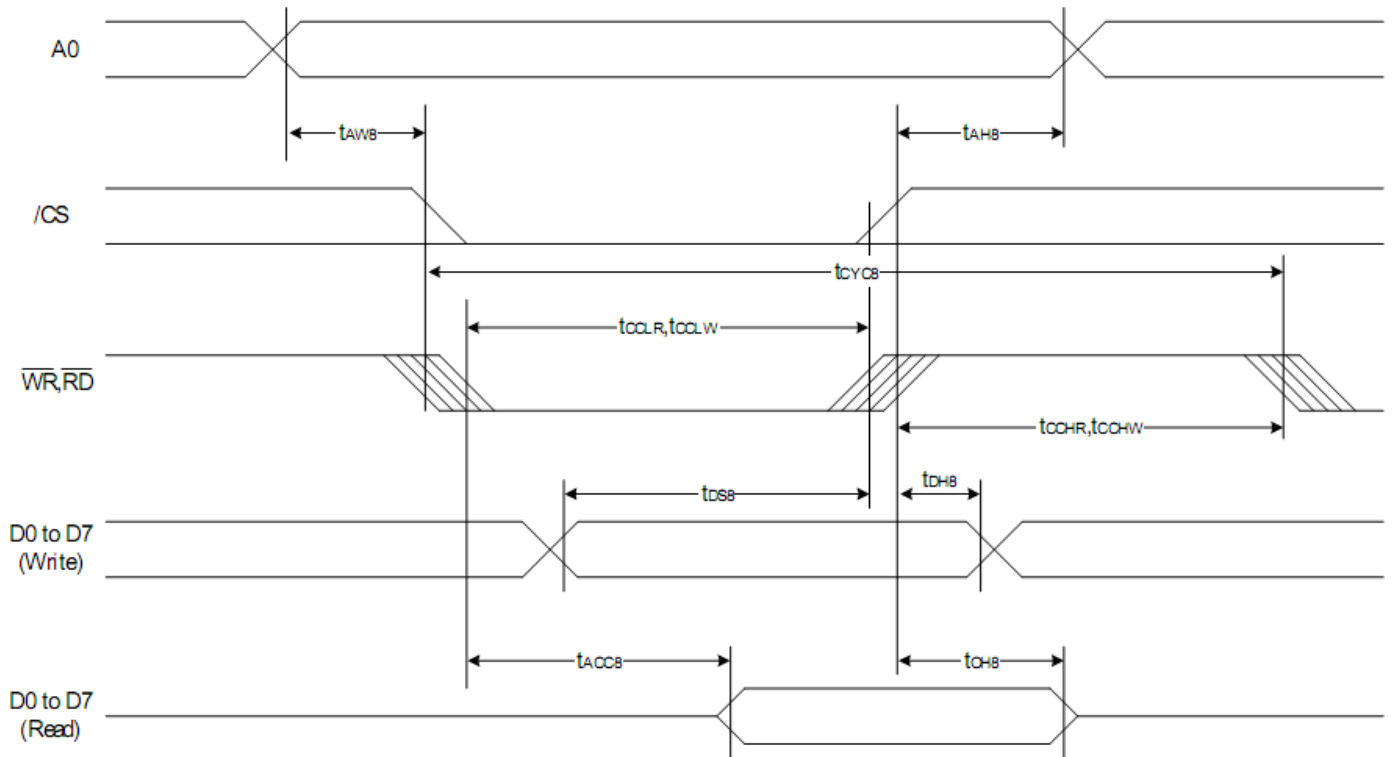

(VDD = 3.3V , Ta =25°C)

Item	Signal	Symbol	Condition	Rating		Units
				Min.	Max.	
Address hold time	A0	tAH8		0	—	ns
Address setup time		tAW8		0	—	
System cycle time		tCYC8		240	—	
Enable L pulse width (WRITE)	WR	tCCLW		80	—	
Enable H pulse width (WRITE)		tCCHW		80	—	
Enable L pulse width (READ)	RD	tCCLR		140	—	
Enable H pulse width (READ)		tCCHR		80	—	
WRITE Data setup time	D0 to D7	tDS8		40	—	
WRITE Data hold time		tDH8		10	—	
READ access time		tACC8	CL = 100 pF	—	70	
READ Output disable time		tOH8	CL = 100 pF	5	50	

## Example Initialization Program

```
//-----  
void write_command(unsigned char datum)  
{  
    A0=0; /*Instruction register*/  
    E=1; /*Read inactive*/  
    P1 = datum; /*put data on port 1*/  
    CS1=0; /*Chip select active*/  
    RW=0; /*Write active*/  
    RW=1; /*Write inactive; latch in data*/  
    CS1=1; /*Chip select inactive*/  
}  
  
//-----  
void write_data(unsigned char datum)  
{  
    A0=1; /*DDRAM data register*/  
    E=1;  
    P1=datum;  
    CS1=0;  
    RW=0;  
    RW=1;  
    CS1=1;  
}  
  
//-----  
void lcd_init(void){  
    write_command(0xA2); //ICON OFF;  
    write_command(0xAE); //Display OFF  
  
    write_command(0x48); //Set Duty ratio  
    write_command(0x80); //No operation  
    write_command(0xa1); //Set scan direction //changed from 0 to 1  
    write_command(0xc8); //SHL select  
    write_command(0x40); //Set START LINE  
    write_command(0x00);  
    write_command(0xab); //OSC on  
  
    write_command(0x64); //3x  
    delay(2000);  
    write_command(0x65); //4x  
    delay(2000);  
    write_command(0x66); //5x  
    delay(2000);  
    write_command(0x67); //6x  
    delay(2000);  
  
    write_command(Ra_Rb); //RESISTER SET  
    write_command(0x81); //Set electronic volume register  
    write_command(vopcode); //n=0~3f  
  
    write_command(0x57); //1/12bias  
    write_command(0x92); //FRC and pwm  
  
    write_command(0x2C);  
    delay(20000); //200ms
```

```
write_command(0x2E);
delay(20000);//200ms
write_command(0x2F);
delay(20000);//200ms
```

```
write_command(0x92); //frc and pwm
write_command(0x38); //external mode
write_command(0x75);
//start settings for 16-level grayscale
write_command(0x97); //3frc,45pwm
```

```
write_command(0x80);
write_command(0x00);
write_command(0x81);
write_command(0x00);
write_command(0x82);
write_command(0x00);
write_command(0x83);
write_command(0x00);
```

```
write_command(0x84);
write_command(0x06);
write_command(0x85);
write_command(0x06);
write_command(0x86);
write_command(0x06);
write_command(0x87);
write_command(0x06);
```

```
write_command(0x88);
write_command(0x0b);
write_command(0x89);
write_command(0x0b);
write_command(0x8a);
write_command(0x0b);
write_command(0x8b);
write_command(0x0b);
```

```
write_command(0x8c);
write_command(0x10);
write_command(0x8d);
write_command(0x10);
write_command(0x8e);
write_command(0x10);
write_command(0x8f);
write_command(0x10);
```

```
write_command(0x90);
write_command(0x15);
write_command(0x91);
write_command(0x15);
write_command(0x92);
write_command(0x15);
write_command(0x93);
write_command(0x15);
```

```
write_command(0x94);
write_command(0x1a);
write_command(0x95);
write_command(0x1a);
write_command(0x96);
write_command(0x1a);
```

```
write_command(0x97);  
write_command(0x1a);
```

```
write_command(0x98);  
write_command(0x1e);  
write_command(0x99);  
write_command(0x1e);  
write_command(0x9a);  
write_command(0x1e);  
write_command(0x9b);  
write_command(0x1e);
```

```
write_command(0x9c);  
write_command(0x23);  
write_command(0x9d);  
write_command(0x23);  
write_command(0x9e);  
write_command(0x23);  
write_command(0x9f);  
write_command(0x23);
```

```
write_command(0xa0);  
write_command(0x27);  
write_command(0xa1);  
write_command(0x27);  
write_command(0xa2);  
write_command(0x27);  
write_command(0xa3);  
write_command(0x27);
```

```
write_command(0xa4);  
write_command(0x2b);  
write_command(0xa5);  
write_command(0x2b);  
write_command(0xa6);  
write_command(0x2b);  
write_command(0xa7);  
write_command(0x2b);
```

```
write_command(0xa8);  
write_command(0x2f);  
write_command(0xa9);  
write_command(0x2f);  
write_command(0xaa);  
write_command(0x2f);  
write_command(0xab);  
write_command(0x2f);
```

```
write_command(0xac);  
write_command(0x32);  
write_command(0xad);  
write_command(0x32);  
write_command(0xae);  
write_command(0x32);  
write_command(0xaf);  
write_command(0x32);
```

```
write_command(0xb0);  
write_command(0x35);  
write_command(0xb1);  
write_command(0x35);  
write_command(0xb2);  
write_command(0x35);
```

```
write_command(0xb3);
write_command(0x35);

write_command(0xb4);
write_command(0x38);
write_command(0xb5);
write_command(0x38);
write_command(0xb6);
write_command(0x38);
write_command(0xb7);
write_command(0x38);

write_command(0xb8);
write_command(0x3a);
write_command(0xb9);
write_command(0x3a);
write_command(0xba);
write_command(0x3a);
write_command(0xbb);
write_command(0x3a);

write_command(0xbc);
write_command(0x3c);
write_command(0xbd);
write_command(0x3c);
write_command(0xbe);
write_command(0x3c);
write_command(0xbf);
write_command(0x3c);
    //end settings for 16-level grayscale
write_command(0x38);
write_command(0x74);
write_command(0xaf); //Display ON
}

//-----
```

## Quality Information

Test Item	Content of Test	Test Condition	Note
High Temperature storage	Endurance test applying the high storage temperature for a long time.	+80°C , 48hrs	2
Low Temperature storage	Endurance test applying the low storage temperature for a long time.	-30°C , 48hrs	1,2
High Temperature Operation	Endurance test applying the electric stress (voltage & current) and the high thermal stress for a long time.	+70°C 48hrs	2
Low Temperature Operation	Endurance test applying the electric stress (voltage & current) and the low thermal stress for a long time.	-20°C , 48hrs	1,2
High Temperature / Humidity Operation	Endurance test applying the electric stress (voltage & current) and the high thermal with high humidity stress for a long time.	+40°C , 90% RH , 48hrs	1,2
Thermal Shock resistance	Endurance test applying the electric stress (voltage & current) during a cycle of low and high thermal stress.	-0°C,30min -> 25°C,5min -> 50°C,30min = 1 cycle 10 cycles	
Vibration test	Endurance test applying vibration to simulate transportation and use.	10-55Hz , 15mm amplitude. 60 sec in each of 3 directions X,Y,Z For 15 minutes	3
Static electricity test	Endurance test applying electric static discharge.	VS=800V, RS=1.5kΩ, CS=100pF One time	

**Note 1:** No condensation to be observed.

**Note 2:** Conducted after 4 hours of storage at 25°C, 0%RH.

**Note 3:** Test performed on product itself, not inside a container.

## Precautions for using LCDs/LCMs

See Precautions at [www.newhavendisplay.com/specs/precautions.pdf](http://www.newhavendisplay.com/specs/precautions.pdf)

## Warranty Information and Terms & Conditions

[http://www.newhavendisplay.com/index.php?main\\_page=terms](http://www.newhavendisplay.com/index.php?main_page=terms)