

Product Specification

NHD-3.5-320240JF-ASXP-CTP

TFT Liquid Crystal Display

NHD -	Newhaven Display
3.5 -	3.5" Diagonal
320240 -	320xRGBx240 Pixels
JF -	Model
A -	Built-in Driver / No Controller
S -	High Brightness, White LED Backlight
X -	TFT
P -	IPS, Wide Temperature
CTP -	Capacitive Touch Panel with Controller

Table of Contents

Document Revision History.....	2
Mechanical Drawing	3
Pin Description	4
RGB Interface Mode Selection	5
Electrical Characteristics	6
Optical Characteristics:	6
Capacitive Touch Panel Material Characteristics:.....	7
Driver/Controller Information	7
Capacitive Touch Panel Registers	8
AC Characteristics	11
Timing Characteristics – TFT Display.....	12
Timing Characteristics – Capacitive Touch Panel.....	17
Quality Information	21

Additional Resources

- **Support Forum:** <https://support.newhavendisplay.com/hc/en-us/community/topics>
- **GitHub:** <https://github.com/newhavendisplay>
- **Example Code:** <https://support.newhavendisplay.com/hc/en-us/categories/4409527834135-Example-Code/>
- **Knowledge Center:** https://www.newhavendisplay.com/knowledge_center.html
- **Quality Center:** https://www.newhavendisplay.com/quality_center.html
- **Precautions for using LCDs/LCMs:** <https://www.newhavendisplay.com/specs/precautions.pdf>
- **Warranty / Terms & Conditions:** <https://www.newhavendisplay.com/terms.html>



Document Revision History

Revision	Date	Description	Changed By
0	05/13/2022	Initial Release	JT
1	06/08/2022	Updated to add the RGB Interface Mode Selection section	CJ
2	06/09/2022	Updated Optical Characteristics, Capacitive Touch Panel Material Characteristics and Mechanical Drawing	CJ
3	10/20/2022	CTP Gesture ID Values Updated	KL
4	01/04/2023	Added Timing Characteristics and Example Code for Capacitive Touch Panel	KL

Mechanical Drawing

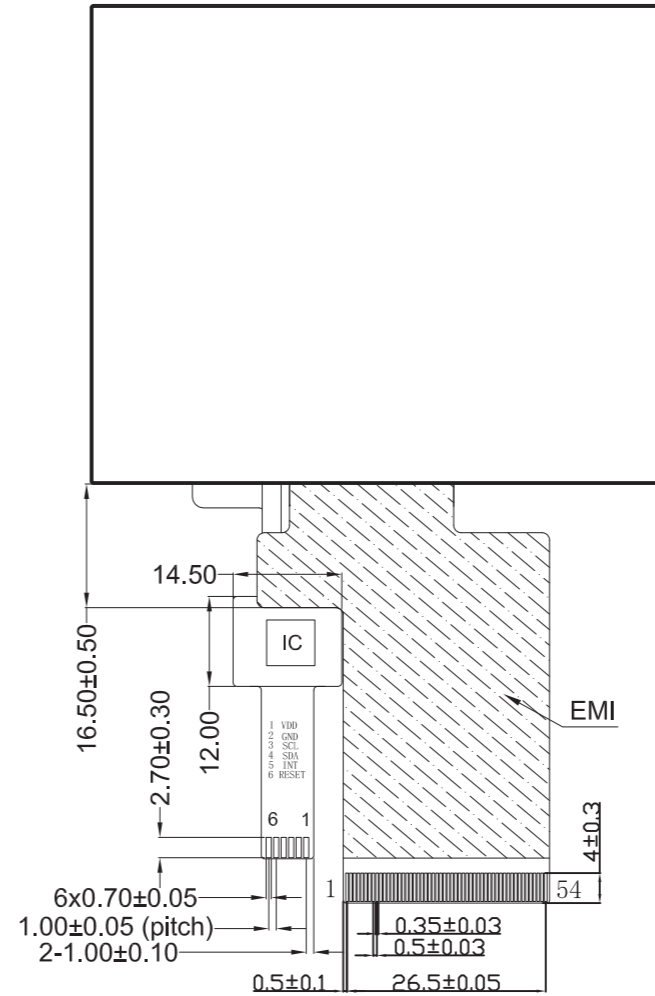
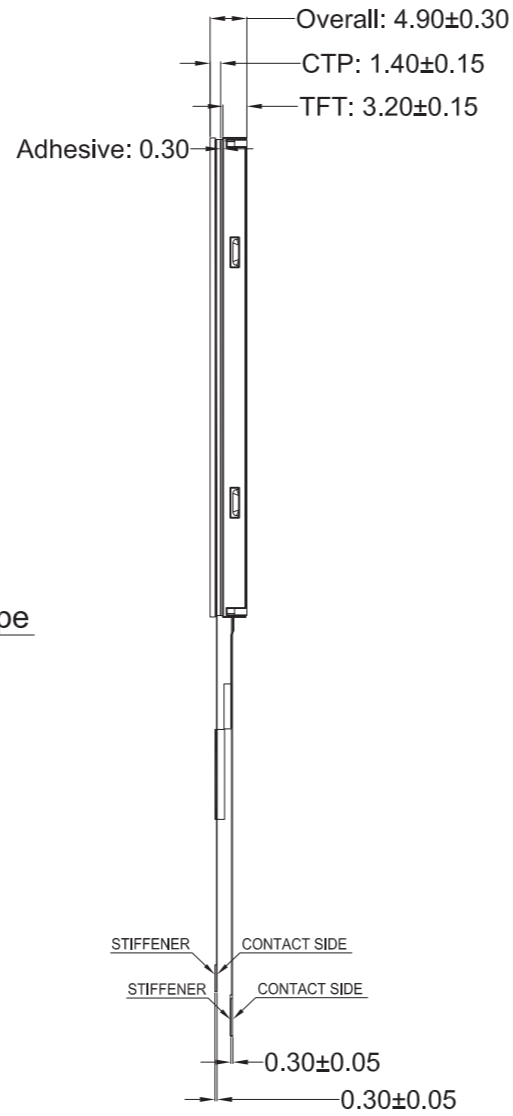
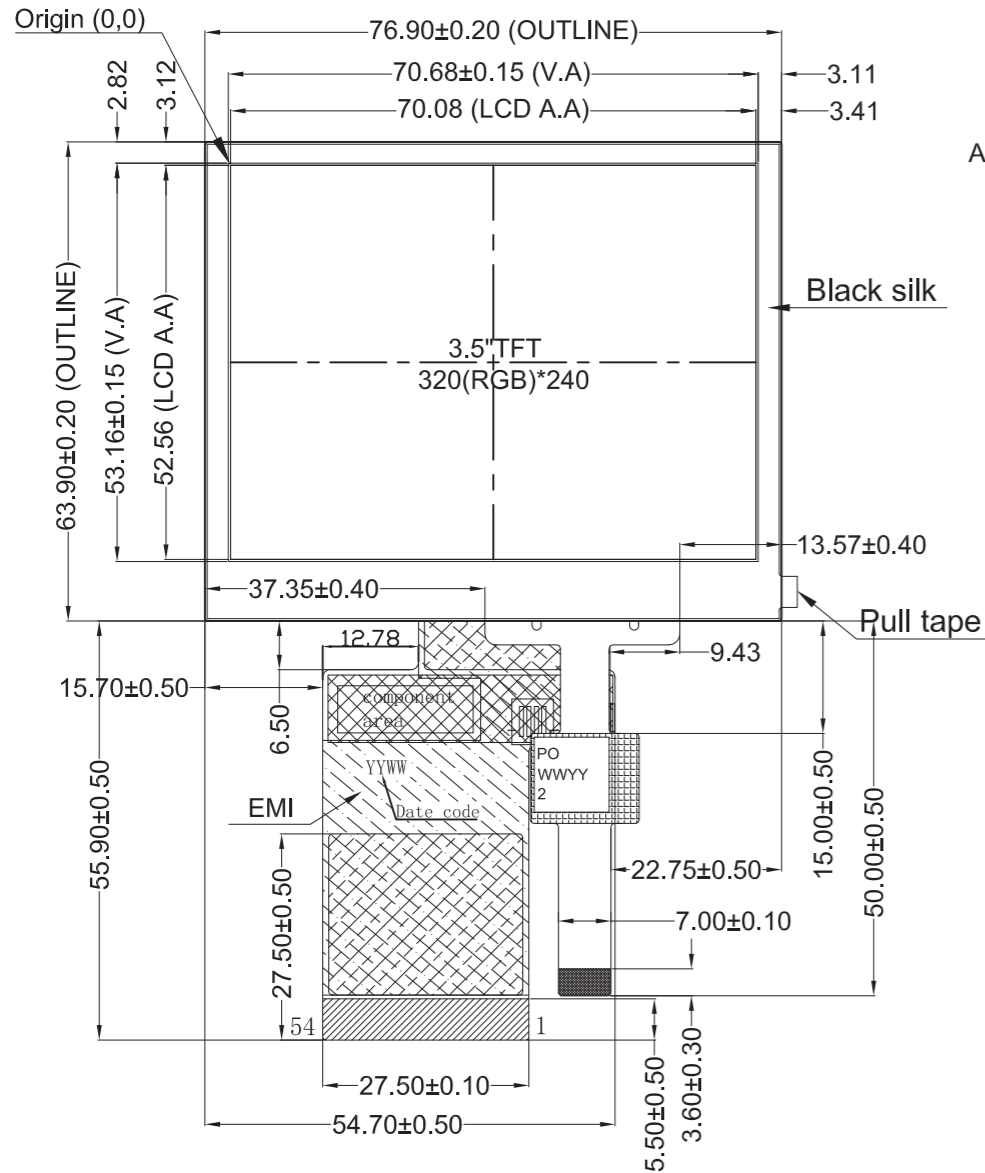

Newhaven Display

NHD-3.5-320240JF-ASXP-CTP

Date Code

Part Label (type/format may vary)

TFT

Pin No.	Symbol
1	LED_K
2	LED_K
3	LED_A
4	LED_A
5	NC
6	NC
7	NC
8	RSTB
9	SPENB
10	SPCK
11	SPDA
12-19	B0-B7
20-27	G0-G7
28-35	R0-R7
36	HSD
37	VSD
38	CLKIN
39	NC
40	NC
41	VDD
42	VDD
43	NC
44	NC
45	NC
46	NC
47	NC
48	NC
49	NC
50	NC
51	NC
52	DEN
53	GND
54	GND

CTP

Pin No.	Symbol
1	VDD
2	GND
3	SCL
4	SDA
5	INT
6	RESET

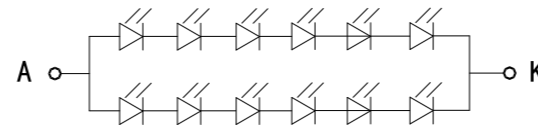

LED CIRCUIT DIAGRAM

Product Description: 3.5" 320x240 IPS TFT w/ Capacitive Touch

1. Driver IC: ST7272A TFT, FT5426 CTP
2. Interface: 24-Bit Parallel RGB TFT, I²C CTP
3. Optical Features: Normally Black, Transmissive, 900 cd/m²
4. Power Requirements: 3.3V TFT, 18.6V/40mA Backlight, 3.0V CTP
5. Recommended FFC Connector:
TFT: 54pin 0.5mm pitch; EX. Molex 51296-5494
CTP: 6pin 1.0mm pitch; EX. Molex 52271-0679
6. EMI Shielded FPC

Standard Tolerance: (Unless otherwise specified) Linear: ±0.3mm		
	Drawing/Part Number: NHD-3.5-320240JF-ASXP-CTP	Revision: -
Unless otherwise specified: • Dimensions are in Millimeters • Third Angle Projection	Drawn By: K. Lewis Drawn Date: 11/16/2022	Approved By: K. Lewis Approved Date: 11/16/2022
This drawing is solely the property of Newhaven Display International, Inc. The information it contains is not to be disclosed, reproduced or copied in whole or part without written approval from Newhaven Display.		

Pin Description

TFT:

Pin No.	Symbol	External Connection	Function Description
1	LED_K	Power Supply	Backlight Cathode (Ground)
2	LED_K	Power Supply	Backlight Cathode (Ground)
3	LED_A	Power Supply	Backlight Anode (40mA @ 18.6V)
4	LED_A	Power Supply	Backlight Anode (40mA @ 18.6V)
5	NC	-	No Connect
6	NC	-	No Connect
7	NC	-	No Connect
8	RSTB	MPU	Active LOW Reset signal
9	SPENB	MPU	Active LOW Serial Chip Select signal
10	SPCK	MPU	Serial Clock signal
11	SPDA	MPU	Serial Data signal
12-19	B0-B7	MPU	Blue Data signals
20-27	G0-G7	MPU	Green Data signals
28-35	R0-R7	MPU	Red Data signals
36	HSD	MPU	Horizontal (Line) Sync signal
37	VSD	MPU	Vertical (Frame) Sync signal
38	CLKIN	MPU	Dot Clock signal
39-40	NC	-	No Connect
41	VDD	Power Supply	Supply Voltage for LCD and logic (3.3V)
42	VDD	Power Supply	Supply Voltage for LCD and logic (3.3V)
43-51	NC	-	No Connect
52	DEN	-	Data Enable signal (No Connect)
53	GND	Power Supply	Ground
54	GND	Power Supply	Ground

Recommended LCD connector: 0.5mm pitch 54-Conductor FFC. Molex p/n: 51296-5494

Capacitive Touch Panel:

Pin No.	Symbol	External Connection	Function Description
1	V _{DD}	Power Supply	Supply voltage for Logic (3.3V)
2	V _{SS}	Power Supply	Ground
3	SCL	MPU	Serial I2C Clock (Requires 4.7kΩ pull-up resistor)
4	SDA	MPU	Serial I2C Data (Requires 4.7kΩ pull-up resistor)
5	/INT	MPU	Interrupt signal from touch panel module to host
6	/RESET	MPU	Active LOW Reset signal

Recommended connector: 6pin, 1.0mm pitch, FFC connector. Molex P/N 52271-0679



RGB Interface Mode Selection

The Sitronix ST7272A driver IC is user configurable for DE mode, SYNC mode, or SYNC-DE mode RGB interface.

DE Mode is enabled when HSYNC and VSYNC signals are set to logic-low state, and DE signal is toggled high for valid pixel data. Data is clocked in using DCLK signal. DE mode is recommended to enable the ST7272A driver IC to synchronize the display image on TFT panel without depending on specific horizontal and vertical sync timing from host controller.

SYNC Mode is enabled when the DE signal is set to logic-low state, and HSYNC and VSYNC signals are used to explicitly define the horizontal and vertical sync timing to synchronize the display image on TFT panel. Data is clocked in using DCLK signal. Any change to the HSYNC or VSYNC values may prevent the image from correctly appearing on the display.

SYNC-DE Mode is enabled when HSYNC and VSYNC signals are used to explicitly define the horizontal and vertical sync timing to synchronize the display image on TFT panel. DE signal is used as an additional indicator for transmission of valid pixel data. Data is clocked in using DCLK signal. Any change to the HSYNC or VSYNC values may prevent the image from correctly appearing on the display.

RGB Mode Selection Table	DCLK	HSYNC	VSYNC	DE
SYNC-DE Mode	Input	Input	Input	Input
SYNC Mode	Input	Input	Input	GND
DE Mode	Input	GND	GND	Input

Electrical Characteristics

TFT:

Item	Symbol	Condition	Min.	Typ.	Max.	Unit
Operating Temperature Range	T _{OP}	Absolute Max	-20	-	+70	°C
Storage Temperature Range	T _{ST}	Absolute Max	-30	-	+80	°C
Supply Voltage	V _{DD}	-	3.0	3.3	3.6	V
Supply Current	I _{DD}	V _{DD} = 3.3V	10	20	30	mA
"H" Level input	V _{IH}	-	0.7*V _{DD}	-	V _{DD}	V
"L" Level input	V _{IL}	-	V _{SS}	-	0.3*V _{DD}	V
"H" Level output	V _{OH}	-	V _{DD} -0.4	-	V _{DD}	V
"L" Level output	V _{OL}	-	V _{SS}	-	V _{SS} +0.4	V
Backlight Supply Current	I _{LED}	-	30	40	50	mA
Backlight Supply Voltage	V _{LED}	I _{LED} = 40mA	17.4	18.6	19.8	V
Backlight Lifetime*	-	T _{OP} = 25°C	30,000	50,000	-	Hrs.

*Backlight lifetime is rated as Hours until **half-brightness**, under normal operating conditions. The LED of the backlight is driven by current drain; drive voltage is for reference only. Drive voltage must be selected to ensure backlight current drain is below MAX level stated.

Capacitive Touch Panel:

Item	Symbol	Condition	Min.	Typ.	Max.	Unit
Operating Temperature Range	T _{OP}	Absolute Max	-20	-	+70	°C
Storage Temperature Range	T _{ST}	Absolute Max	-30	-	+80	°C
Supply Voltage	V _{DD}	-	2.7	3.0	3.3	V
Supply Current – Operating	I _{DD}	V _{DD} = 3.3V	12	13	14.5	mA
Supply Current – Sleep Mode	I _{DD}	T _{OP} = 25°C	-	42	-	uA
"H" Level Input	V _{IH}	-	0.7 * V _{DD}	-	V _{DD}	V
"L" Level Input	V _{IL}	-	V _{SS}	-	0.3 * V _{DD}	V
"H" Level Output	V _{OH}	-	0.7 * V _{DD}	-	V _{DD}	V
"L" Level Output	V _{OL}	-	V _{SS}	-	0.3*V _{DD}	V

Optical Characteristics:

Item	Symbol	Condition	Min.	Typ.	Max.	Unit	
Optimal Viewing Angles	Top	CR ≥ 10	70	80	-	°	
	Bottom		70	80	-	°	
	Left		70	80	-	°	
	Right		70	80	-	°	
Contrast Ratio	CR	-	640	800	-	-	
Luminance	L _V	I _{LED} = 40 mA	656	900	-	cd/m ²	
Response Time (Rise + Fall)	T _R + T _F	T _{OP} = 25°C	-	30	40	ms	
Chromaticity	Red	X _R	-	0.582	0.632	0.682	-
		Y _R	-	0.296	0.346	0.396	-
	Green	X _G	-	0.311	0.361	0.411	-
		Y _G	-	0.546	0.596	0.646	-
	Blue	X _B	-	0.093	0.143	0.193	-
		Y _B	-	0.031	0.081	0.131	-
White	X _W	-	0.288	0.318	0.348	-	
	Y _W	-	0.290	0.320	0.350	-	

Capacitive Touch Panel Material Characteristics:

Property	Requirement	Unit
IC	FT5426	-
ITO Glass thickness	0.55	mm
Surface Hardness	≥6	H
Light transmission	82%	-
Operating Humidity	20~90	RH
Storage Humidity	20~90	RH

Driver/Controller Information

TFT:

Built-in ST7272A Source Driver: <https://support.newhavendisplay.com/hc/en-us/articles/4414848247575-ST7272A>

Capacitive Touch Panel:

Built-in FocalTech FT5426 controller: <https://support.newhavendisplay.com/hc/en-us/articles/4414392845079-FT5x26>



Capacitive Touch Panel Registers

Register No.	Access	Register Name	Bits	Value	Description
01h	RO	Gesture ID	[7:0]	1Ch	Swipe Up
				14h	Swipe Down
				10h	Swipe Left
				18h	Swipe Right
				48h	Zoom In
				49h	Zoom Out
				00	No gesture
02h	RO	Touch Points	[7:0]	0-Ah	0: No touch detected A: 10 touch points detected
03h	RO	TOUCH1_Event_Flag	[7:6]	0	Put Down
				1	Put Up
				2	Contact
				3	Reserved
03h	RO	TOUCH1_XH	[3:0]	0-1	Upper 4 bits of X touch coordinate
04h	RO	TOUCH1_XL	[7:0]	00 – FFh	Lower 8 bits of X touch coordinate
05h	RO	TOUCH1_YH	[3:0]	0-1	Upper 4 bits of Y touch coordinate
06h	RO	TOUCH1_YL	[7:0]	00 – FFh	Lower 8 bits of Y touch coordinate
07h	RO	TOUCH1_Weight	[7:0]		Touch Weight
08h	RO	TOUCH1_Misc	[3:0]	00-0Fh	Touch Area
09h	RO	TOUCH2_Event_Flag	[7:6]	0	Put Down
				1	Put Up
				2	Contact
				3	Reserved
09h	RO	TOUCH1_XH	[3:0]	0-1	Upper 4 bits of X touch coordinate
0Ah	RO	TOUCH2_XL	[7:0]	00 – FFh	Lower 8 bits of X touch coordinate
0Bh	RO	TOUCH2_YH	[3:0]	0-1	Upper 4 bits of Y touch coordinate
0Ch	RO	TOUCH2_YL	[7:0]	00 – FFh	Lower 8 bits of Y touch coordinate
0Dh	RO	TOUCH2_Weight	[7:0]		Touch Weight
0Eh	RO	TOUCH2_Misc	[3:0]	00-0Fh	Touch Area
0Fh	RO	TOUCH3_Event_Flag	[7:6]	0	Put Down
				1	Put Up
				2	Contact
				3	Reserved
0Fh	RO	TOUCH3_XH	[3:0]	0-1	Upper 4 bits of X touch coordinate
10	RO	TOUCH3_XL	[7:0]	00 – FFh	Lower 8 bits of X touch coordinate
11h	RO	TOUCH3_YH	[3:0]	0-1	Upper 4 bits of Y touch coordinate
12h	RO	TOUCH3_YL	[7:0]	00 – FFh	Lower 8 bits of Y touch coordinate
13h	RO	TOUCH3_Weight	[7:0]		Touch Weight
14h	RO	TOUCH3_Misc	[3:0]	00-0Fh	Touch Area
15h	RO	TOUCH4_Event_Flag	[7:6]	0	Put Down
				1	Put Up
				2	Contact
				3	Reserved
15h	RO	TOUCH4_XH	[3:0]	0-1	Upper 4 bits of X touch coordinate
16h	RO	TOUCH4_XL	[7:0]	00 – FFh	Lower 8 bits of X touch coordinate
17h	RO	TOUCH4_YH	[3:0]	0-1	Upper 4 bits of Y touch coordinate
18h	RO	TOUCH4_YL	[7:0]	00 – FFh	Lower 8 bits of Y touch coordinate
1Ah	RO	TOUCH4_Misc	[3:0]	00-0Fh	Touch Area
1Bh	RO	TOUCH5_Event_Flag	[7:6]	0	Put Down
				1	Put Up
				2	Contact
				3	Reserved



Register No.	Access	Register Name	Bits	Value	Description
1Bh	RO	TOUCH5_XH	[3:0]	0 -1	Upper 4 bits of X touch coordinate
1Ch	RO	TOUCH5_XL	[7:0]	00 – FFh	Lower 8 bits of X touch coordinate
1Dh	RO	TOUCH5_YH	[3:0]	0 -1	Upper 4 bits of Y touch coordinate
1Eh	RO	TOUCH5_YL	[7:0]	00 – FFh	Lower 8 bits of Y touch coordinate
1Fh	RO	TOUCH5_Weight	[7:0]		Touch Weight
20	RO	TOUCH5_Misc	[3:0]	00-0Fh	Touch Area
21h	RO	TOUCH6_Event_Flag	[7:6]	0	Put Down
				1	Put Up
				2	Contact
				3	Reserved
21h	RO	TOUCH6_XH	[3:0]	0 -1	Upper 4 bits of X touch coordinate
22h	RO	TOUCH6_XL	[7:0]	00 – FFh	Lower 8 bits of X touch coordinate
23h	RO	TOUCH6_YH	[3:0]	0 -1	Upper 4 bits of Y touch coordinate
24h	RO	TOUCH6_YL	[7:0]	00 – FFh	Lower 8 bits of Y touch coordinate
25h	RO	TOUCH6_Weight	[7:0]		Touch Weight
26h	RO	TOUCH6_Misc	[3:0]	00-0Fh	Touch Area
27h	RO	TOUCH7_Event_Flag	[7:6]	0	Put Down
				1	Put Up
				2	Contact
				3	Reserved
27h	RO	TOUCH7_XH	[3:0]	0 -1	Upper 4 bits of X touch coordinate
28h	RO	TOUCH7_XL	[7:0]	00 – FFh	Lower 8 bits of X touch coordinate
29h	RO	TOUCH7_YH	[3:0]	0 – 1	Upper 4 bits of Y touch coordinate
2Ah	RO	TOUCH7_YL	[7:0]	00 – FFh	Lower 8 bits of Y touch coordinate
2Bh	RO	TOUCH7_Weight	[7:0]		Touch Weight
2Ch	RO	TOUCH7_Misc	[3:0]	00-0Fh	Touch Area
2Dh	RO	TOUCH8_Event_Flag	[7:6]	0	Put Down
				1	Put Up
				2	Contact
				3	Reserved
2Dh	RO	TOUCH8_XH	[3:0]	0 – 1	Upper 4 bits of X touch coordinate
2Eh	RO	TOUCH8_XL	[7:0]	00 – FFh	Lower 8 bits of X touch coordinate
2Fh	RO	TOUCH8_YH	[3:0]	0 – 1	Upper 4 bits of Y touch coordinate
30	RO	TOUCH8_YL	[7:0]	00 – FFh	Lower 8 bits of Y touch coordinate
31h	RO	TOUCH8_Weight	[7:0]		Touch Weight
32h	RO	TOUCH8_Misc	[3:0]	00-0Fh	Touch Area
33h	RO	TOUCH9_Event_Flag	[7:6]	0	Put Down
				1	Put Up
				2	Contact
				3	Reserved
33h	RO	TOUCH9_XH	[3:0]	0 – 1	Upper 4 bits of X touch coordinate
34h	RO	TOUCH9_XL	[7:0]	00 – FFh	Lower 8 bits of X touch coordinate
35h	RO	TOUCH9_YH	[3:0]	0 – 1	Upper 4 bits of Y touch coordinate
36h	RO	TOUCH9_YL	[7:0]	00 – FFh	Lower 8 bits of Y touch coordinate
37h	RO	TOUCH9_Weight	[7:0]		Touch Weight
38h	RO	TOUCH9_Misc	[3:0]	00 – 0Fh	Touch Area
39h	RO	TOUCH10_Event_Flag	[7:6]	0	Put Down
				1	Put Up
				2	Contact
				3	Reserved
39h	RO	TOUCH10_XH	[3:0]	0 – 1	Upper 4 bits of X touch coordinate
3Ah	RO	TOUCH10_XL	[7:0]	00 – FFh	Lower 8 bits of X touch coordinate
3Bh	RO	TOUCH10_YH	[3:0]	0 – 1	Upper 4 bits of Y touch coordinate
3Ch	RO	TOUCH10_YL	[7:0]	00 - FFh	Lower 8 bits of Y touch coordinate



Register No.	Access	Register Name	Bits	Value	Description
3Dh	RO	TOUCH10_Weight	[7:0]	00-FFh	Touch Weight
3Eh	RO	TOUCH10_Misc	[3:0]	00-0Fh	Touch Area
A1h	RO	ID_G_LIB_VERSION_H	[7:0]	00-FFh	App library version high-byte Default: 0
A2h	RO	ID_G_LIB_VERSION_L	[7:0]	00-FFh	App library version low-byte Default: 2h
A3h	RO	ID_G_CHIPER_HIGH	[7:0]	00-FFh	Chip Vendor ID Default: 0x54
A6h	RO	ID_G_FIRMID	[7:0]	00-FFh	Firmware ID Number Default: 2
A8h	RO	ID_G_VENODRID	[7:0]	00-FFh	CTPM Vendor's Chip ID Default: 79h

AC Characteristics

System Operation AC Characteristics

Item	Symbol	Min.	Typ.	Max.	Unit	Conditions
VDD Power Source Slew Time	TPOR	-	-	20	ms	From 0V to 99% VDD
GRB Pulse Width	tRSTW	10	50	-	us	R=10Kohm, C=1uF
SD Output Stable Time	Tst	-	-	12	us	Output settled within +20mV Loading = 6.8k+28.2pF.
GD Output Rise and Fall Time	Tgst	-	-	6	us	Output settled (5%~95%), Loading = 4.7k+29.8pF

System Bus Timing for 3-Wire SPI Interface

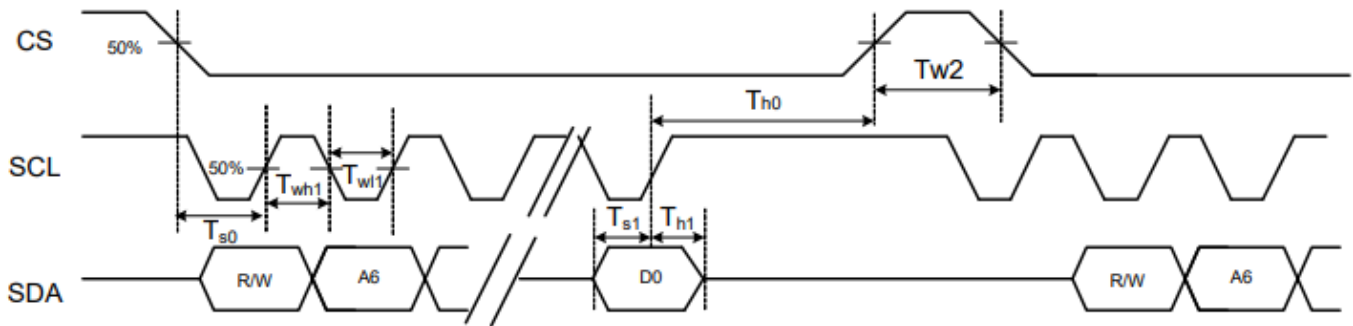

Item	Symbol	Min.	Typ.	Max.	Unit	Conditions
CS Input Setup Time	Ts0	50	-	-	ns	
Serial Data Input Setup Time	Ts1	50	-	-	ns	
CS Input Hold Time	Th0	50	-	-	ns	
Serial Data Input Hold Time	Th1	50	-	-	ns	
SCL Write Pulse High Width	Twh1	50	-	-	ns	
SCL Write Pulse Low Width	Twl1	50	-	-	ns	
SCL Read Pulse High Width	Trh1	300			ns	
SCL Read Pulse Low Width	Trl1	300			ns	
CS Pulse High Width	Tw2	400	-	-	ns	

Timing Characteristics – TFT Display

System Bus Timing for RGB Interface

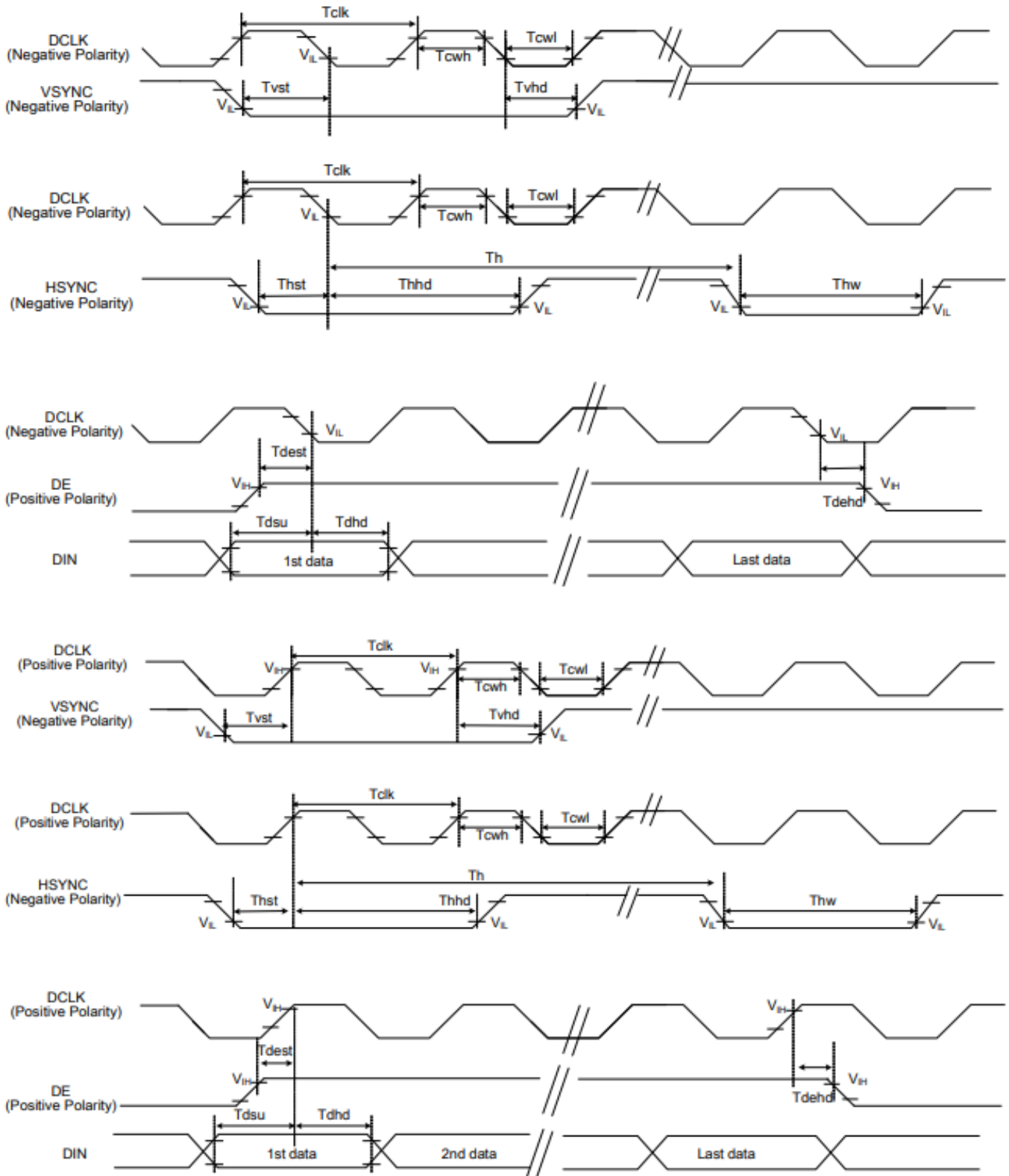

Parallel 24-bit RGB Input Timing (V_{DD} = 3.3V, GND = 0V, T_{OP} = 25°C)

Parallel 24-bit RGB Input Timing Table							
Item	Symbol	Min.	Typ.	Max.	Unit	Note	
DCLK Frequency	Fclk	5	6	8	MHz		
DCLK Period	Tclk	125	167	200	ns		
HSYNC	Period Time	Th	325	371	438	DCLK	
	Display Period	Thdisp	-	320	-	DCLK	
	Back Porch	Thbp	3	43	43	DCLK	SYNC mode back porch control by H_BLANKING[7:0] setting Thbp= H_BLANKING[7:0]
	Front Porch	Thfp	2	8	75	DCLK	
	Pulse Width	Thw	2	4	43	DCLK	
VSYNC	Period Time	Tv	244	260	289	HSYNC	
	Display Period	Tvdisp	-	240	-	HSYNC	
	Back Porch	Tvbp	2	12	12	HSYNC	SYNC mode back porch control by V_BLANKING[7:0] setting Tvbp= V_BLANKING[7:0]
	Front Porch	Tvfp	2	8	37	HSYNC	
	Pulse Width	Tvw	2	4	12	HSYNC	

Note: It is necessary to keep Tvbp =12 and Thbp =43 in sync mode. DE mode is unnecessary to keep it.

System Bus Timing

Item	Symbol	Min.	Typ.	Max.	Unit	Conditions
CLK Pulse Duty	Tclk	40	50	60	%	
HSYNC Width	Thw	2	-	-	DCLK	
VSYNC Setup Time	Tvst	12	-	-	ns	
VSYNC Hold Time	Tvhd	12	-	-	ns	
HSYNC Setup Time	Thst	12	-	-	ns	
HSYNC Hold Time	Thhd	12	-	-	ns	
Data Setup Time	Tdsu	12	-	-	ns	
Data Hold Time	Tdhd	12	-	-	ns	
DE Setup Time	Tdest	12	-	-	ns	
DE Hold Time	Tdehd	12	-	-	ns	

Parallel RGB Sync-DE Mode:

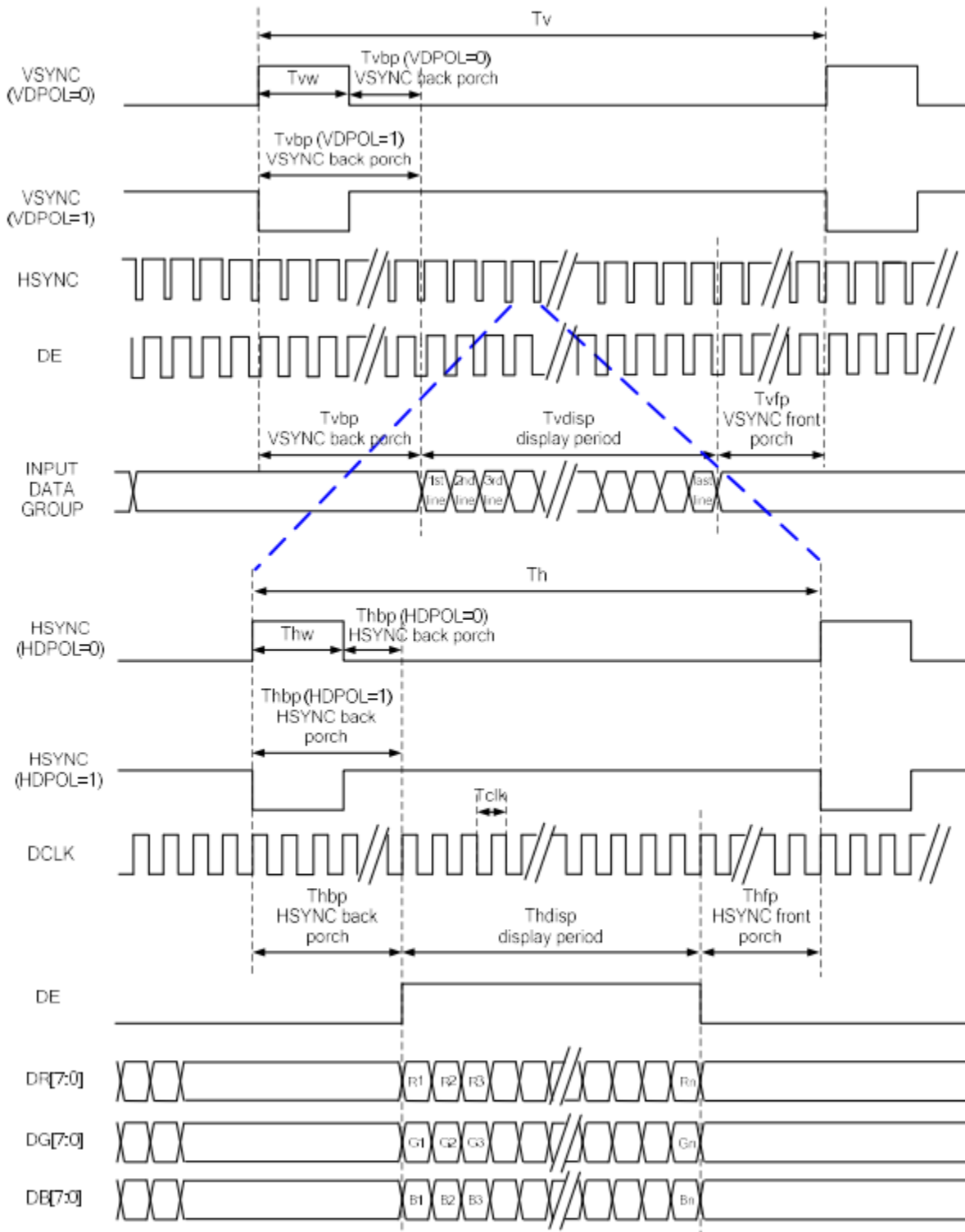

Parallel RGB Sync Mode:

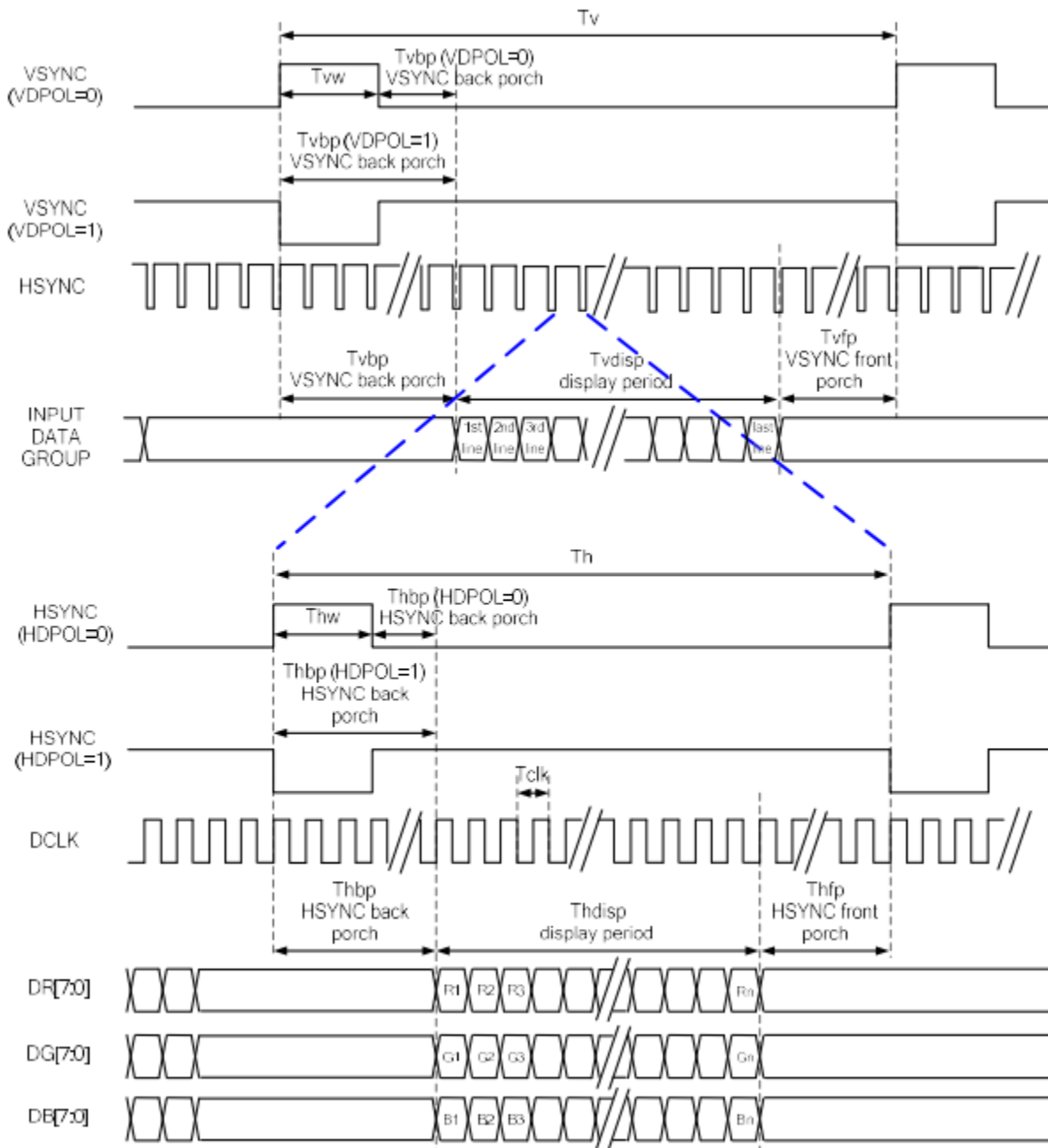

Parallel RGB DE Mode:

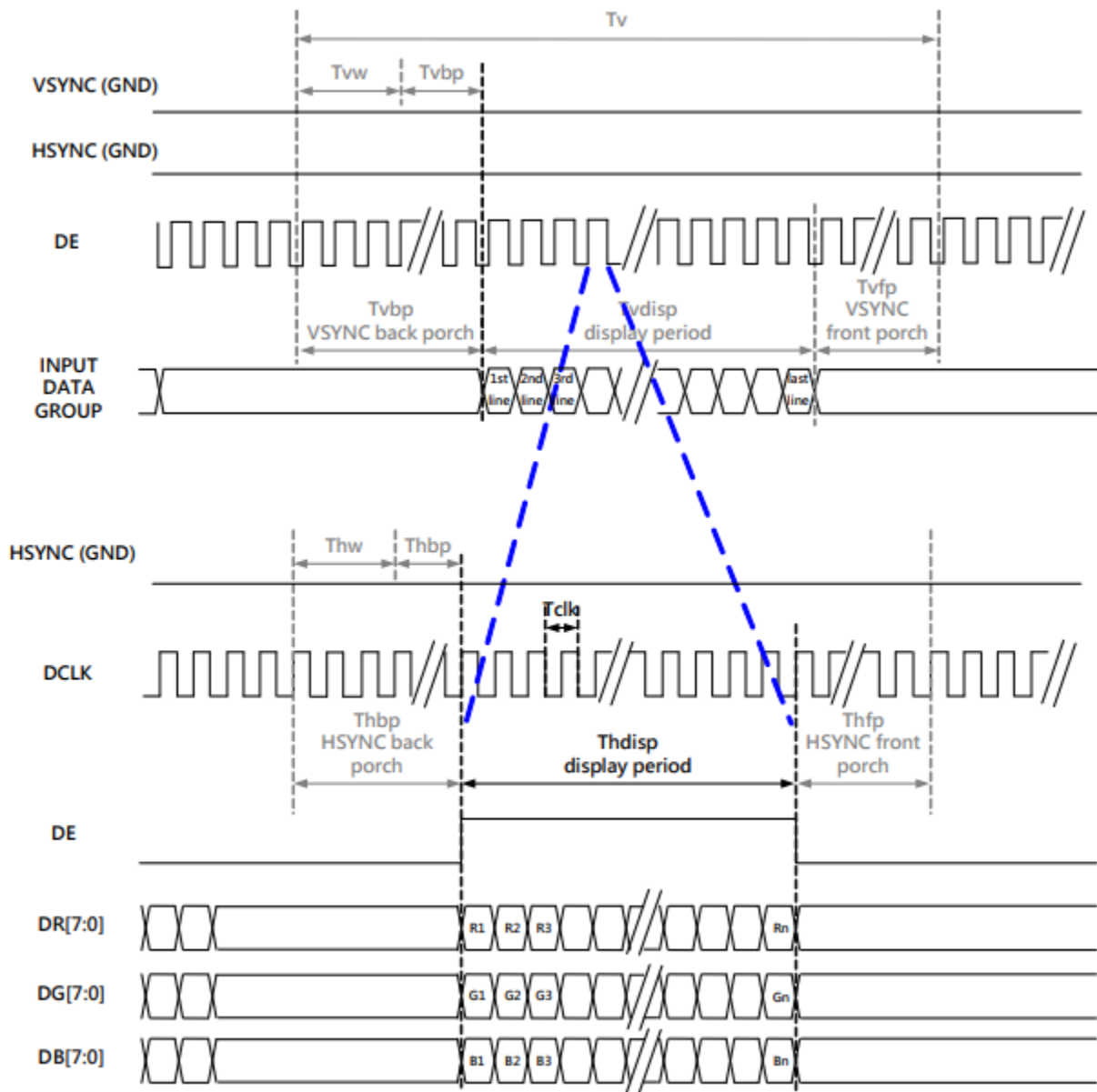

Timing Characteristics – Capacitive Touch Panel

Data Transfer Format

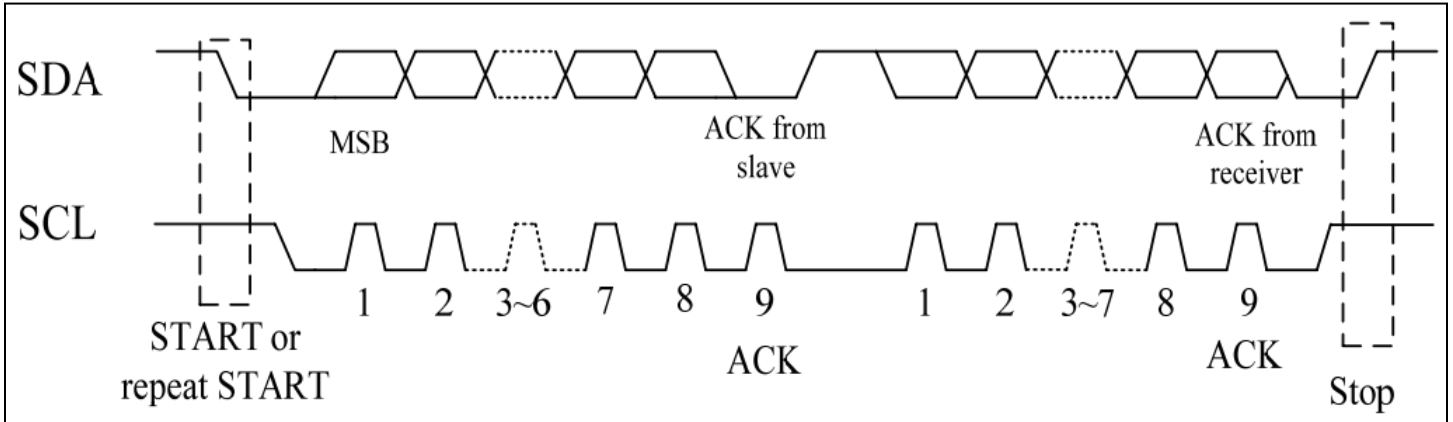

Parameter	Min	Max	Unit
SCL Frequency	0	400	KHz
Bus free time between a STOP & START condition	1.3	-	μs
Hold time Repeated START condition	0.6	-	μs
Data Setup Time	100	-	ns
Setup time for a repeated START condition	0.6	-	μs
Setup time for a STOP condition	0.6	-	μs

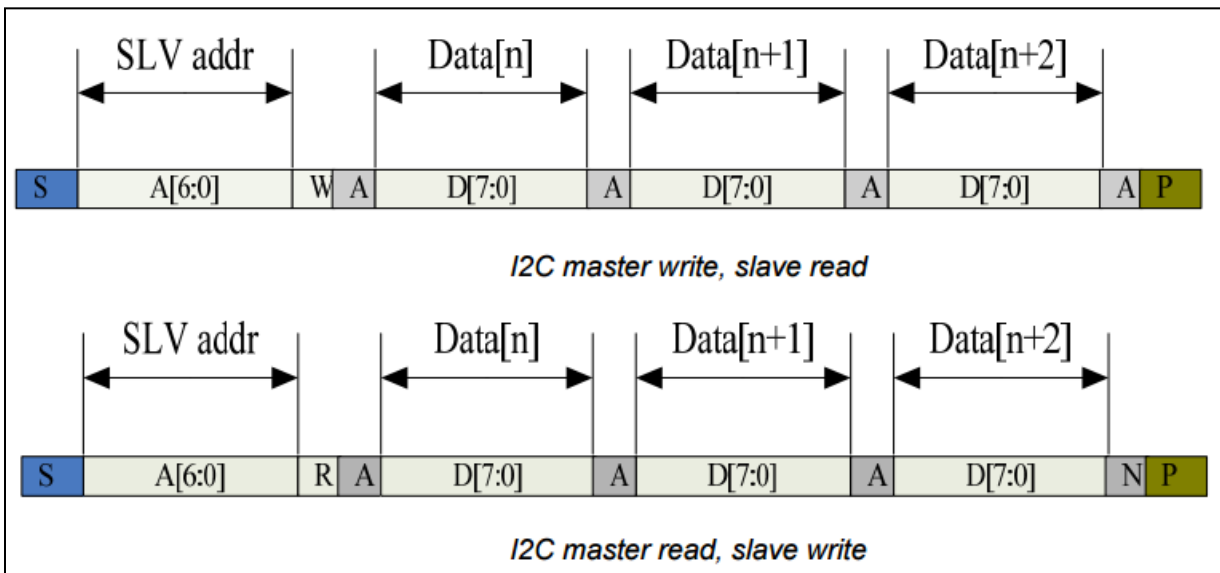

Power ON/Reset Sequence

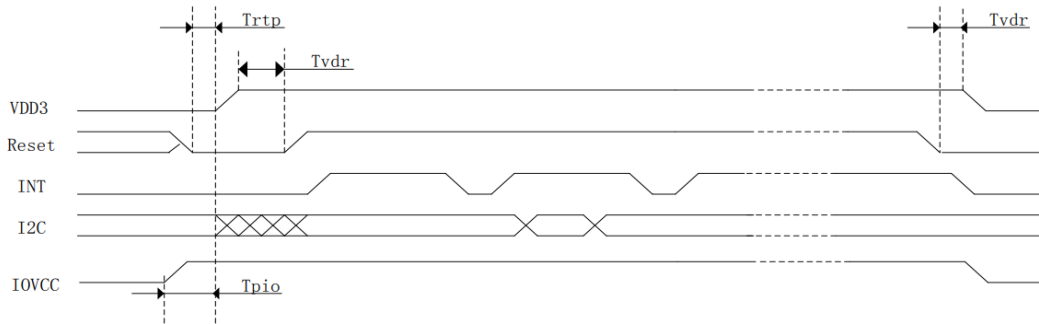
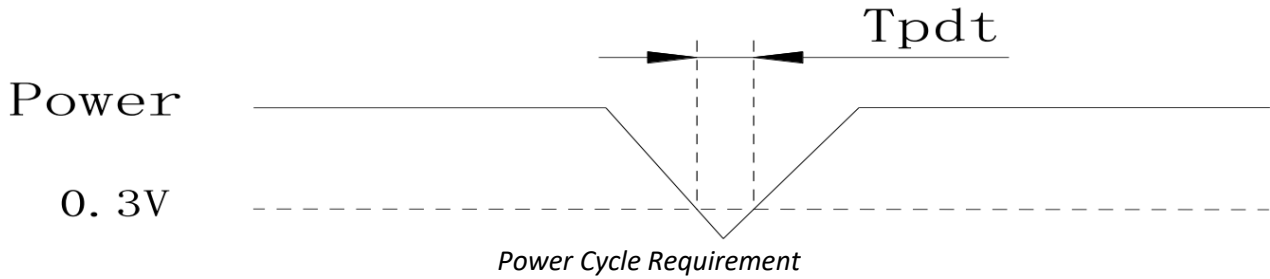
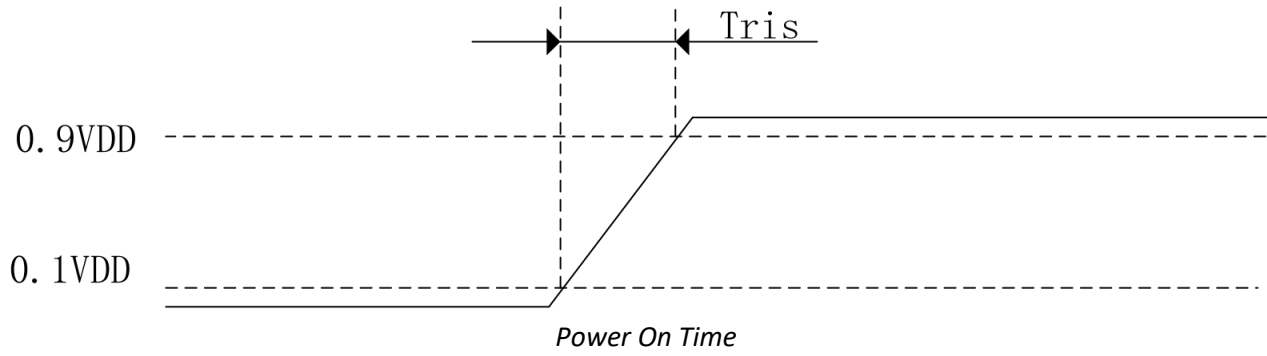

Power ON Sequence

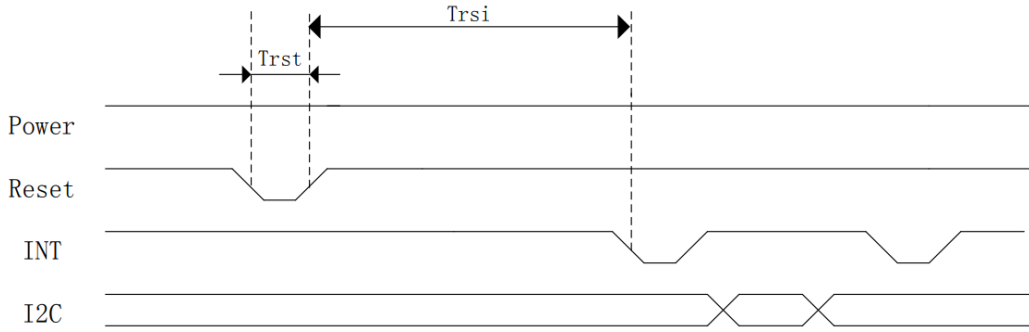

Reset sequence

Parameter	Description	Min	Max	Unit
Tris	Rise time from $0.1V_{DD}$ to $0.9V_{DD}$	-	5	ms
Tpdt	Time of the voltage of supply being below 0.3V	5	-	ms
Trtp	Time of resetting to be low before powering on	100	-	μs
Tpon	Time to start reporting after power on	-	200	ms
Tvdr*	Reset time after applying V_{DD}	1	-	ms
Trsi	Time to start reporting after reset	-	200	ms
Trst*	Reset Time	1	-	ms

*Note: If Reset is tied to V_{DD} data corruption can occur

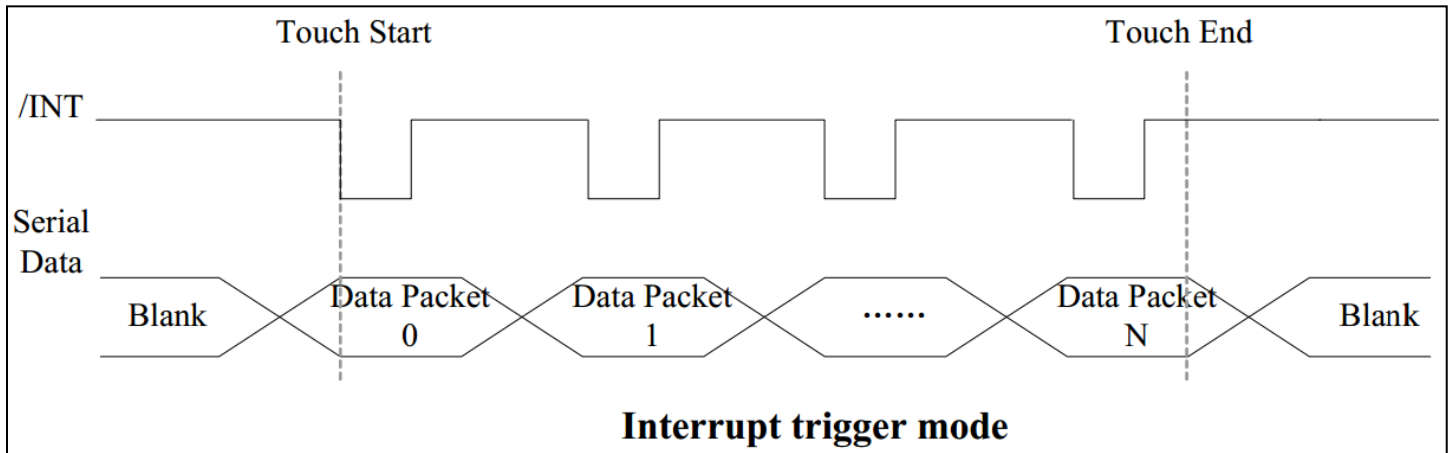

Sample code to read touch data:

```
i2c_start();  
i2c_tx(0x70);           //Slave Address (Write)  
i2c_tx(0x00);           //Start reading address  
i2c_stop();  
  
i2c_start();  
i2c_tx(0x71);           //Slave Address (Read)  
for(i=0x00;i<0x1F;i++)  
{touchdata_buffer[i] = i2c_rx(1);}  
i2c_stop();
```

Sample code to overwrite default register values:

```
i2c_start();  
i2c_tx(0x70);           //Slave Address (Write)  
i2c_tx(0xA4);           //ID_G_Mode  
i2c_tx(0x01);           //Disable interrupt status to host  
i2c_stop();
```

Quality Information

Test Item	Content of Test	Test Condition	Note
High Temperature storage	Endurance test applying the high storage temperature for a long time.	+80°C , 240hrs	2
Low Temperature storage	Endurance test applying the low storage temperature for a long time.	-30°C , 240hrs	1,2
High Temperature Operation	Endurance test applying the electric stress (voltage & current) and the high thermal stress for a long time.	+70°C , 240hrs	2
Low Temperature Operation	Endurance test applying the electric stress (voltage & current) and the low thermal stress for a long time.	-20°C , 240hrs	1,2
High Temperature / Humidity Storage	Endurance test applying the electric stress (voltage & current) and the high thermal with high humidity stress for a long time.	+60°C , 90% RH , 240hrs	1,2
Thermal Shock resistance	Endurance test applying the electric stress (voltage & current) during a cycle of low and high thermal stress.	-30°C,30min -> 25°C,3min -> 80°C,30min = 1 cycle 20 cycles	
Vibration test	Endurance test applying vibration to simulate transportation and use.	10-55Hz , 1.5mm amplitude. 2G Acceleration 30min in each of 3 directions X,Y,Z	3
Static electricity test	Endurance test applying electric static discharge.	Air: ±8kV 150pF/330Ω, 5 Times	
		Contact: ±4kV 150pF/330Ω, 5 Times	

Note 1: No condensation to be observed.

Note 2: Conducted after 4 hours of storage at 25°C, 0%RH.

Note 3: Test performed on product itself, not inside a container.