

MIRRORCLE PLAYZER X-SERIES USER GUIDE

MIRRORCLE TECHNOLOGIES, INC.

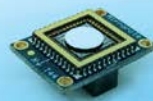

...we move LIGHT ...

Introduction to the Technology

Mirrorcle's **Vector Graphics Laser Projection (VGLP) Architecture** combines a full technology stack of software, electronics, and optical laser beam-steering solutions to enable fully programmable and re-configurable laser projection and display of bright, high-contrast graphic content on a variety of surfaces.

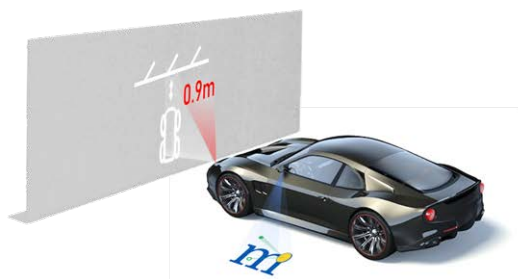

The architecture optimizes the performance of lasers and fast **gimbal-less dual-axis MEMS mirrors** to achieve highest “wall-plug power to visibility” efficiency. A critical feature of the architecture is to utilize lasers of modest optical power at very high duty cycles and to deliver all available illumination to the desired vector graphics and image, and not to spread it over a wide area as in typical pico-projectors or DLP displays.

Playzer is a pocket-sized programmable vector graphic laser projector which consists of a MEMS Mirror-based **Scan Module** with an **embedded Controller**. Playzer may be controlled by **Software Applications** and a **Software API** (Playzer S-Series) or via **Analog Input** or **USB Serial Commands** (Playzer X-Series). It is a compact solution for displaying graphics in a multitude of environments, both outdoor and indoor.

Picoprojector (32 lm)

DLP Projector (100 lm)

VGLP Projector (6 lm)



An indoor, full light comparison of various projector technologies, projecting onto a wall 2m away, shows superior performance of the VGLP white using less power.

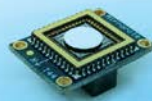

Warning and caution

Danger due to improper use

Any improper use can result in dangerous situations. Therefore, observe the following information:

- Device should be used only in accordance with its intended use.
- All information in these operating instructions must be strictly observed.

Optical radiation: Laser class 3B

It may pose a danger to eyes and skin in the event of incorrect use.

- Do not open the housing. Opening the housing may increase the level of risk.
- Current national regulations regarding laser protection Must be observed.

Hazardous radiation

If any operating or adjusting other than those specified here are used or other methods are employed, this can lead to dangerous exposure to radiation. Damage to the eyes is possible.

- If the product is operated in conjunction with external illumination systems, the risk described here may be exceeded. This must be taken into consideration by the users on a case-by-case basis.
- Do not look into the light source when it is switched on.
- Comply with the latest version of the applicable regulations on photobiological safety of lamps and lamp systems as well as on laser protection.

Electrical voltage

Electrical voltage can cause severe injury or death.

- Work on electrical systems must only be performed by qualified electricians.
- The power supply must be disconnected when attaching and detaching electrical connections.
- The product must only be connected to a voltage supply as set out in the requirements in the operating instructions.
- National and regional regulations must be complied with.
- Safety requirements relating to work on electrical systems must be complied with.

NOTICE

Modifications and conversions to the device may result in unforeseeable dangers.

Interrupting or modifying the device or Mirrorcle software will invalidate any warranty claims against Mirrorcle Technologies, Inc. This applies in particular to opening the housing, even as part of mounting and electrical installation.

The products are sold as component for use in the end products or systems. Therefore, they do not comply with the requirements of FDA 21 CFR, section 1040.10 and 1040.11 for complete laser products.

Buyer of this product assumes all responsibility for the safe operation of the product. Buyer shall provide all signage, warning labels, safety devices, guarding, shielding and other measures as may be necessary and/or appropriate, or which are required by federal, state, or local laws and regulations, for the safe operation of the Product. Buyer shall defend, indemnify and hold Mirrorcle Technologies, Inc. harmless with respect to any property damage and/or personal injury, including death, which is caused by reason of the failure on the part of Buyer, and/or any employee, representative, operator or agent of Buyer, to comply with this term.

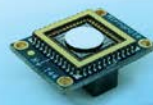

...we move LIGHT ...

Playzer Product Family

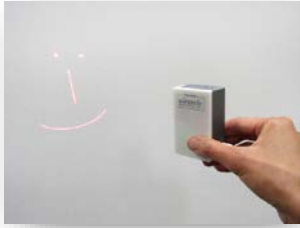

VGLP

Playzer S-Series

Playzer X-Series

User utilizes Mirrorcle's software API for content generation and execution

User implements their own software API to interact with Mirrorcle's VGLP systems

- The Playzer X-Series provides developers, makers, engineers, and students easy access to Playzer technology and its underlying VGLP architecture on the platform of their choice.
 - USB version (PX1-USB) provides open access to the USB communication protocol
 - Analog-input version (PX1-AIN) provides direct access to Scan Module drive signals
- Playzer X-Series, Monochrome
 - PX1-AIN-(R/G/B/V)
 - PX1-USB-(R/G/B/V) (available soon)
- Playzer X-Series, RGB (available soon)
 - PX1-USB-RGB
 - PX1-AIN-RGB
- Playzer S-Series provides complete Playzer Development Kit including Software Development Kits in C++, Matlab, and Labview. This is the most comprehensive development tool that is intended for OEMs and new product developers who intend to utilize Mirrorcle's software API in their product.
 - Playzer S-Series includes a massive library of content generation, execution, and control features on select platforms: Windows & Ubuntu (x86/x86_64 architectures) and Android

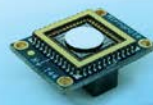

...we move LIGHT ...

Playzer X-Series

Playzer X-Series provides ease-of-access to the Playzer product line and VGLP architecture. The purpose of its simple analog or USB interface is to provide programmable beam steering.

With very low power consumption, devoted mostly to the supply of the laser driver, and with a highly compact mechanical profile, Playzer X-Series is well-suited for the development of many laser pointing applications.

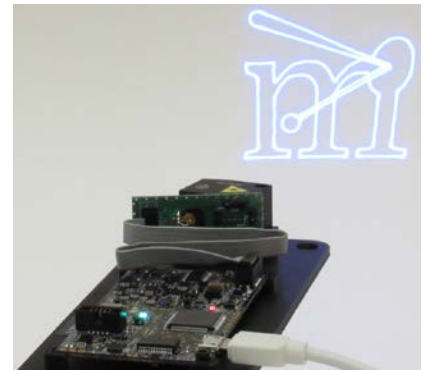

Playzer X-Series provides simplified control of MEMS Mirror and Laser Beam with multiple interface options:

- Analog Input (PlayzerX-AIN)
- USB (PlayzerX-USB) and other options coming soon!

Common specifications of the Playzer X-Series, Monochrome systems:

Bandwidth: dc to ~ 2400 Hz on both axes

Field of Regard (FoR): Approx. $30^\circ \times 30^\circ$

Wavelength: Single laser diode source in (one of these):

- Red (~ 638 nm), target 10mW (8 – 12 mW) CW power
- Green (~ 520 nm), target 10mW (8 – 12 mW) CW power
- Blue (~ 450 nm), target 10mW (8 – 12 mW) CW power
- Violet (~ 405 nm), target 10mW (8 – 12 mW) CW power

Divergence (half angle): < 2.25 mrad

Repeatability: $< 0.005^\circ$ each axis

Available Input Methods: Analog Input, USB

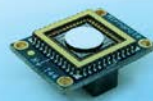

Scan Module EaZy4.0

The Scan Module is an easy to use opto-mechanical assembly of a laser source, beam shaping optics, Mirrorcle MEMS mirror and projection lens to achieve a wide optical Field-of-View beam-steering capability. The modules have the laser diode pins available to be directly driven by the PlayzerX Controller.

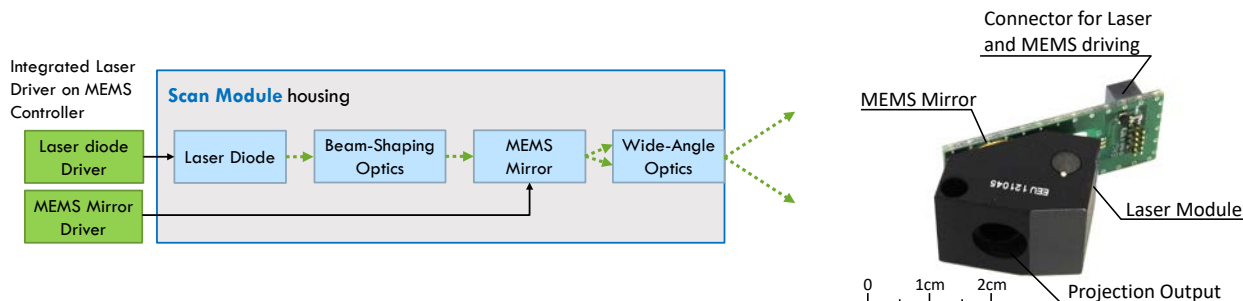

The EaZy4.0 Scan Module projection is defined as follows. Deflection on the X-axis can be defined as Azimuth angle, while deflection on the Y-axis is defined as Elevation angle. Positive input X is a positive Azimuth deflection, and positive input Y is a positive Elevation deflection.

Definitions:

Cartesian coordinate on screen: (x , y)

Spherical coordinate: (Azimuth, Elevation)

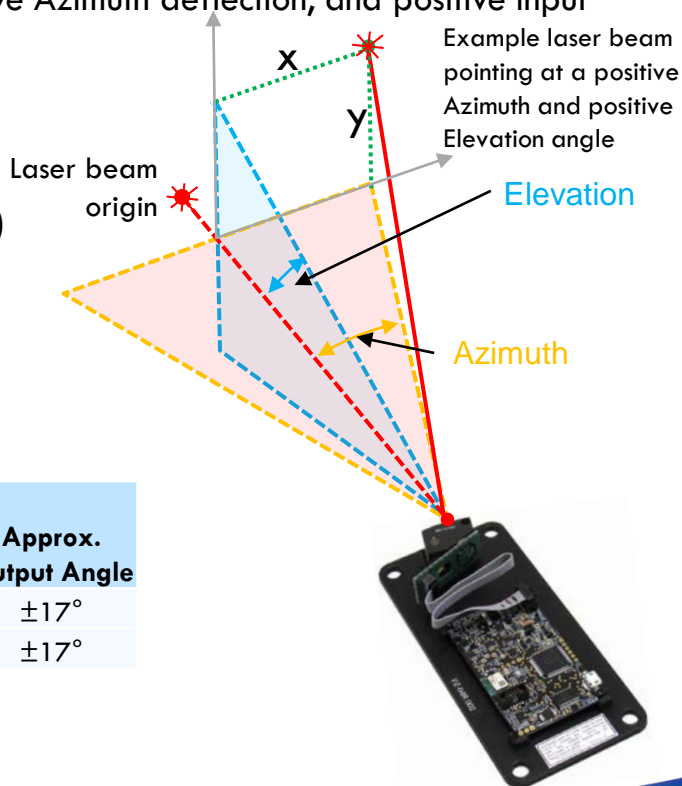

Input	AIN Version Range	USB Version (Coordinates)	Output	Approx. Output Angle
Xin	$\pm 5V$	X (± 1.0)	Azimuth	$\pm 17^\circ$
Yin	$\pm 5V$	Y (± 1.0)	Elevation	$\pm 17^\circ$

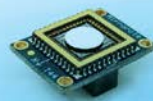

...we move LIGHT ...

Playzer X-Series Scan Module EaZy4.0 – Mechanical Dimensions

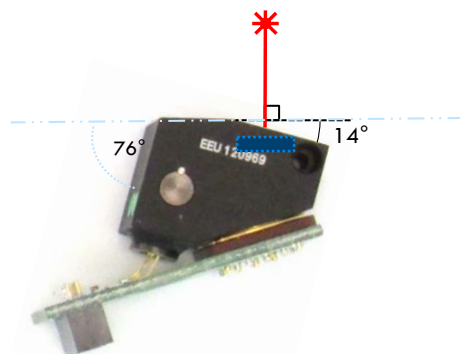
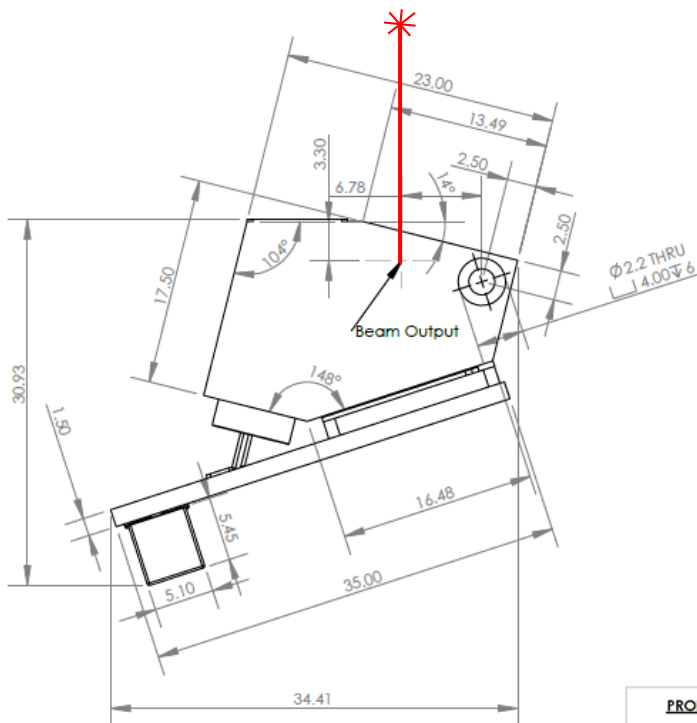
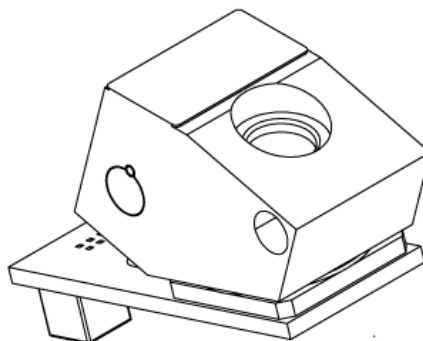
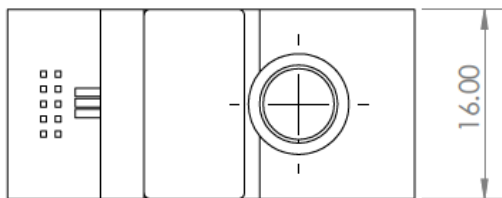

mirrорcle
TECHNOLOGIES, INC.

DIMENSIONS ARE IN MILLIMETERS

TOLERANCES:
3 DECIMAL PLACES: ±0.005
2 DECIMAL PLACES: ±0.1
1 DECIMAL PLACE: ±0.2

MATERIAL:

PROPRIETARY AND CONFIDENTIAL

THE INFORMATION CONTAINED IN THIS DRAWING IS THE SOLE PROPERTY OF MIRRORCLE TECHNOLOGIES, INC. ANY REVIEW, TRANSMISSION, DISCLOSURE, DUPLICATION, DISCUSSION, PUBLISHING, REPRODUCTION IN PART OR AS A WHOLE WITHOUT THE WRITTEN PERMISSION OF MIRRORCLE TECHNOLOGIES, INC IS PROHIBITED. UPDATES AND REVISIONS TO THIS DOCUMENT ARE AT THE SOLE DISCRETION OF MIRRORCLE TECHNOLOGIES, INC.

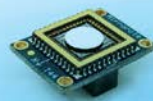

...we move LIGHT ...

Playzer X-Series

Monochrome Playzer Controller – Mechanical Dimensions

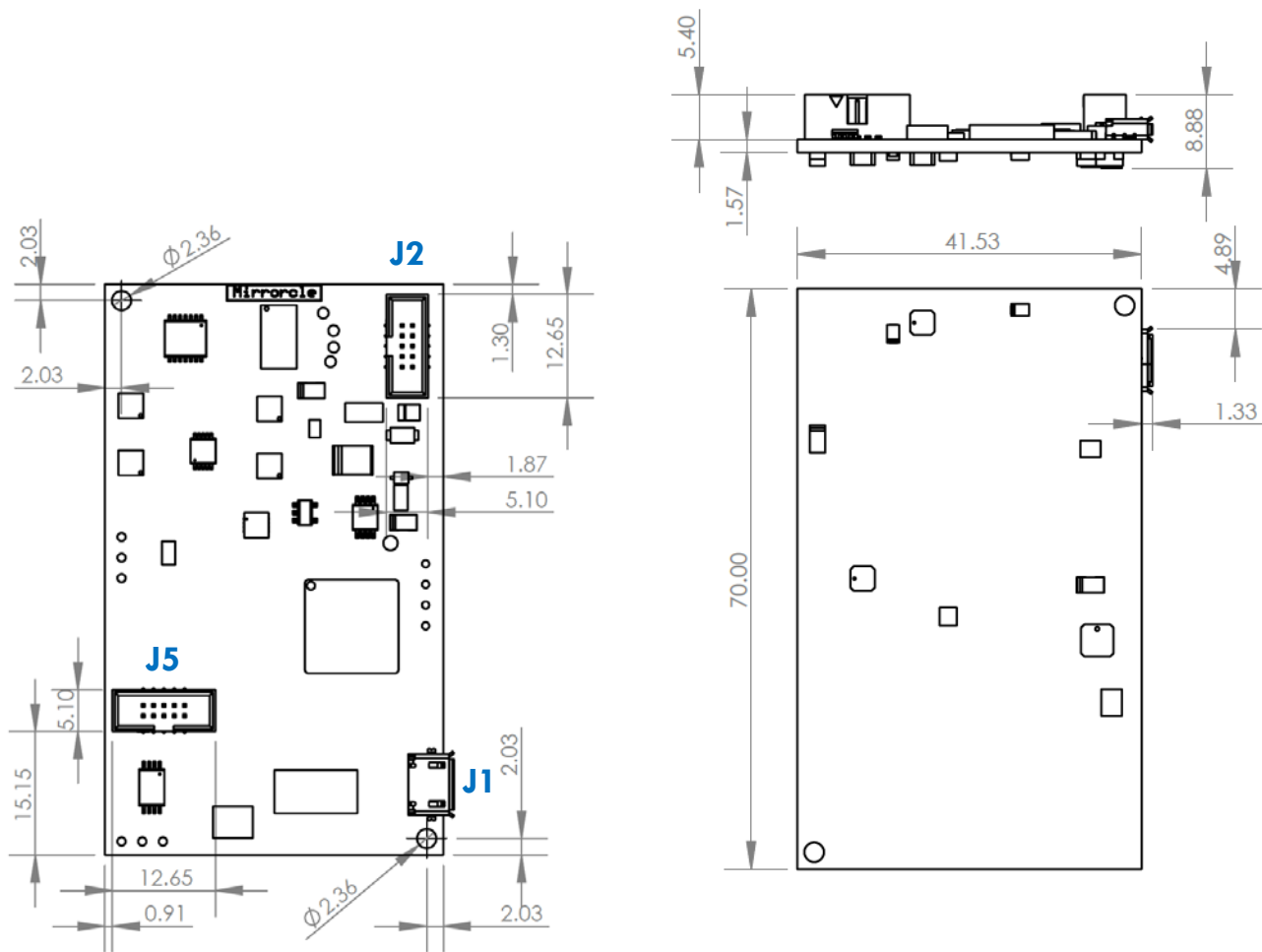

PROPRIETARY AND CONFIDENTIAL

THE INFORMATION CONTAINED IN THIS DRAWING IS THE SOLE PROPERTY OF MIRRORCLE TECHNOLOGIES, INC. ANY REVIEW, TRANSMISSION, DISCLOSURE, DUPLICATION, DISCUSSION, PUBLISHING, REPRODUCTION IN PART OR AS A WHOLE WITHOUT THE WRITTEN PERMISSION OF MIRRORCLE TECHNOLOGIES, INC IS PROHIBITED. UPDATES AND REVISIONS TO THIS DOCUMENT ARE AT THE SOLE DISCRETION OF MIRRORCLE TECHNOLOGIES, INC.



DIMENSIONS ARE IN MILLIMETERS

TOLERANCES:
 3 DECIMAL PLACES: ± 0.005
 2 DECIMAL PLACES: ± 0.1
 1 DECIMAL PLACE: ± 0.2

MATERIAL:

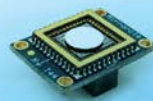

Playzer X-Series – Analog Input

The Analog Input variant of the Playzer X, PlayzerX-AIN allows users to interface via three channels of analog signals, allowing control of laser beam direction (X,Y or azimuth and elevation) and laser beam intensity. **Use of the PlayzerX-AIN requires user's own hardware such as e.g.: data acquisition card (NIDAQ or similar), FPGA/MCU based embedded systems, or bench-top lab equipment.** This Playzer system cannot be directly controlled via a software interface as it takes voltages as inputs.

Compatible third-party vector graphics laser show controllers:

- [Moncha Lite](#)
- [Pangolin FB3QS](#)

Contents

- A. BRK-PX1A Breakout PCBA
- B. Monochrome Playzer Controller
- C. 2x 15cm 10-pin ribbon cables
- D. USB drive with documentation
- E. Scan Module
- F. 3D Printed Cradle mount
- G. USB Micro cable (power)

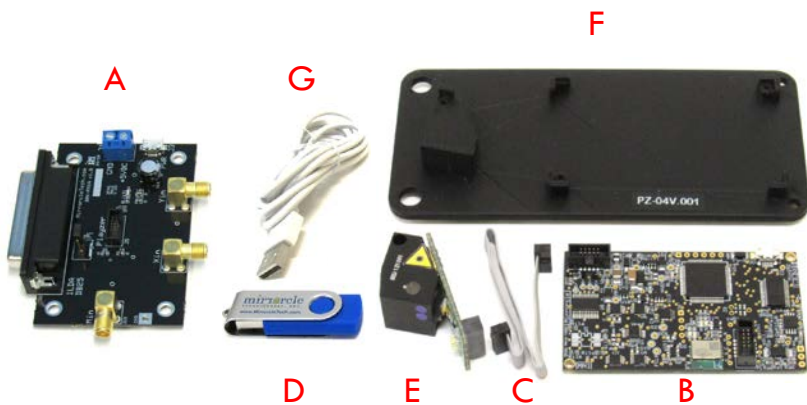

Specifications of the PlayzerX-AIN

Description	Key	Value
X analog voltage in	Xin	-5V to +5V
Y analog voltage in	Yin	-5V to +5V
M analog voltage in	Min	0V to 5V
Power Supply	Vdd	+5VDC
Current Supply	Idd	< 300 mA



PlayzerX-AIN next to a US quarter coin.

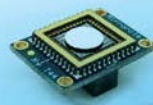

Playzer X-Series – Analog Input

Absolute Maximums

Voltage at Xin/Yin	-6V to +6V
Voltage at Min	-0.5V to +6V
Voltage at Power Supply	4.9V - 5.2V
Temperature	0°C to +85°C



The devices are sensitive to electrostatic discharge. Always ensure adequate grounding when handling the packages. A wrist grounding strap with a 10MΩ series resistance is recommended.

Breakout Connections

Name	Connector ID	Connector Type	Description
Xin	JS1	SMA R/A Female	X voltage input, commands azimuth scan angle of Scan Module
Yin	JS2	SMA R/A Female	Y voltage input, commands elevation scan angle of Scan Module
Min	JS3	SMA R/A Female	M voltage input, commands laser brightness of Scan Module
ILDA	J2	DB-25 Female	DB25 connector to ILDA controllers such as Pangolin FB3QS, Moncha Lite, etc.
Vdd	J1	Wire Terminal	The power to the board (+5V and Gnd) can be provided by wire terminals
USB	J3	USB-Micro	The power to the board (+5V and Gnd) can be provided by USB cable
Host	J5	10 Pin Box Header	The breakout board output connector to power and drive content to Playzer

The breakout board allows for rapid development of the Playzer-X but for application use, the user can connect directly to J5 header on the Playzer-X to power the controller and provide content to drive the Scan Module.

J5-Pin	Name	Description
1	XIN	X-Axis Analog Input Channel
2	YIN	Y-Axis Analog Input Channel
3	VDD	+5V Supply
4	GND	Ground
5-9	NC	No Connection
10	MIN	Laser Modulation Analog Input Channel

Options for Powering PlayzerX-AIN

When using breakout board:

1. Provide +5VDC at USB-Micro (J3, PWR) connector
2. Provide +5VDC at the J1 terminals

When not using breakout board

3. Provide +5VDC at USB-Micro (J1) on embedded Monochrome Playzer Controller
4. Provide +5VDC at J5-Pin 3 on embedded Monochrome Playzer Controller

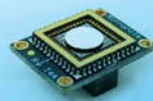

Playzer X-Series – Analog Input Breakout – Schematic

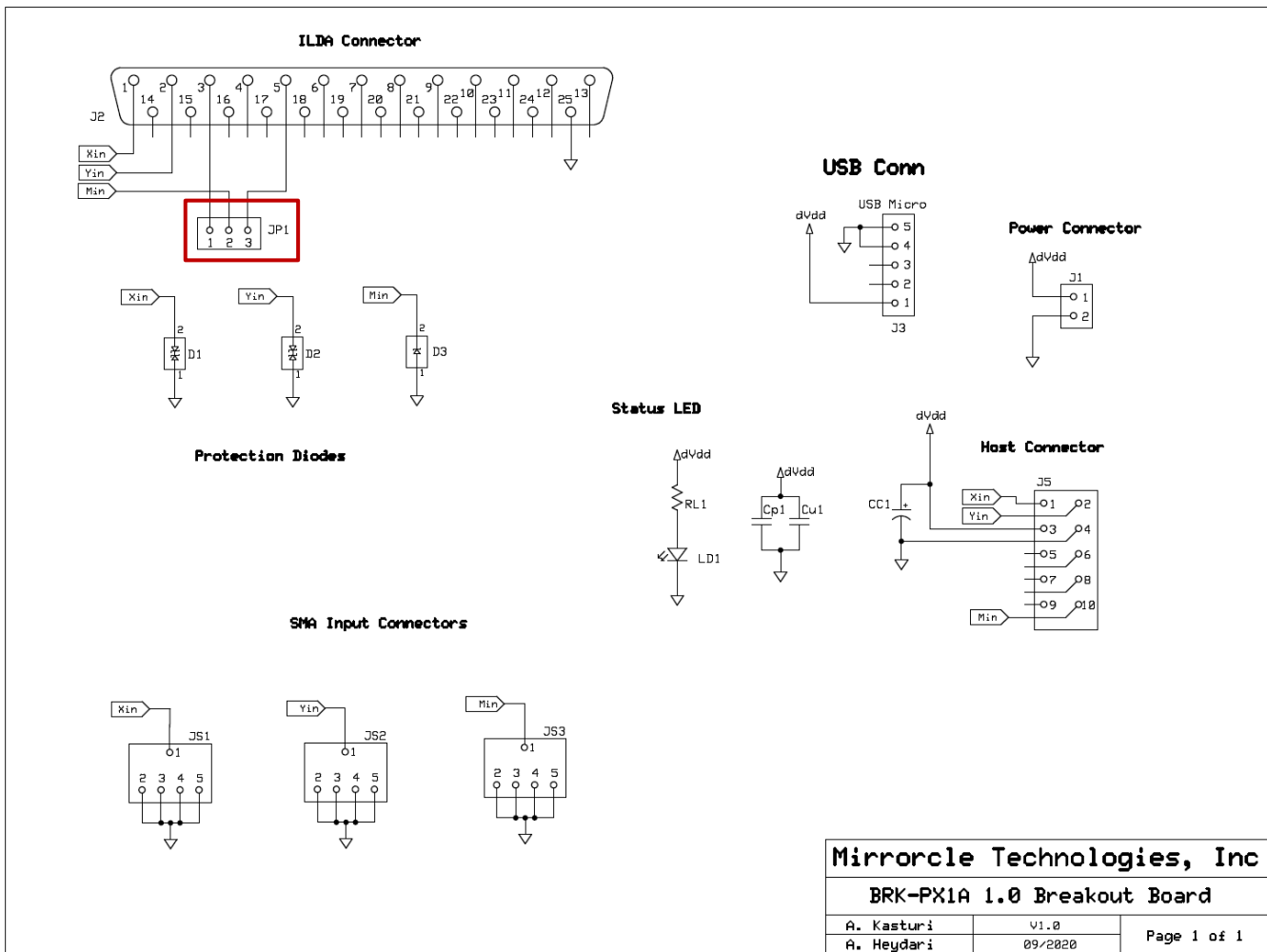

Mirrorcle Technologies, Inc		
BRK-PX1A 1.0 Breakout Board		
A. Kasturi	V1.0	Page 1 of 1
A. Heydari	09/2020	

Pin 1 on JP1 connects to Intensity/Blanking pin on ILDA Connector
 Pin 3 on JP1 connects to Red laser channel analog brightness on ILDA Connector (default population)
 Population of Jumper on JP1 determines the connection of Pin 1 or Pin 3 to Pin 2 for Min

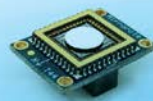

...we move LIGHT ...

Playzer X-Series – Analog Input Breakout (BRK-PX1A) – Mechanical Dimensions

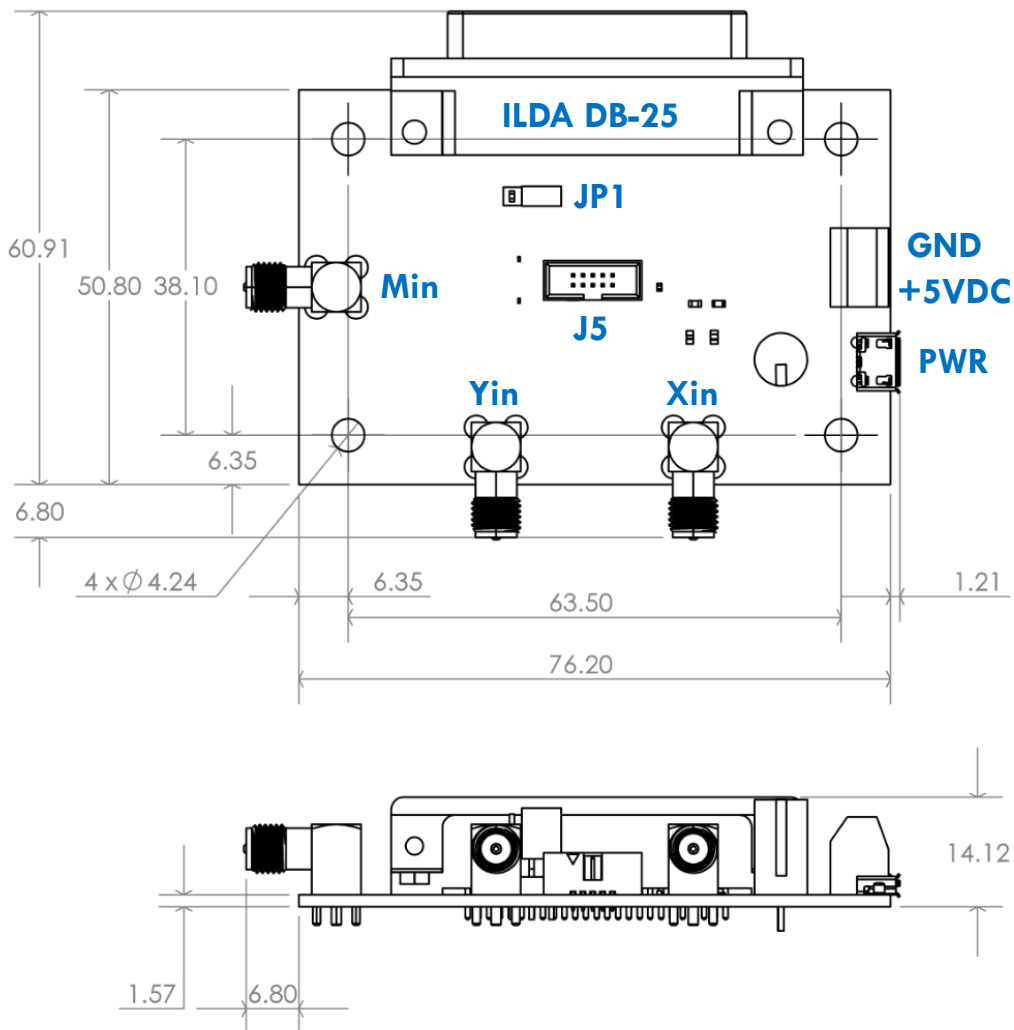

mirrorcle
TECHNOLOGIES, INC.
DIMENSIONS ARE IN MILLIMETERS

TOLERANCES:
3 DECIMAL PLACES: ± 0.005
2 DECIMAL PLACES: ± 0.1
1 DECIMAL PLACE: ± 0.2

MATERIAL:

PROPRIETARY AND CONFIDENTIAL

THE INFORMATION CONTAINED IN THIS DRAWING IS THE SOLE PROPERTY OF MIRRORCLE TECHNOLOGIES, INC. ANY REVIEW, TRANSMISSION, DISCLOSURE, DUPLICATION, DISCUSSION, PUBLISHING, REPRODUCTION IN PART OR AS A WHOLE WITHOUT THE WRITTEN PERMISSION OF MIRRORCLE TECHNOLOGIES, INC. IS PROHIBITED. UPDATES AND REVISIONS TO THIS DOCUMENT ARE AT THE SOLE DISCRETION OF MIRRORCLE TECHNOLOGIES, INC.

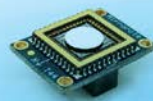

...we move LIGHT ...

Playzer X-Series – Analog Input Example Integrations

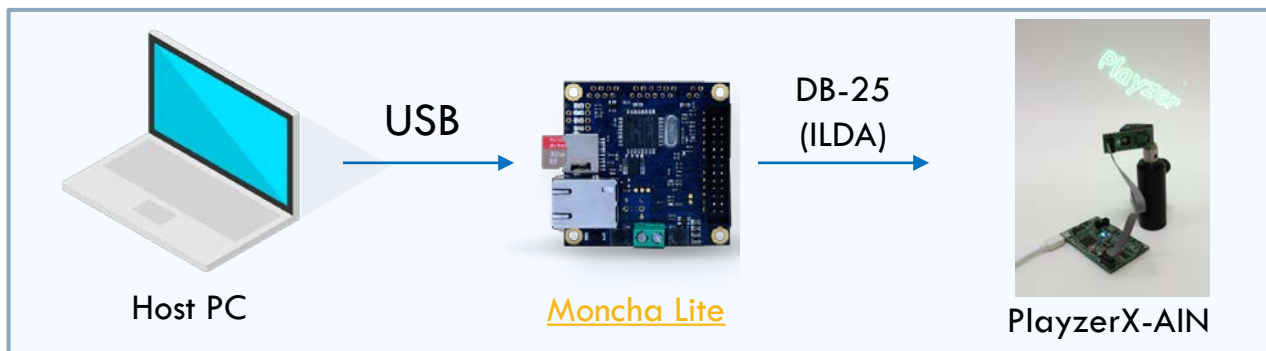

See more details on each setup in next pages

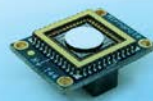

...we move LIGHT ...

Moncha Lite – Example Integration



- Moncha Lite Connections and software setup
 - Download/install from [Moncha](#)
 - Follow the Moncha User Guide for hardware connections and pairing the Moncha Lite to the Moncha software
- PlayzerX-AIN Connections:
 - Power the PlayzerX-AIN via microUSB connection to BRK-PX1A or microUSB connection to the PlayzerX Controller (both examples are shown below)
 - Connect via DB-25 from Moncha Lite to BRK-P1XA breakout board (example below uses male/male gender changer connection)
- Running Moncha with PlayzerX-AIN
 - Run Moncha software, connect to Moncha Lite
 - Choose Effects1.mws (or any show) in the Show Browser
 - Set the scanning rate (20k pps)
 - Enable the laser
 - Start the show



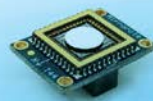

...we move LIGHT ...

Pangolin FB3QS – Example Integration



- FB3QS and Software (QuickShow) setup
 - [Download and install QuickShow software from Pangolin](#)
 - Follow the Pangolin FB3QS setup guide for connections and pairing with QuickShow
- PlayzerX-AIN Connections:
 - Power the PlayzerX-AIN via microUSB connection to BRK-PX1A or microUSB connection to the PlayzerX Controller (both examples are shown below)
 - Connect via DB-25 from FB3QS to BRK-P1XA breakout board (example below uses male/male gender changer connection)
- Running FB3QS with PlayzerX-AIN
 - Connect via DB-25 from FB3QS to PlayzerX-AIN breakout board
 - Run QuickShow
 - In the first-time setup window, choose “Intermediate”, “20k pps”, single laser system, analog laser modulation
 - Choose any content
 - Enable laser output

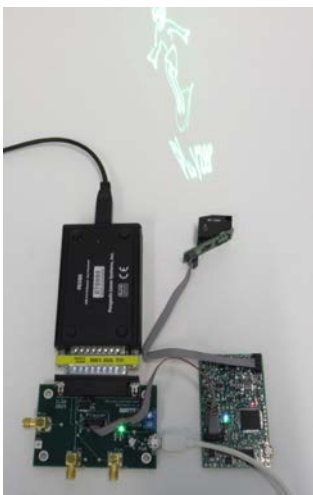

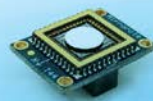

NI-DAQ – Example Integration (Part 1) Connections



- Option 1: Connect the NI-DAQ to the PlayzerX-AIN breakout board according to the scheme specified in the breakout board pinout and your respective NI-DAQ pinout. An example connection guide is show below for USB NI 6341
- Option 2, shown in example below: Connect the NI-DAQ terminals directly to the ribbon cable and input of the PlayzerX Controller, at connector J5. This setup will not utilize BRK-PX1A breakout board.

PlayzerX-AIN Controller			USB-NI 6341	
J5-Pin	Name	Function	Screw Terminal Pin	Function
1	XIN	X-Axis Analog Input	15	AO0
2	YIN	Y-Axis Analog Input	31	AO1
3	VDD	+5V Supply	96	+5VDC
4	GND	Ground	94	DGND
10	MIN	Laser Modulation Analog Input	65	P0.0



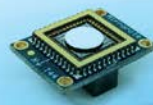

...we move LIGHT ...

NI-DAQ – Example Integration (Part 2)

Test Panels Settings

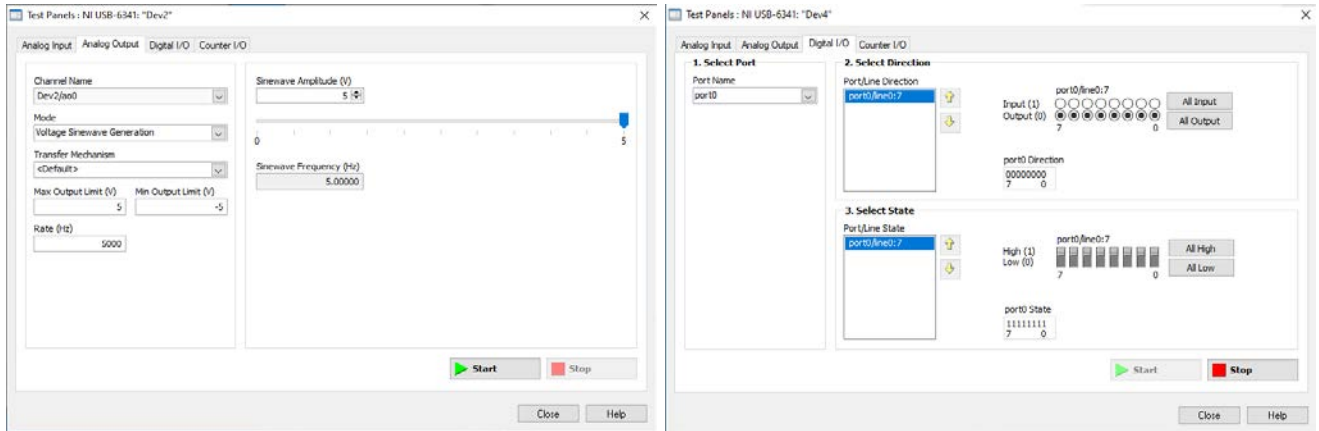

- Open the connected NI-DAQ device in NI-MAX, choose Test Panels
 - In Analog Output tab, set Channel Name to 'ao0', set Mode to 'Voltage Sinewave Generation', set Rate to 5000 Hz, set Max Output Limit (V) to 5, set Min Output Limit (V) to -5. Then, set Sinewave amplitude to 5V
 - Click "Start"
 - In Digital I/O tab, set Port Name to 'port 0', choose 'All Output' for Select Direction, and set the Select State to 'All High'
 - Click "Start"
 - Observe a 5 Hz sinusoidal scan on the X-axis (azimuth scan)
 - In Analog Output tab, click "Stop", change Channel Name to ao1
 - Click "Start"
 - Observe a 5 Hz sinusoidal scan on the Y-axis (elevation scan)

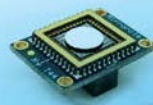

...we move LIGHT ...

Playzer X-Series - USB Input

The micro-USB port on the embedded Monochrome Playzer Controller provides power as well as serial communication via USB.

PlayzerX-USB offers two methods of USB serial communication:

- Binary Mode
- ASCII Mode

ASCII Mode

ASCII mode is more user-intuitive for input into a terminal and using standard floating point numbers rather than binary integer representations of floating point numbers.

Binary Mode

Binary mode can be less intuitive to use, but implements a more efficient use of USB bandwidth by maximizing data encoded in each byte.

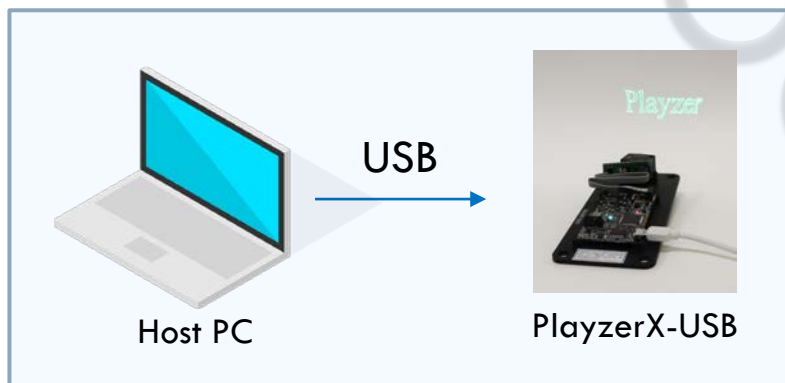

PlayzerX-USB allows direct interface between the Host PC and the PlayzerX interface

Contact sales@mirrortech.com for a formal quotation with most up to date pricing and lead time
Typical lead time is 3-4 Weeks

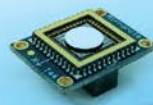

Future of VGLP Displays

CERTIFICATIONS AND QUALIFICATIONS

- Certifications and qualifications are planned in safety, EMC, and automotive categories.
- Mirrorcle is working with multiple foundries in different continents on the path towards serial production and automotive qualification.

RGB PLAYZER PRODUCTION

- For initial prototypes, Mirrorcle has been partnering with vendors for RGB laser modules and assembling final Player Modules in-house.
- Mirrorcle is contracting pilot manufacturing runs of RGB Player modules at qualified CMs.
- Volume production and qualifications will be done with the CM partner.

RGB Player

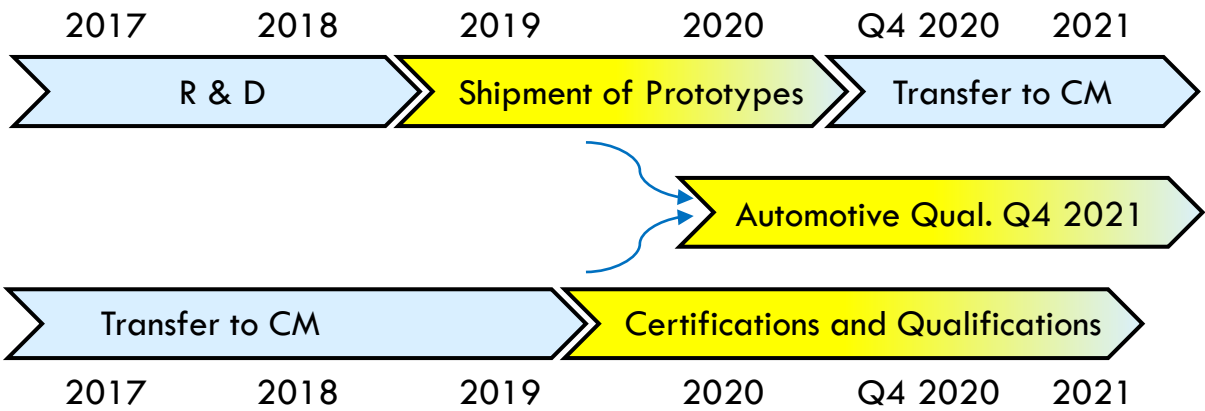

Monochrome Player

Planned Qualifications:

- ISO26262 ASIL B(D), IEC 60825-1
- RoHS, REACH
- CISPR 25