

## Product Description

The **MYTNA1R86RELA2RA** is miniature UltraBK™ called “Ultra Block”, an ultra-thin high efficiency integrated power solution that combines a 6A DC/DC converter with components.

This totally integrated module provides up to 90.0% efficiency in a small and thin 10.5 x 9.0 x 2.1mm LGA package. Murata’s easy-to-use module terminal design allows simple power layout and maximum efficiency by minimizing routing parasitic resistance.

- Wide input voltage 6.0 to 14.4V
- Settable output voltage 0.7 to 1.8V
- Efficiency up to 90.0%  
Up to 87.5% Efficiency with 12VIN/1.8VOUT/6A
- Up to 6A
- Ultra-thin/small 10.5 x 9.0 x 2.1mm LGA package
- Suitable to be placed on the back side of PCB

## Features

- Power good output
- Over-current and Over-temperature protection
- Remote on/off control
- Output voltage sense

## Typical Applications

- PCIe / server applications
- FPGA and DSP
- Datacom / telecom systems
- Distributed bus architectures (DBA)
- Programmable logic and mixed voltage systems

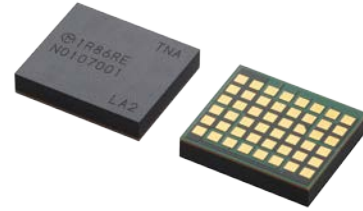

## Efficiency

Ta=25degC VIN=12V, VOUT=1.8V

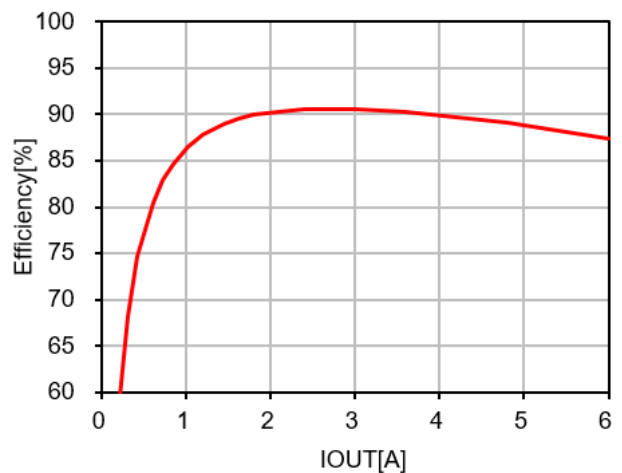

Figure 1. Efficiency Plot

## Simplified Application Circuit

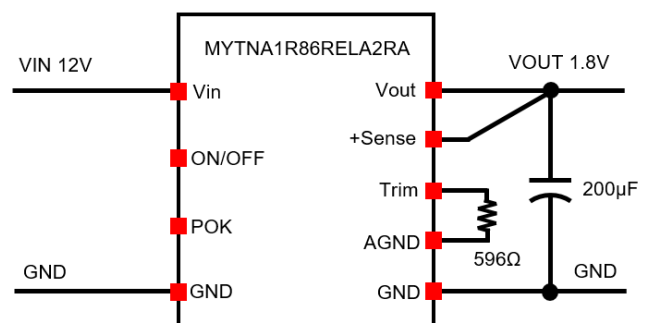

Figure 2. Simplified Circuit Diagram

Product Description .....	1
Features .....	1
Typical Applications.....	1
Efficiency .....	1
Simplified Application Circuit .....	1
Performance Specifications Summary .....	3
Part Number Structure.....	3
Absolute Maximum Ratings.....	4
Recommended Operating Conditions .....	4
Package Thermal Characteristics .....	4
Electrical Characteristics .....	5
Pin Configuration.....	7
Pin Descriptions .....	7
Functional Block Diagram .....	8
Typical Performance Characteristics .....	9
Thermal Deratings (Reference Data) .....	10
Output Voltage Range .....	10
Limitation of Input Voltage Slew rate.....	11
Detailed Description.....	12
Output Voltage Adjustment .....	12
Resistor Trim Equation.....	12
Output Voltage Remote Sense Function .....	12
Remote Enable Function .....	13
Soft Start Function .....	13
Power Good Operation .....	13
Protections .....	13
Over Current Protection and Short Circuit Protection.....	14
Over Temperature Protection .....	14
<b>Soldering Guidelines .....</b>	<b>15</b>
Pb-free Solder Processes .....	15
<b>Dry Pack Information.....</b>	<b>15</b>
<b>Application Performance.....</b>	<b>16</b>
Transient Performance .....	19
Test Circuit .....	19
<b>Component Selection .....</b>	<b>20</b>
Input Fuse .....	20
Input Capacitor.....	20
Output Capacitor .....	20
<b>Packaging Information.....</b>	<b>21</b>
Moisture Sensitivity Level .....	21
Package Drawing.....	21
Recommended Board Land Pattern (Top View).....	21
Top Marking Specification.....	22
<b>Application Circuit Part List (Recommended).....</b>	<b>22</b>
<b>Application Board Example .....</b>	<b>23</b>
<b>Tape and Reel Specification .....</b>	<b>24</b>
<b>Order Codes .....</b>	<b>25</b>

Revision History .....	26
<b>Notices.....</b>	<b>27</b>
Scope .....	27
Limitation of Applications .....	27
Fail-Safe Function.....	28
Product Specification.....	28
Contact form .....	28
<b>Disclaimers .....</b>	<b>29</b>
Patent Statement.....	29
Copyright and Trademark.....	29

## Performance Specifications Summary

Table 1. Performance Specifications Summary

PART NUMBER	OUTPUT						INPUT				Efficiency [%]	ON/OFF	PACKAGE
	V <sub>OUT</sub> [V]	I <sub>OUT</sub> (max.) [A]	Power [W]	R/N (typ.) [% of V <sub>OUT</sub> ]	Regulation		V <sub>IN</sub> (typ.) [V]	Range [V]	I <sub>in</sub> no load [mA]	I <sub>in</sub> full load [A]			
					Line [%]	Load [%]							[mm]
MYTNA1R86RELA2RA	0.7-1.8	6	10.8	1	±1	±1	12	6.0-14.4	25	1.9	87.5	Yes (Positive)	10.5 x 9.0 x 2.1

1.All specifications are at typical line voltage, V<sub>OUT</sub> = 1.8V and full load, +25degC unless otherwise noted. Output capacitors are 100uF x 2 ceramic. Input capacitor is 1000uF electrolysis capacitor. See detailed specifications. Input and Output capacitors are necessary for our test equipment.

2.Use adequate ground plane and copper thickness adjacent to the converter.

## Part Number Structure

Table 2. Part Number Structure

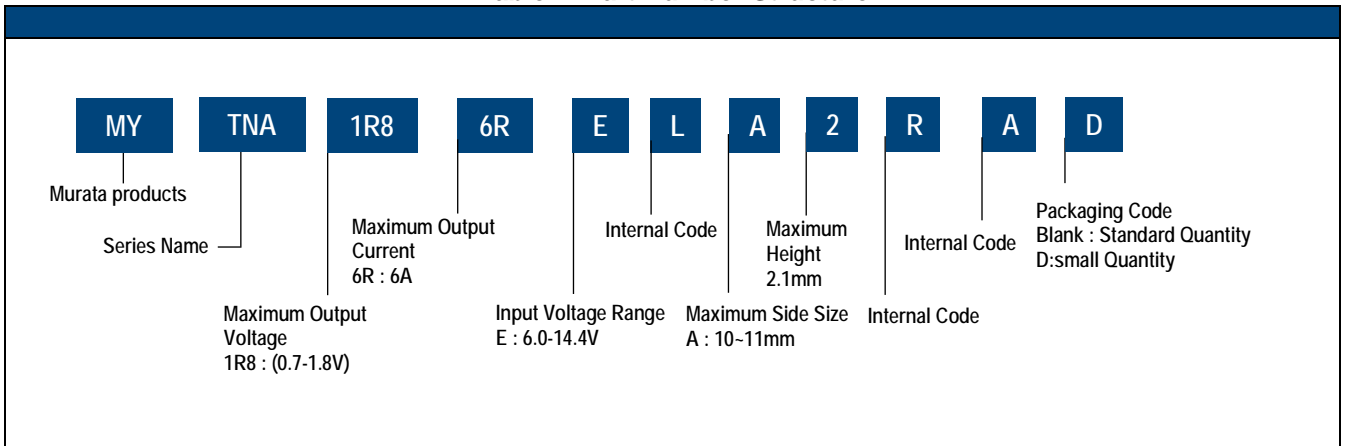

## Absolute Maximum Ratings<sup>(1)(2)</sup>

**Table 3. Absolute Maximum Ratings**

PARAMETER	MIN	MAX	UNITS
VIN, ON/OFF Pin <sup>(3)</sup>	-0.3	16	V
Trim <sup>(4)</sup> , POK Pin	-0.3	5.5	V
Storage Temperature	-40	125	degC
Soldering / Reflow temperature <sup>(5)</sup>	-	260	degC
Maximum Number of Reflows Allowed <sup>(5)</sup>	-	2	
ESD Tolerance, HBM <sup>(6)</sup>	-	1000	V

Notes:

- (1) Stresses beyond those listed under absolute maximum ratings may cause permanent damage to the device. These are stress ratings only. Functional operation of the device at these or any other conditions beyond those indicated in the operational sections of the specification are not implied. Exposure to absolute maximum rating conditions for extended periods may extremely reduce device reliability.
- (2) All voltages are with respect to GND plane.
- (3) Do NOT exceed more than 0.3V from Vin voltage.
- (4) The Trim pin is designed to be connected to GND via a resistor.
- (5) Recommended Reflow profile is written in "Soldering Guidelines".
- (6) Human body model, per the JEDEC standard JS-001-2012.

## Recommended Operating Conditions<sup>(1)</sup>

**Table 4. Recommended Operating Conditions**

PARAMETER	MIN	MAX	UNITS
Input Voltage Range	6.0	14.4	V
Ambient Temperature <sup>(2)</sup>	-40	105	degC
Junction Temperature	-40	120	degC
Load Current	0	6	A

Notes:

- (1) This module should be operated inside the recommended operating conditions. This module has been designed and tested on the assumption that it will be used under the recommended operating conditions. Operating in not recommended condition may reduce reliability of the module.
- (2) See the temperature derating curves in the thermal deratings. However, do not condensate.

## Package Thermal Characteristics<sup>(1)(2)</sup>

**Table 5. Package Thermal Characteristics**

PARAMETER	TYPICAL	UNITS
Θjcb-1 Junction-case-bottom at heat Junction1	10.0	degC/W
Θjcb-2 Junction-case-bottom at heat Junction2	47.3	degC/W
Θjct-1 Junction-case-top at heat Junction1	64.9	degC/W
Θjct-2 Junction-case-top at heat Junction2	53.7	degC/W
Θja Junction-air	19.9	degC/W

Notes:

- (1) Package thermal characteristics and performance are acquired and reported in according to the JEDEC standard JESD51-12. See "Fig.34" below for more information on our measurement conditions.
- (2) Junction thermal resistance is a function not only of the internal parts, but it is also extremely sensitive to the environment which includes, but is not limited to, board thickness, number of layers, copper weight / routes, and air flow. Attention to the board layout is necessary to realize expected thermal performance.

## Electrical Characteristics

$V_{IN}=12V$ ,  $V_{OUT}=1.8V$ ,  $I_{OUT}=6A$ ,  $T_a=+25\text{degC}$ , unless otherwise noted. The Electrical Characteristics table is based on the test circuit in Figure 29.

**Table 6. Electrical Characteristics**

PARAMETER	SYMBOL	CONDITIONS	MIN	TYPICAL	MAX	UNITS
<b>INPUT SUPPLY</b>						
Input Voltage <sup>(1)</sup>	$V_{IN}$		6	12	14.4	V
Input Voltage Start-up Slew rate <sup>(3)</sup>	$V_{IN\_SR}$		Note <sup>(2)</sup>	-	150	V/ms
$V_{IN}$ Under Voltage Lockout Threshold - $V_{IN}$ rising <sup>(3)</sup>	$V_{IN\_UVH}$		-	-	5.45	V
$V_{IN}$ Under Voltage Lockout Threshold - $V_{IN}$ falling <sup>(3)</sup>	$V_{IN\_UVL}$		4.5	-	-	V
$V_{IN}$ Under Voltage Lockout Hysteresis	$V_{IN\_UVHYS}$		-	215	-	mV
$V_{IN}$ Current Supply, Switching	$I_{IN\_SW}$	No Load	-	25	-	mA
$V_{IN}$ Current Supply, Shutdown	$I_{IN\_SD}$	$V_{OUT}=0V$ , ON/OFF=0V	-	160	-	$\mu A$
<b>Remote ON/OFF Control (ON/OFF Pin)</b>						
Threshold High <sup>(3)</sup>	$V_{TH\_ENH}$	Logic ON by pull-up or open of ON/OFF Pin	1.1	-	-	V
Threshold Low <sup>(3)</sup>	$V_{TH\_ENL}$	Logic OFF by pull-down of ON/OFF Pin	-	-	0.4	V
ON/OFF Pin Leakage Current <sup>(3)</sup>	$I_{LK\_EN}$	$V_{IN}=14.4V$ , ON/OFF=0V, From $V_{in}$ to ON/OFF	-	-	200	$\mu A$
<b>CONVERTER</b>						
Efficiency	EFF	$V_{IN}=12.0V$ , $V_{OUT}=1.8V$ , $I_{OUT}=6A$	-	87.5	-	%
		$V_{IN}=12.0V$ , $V_{OUT}=1.2V$ , $I_{OUT}=6A$	-	85.5	-	%
Charge Pump Switching Frequency		Per a phase.	-	500	-	kHz
Buck Converter Switching Frequency		Per a phase.	-	1000	-	kHz
Start-up Time ( $V_{in}$ ON)	$T_{START\_UP}$	$V_{OUT}=5$ to 95% of $V_{OUT}$	-	4	-	ms
Start-up Time (Enable ON)		$V_{OUT}=5$ to 95% of $V_{OUT}$	-	4	-	ms
<b>POWER GOOD (POK Pin)</b>						
POK Sink Current <sup>(3)</sup>		POK=0.4V	4	-	-	mA
POK Pin Leakage Current <sup>(3)</sup>	ILPG	POK=5V, POK=High	-	-	1	$\mu A$
POK & Output Under-Voltage		$V_{OUT}$ falling (fault)	-	90	-	% of $V_{OUT}$
		$V_{OUT}$ rising (good)	-	95	-	
POK & Output Over-Voltage		$V_{OUT}$ rising (fault)	-	110	-	% of $V_{OUT}$
		$V_{OUT}$ falling (good)	-	105	-	
<b>THERMAL SHUTDOWN</b>						
Thermal Shutdown Threshold	$T_{OTPTH}$	Shutdown operating	-	150	-	degC
Thermal Shutdown Hysteresis	$T_{OTPHYS}$		-	20	-	degC
<b>OUTPUT</b>						
Output Voltage <sup>(4)</sup>	$V_{OUT}$	$9.6 \leq V_{IN} \leq 14.4V$	0.7	-	1.8	V
		$7.0 \leq V_{IN} \leq 14.4V$	0.7	-	1.35	V
		$6.0 \leq V_{IN} \leq 14.4V$	0.7	-	1.0	V
Output Voltage Accuracy <sup>(1)(5)</sup>		$6.0 \leq V_{IN} \leq 14.4V$ $0.7 \leq V_{OUT} \leq 1.8V$ <sup>(4)</sup> $0 \leq I_{OUT} \leq 6A$	-3	-	+3	%
Feedback Voltage	$V_{FB}$			0.597		V
Temperature variation <sup>(3)</sup>	$V_{OUT\_TEMP}$	$-40 \leq T_a \leq 105\text{degC}$	-	1	-	%
Total Output Voltage Accuracy <sup>(3)</sup>	$V_{OUT\_ACC}$	$0.7 \leq V_{OUT} \leq 1.8V$ <sup>(4)</sup> $0 \leq I_{OUT} \leq 6A$ $-40 \leq T_a \leq 105\text{degC}$	-3	-	+3	%
Output Current <sup>(1)</sup>	$I_{OUT}$		0	-	6	A
Current Limit Inception			-	11	-	A

$V_{IN}=12V$ ,  $V_{OUT}=1.8V$ ,  $I_{OUT}=6A$ ,  $T_a=+25degC$ , unless otherwise noted. The Electrical Characteristics table is based on the test circuit in Figure 29.

**Table 6. Electrical Characteristics**

PARAMETER	SYMBOL	CONDITIONS	MIN	TYPICAL	MAX	UNITS
Current Limit Method			Hiccup			
Line Regulation <sup>(3)(5)</sup>	$V_{OUT\_LINE}$	$V_{IN}=\text{min. to max.}$	-1	-	+1	%
Load Regulation <sup>(3)(5)</sup>	$V_{OUT\_LOAD}$	$I_{OUT}=\text{min. to max.}$	-1	-	+1	%
Dynamic Load Peak Deviation	$V_{OUT\_DYN}$	$I_{OUT}=50\text{-}100\%$ , $SR=1.0A/\mu s$	-	$\pm 3.0$	-	%
Ripple and Noise <sup>(3)(5)</sup> (20MHz bandwidth)	$V_{RIP}$	$6.0 \leq V_{IN} \leq 14.4V$ $0.7 \leq V_{OUT} \leq 1.8V^{(4)}$ $0 \leq I_{OUT} \leq 6A$	-	-	40	mV pk-pk
		$V_{IN}=12.0V$ $0.7 \leq V_{OUT} \leq 1.8V^{(4)}$ $I_{OUT}=6A$	-	1	-	% of $V_{OUT}$
External Output Capacitance Range <sup>(3)</sup>	$C_{OUT}$		200	-	2000	UF

Notes:

- (1) Min/Max specifications are 100% production tested at  $T_a=25degC$ , unless otherwise noted. Limits over the operating range are guaranteed by design.
- (2) See the section of "Limitation of Input Voltage slew rate".
- (3) Guaranteed by design.
- (4) See the Output Voltage Range of fig.9.
- (5) Only static state.

## Pin Configuration

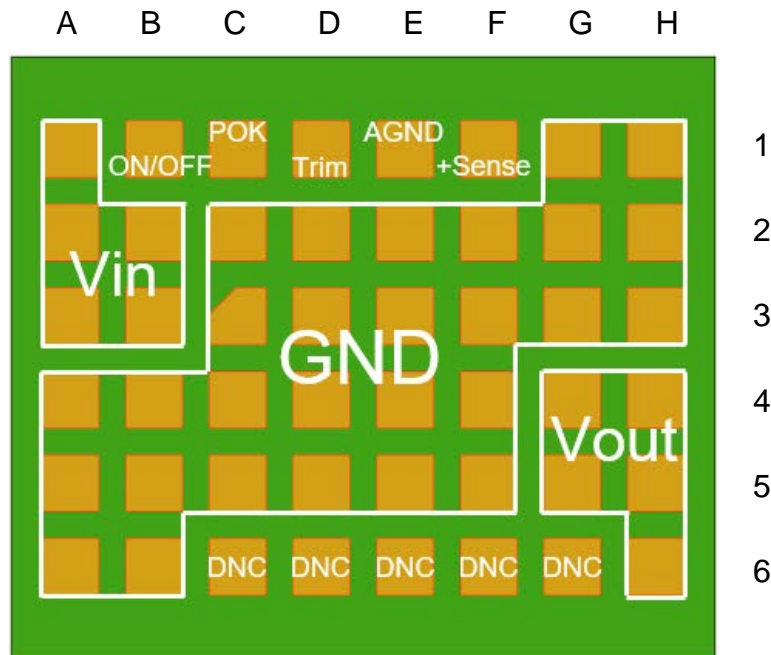

Figure 3. Module Terminal (Top View)

## Pin Descriptions

Table 7. Pin Descriptions

PIN NO.	NAME	DESCRIPTION
A1-3, B2, B3	Vin	Input Voltage pins. Apply input voltage between these pins and GND pins.
A4-6, B4-6, C2-5, D2-5, E2-5, F2-5, G1-3, H1-3	GND	Ground pins. Connect to the GND plane.
B1	ON/OFF	Remote ON/OFF pin. This pin is connected to Vin through the internal resistance.
C1	POK	Power Good pin. The function is operated by internal open-drain FET.
C6, D6, E6, F6, G6	DNC	Do not connect pins. Those pins must be left floating individually.
D1	Trim	Trimming pin. Connect to the resistor to adjust to the target output voltage.
E1	AGND	Analog ground pin. Connect to trimming Resistor.
F1	+Sense	Output Voltage Sensing pin. Connect to an output near the load to improve load regulation. This pin must be connected to output near the load, or at the module pins.
G4-5, H4-6	Vout	Output pins. Connect the output load between these pins and Ground pins. Place external bypass capacitors as close as possible to these pins to reduce parasitic inductance.

### Functional Block Diagram

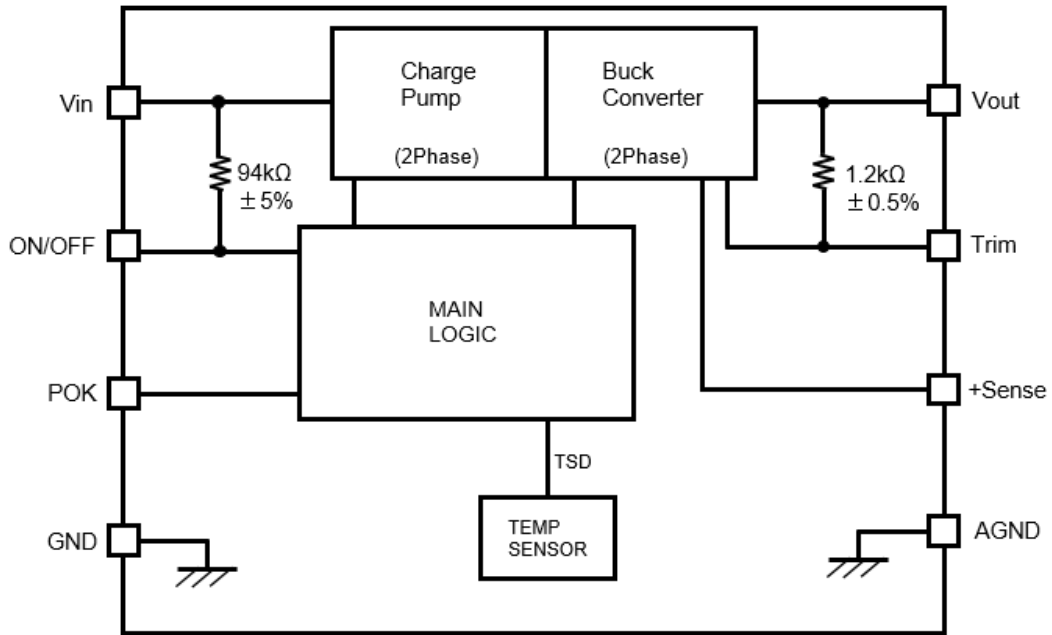

Figure 4. Functional Block Diagram



## Typical Performance Characteristics

( $V_{IN} = 12V$   $T_a = 25\text{degC}$ )

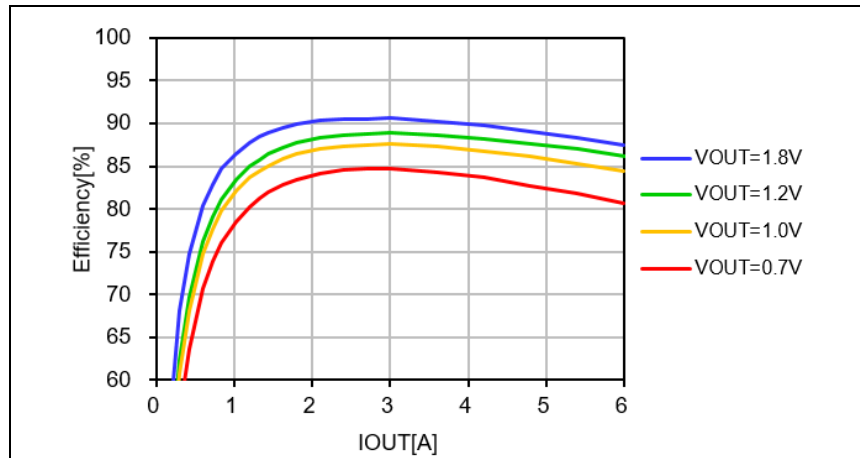
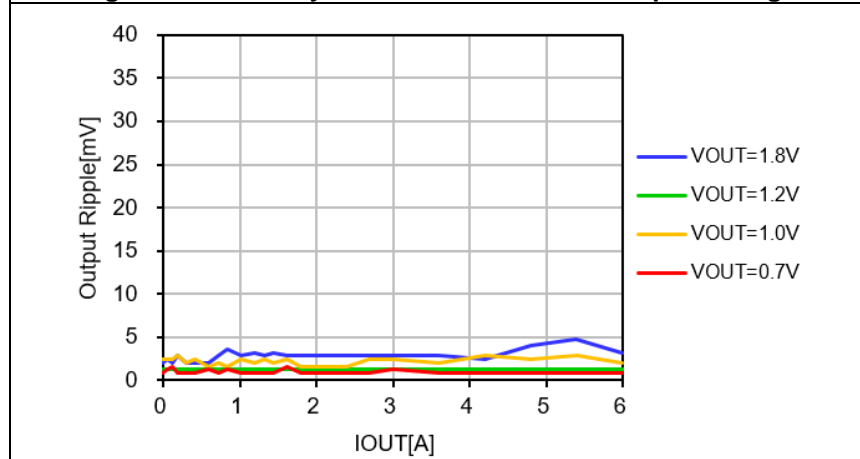

Figure 5. Efficiency vs. Load Current and Output Voltage



( $C_{OUT} = 200\mu F$ , ScopeBW = 20MHz)

Figure 6. Output Ripple vs. Load Current and Output Voltage

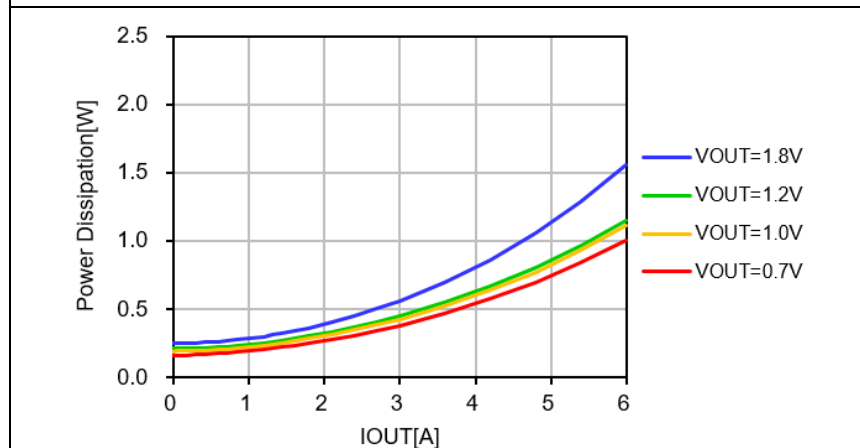
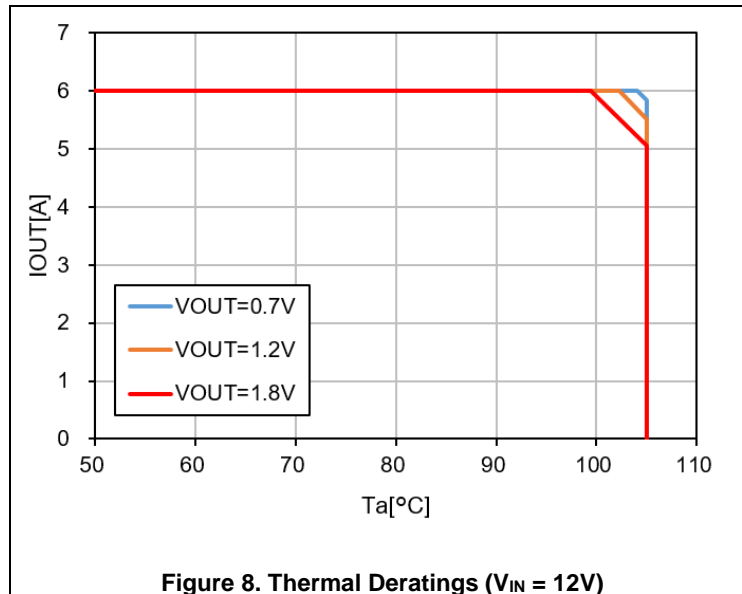

Figure 7. Power Dissipation vs. Load Current and Output Voltage

### Thermal Deratings (Reference Data)



Thermal deratings are evaluated in following condition.

- The product is mounted on 114.5 x 101.5 x 1.6mm (Layer1, 4: 2oz Layer2, 3: 1oz copper) FR-4 board.
- No forced air flow.

Surface temperature of the product: 118.7degC max.

### Output Voltage Range

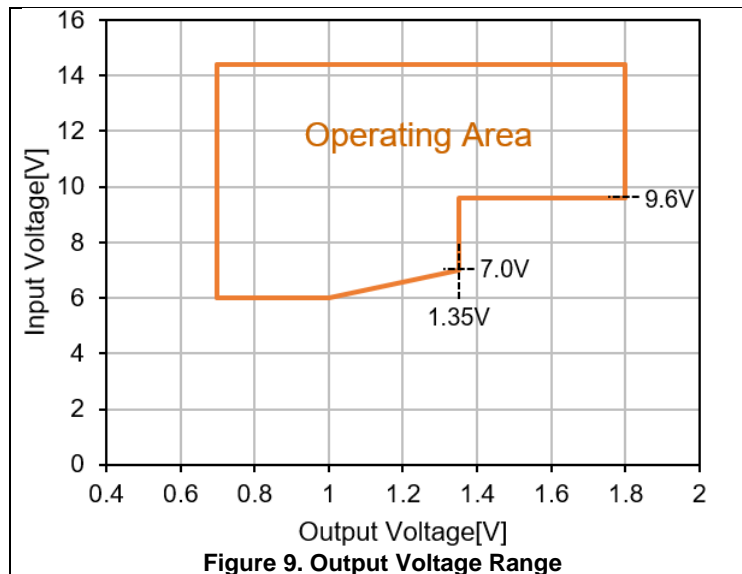

### Limitation of Input Voltage Slew rate

When starting the module with ramping Input Voltage up, the slew rate of the ramping should be managed for the proper operation. If Input Voltage ramping up is too steep, it would cause charge injection to the internal nodes via parasitic. The maximum slew rate of the Input Voltage ramp up when booting the module with Input Voltage is specified on the table 6 "Electronic Characteristics".

Similarly, if the  $V_{IN}$  slew rate is too low compare with  $V_{OUT}$  slew rate, it could prevent expected start-up behavior. To avoid hitting the maximum duty cycle operation, the  $V_{IN}$  slew rate should satisfy the equation of (eq.1). As a reference, estimated value of the slew rate and start-up time for each output voltage is written in the follow table.  $V_{INSR\_L}$  is minimum of input voltage start-up slew rate.

$$V_{INSR\_L} [V/ms] \geq 0.2 \times V_{OUT}[V] - 0.1 \quad (eq.1)$$

**Table 8. Minimum Input Voltage Start-Up Slew Rate and Start-Up Time**

OUTPUT VOLTAGE [V]	CALCULATION EXAMPLE	
	$V_{INSR\_L}$ [V/ms]	VIN RISE TIME [ms] (0V to 12V)
1.8	0.26	46.2
1.2	0.14	85.7
1.0	0.1	120

## Detailed Description

The MYTNA1R86RELA2RA is a two-stage DCDC converter that is composed of a dual-phase charge pump-based DCDC converter and a dual-phase synchronous buck DCDC converter. The output voltage range supported from 0.7 to 1.8V (The output voltage range depend on the input voltage.) with load currents of up to 6A and up to 10.8W delivered to the external load. This module isn't designed for the parallel operation.

### Output Voltage Adjustment

The output voltage may be adjusted over a limited range by connecting an external trim resistor (Rtrim) between the Trim pin and AGND pin. The Rtrim must be a 1/10W (or larger) precision metal film type, ±0.5% accuracy (or better) with low temperature coefficient, ±100 ppm/degC (or better). Mount the resistor close to the converter with very short leads or use a surface mount trim resistor. Also, avoid high noise at the trim pin. However, to prevent instability, you should never connect any capacitors between trim pin and GND pin. And do not connect any additional components between the Trim pin and Vout or between the Trim and Sense pins. Use only the specified connections.

### Resistor Trim Equation

$$R_{trim}[k\Omega] = 0.7164 / (V_{OUT} - 0.597) \quad (eq.2)$$

The equations above are only reference, so please be sure to check the output voltage and adjust Rtrim in user circumstances. To increase or decrease the output voltage, increase or decrease the Rtrim value.

In the table below, the estimated resistance is given at limited condition. Do not exceed the specified limits of the output voltage range restricted by input voltage or the converter's maximum power rating when applying these resistors.

**Table 9. Output Voltage and Rtrim Value**

OUTPUT VOLTAGE [V]	CALCULATED [OHM]	EXAMPLE OF Rtrim [OHM] (E24 RESISTOR VAULE)
0.70	6955.3	6.8k+160
0.80	3529.1	3.3k+220
0.90	2364.4	2.2k+160
1.00	1777.7	1.6k+180
1.10	1424.3	1.3k+120
1.20	1188.1	680+510
1.30	1019.1	510+510
1.35	951.4	820+130
1.40	892.2	560+330
1.50	793.4	750+43
1.60	714.3	680+33
1.70	649.5	620+30
1.80	595.5	560+36

### Output Voltage Remote Sense Function

The MYTNA1R86RELA2RA has a sense pin, +Sense, for this function. The function is capable of compensating for the voltage drop in the wiring by connecting the sense pin to the load point. The upper limit of the compensating by sense function depends on the maximum voltage allowed to the Vout pin (within range of the Output Voltage Accuracy). The sense trace should be as short as possible and shielded by the GND line or something else to reduce noise susceptibility.

The recommended sense line length is within 10cm for output voltage stability. Do NOT connect sense pin to the output of the additional LC filter that sits between the Vout pin and +Sense pin. If the remote sense is not needed, the +Sense pin should be shorted to the Vout pin.

**Remote Enable Function**

The MYTNA1R86RELA2RA has an enable input pin, ON/OFF, which is designed to be compatible with the low voltage digital I/O levels so that it can be easily driven by an external controller. The ON/OFF pin logic is high active and connected to the VIN through internal resistors. So if external power sequencing or control is not required, the ON/OFF pin can be left open.

**Soft Start Function**

The MYTNA1R86RELA2RA has a soft start function. This function suppresses the inrush current and the output voltage overshoot. When the function is operating, the converter is controlled in discontinuous current mode (DCM), so the output ripple voltage may be larger than steady-state behavior which is in continuous current mode (CCM). If the input voltage drops and the operating condition deviates from the supported operation range of fig.9 “Output Voltage Range”, you should discharge the input voltage below the VIUVL and then restart.

This soft start function is also compatible with pre-bias start-up. However the converter cannot prevent reverse current except during soft start, so the output must NOT be connected to a circuit that has a voltage higher than the output voltage setting.

**Power Good Operation**

MYTNA1R86RELA2RA has an open-drain “power good” pin, POK. The POK pin must be pulled up externally, though a resistor to a voltage of  $\leq 5.5V$ . MYTNA1R86RELA2RA will hold the POK pin low during soft start, the VOUT is outside of the regulation or when the fault condition is detected and being handled. Please note that the power good function will not work when the module is inactive. Therefore, the POK pin will be high impedance when the VIN is below the VIUVH or the module disabled.

The power good function is activated after soft start has finished. If the VOUT becomes within +5 to -5% of the target value, internal comparators detect the power good state and the power good signal becomes high. After that, if the VOUT rises outside of +10% or falls outside of -10% of the target value, the power good signal becomes low.

The power good function is a flag that indicates the output voltage status and internal protection status. If the POK pin isn't high for a long time from start-up, there are some abnormal situation occur in inside the module or external environment.

So, we recommend monitoring the POK pin, and reset the module and the output load in abnormal.

**Protections**

MYTNA1R86RELA2RA provides extensive and robust protection against input and output faults and over-temperature conditions, as summarized in the following table.

**Table 10. Fault Protection Detection Time and Responses**

FAULT MODE	PROTECTION	FAULT RESPONSE	FAULT DETECTION TIME
VIN Under-Voltage	Under voltage Lock out	Power-on reset	Immediate (VIN falling)
Over Load	Over current protection	POK de-asserted; Enter hiccup mode	1ms
Output Short	Short circuit protection	POK de-asserted; Enter hiccup mode	Immediate
Over Temperature	Over temperature protection	POK de-asserted; Enter hiccup mode	160μs

The protection does not guarantee the module operation within the recommended operating conditions. Even if the protection is operating, it may exceed the conditions, and thus may reduce the reliability of the module.

**Over Current Protection and Short Circuit Protection**

MYTNA1R86RELA2RA provides output over current protection and short circuit protection for load fault. When the converter load current exceeds the over current threshold for the detection time, the converter output is shut down. Following the shutdown, the converter periodically tries to recover by the startup sequence. This mode is called "hiccup" mode and continues until the load current decreases to under the over current threshold. When hiccup mode releases, the converter returns to normal operation.

Short circuit protection is incorporated for times when more rapidly shutdown is needed as output short. When the converter load current exceeds the short circuit threshold, the converter shuts down immediately and operates in hiccup mode until the load current decreases to under the short circuit threshold. When the hiccup mode releases, the converter returns to normal operation.

**Over Temperature Protection**

MYTNA1R86RELA2RA includes an integrated temperature sensor to protect the system from overheating. Once the converter detects over temperature longer than 160 $\mu$ sec, the output is turned off to reduce the power dissipation of the module. When the temperature drops below the hysteresis limit, the output is turned on again. If the underlying cause of the over-temperature fault is not cleared, the system enters into hiccup mode until the fault condition is removed.

## Soldering Guidelines

Murata recommends the specifications below when installing this converter. These specifications vary depending on the solder type. Exceeding these specifications may cause damage to the product. Your production environment may differ, therefore, thoroughly review these guidelines with your process engineers.

**Table 11. Reflow Guidelines for Sn/Ag/Cu solders and Sn/Pb solders**

REFLOW SOLDER OPERATIONS FOR SURFACE MOUNT PRODUCTS	
For Sn/Ag/Cu based solders:	
Preheat Temperature	Less than 1degC per second
Time over Liquidus	45 to 75 seconds
Maximum Peak Temperature	260degC
Cooling Rate	Less than 3degC per second
For Sn/Pb based solder:	
Preheat Temperature	Less than 1degC per second
Time over Liquidus	60 to 75 seconds
Maximum Peak Temperature	235degC
Cooling Rate	Less than 3degC per second

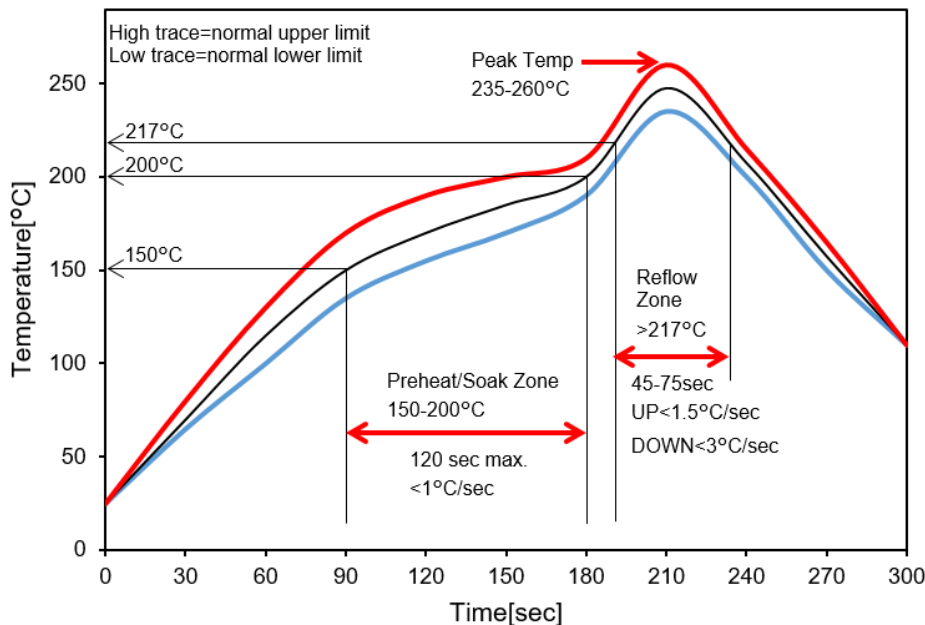

**Figure 10. Reflow Profile for Sn/Ag/Cu Solder**

### Pb-free Solder Processes

For Pb-free solder processes, the product is qualified for MSL 3 according to IPC/JEDEC standard J-STD-020C. During reflow, the module must not exceed 260degC at any time.

### Dry Pack Information

Products intended for Pb-free reflow soldering processes are delivered in standard moisture barrier bags according to IPC/JEDEC standard J-STD-033.

(Handling, Packing, Shipping and Use of Moisture, Reflow, and Process Sensitivity Devices).

Using products in high temperature Pb-free soldering processes requires dry pack storage and handling. In case the products have been stored in an uncontrolled environment and no longer can be considered dry, the products must be baked according to J-STD-033.

### Application Performance

The Application Performance data is reference and based on the Application Board in Figure 34.  
 $T_a=25\text{degC}$ , No forced air flow, unless otherwise noted.

$V_{OUT}=1.8\text{V}$

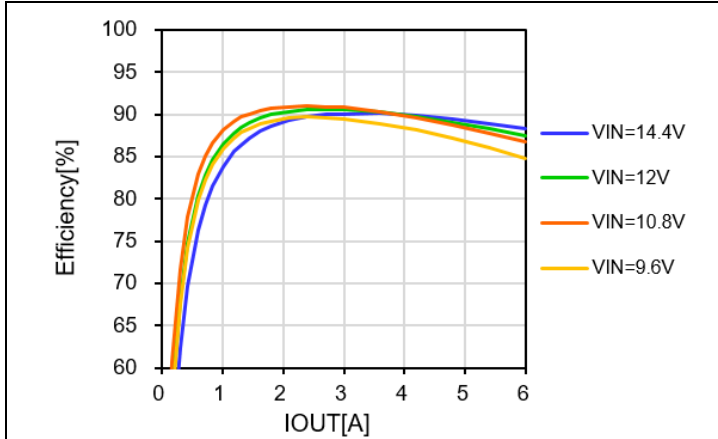

Figure 11. Efficiency vs. Load Current and Line Voltage

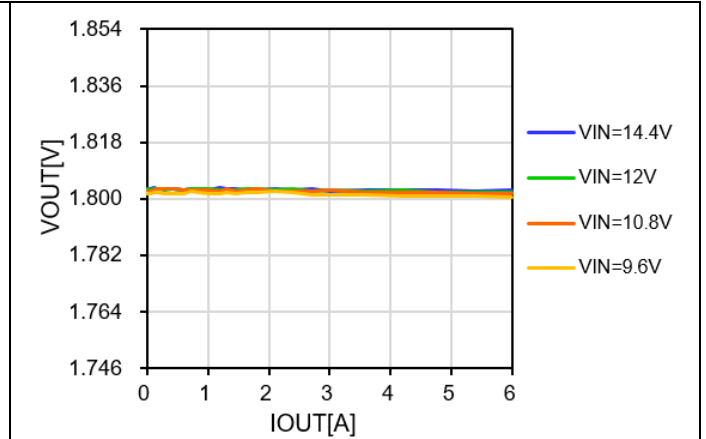

Figure 12.  $V_{OUT}$  vs. Load Current and Line Voltage

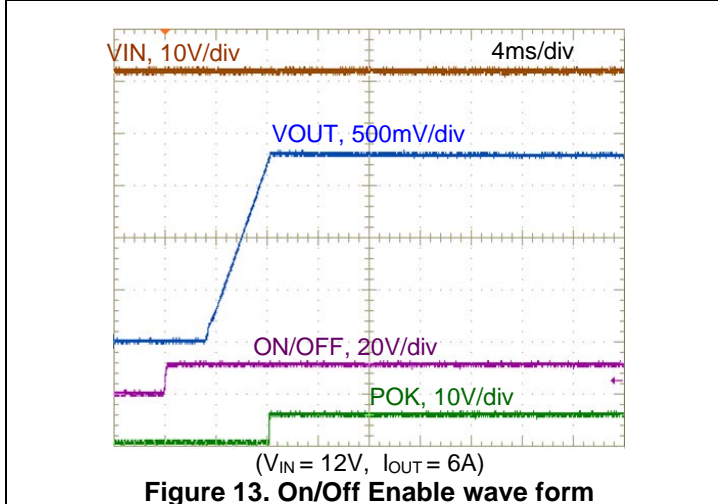

Figure 13. On/Off Enable wave form

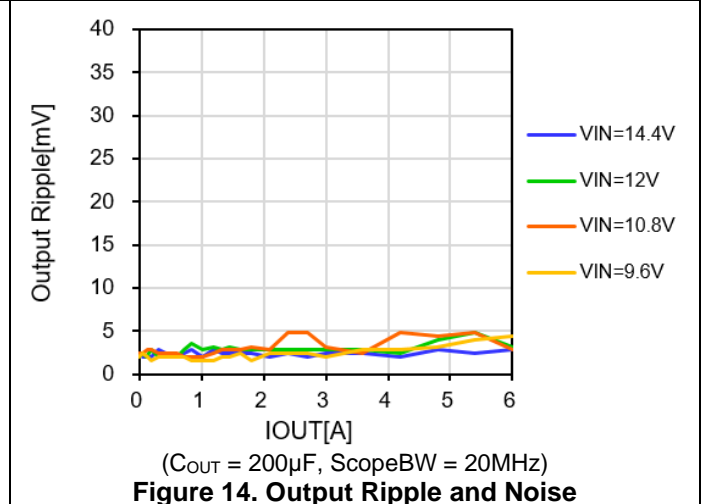

Figure 14. Output Ripple and Noise

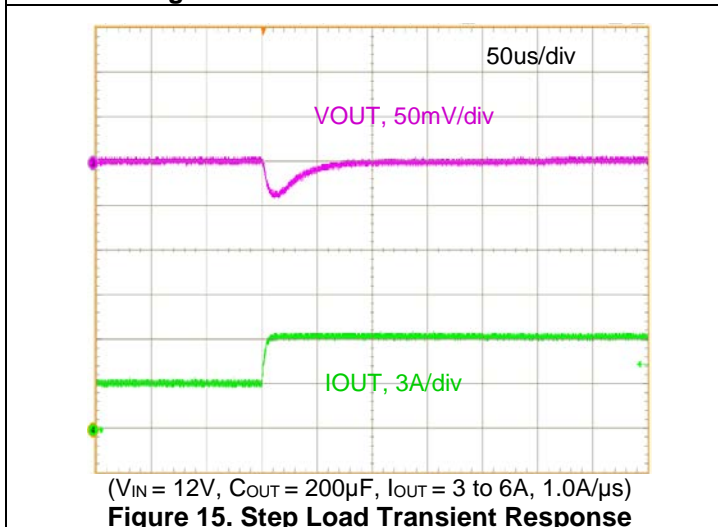

Figure 15. Step Load Transient Response

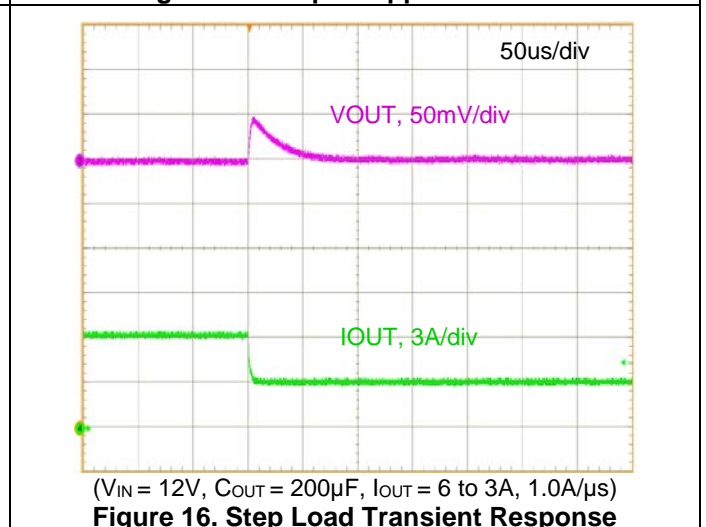

Figure 16. Step Load Transient Response



$V_{OUT}=1.2V$

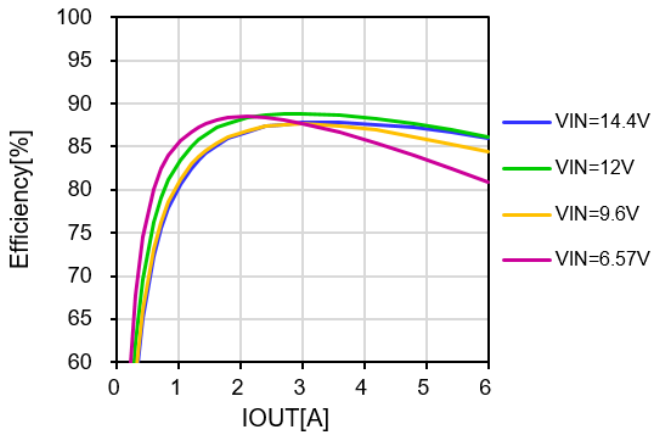

Figure 17. Efficiency vs. Load Current and Line Voltage

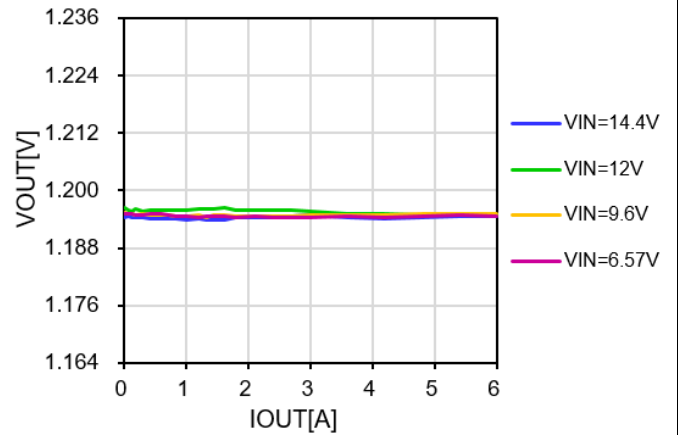

Figure 18.  $V_{OUT}$  vs. Load Current and Line Voltage

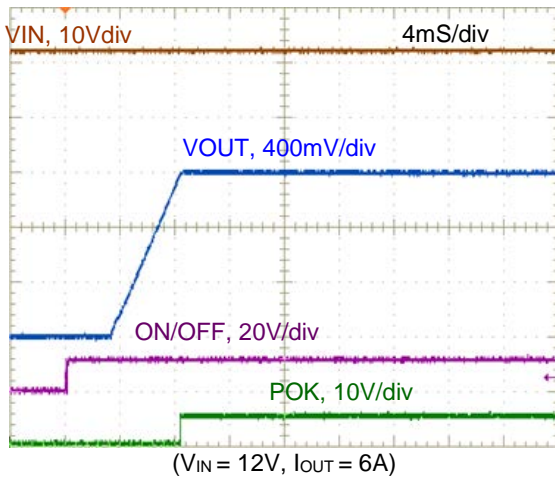

Figure 19. On/Off Enable wave form

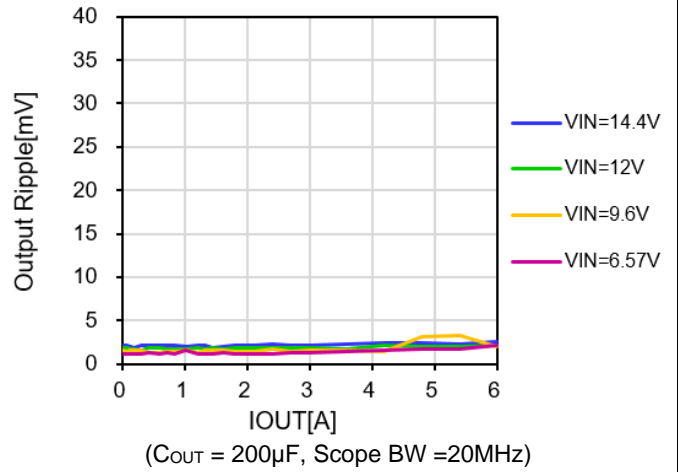

Figure 20. Output Ripple and Noise

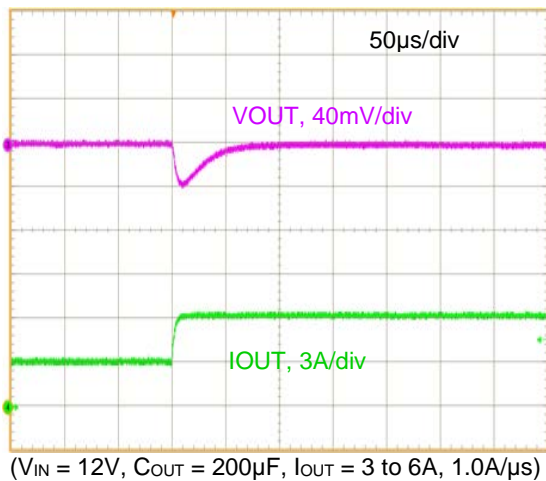

Figure 21. Step Load Transient Response

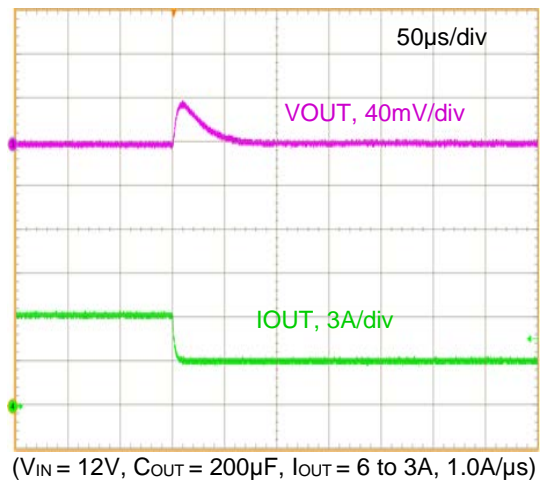

Figure 22. Step Load Transient Response

$V_{OUT}=0.7V$

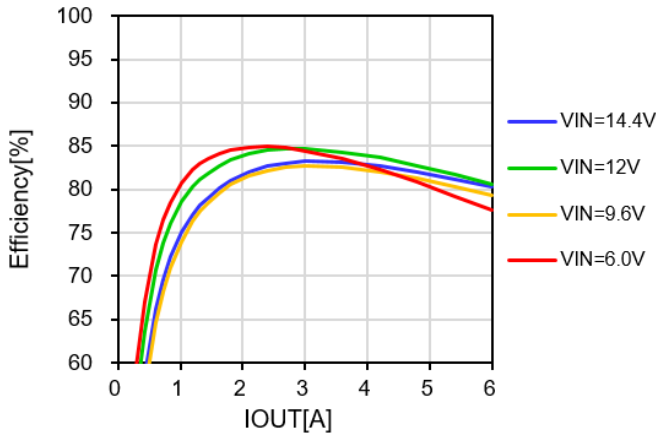

Figure 23. Efficiency vs. Load Current and Line Voltage

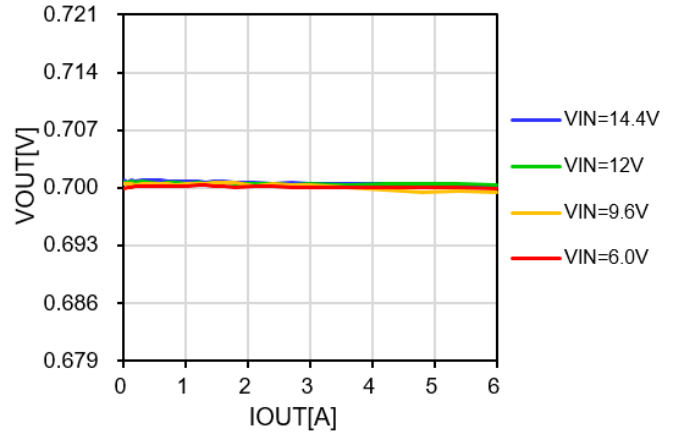

Figure 24.  $V_{OUT}$  vs. Load Current and Line Voltage

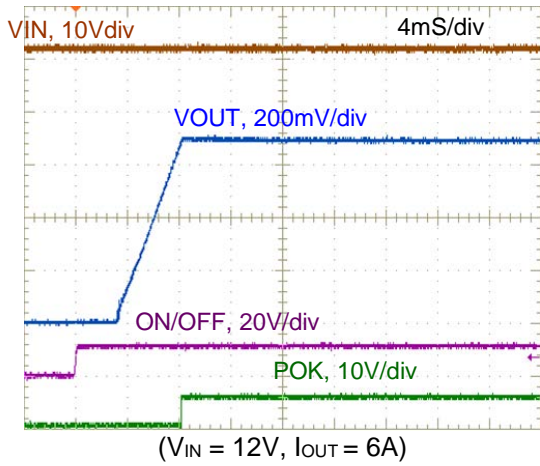

Figure 25. On/Off Enable wave form

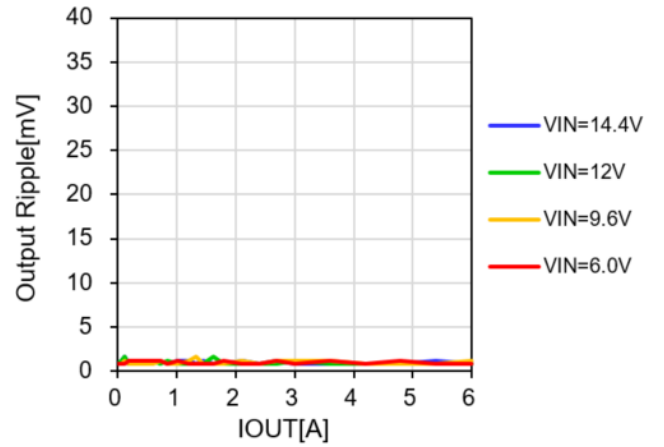

Figure 26. Output Ripple and Noise

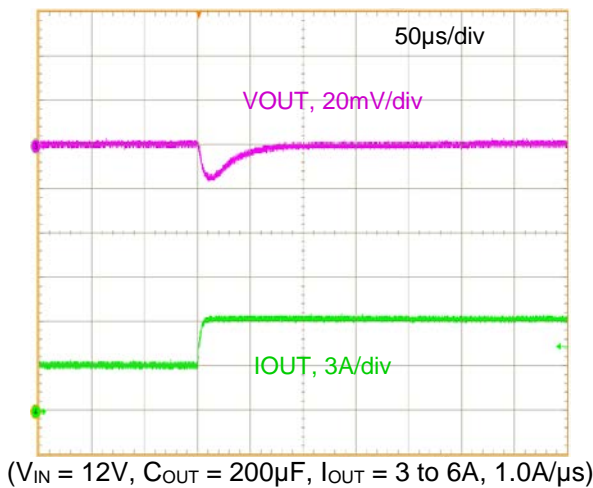

Figure 27. Step Load Transient Response

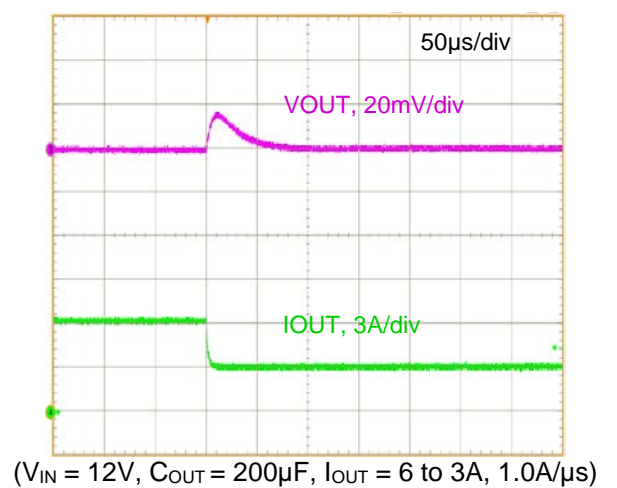

Figure 28. Step Load Transient Response

## Transient Performance

**Table 12. Transient Performance and Conditions**

V <sub>OUT</sub> [V]	V <sub>IN</sub> [V]	C <sub>OUT</sub> [μF]	VOLTAGE DEVIATION [mV]
			3A-6A LOAD STEP (1A/μs)
1.8	12	200	42.0
1.2			29.4
0.7			19.2

## Test Circuit

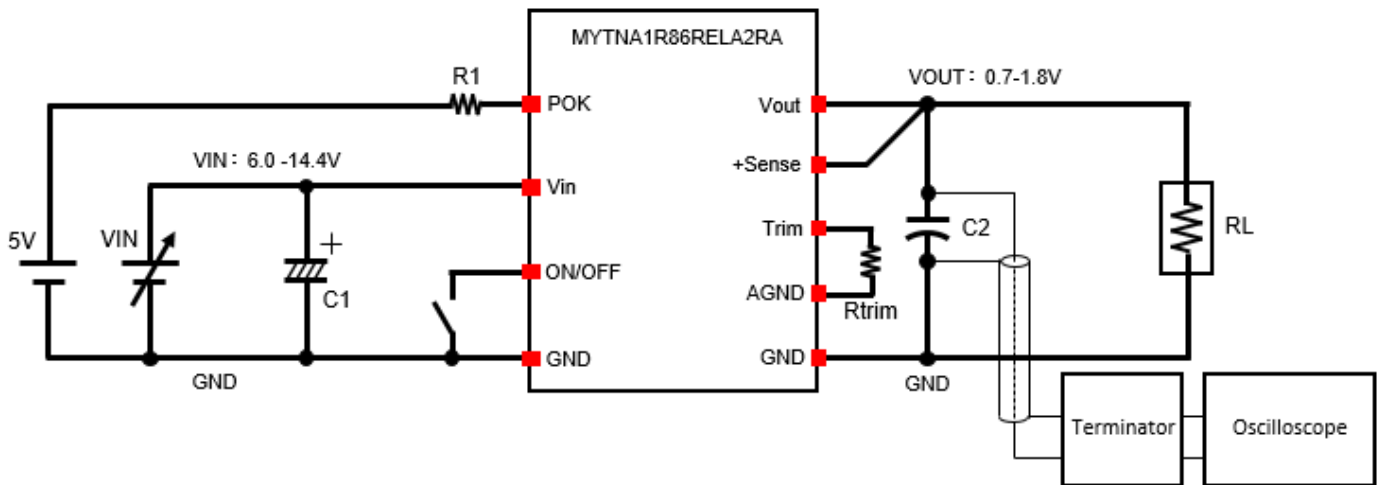

**Figure 29. Test Circuit**

**Table 13. Test Circuit Parts and Equipments List**

REFERENCE	VALUE	DESCRIPTION	PART AND EQUIPMENT
C1	1000μ	Electrolysis Capacitor	-
C2	100μ x 2pcs	CAP/CER/100uF/4V/X7U/3216M/20%	GRM31CE70G107MEA8 (Murata)
R1	100k	1/10W/5%	-
VIN	-	DC Power Supply	-
RL	-	Electronic Load Device	ELL-355(KeisokuGiken)
Oscilloscope	-	Digital Oscilloscope	DPO5034 or TDS5034(Tektronix)
Terminator	-	Terminator	TRC-50F2(KeisokuGiken)

## Component Selection

Users of MYTNA1R86RELA2RA should adhere closely to the parts selected for the reference design bill of materials (BOM). Component selection is a complex process, and several parameters of importance to the design are not typically specified for passive components. Users wishing to deviate from these components are urged to contact Murata for guidance.

### Input Fuse

Certain applications and/or safety agencies may require fuses at the inputs of power conversion components. Normally, the fuse should be inserted on the primary side input supply line. For greatest safety, we recommend a fast blow fuse installed in the ungrounded input supply line of this module too. The installer must observe all relevant safety standards and regulations.

For safety agency approvals, install the converter in compliance with the end-user safety standard.

### Input Capacitor

In general input environment (there are sufficient consideration about parasitic impedance and stability.), MYTNA1R86RELA2RA does not need an external input capacitor. If you want to reduce the ripple on input more, you can add the external input capacitor. The input capacitor should be placed as close to the module as possible to reduce any parasitic inductance effects. The voltage rating of the capacitor needs to be as high as the absolute maximum voltage rating for the system. The capacitor has voltage coefficient of capacitance, so you should be determine the rated value of capacitor that is taken into account the effective capacitance value at the applied VIN.

### Output Capacitor

We recommend a low-ESR ceramic (Murata GRM31 series) capacitor for output. The ceramic type capacitor may be tried using either single or multiple capacitors in parallel.

The converter will achieve its rated output ripple and noise with additional external capacitor. The user may install more external output capacitance to reduce the ripple even further or for improved dynamic response.

These capacitors should be placed as closely as possible to the converter, and the output ripple measured under your load conditions. Use only as much capacitance as required to achieve your ripple and noise objectives.

Excessive capacitance can make step load recovery sluggish or possibly introduce instability or start-up failure.

Do not exceed the maximum rated output capacitance listed in the specifications.

### Packaging Information

This section provides packaging data including the moisture sensitivity level, package drawing, package marking and tape-and-reel information.

#### Moisture Sensitivity Level

The moisture sensitivity level rating for the MYTNA1R86RELA2RA in the 10.5 x 9.0 x 2.1mm LGA package is MSL3.

#### Package Drawing

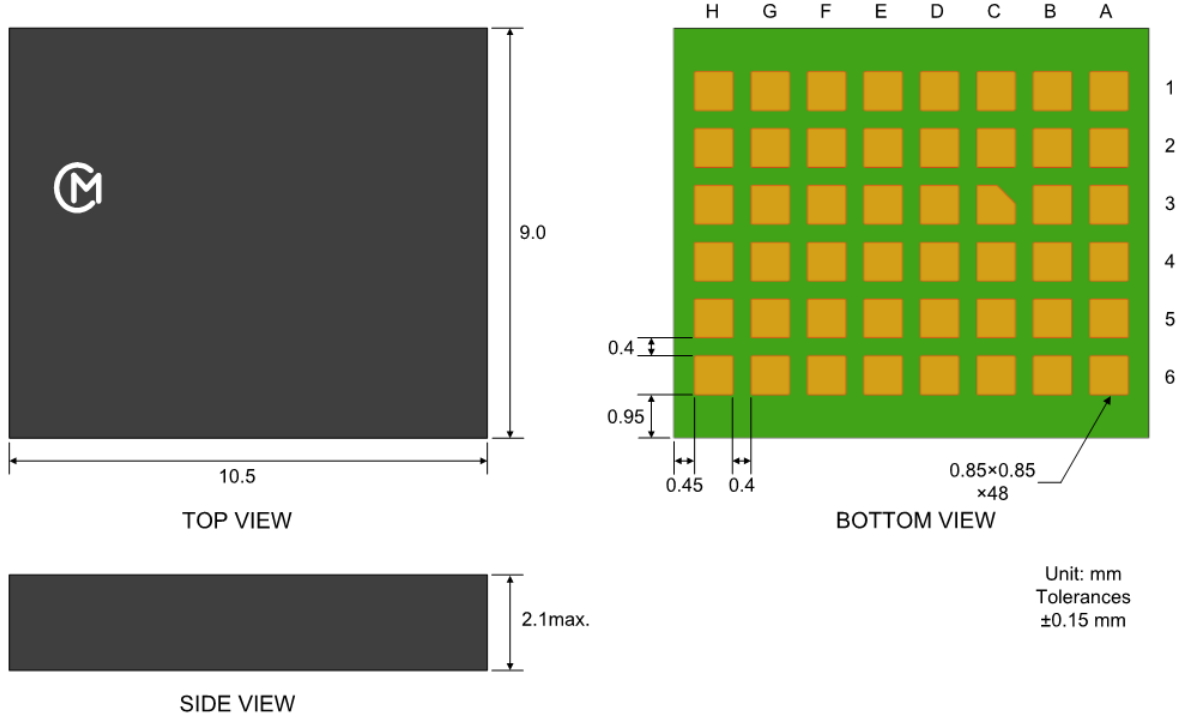

Figure 30. Package Outline Drawing

#### Recommended Board Land Pattern (Top View)

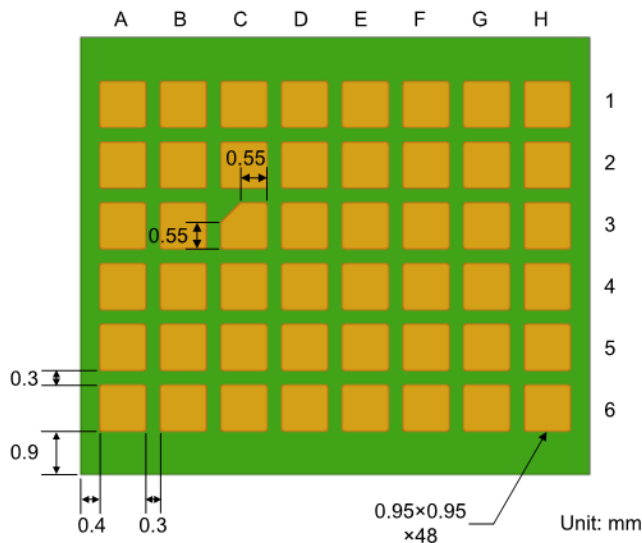
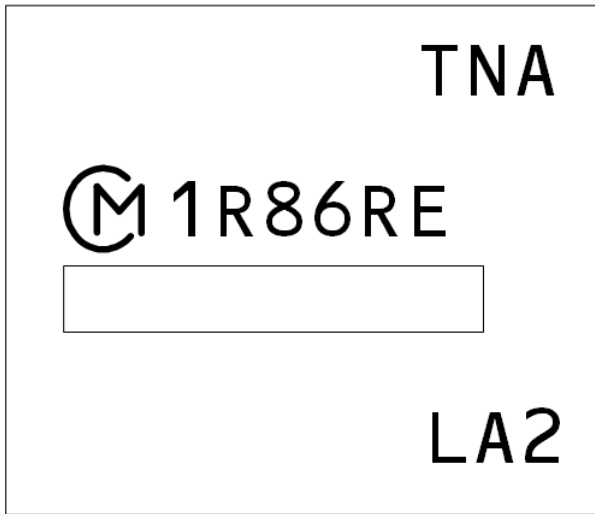

Figure 31. Recommended Board Land Pattern (Top View)

Top Marking Specification



CODES	DESCRIPTION
Ⓜ	Pin 1 Marking
TNA1R86RELA2	Product code (Please see product code table beside)
<input type="text"/>	Internal manufacturing code

PART NUMBER	PRODUCT CODE
MYTNA1R86RELA2RA	TNA1R86RELA2

Figure 32. Top Marking Specification

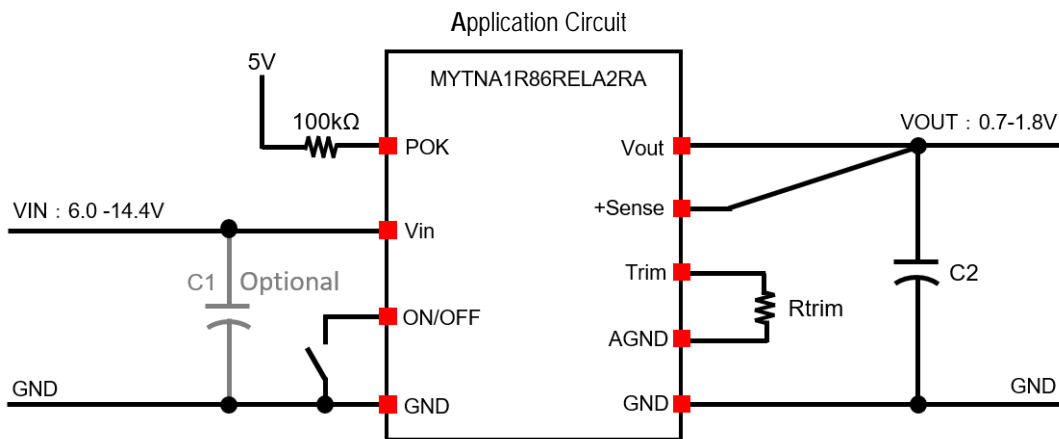

Figure 33. Application Schematic

Application Circuit Part List (Recommended)

Table 14. Application Circuit Part List

REFERENCE	VALUE	DESCRIPTION	PART NUMBER
C1	1000u	Electrolysis Capacitor (Optional) <sup>(1)</sup>	-
C2	100u x 2pcs	CAP/CER/100μF/4V/X7U/1206/20%	GRM31CE70G107MEA8 (Murata)
Rtrim	-	Chip resistor/1/10W/0.5%	RK73G1ETTP***D(KOA)

(1) If there is a non-negligible parasitic impedance between the power supply and the converter, such as during evaluation, the optional input capacitor "C1" may be required to reduce the impedance. The recommended optional capacitor is an example. Please consider the optimum value for the case. This capacitor is usually an aluminum electrolytic type. It isn't necessary to place the capacitor near the input terminal of the converter.



Application Board Example

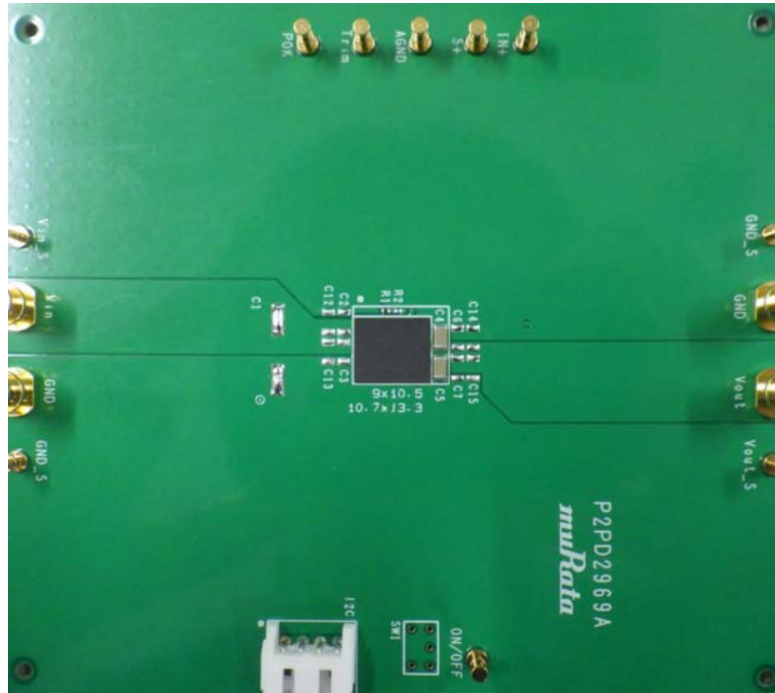

Figure 34. Application Board Example (Based on JEDEC standard)  
114.5 x 101.5 x 1.6mm (4 Layer FR-4)  
Outside copper(1,4) layer = 2oz, Inner copper(2,3) layer = 1oz

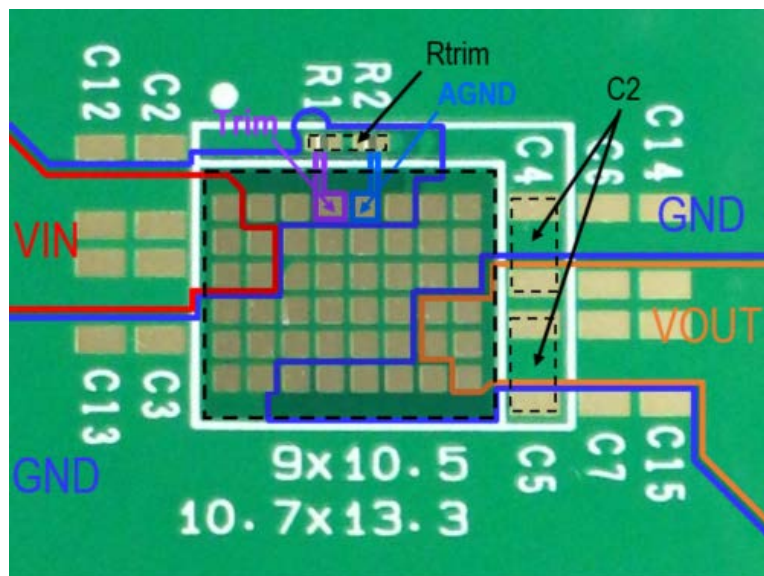
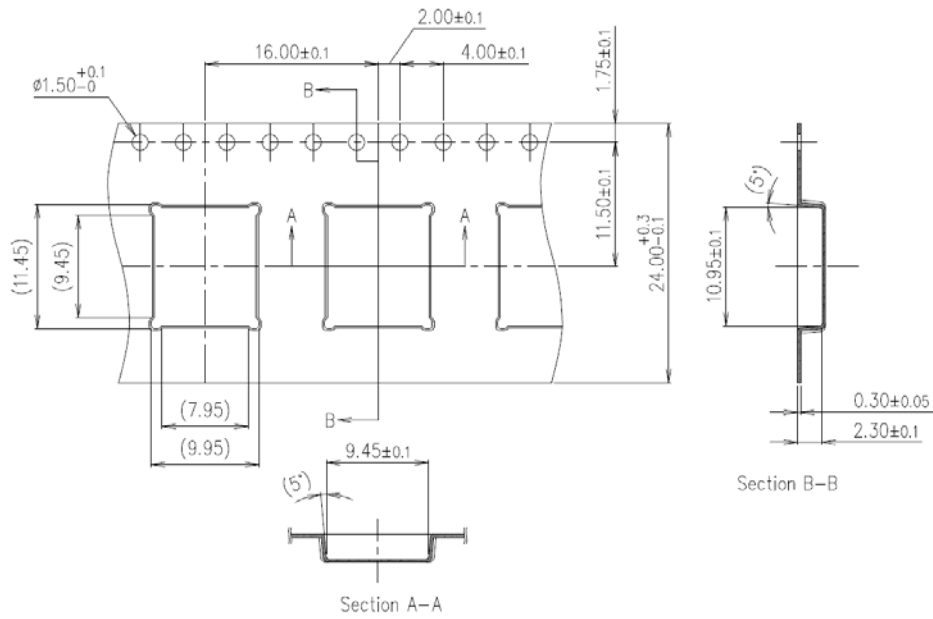

Figure 35. Land Pattern Example

**Tape and Reel Specification**

**Tape Dimension**



**Figure 36. Tape Dimension**

**Reel Dimension**

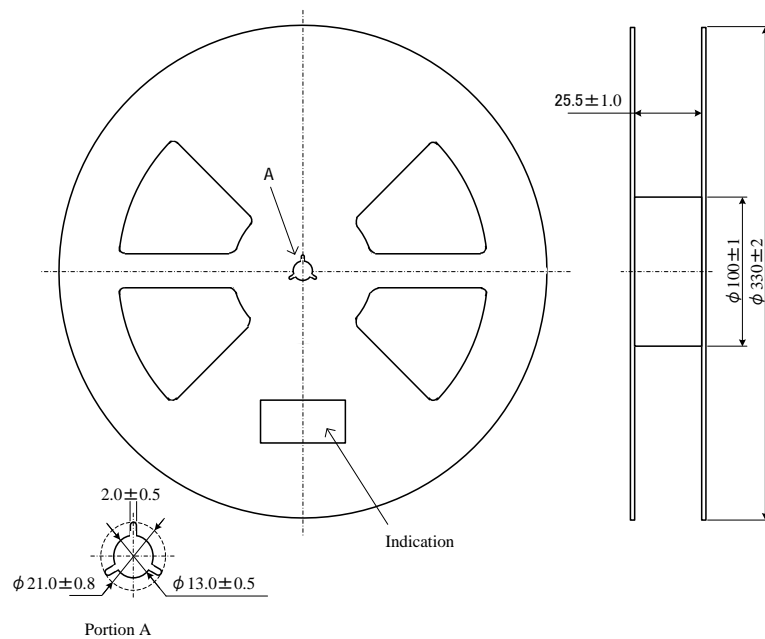

**Figure 37. Reel Dimension**



**Device orientation in Tape**

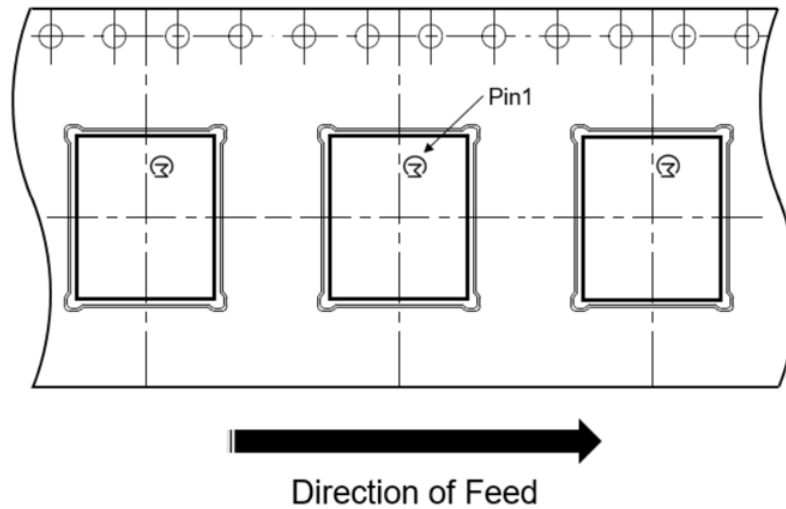

**Figure 38. Module Orientation in Tape**

**Taping specification**

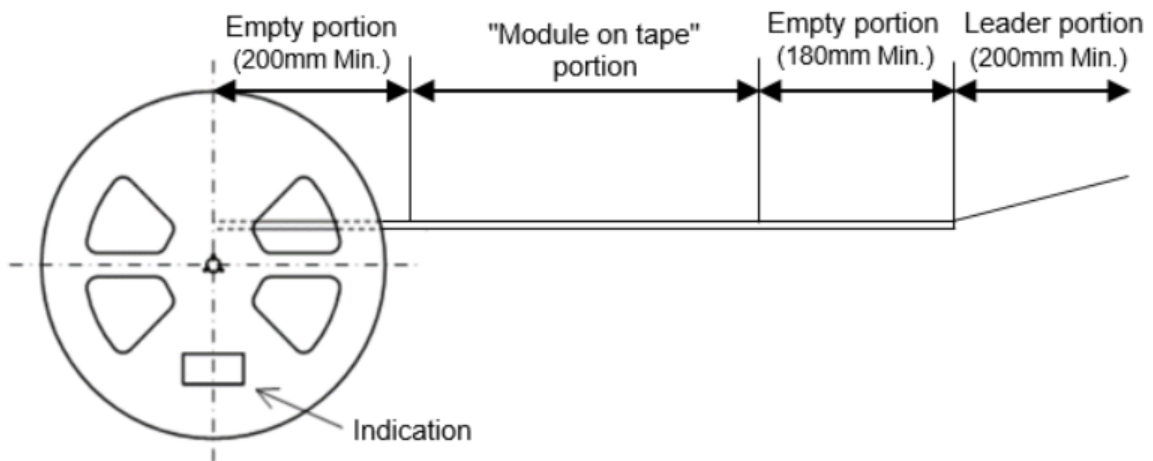

**Figure 39. Taping Specification**

1. The adhesive strength of the protective tape is within 0.3-1.0N.
2. Each reel contains 400 or 100pcs.
3. Each reel set in moisture-proof packaging because of MSL 3.
4. No vacant pocket in “Module on tape” section.
5. The reel is labeled with Murata part number and quantity.
6. The color of reel is not specified.

**Order Codes**

**Table 15. Order Codes**

ORDER CODES	DESCRIPTION	PACKAGING	SHIPPING METHOD
MYTNA1R86RELA2RA	MYTNA1R86RELA2RA Buck Converter	10.5 x 9.0 x 2.1mm LGA	400 units/T&R
MYTNA1R86RELA2RAD	MYTNA1R86RELA2RA Buck Converter	10.5 x 9.0 x 2.1mm LGA	100 units/T&R

## Revision History

REV	DATE	DESCRIPTION	PAGE NUMBER
A02	JUL-2023	Add Performance Specifications Summary Add Part Number Structure Add Scope Updated Limitation of Applications Add Fail-Safe function	P3 P3 P27 P27 P28

## Notices

### Scope

This datasheet is applied to MYTNA1R86RELA2RA and MYTNA1R86RELA2RAD.  
- Specific applications: Consumer Electronics, Industrial Equipment

 CAUTION

### Limitation of Applications

The products listed in the datasheet (hereinafter the product(s) is called the "Product(s)") are designed and manufactured for applications specified in the specification or the datasheet. (hereinafter called the "Specific Application"). We shall not warrant anything in connection with the Products including fitness, performance, adequateness, safety, or quality, in the case of applications listed in from (1) to (11) written at the end of this precautions, which may generally require high performance, function, quality, management of production or safety. Therefore, the Product shall be applied in compliance with the specific application.

We disclaim any loss and damages arising from or in connection with the products including but not limited to the case such loss and damages caused by the unexpected accident, in event that (i) the product is applied for the purpose which is not specified as the specific application for the product, and/or (ii) the product is applied for any following application purposes from (1) to (11) (except that such application purpose is unambiguously specified as specific application for the product in our catalog specification forms, datasheets, or other documents officially issued by us\*).

- (1) Aircraft equipment
- (2) Aerospace equipment
- (3) Undersea equipment
- (4) Power plant control equipment
- (5) Medical equipment
- (6) Transportation equipment (such as vehicles, trains, ships)
- (7) Traffic control equipment
- (8) Disaster prevention / crime prevention equipment
- (9) Industrial data-processing equipment
- (10) Combustion/explosion control equipment
- (11) Application of similar complexity and/or reliability requirements to the applications listed in the above

For exploring information of the Products which will be compatible with the particular purpose other than those specified in the datasheet, please contact our sales offices, distribution agents, or trading companies with which you make a deal, or via our web contact form.

Contact form: <https://www.murata.com/contactform>

\*We may design and manufacture particular Products for applications listed in (1) to (11). Provided that, in such case we shall unambiguously specify such Specific Application in specification or datasheet without any exception. Therefore, any other documents and/or performances, whether exist or non-exist, shall not be deemed as the evidence to imply that we accept the applications listed in (1) to (11).

## Fail-Safe Function

Be sure to add an appropriate fail-safe function to your finished product to prevent secondary damage in the unlikely event of an abnormality function or malfunction in our product.

Please connect the input terminal by right polarity. If you mistake the connection, it may break the DC-DC converter. In the case of destruction of the DC-DC converter inside, over input current may flow. Please add a diode and fuse as following to protect them.

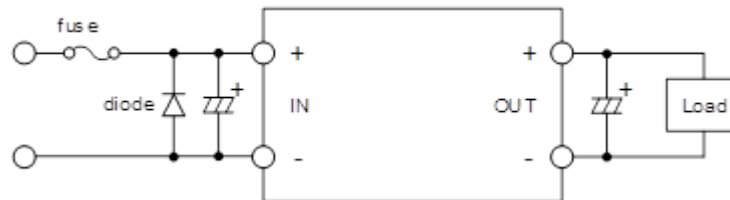

Please select diode and fuse after confirming the operation.

**Figure 40. Circuit example with a diode and fuse**



### Note

1. Please make sure that your product has been evaluated in view of your specifications with our product being mounted to your product.
2. You are requested not to use our product deviating from the reference specifications.
3. If you have any concerns about materials other than those listed in the RoHS directive, please contact us.
4. Please don't wash this product under any conditions.

## Product Specification

Product Specification in this datasheet are as of July 2023. Specifications and features may change in any manner without notice. Please check with our sales representatives.

## Contact form

<https://www.murata.com/contactform?Product=Power%20Device>

## Disclaimers

The information described in this datasheet was carefully crafted for accuracy. However this product is based on the assumption that it will be used after thoroughly verifying and confirming the characteristics and system compatibility. Therefore, Murata is not responsible for any damages caused by errors in the description of the datasheet.

Murata constantly strives improve the quality and reliability of our products, but it is inevitable that semiconductor products will fail with a certain probability. Therefore regardless of whether the use conditions are within the range of this datasheet, Murata is not responsible for any damage caused by the failure of this product.,(for example, secondary damage, compensation for accidents, punitive damage, loss of opportunity, and etc.) Also, regardless of whether Murata can foresee the events caused by the failure of our product, Murata has no obligations or responsibilities.

The buyer of this product and developer of systems incorporating this product must analyze, evaluate, and make judgements at their own risk in designing applications using this product. The buyer and the developer are responsible for verifying the safety of this product and the applications, and complying with all applicable laws, regulations, and other requirements.

Furthermore, the buyer and developer are responsible for predicting hazards and taking adequate safeguards against potential events at your own risk in order to prevent personal accidents, fire accidents, or other social damage. When using this product, perform thorough evaluation and verification of the safety design designed at your own risk for this product and the application.

Murata assumes that the buyer and developer have the expertise to verify all necessary issues for proper use of the product as described above and to take corrective action. Therefore, Murata has no liability arising out of the use of the product. The buyer and developer should take all necessary evaluations, verifications, corrective actions and etc., in your own responsibility and judgment.

This datasheet does not guarantee or grant any license to the information, including patents, copyrights, and other intellectual property rights, of the Murata or third parties. Regardless of whether the information described in this datasheet is express or implied, Murata does not take any responsibility or liability for any claims, damages, costs, losses, etc. Relating to intellectual property rights or other rights from third parties due to the use of these information.

This product has an original datasheet written in Japanese. If any uncertainties and/or suspicions arises about this English-language datasheet, all judgments will be based on the datasheet described in Japanese.

## Patent Statement

Murata products are protected to one or more of the U.S. patents.

## Copyright and Trademark

©2023 Murata Manufacturing Co., Ltd. All rights reserved.



This product is subject to the following [operating requirements](#) and the [Life and Safety Critical Application Sales Policy](#). Refer to: <https://www.murata.com/products/power/requirements>

Murata Manufacturing Co., Ltd makes no representation that the use of its products in the circuits described herein, or the use of other technical information contained herein, will not infringe upon existing or future patent rights. The descriptions contained herein do not imply the granting of licenses to make, use, or sell equipment constructed in accordance therewith. Spec and cautions are subject to change without notice.