

Peak Emission Wavelength: 1200nm



Description

- Size 1206: 3.2 (L) x 1.6 (W) x 1.2 (H) mm
- Circuit substrate: glass laminated epoxy
- Devices are RoHS conform
- Lead free solderable, soldering pads: gold plated
- Marking at anode
- High radiation intensity types

Absolute Maximum Ratings (Ta=25°C)



ITEMS	SYMBOL	RATINGS	UNIT
Forward DC Current	If	50	mA
Peak Forward Current *	Ifp	100	mA
Reverse Voltage	Vr	5	V
Reverse Current	Ir	100	uA
Operating Temperature	Top	-40 to +85	°C
Storage Temperature	Tst	-55 to +85	°C
Thermal Resistance	RthJA	450	K/W

* tp ≤ 100 us, T=1ms

Electrical & Optical Characteristics (Ta = 25°C)

ITEMS	SYMBOL	CONDITION	MIN	TYP	MAX	UNIT
Forward Voltage	Vf	If=50mA	--	1.1	--	V
Peak Wavelength	λp	If=50mA	--	1300	--	nm
Radiant Power	Φe	If=50mA	--	11	--	mW
Spectral Bandwidth	Δλ0.5	If=50mA	--	78	--	nm
Viewing Angle	φ	If=50mA	--	40	--	deg

Package Dimensions

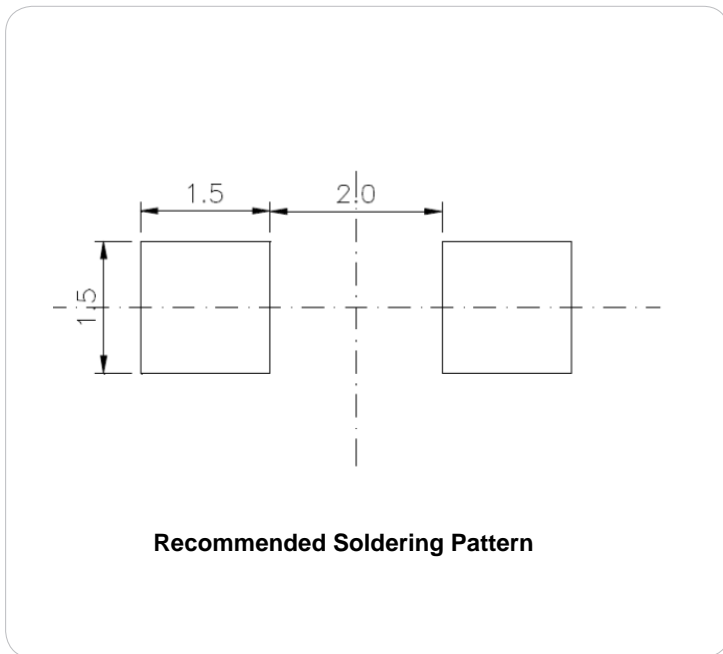
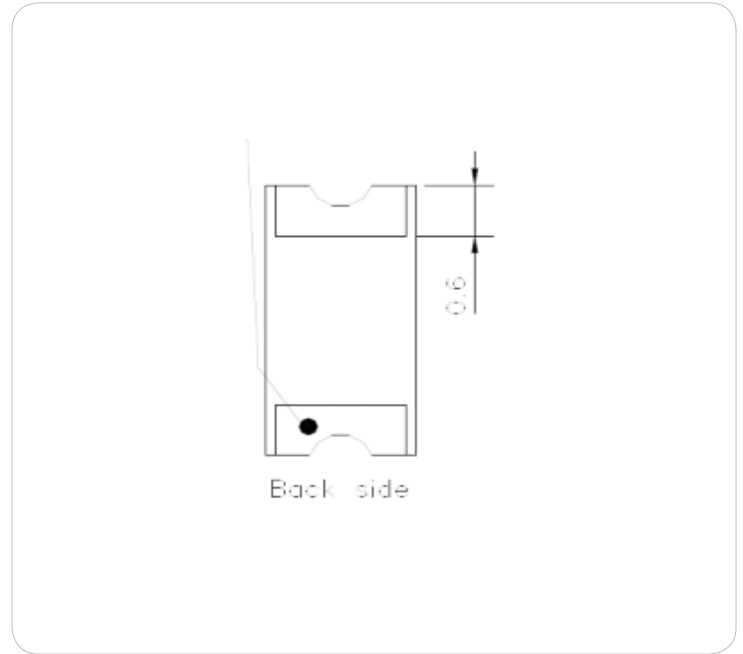
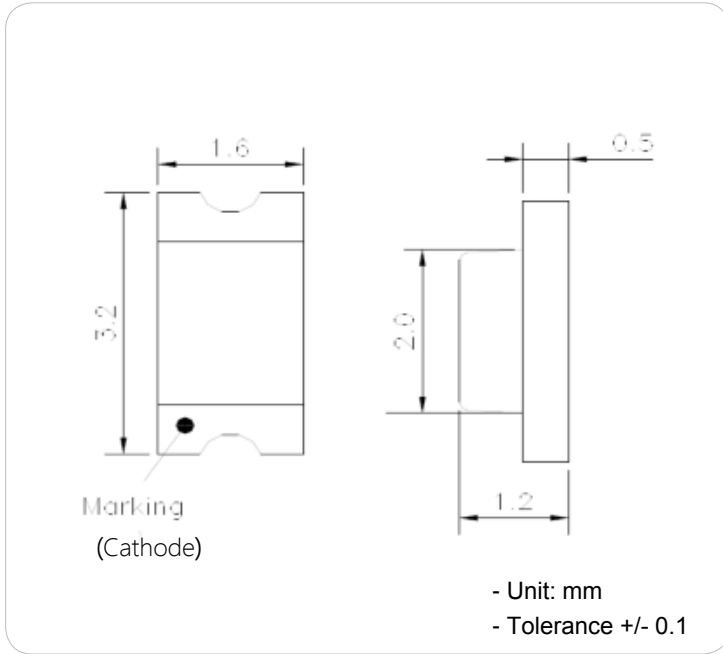

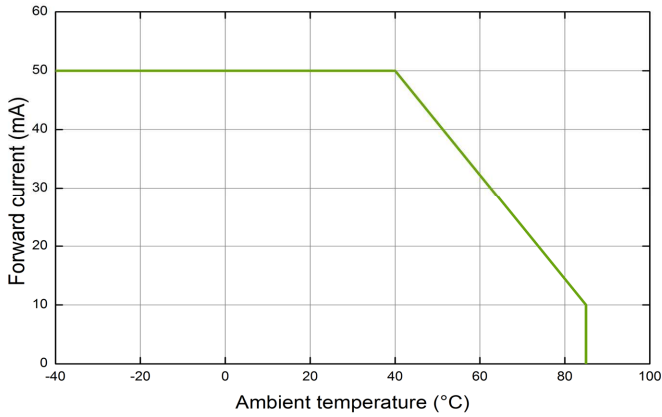

Max. forward current vs. ambient temperature

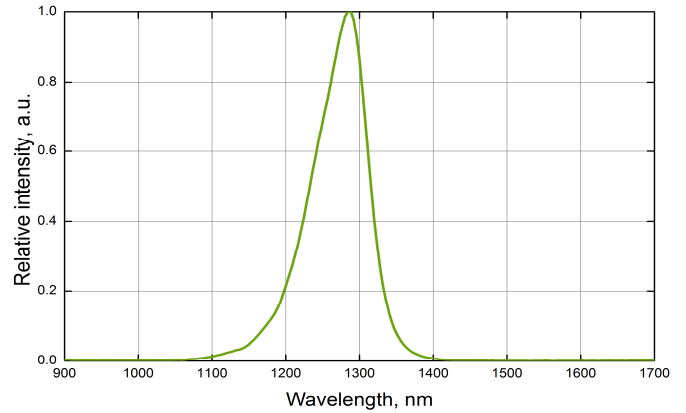

Typical spectrum at 50 mA

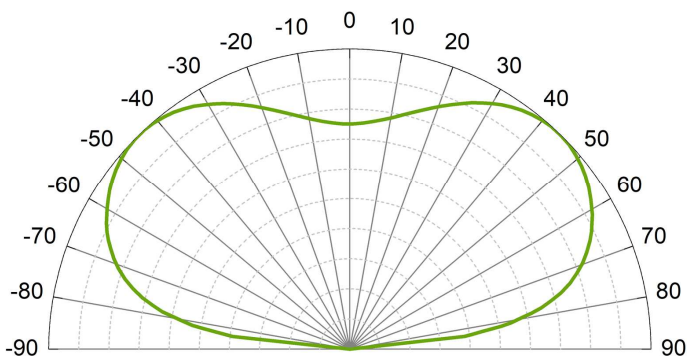

Radiation pattern

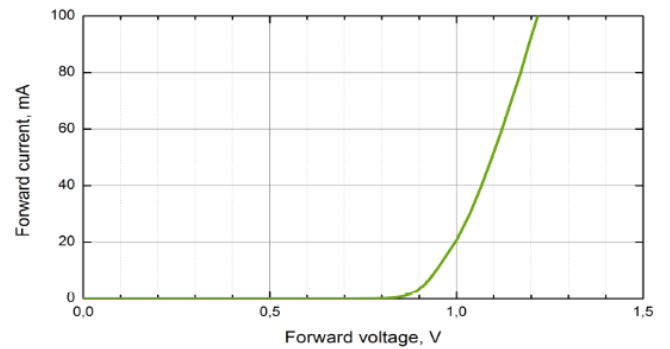

Forward current vs. forward voltage

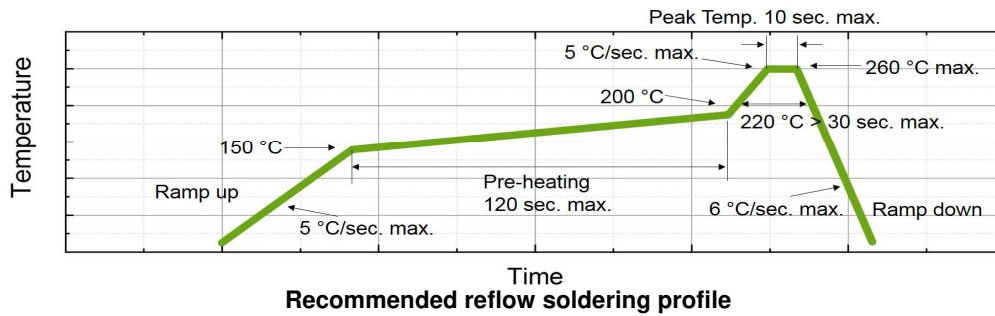

Measured according to CIE 127. All SMD LEDs are 100% measured and selected on full automated equipment with an accuracy of $\pm 11\%$.

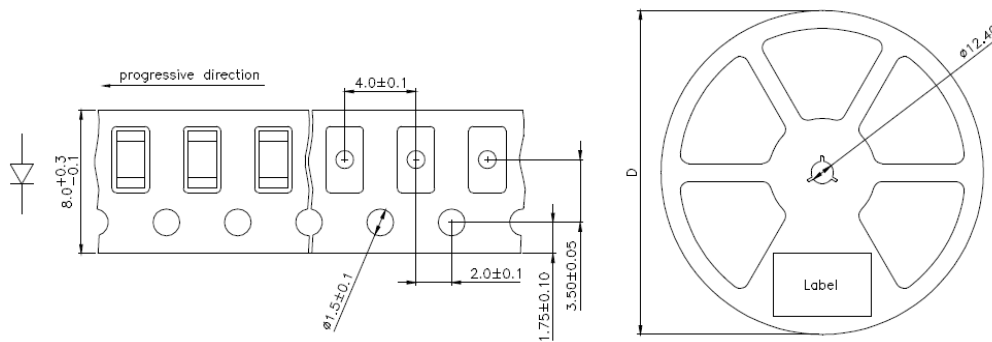

D	Parts / reel
180 mm	3000
330 mm	12000

Tape and reel packing

Packing: The reel is seaLED in special plastic bag with integrate ESD protection (MIL - STD 81705) including a silica dry-pack