



Midas Touch

magic embedded

We are dedicated to developing sensing technology, and providing customers with an innovative and diverse range products.

With the state-of-the-art algorithm technology, there are many brand products with our advanced image technology in the market.

MTP-8062 80*62 Thermal
Sensor Module Datasheet

Midas Touch, Inc.

17F-16, No. 1, Sec. 1., Zhongshan Rd., Banqiao Dist.,
New Taipei City 22063, Taiwan, R.O. C.

Email: contact@midastouchinc.com

Tel: +886-2-729-4139 Fax: +886-2-7729-4149



Revision History

Date	Revision	Contents
2021/2/15	V1.0	First release



1. Device Overview

MTP-8062-V1 Camera Module has a digital interface and no shutter. The patented fabrication and WLVP packaging ensure low cost of ownership, enabling many new applications to exploit LWIR sensors. It can be difficult to ascertain the “real world” performance of a thermal sensor from its device characteristics.

Meridian Innovation believes it is important to set the correct user expectation. Our devices are designed to be able to measure temperature of a black body to accuracy of +/- 1°C or with a maximum deviation amongst detectors of less than +/- 2°C

2. Key Specification

Detector	Resolution	80 (H) x 62 (V)
	IR Wavelength	8 - 14µm (Thermal LWIR)
	Detector pitch	45µm (H) x 45µm (V)
	Temperature accuracy	up to +/-1°C
	Maximum frame rate	25 FPS
	NETD (Ge Lens)	150mk
	Number of dead detectors	1%
Environmental	Max scene temperature range	-40°C to 1000°C
	Operating temperature	-20 ~ 65°C
	Storage temperature	-40 ~ 85°C
	Relative Humidity	TBD
Interface	Interface	USB2.0 / SPI
	Power Consumption	≤ 500mW
	Power supply	5.0V



	Frequency	<1 Hz
Mechanical	Camera Module Size	17.03 x 13 x 10.9mm
	Processor Board Size	30 x 30 x 4.8mm
	FOV	44° x 35° (Diagonal 55°)
	Weight	g

3. MTP-8062-V1 Interanl Connections

The following diagram provides a high-level view of the physical and electrical connections within components of the MTP-8062-V1

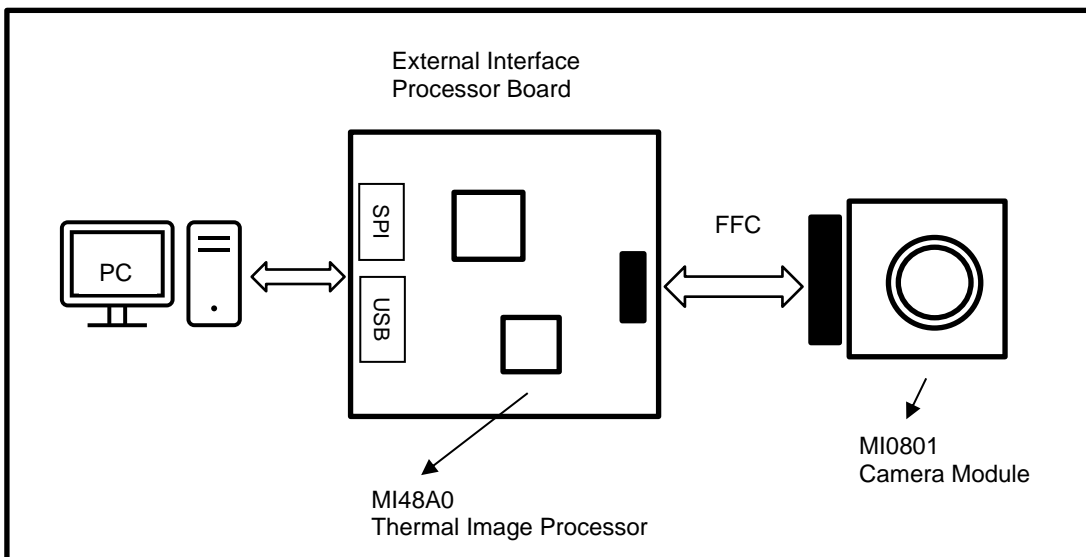
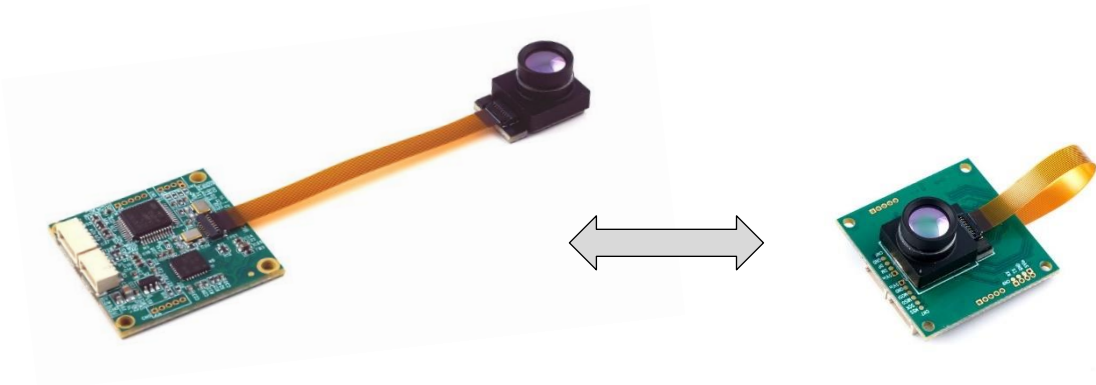



4.1 MI0801 Camera Module – Bobcat

The MI0801 Camera Module is a thermal imaging sensor, Capable of capturing 80x62 (4,960)-pixel images of long wave infrared radiation (LWIR). It is factory calibrated and has a completely digital interface. No mechanical shutter is employed nor required. Its patented fabrication and wafer-level vacuum packaging ensures low cost of ownership, enabling many new applications to employ LWIR thermal imaging technology.



4.2 MI48A0 Thermal Image Processor (TIP)

The MI48A0 TIP is a Meridian Innovation product made specifically to interface with the MI0801 Camera Module as a companion chip. It is a 5mm by 5mm QFN32 chip with a bottom thermal pad and is expected to be electronically connected to the corresponding signal pins of the MI0801 Camera Module. This companion chip performs all the low-level computations and signal timing required to process the raw data from the MI0801 Camera Module, thus removing this burden from any external processors.

The MI48A0 TIP also provides the external interface which is made up of common electrical buses and interfaces. The serial peripheral interface (SPI) bus is provided to transfer thermal image data with the MI48A0 TIP as a SPI slave device. The Inter-Integrated Circuit (I2C) bus is provided to control MI0801 module parameters. The DATA_READY Interrupt is a digital signal output from the MI48A0 TIP to alert the external processor of available image data for reading.

4.3 Drawing of MI0801 Camera Module

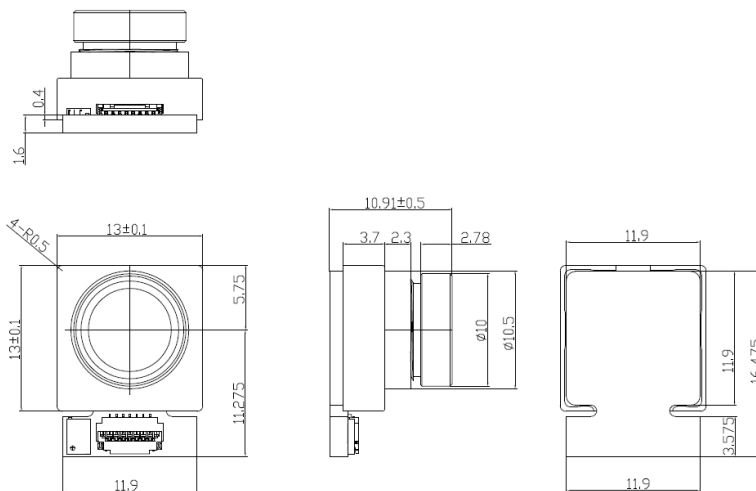



4.4 Optical viewing angle

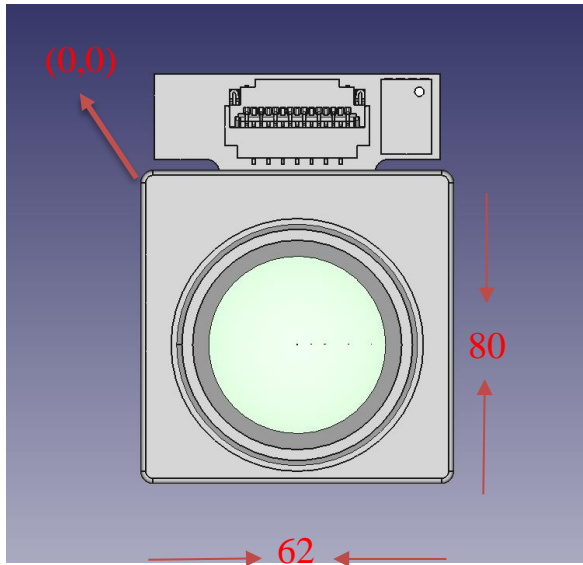

5.1 MTP-8062 Thermal Image Processor Board

The MTP-8062 thermal image processor board demonstrates the skills of the MI0801 camera module and MI48A0. The external interface also provides standard 1.0mm 5-pin USB and 1.0mm 6-pin SPI header connectors, which can be easily connected to any system.

5.2 Drawing of MTP-8062 Thermal Image Processor Board

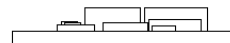
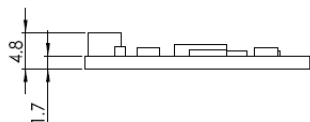
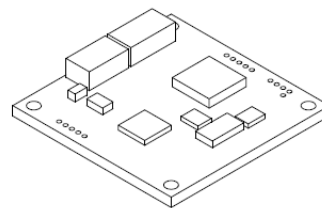
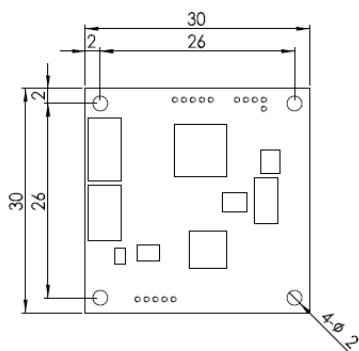



6. Pin Description



(CN1) The USB interface signals are :

Pin Number	Name	Pin Type	Function Description
1	VCC	Power	USB Power Supply 5V
2	D-	DM Pin	USB Data Transmission
3	D+	DP Pin	USB Data Transmission
4	GND	GND	System Ground
5	NC	NC	

(CN2) The SPI interface signals are :

Pin Number	Name	Pin Type	Function Description
1	NSS	Out	SPI – Slave select
2	SCK	In	Serial clock from host
3	MISO	Out	Serial data from MI0801 to host
4	MOSI	In	Serial data from host to MI0801
5	GND	GND	System Ground
6	VCC	Power	USB Power Supply 5V



7. Connector Specification

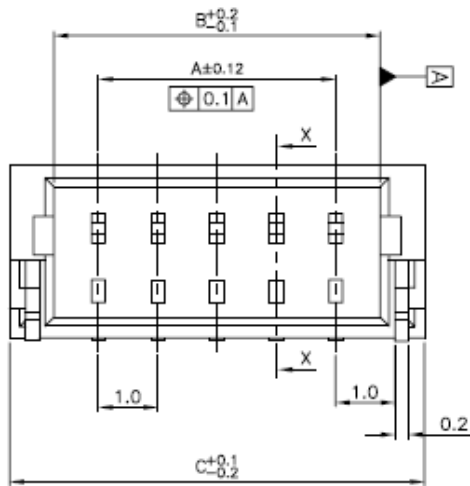
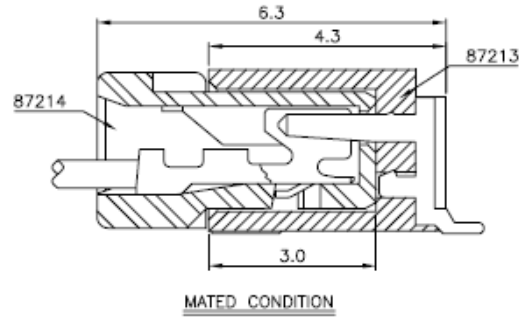
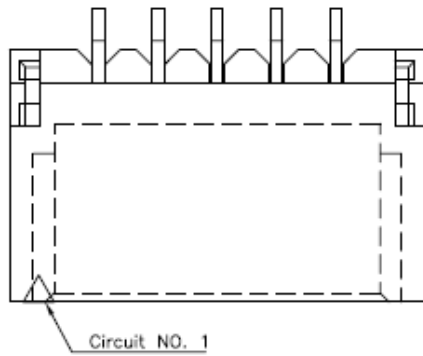

CKT	Dim A	Dim B	Dim C
5	4.0	5.4	7.0

