

# Interface RF Connector with Switch

## MS-151C Series

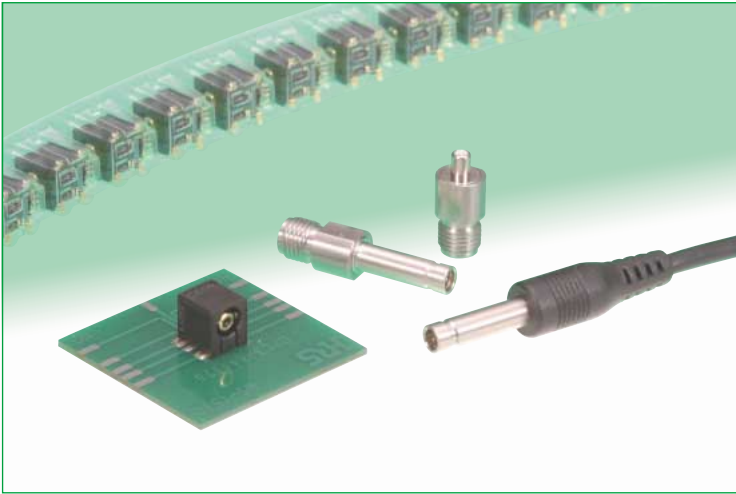

### Overview

Designed for end user applications requiring re-direction of the transmission.

Small size, lightweight and high reliability make it ideal for use in wireless applications requiring bandwidth of up to 6GHz.

### Features

#### 1. Confirmation of complete connection

Built-in interlock feature confirms fully mated condition with a "click" sensation.

#### 2. Non-directional connection

The connector can be mated in any position on a 360° axis and can rotate within the same when in use, allowing routing of the connected cable in any direction.

#### 3. High durability

Guaranteed 5000 insertion/removal cycles.

#### 4. Space-saving

The external dimensions of the board-mounted receptacle (7.3mm high, 7.9mm wide and 8.45mm deep) make it ideal for use in small devices.

#### 5. Ease of connection and handling

Over-molded plug, with convenient grip and built-in cable strain relief assures reliable mating/un-mating by the end user.

#### 6. Designed for board placement with automatic equipment

Top surface of receptacle assembly is flat, allowing reliable hold for vacuum nozzles of automatic placement equipment.

#### 7. RoHS compliant

All components and materials comply with EU Directive 2002/95/EC, with respect to all applicable substances.

### Applications

GPS terminals, wireless LAN modules, desktop and notebook computers, PDA's, high frequency equipment and other applications requiring re-direction of the transmission.

Plug can be rotated after full insertion.

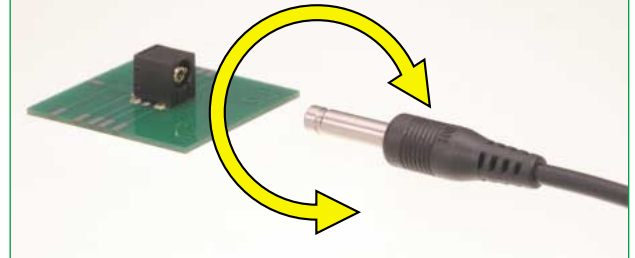

#### ●Receptacle

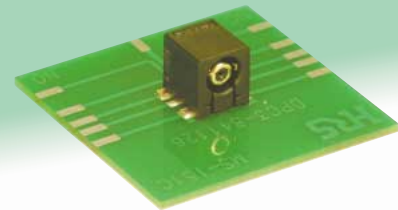

MS-151C

#### ●Plug



MS-151-C(BP)

#### ●SMA Conversion Adapter For Receptacle: MS-151C



MS151P-HRMJ-1

#### ●SMA Conversion Adapter For Plug: MS-151-C(BP)



MS151J-HRMJ

## ■Product Specifications

Frequency range	DC to 6GHz		
Operating temperature range	-40°C to +85°C		
Power rating	4W		
		Not mated with the plug	Open (Mated with MS-151-C(BP))
V.S.W.R.	DC to 2 GHz	1.2 max.	1.3 max.
	2 GHz to 4 GHz	1.3 max.	1.5 max.
	4 GHz to 5 GHz		1.7 max.
	5 GHz to 6 GHz	1.7 max.	
Insertion loss	DC to 2 GHz	0.4dB max.	0.4dB max.
	2 GHz to 4 GHz	0.5dB max.	0.6dB max.
	4 GHz to 5 GHz		0.8dB max.
	5 GHz to 6 GHz	1.0dB max.	
Isolation loss	DC to 2 GHz	————	18dB min.
	2 GHz to 4 GHz	————	14dB min.
	4 GHz to 6 GHz	————	12dB min.

Item	Specification	Conditions
1. Contact resistance	50 mΩ max.	100 mA
2. Insulation resistance	1000 MΩ min.	100 V DC
3. Withstanding voltage	No flashover or insulation breakdown	100 V AC / 1 minute
4. Vibration	No electrical discontinuity of 10 μs or more	Frequency : 10 to 500 Hz, single amplitude of 0.75 mm, 2 hours in each of the 3 directions
5. Shock	No electrical discontinuity of 10 μs or more	Acceleration of 490 m/s <sup>2</sup> , 6 ms duration, sine half-wave waveform, 3 cycles in each of the 3 axis
6. Temperature cycle	Contact resistance: 100 mΩ max. Insulation resistance: 10 MΩ min.	Temperature : -55°C → +5°C to +35°C → +85°C → +5°C to +35°C Time : 30 → 5 → 30 → 5 (Minutes) 100 cycles
7. Humidity (Steady state)	Contact resistance: 100 mΩ max. Insulation resistance: 10 MΩ min.	96 hours at 40°C, humidity of 90% to 95%
8. Salt spray	Contact resistance: 100 mΩ max. No excessive corrosions	5% salt water solution, 48 hours
9. Mating/un-mating forces	Mating : 1 to 10N Un-mating : 3 to 15N	With corresponding connector (Initial value)
10. Durability (insertion/ withdrawal)	Contact resistance: 100 mΩ max.	5000 cycles

## ■Materials

### Receptacle

Part	Material	Finish
Insulator	Polyamide (UL94V-0)	————
Lock mating section	Stainless steel	Gold plated
Outer conductor	Phosphor bronze	Gold plated
Contact A	Phosphor bronze	Gold plated
Contact C	Beryllium copper	Gold plated

### Plug

Part	Material	Finish
Ring	Stainless steel	Nickel plated
Outer conductor	Phosphor bronze	Nickel plated
Inner contact	Phosphor bronze	Gold plated
Insulator	PTFE	————
Ferrule	Phosphor bronze	————
Bushing	TPEE-M	————

## ◆ High Frequency Characteristics (Typical)

### ● NORMALLY CLOSED(N.C) ~ (Not mated with the plug)

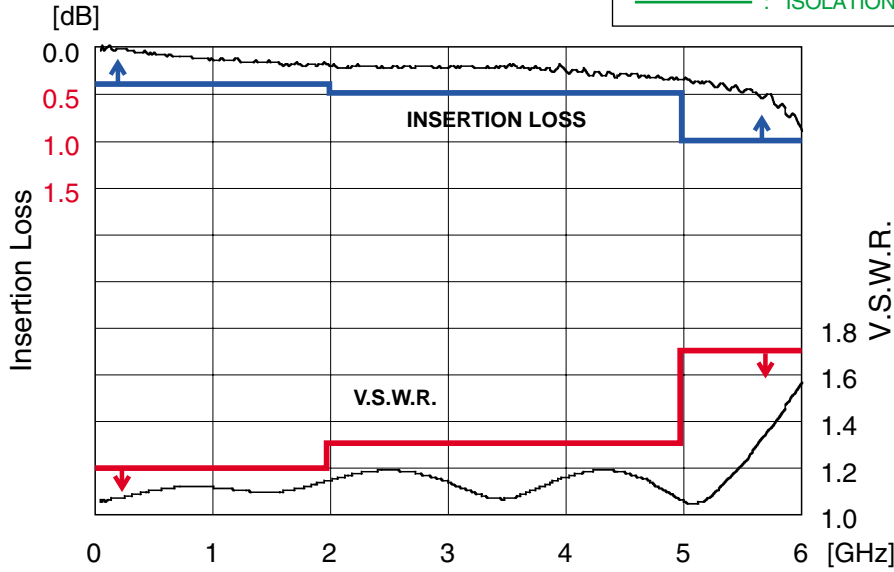
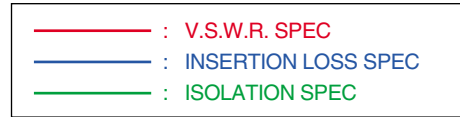

### ● OPEN(N.O) ~ (Mated with the plug)

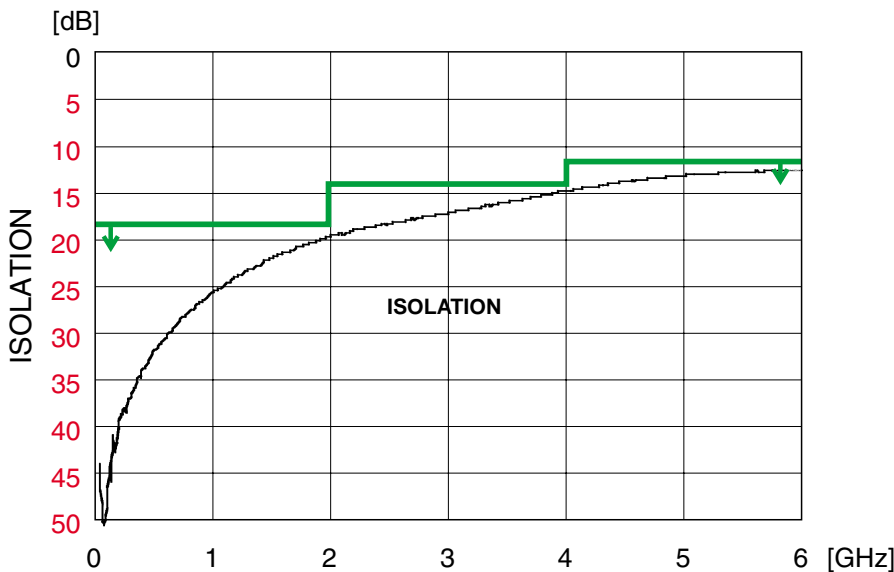
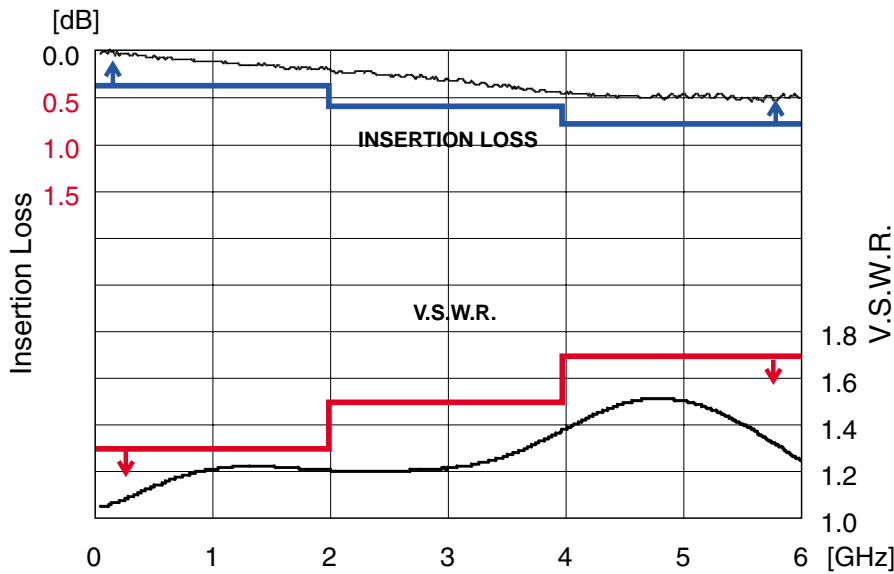

## ■ Receptacle

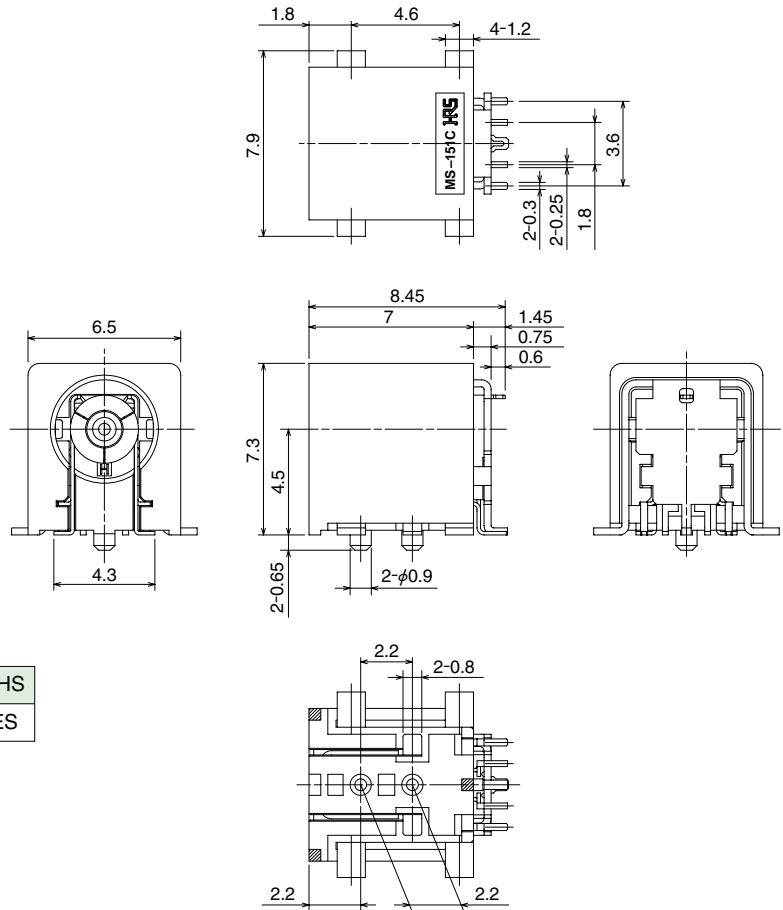
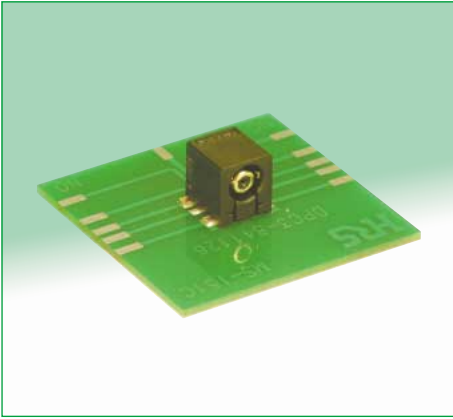

Part Number	CL No.	Packaging	RoHS
MS-151C	358-0211-8	800 pieces per reel	YES

## ◆ Circuit diagram

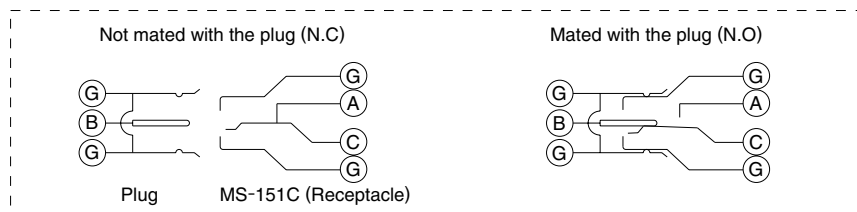

## ◆ PCB mounting pattern

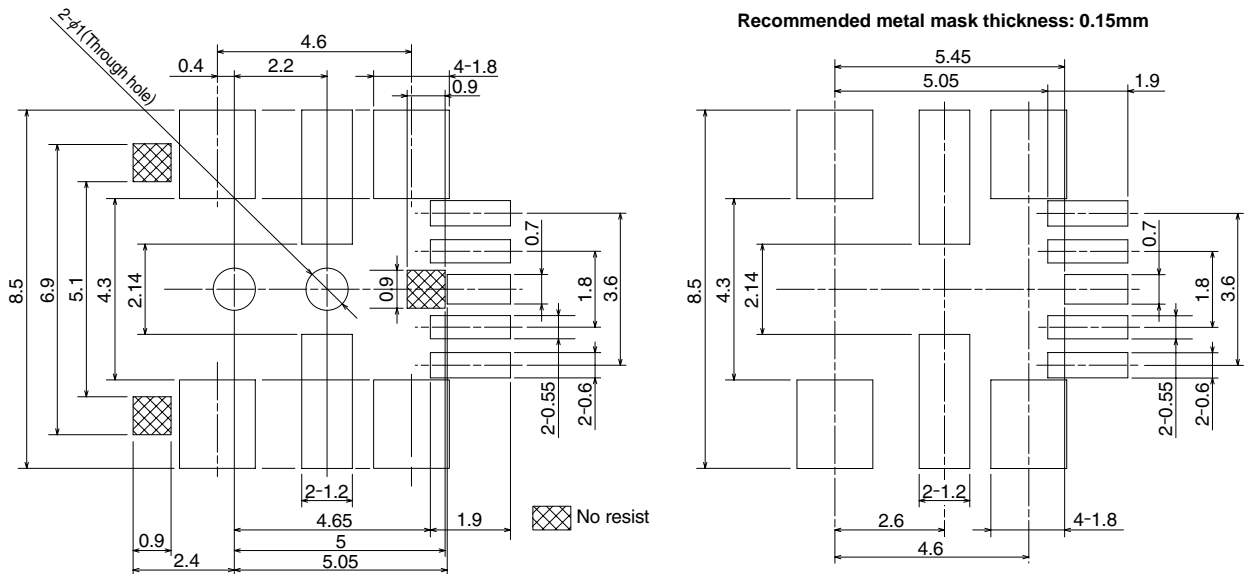

## ◆ Packaging Specifications

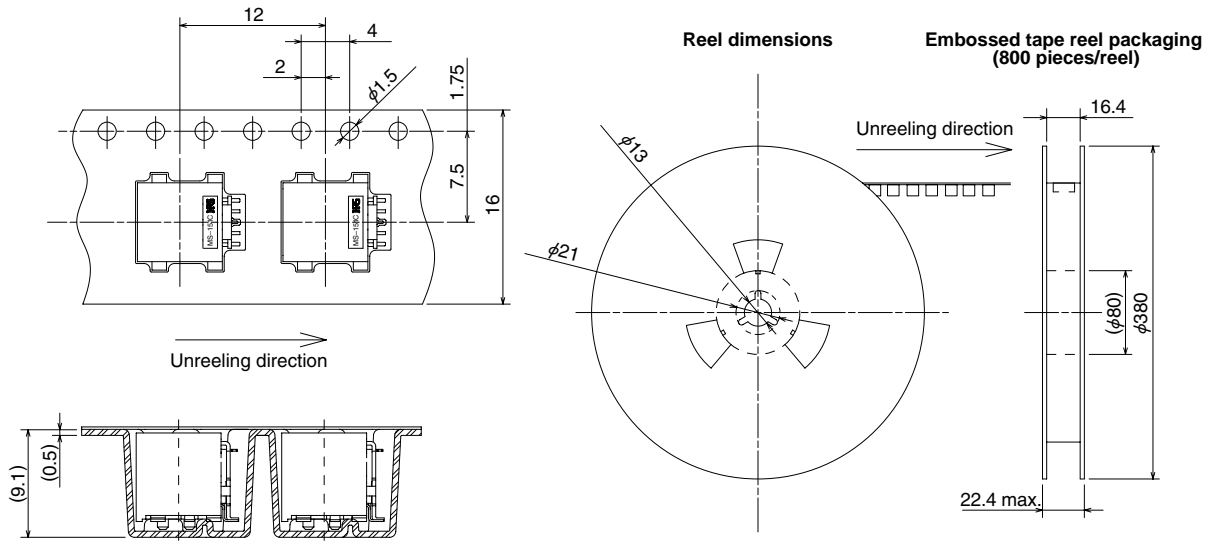

## ◆ Recommended Temperature Profile

### Lead-free Solder Paste

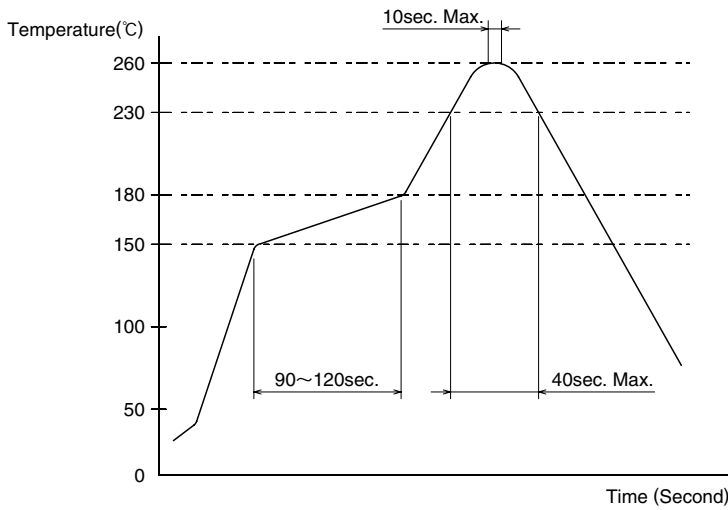

Maximum temperature	: 260°C
Duration of peak temperature	: 10 sec. max.
Peak temperature	: 240°C to 255°C
230°C min	: 40 sec. max.
150°C to 180°C	: 90 to 120 sec.

## ■ Plug

\* Supplied by HRS only as a terminated cable assembly.

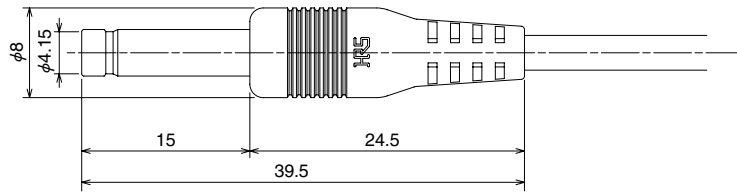

Part Number	CL No.	Applicable cable	Packaging	RoHS
MS-151-C(BP)	358-0219-0	1.5DS-QEHV(TA)	1	YES

## ■ SMA Conversion adapters

● For Receptacle: MS-151C

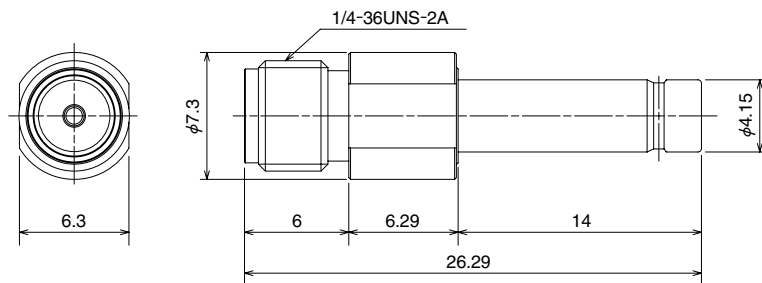

Part Number	CL No.	Packaging	RoHS
MS151P-HRMJ-1	355-0090-6	1	YES

● For Plug: MS-151-C(BP)

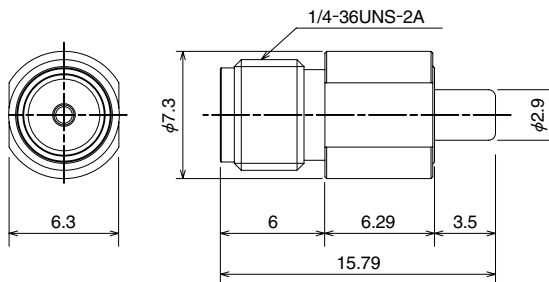

Part Number	CL No.	Packaging	RoHS
MS151J-HRMJ	355-0088-4	1	YES

## ■ Applications

### ● Wireless LAN IEEE802.11a/b/g

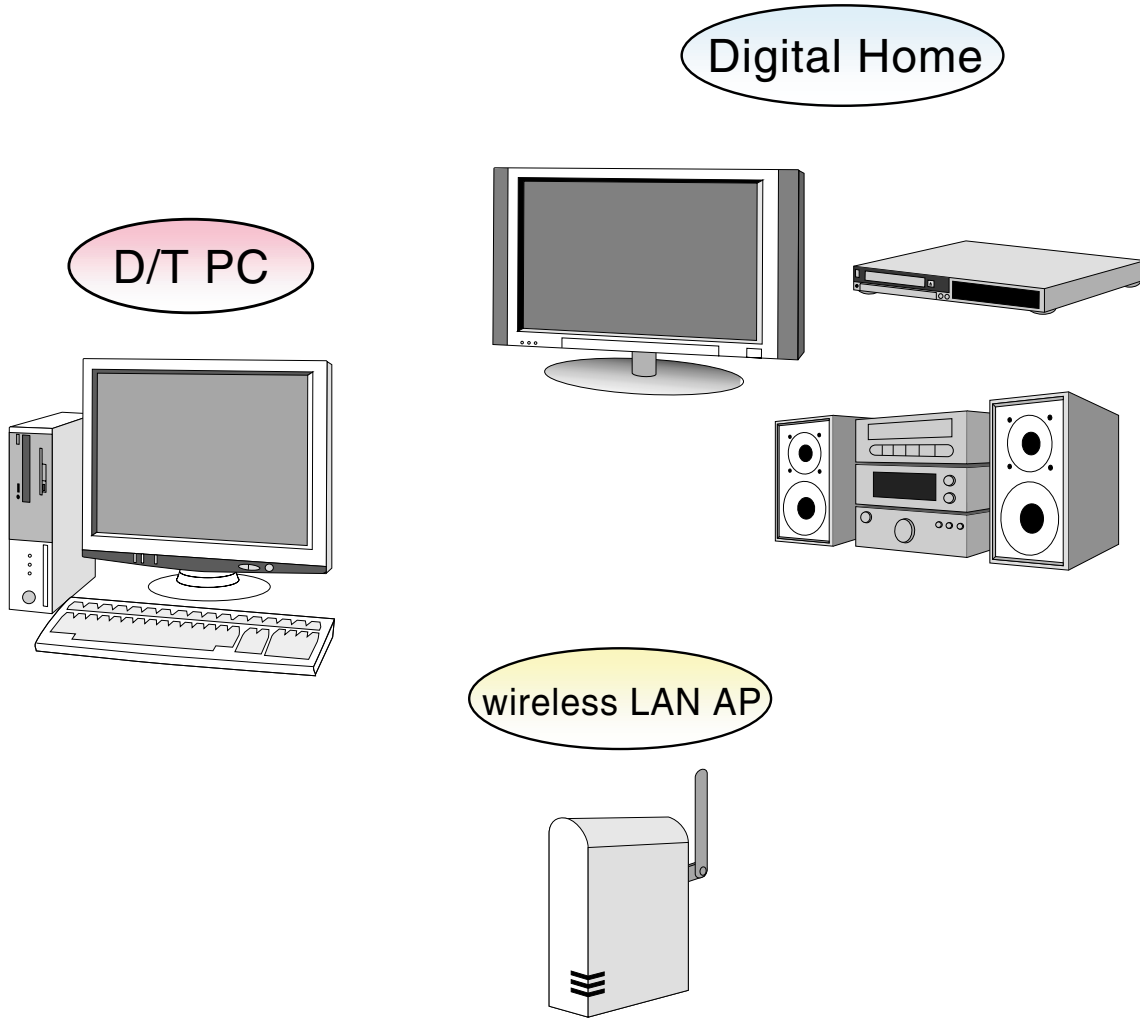

### ◆ Desktop PC with inner antenna for wireless LAN

