



The Future of Analog IC Technology®

MPQ8634A

16V, 12A, Sync, Step-Down Converter
with Adjustable Current Limit,
Programmable Frequency, and Voltage Tracking

DESCRIPTION

The MPQ8634A is a fully integrated, high-frequency, synchronous, buck converter. The MPQ8634A offers a very compact solution that achieves up to 12A output current with excellent load and line regulation over a wide input supply range. The MPQ8634A operates at high efficiency over a wide output current load range.

The MPQ8634A adopts an internally compensated constant-on-time (COT) control mode that provides fast transient response and eases loop stabilization.

The operating frequency can be set to 600kHz, 800kHz, or 1000kHz easily with MODE configuration, allowing the MPQ8634A frequency to remain constant regardless of the input/output voltages.

The output voltage start-up ramp is controlled by an internal 1.5ms timer. It can be increased by adding a capacitor on TRK/REF. An open-drain power good (PGOOD) signal indicates when the output is within its nominal voltage range. PGOOD is clamped at around 0.7V with an external pull-up voltage when the input supply fails to power the MPQ8634A.

Fully integrated protection features include over-current protection (OCP), over-voltage protection (OVP), under-voltage protection (UVP), and over-temperature protection (OTP).

The MPQ8634A requires a minimal number of readily available, standard, external components and is available in a QFN-21 (3mmx4mm) package.

FEATURES

- Wide Input Voltage Range:
 - 2.85V to 16V with External 3.3V VCC Bias
 - 4V to 16V with Internal VCC Bias or External 3.3V VCC Bias
- Differential Output Voltage Remote Sense
- Programmable Accurate Current Limit Level

- 12A Output Current
- Low $R_{DS(ON)}$ Integrated Power MOSFETs
- Proprietary Switching Loss Reduction Technique
- Adaptive COT for Ultrafast Transient Response
- Stable with Zero ESR Output Capacitor
- 0.5% Reference Voltage over 0°C to +70°C Junction Temperature Range
- 1% Reference Voltage from -40°C to +125°C Junction Temperature Range
- Pin-Selectable Pulse-Skip Mode or Forced CCM Operation
- Excellent Load Regulation
- Output Voltage Tracking
- Output Voltage Discharge
- PGOOD Actively Clamped at a Low Level during Power Failure
- Programmable Soft-Start Time from 1.5ms
- Pre-Bias Start-Up
- Selectable Switching Frequency from 600kHz, 800kHz, and 1000kHz
- Latch-Off OCP, UVP, UVLO, Thermal Shutdown, and Latch-Off for OVP
- Output Adjustable from 0.9V to 90%*VIN, up to 6V Max
- Available in a QFN-21 (3mmx4mm) Package

APPLICATIONS

- Telecom and Networking Systems
- Servers, Cloud-Computing, Storage
- Base Stations
- General Purpose Point-of-Load (PoL)
- 12V Distribution Power Systems
- High-end TV
- Game Consoles and Graphic Cards

All MPS parts are lead-free, halogen-free, and adhere to the RoHS directive. For MPS green status, please visit the MPS website under Quality Assurance. "MPS" and "The Future of Analog IC Technology" are registered trademarks of Monolithic Power Systems, Inc.

TYPICAL APPLICATION

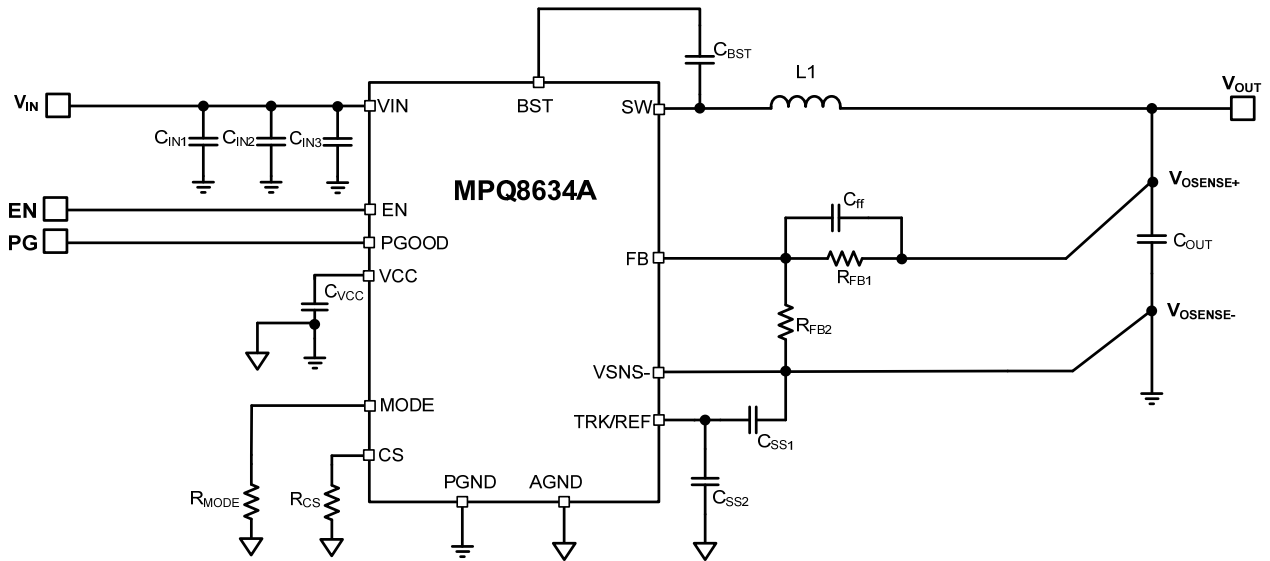



ORDERING INFORMATION

Part Number*	Package	Top Marking
MPQ8634AGLE	QFN-21 (3mmx4mm)	See Below

* For Tape & Reel, add suffix –Z (e.g. MPQ8634AGLE–Z)

TOP MARKING

MPYW

8634

ALLL

E

MP: MPS prefix
Y: Year code
W: Week code
8634A: First five digits of the part number
LLL: Lot number
E: MPQ8634AGLE

PACKAGE REFERENCE

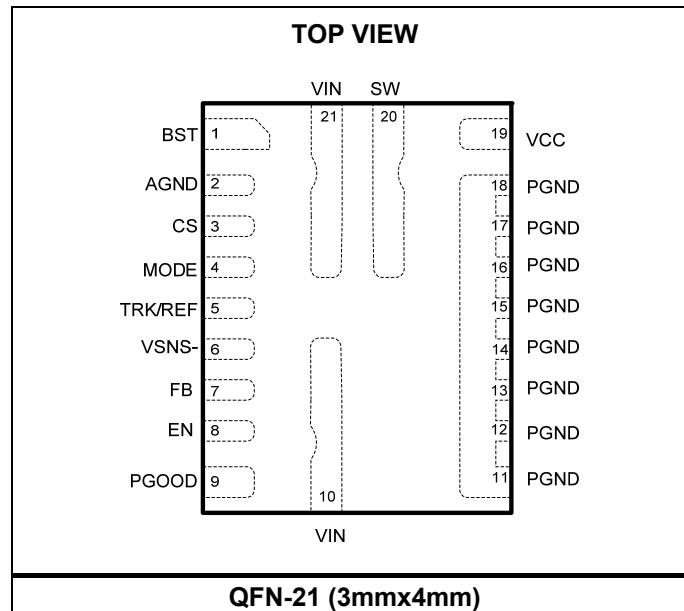



Absolute Maximum Ratings ⁽¹⁾

Supply voltage (VIN)	18V
V _{SW} (DC)	-0.3V to VIN + 0.3V
V _{SW} (25ns) ⁽²⁾	-3V to 25V
V _{SW} (25ns)	-5V to 25V
V _{BST}	V _{SW} + 4V
VCC, EN	4.5V
All other pins	-0.3V to 4.3V
Junction temperature	170°C
Lead temperature	260°C
Storage temperature	-65°C to +170°C

Recommended Operating Conditions ⁽³⁾

Supply voltage (VIN)	4V to 16V
V _{IN} (DC) - V _{SW} (DC) ⁽⁴⁾	-0.3V to VIN + 0.3V
V _{SW} (DC) ⁽⁴⁾	-0.3V to VIN + 0.3V
Output voltage (V _{OUT})	0.9V to 6V
External VCC bias (V _{CC_EXT})	3.12V to 3.6V
Maximum output current (I _{OUT_MAX})	12A
Maximum output current limit (I _{OC_MAX})	16A
Maximum peak inductor current (I _{L_PEAK})	18A
EN voltage (V _{EN})	3.6V
Operating junction temp. (T _J)	-40°C to +125°C

Thermal Resistance ⁽⁵⁾	θ_{JB}	θ_{JC_TOP}	
QFN-21 (3mmx4mm)	9	21	°C/W

NOTES:

- 1) Exceeding these ratings may damage the device.
- 2) Measured by using differential oscilloscope probe.
- 3) The device is not guaranteed to function outside of its operating conditions.
- 4) The voltage rating can be in the range of -3V to 23V for a period of 25ns or less with a maximum repetition rate of 1000kHz when the input voltage is 16V.
- 5) θ_{JB} : Thermal resistance from the junction to the board around the PGND soldering point.
 θ_{JC_TOP} : Thermal resistance from the junction to the top of the package.



ELECTRICAL CHARACTERISTICS

VIN = 12V, TJ = -40°C to +125°C, unless otherwise noted.

Parameters	Symbol	Condition	Min	Typ	Max	Units
Supply Current						
Supply current (shutdown)	I _{IN}	V _{EN} = 0V		0	10	μA
Supply current (quiescent)	I _{IN}	V _{EN} = 2V, V _{FB} = 1V		650	850	μA
MOSFET						
Switch leakage	SW _{LKG_HS}	V _{EN} = 0V, V _{SW} = 0V		0	10	μA
	SW _{LKG_LS}	V _{EN} = 0V, V _{SW} = 12V		0	30	
HS on-state resistance	R _{DS_ON_HS}	V _{EN} = 2V @ 25°C		13.3		mΩ
LS on-state resistance	R _{DS_ON_LS}	V _{EN} = 2V @ 25°C		3.8		mΩ
Current Limit						
Current limit threshold	V _{LIM}		1.15	1.2	1.25	V
I _{CS} to I _{OUT} ratio	I _{CS} /I _{OUT}	I _{OUT} ≥ 2A	18	20	22	μA/A
Low-side negative current limit	I _{LIM_NEG}			-9		A
Negative current limit timeout ⁽⁶⁾	t _{NCL_Timer}			200		ns
Switching Frequency						
Switching frequency ⁽⁷⁾	f _{SW}	MODE = GND, I _{OUT} = 0A, V _{OUT} = 1V	480	600	720	kHZ
		MODE = 30.1kΩ, I _{OUT} = 0A, V _{OUT} = 1V	680	800	920	kHZ
		MODE = 60.4kΩ, I _{OUT} = 0A, V _{OUT} = 1V	850	1000	1150	kHZ
Minimum on time ⁽⁶⁾	T _{ON_MIN}				50	ns
Minimum off time ⁽⁶⁾	T _{OFF_MIN}	V _{FB} = 800mV			180	ns
Over-Voltage (OVP) and Under-Voltage Protection (UVP)						
OVP threshold	V _{OVP}		113%	116%	119%	V _{REF}
UVP threshold	V _{UVP}		77%	80%	83%	V _{REF}
Feedback Voltage and Soft Start (SS)						
Feedback voltage	V _{REF}	T _J = -40°C to +125°C	891	900	909	mV
		T _J = 0°C to +70°C	895	900	905	mV
TRK/REF sourcing current	I _{TRACK_Source}	V _{TRK/REF} = 0V		42		μA
TRK/REF sinking current	I _{TRACK_Sink}	V _{TRK/REF} = 1V		12		μA
Soft-start time	t _{SS}	C _{SS} = 1nF	1	1.5		ms
Error Amplifier (EA)						
Error amplifier offset	V _{OS}		-3	0	3	mV
Feedback current	I _{FB}	V _{FB} = REF		50	100	nA
Enable (EN) and Under-Voltage Lockout (UVLO)						
Enable input rising threshold	V _{IHEN}		1.17	1.22	1.27	V
Enable hysteresis	V _{EN-HYS}			200		mV
Enable input current	I _{EN}	V _{EN} = 2V		0		μA
Soft shutdown discharge MOSFET	R _{ON_DISCH}			80	150	Ω



ELECTRICAL CHARACTERISTICS (continued)

VIN = 12V, TJ = -40°C to +125°C, unless otherwise noted.

Parameters	Symbol	Condition	Min	Typ	Max	Units
VIN UVLO						
VIN under-voltage lockout threshold rising	VIN _{Vth-Rise}	VCC = 3.3V	2.1	2.4	2.7	V
VIN under-voltage lockout threshold falling	VIN _{Vth-Fall}		1.55	1.85	2.15	V
VCC Regulator						
VCC under-voltage lockout threshold rising	VCC _{Vth_Rise}		2.65	2.8	2.95	V
VCC under-voltage lockout threshold falling	VCC _{Vth_Fall}		2.35	2.5	2.65	V
VCC regulator	VCC		2.88	3.00	3.12	V
VCC load regulation		I _{CC} = 25mA		0.5		%
Power Good (PGOOD)						
Power good high threshold	PG _{Vth_Hi_Rise}	FB from low to high	89%	92.5%	95%	V _{REF}
Power good low threshold	PG _{Vth_Lo_Rise}	FB from low to high	113%	116%	119%	V _{REF}
	PG _{Vth_Lo_Fall}	FB from high to low	77%	80%	83%	V _{REF}
Power good low to high delay	PG _{Td}	T _J = +25°C	0.63	0.9	1.17	ms
Power good sink current capability	V _{PG}	I _{PG} = 10mA			0.5	V
Power good leakage current	I _{PG_LEAK}	V _{PG} = 3.3V			3	μA
Power good low-level output voltage	V _{OL_100}	VIN = 0V, pull PGOOD up to 3.3V through a 100kΩ resistor @ 25°C		650	800	mV
	V _{OL_10}	VIN = 0V, pull PGOOD up to 3.3V through a 10kΩ resistor @ 25°C		750	900	mV
Thermal Protection						
Thermal shutdown ⁽⁶⁾	T _{SD}		150	160		°C

NOTES:

- 6) Guaranteed by design.
- 7) Guaranteed by design over temperature.



TYPICAL PERFORMANCE CHARACTERISTICS

V_{IN} = 12V, T_A = 25°C, V_{OUT} = 1.2V, F_S = 800kHz unless otherwise noted.

Efficiency
Pulse Skip, 1.1uH, 800kHz

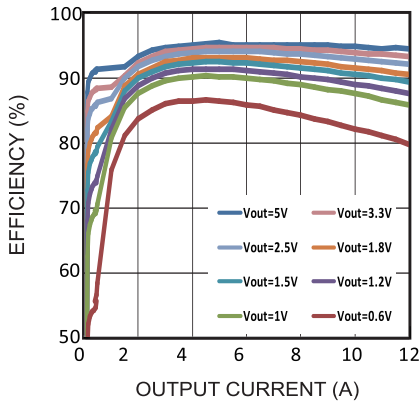

Efficiency
Forced CCM, 1.1uH, 800kHz

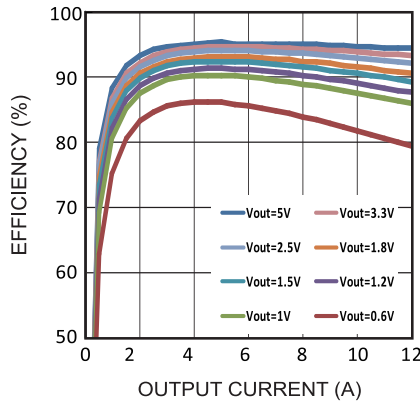

Thermal Results
800kHz, No Air-Flow

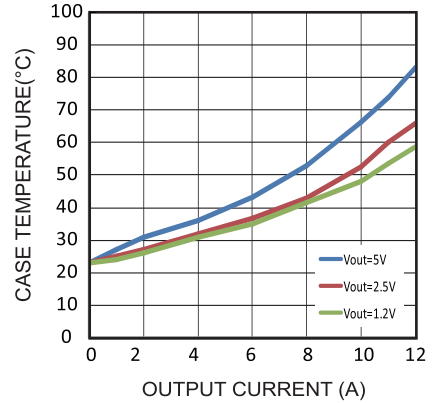

Switching Frequency vs. Output Current
Forced CCM

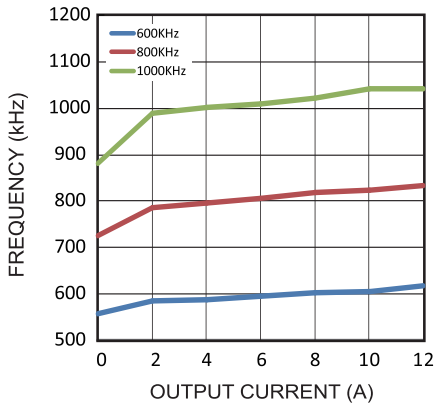

Output Voltage Load Regulation

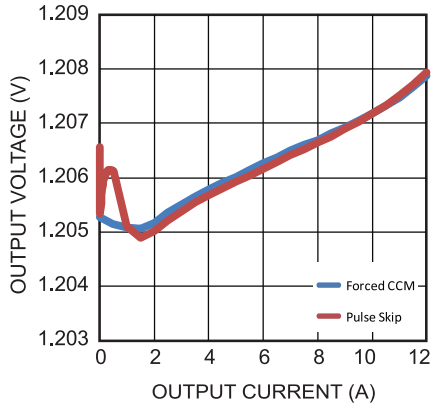

Thermal Derating
V_{IN}=12V, f_S=800kHz, T_J=125°C, No Air-Flow

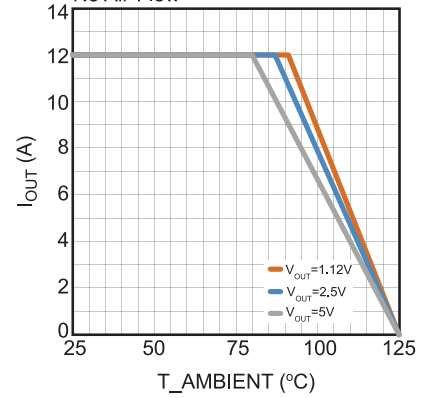

Switching Frequency vs. Input Voltage
V_{OUT}=1.2V, 3A Load

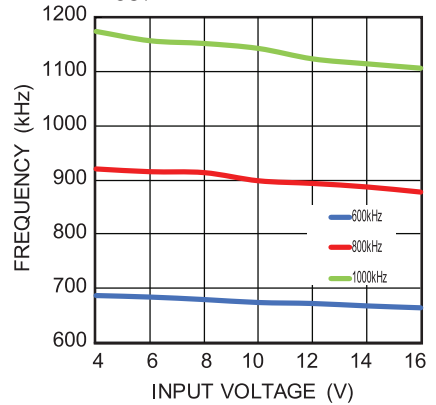

Switching Frequency vs. Output Voltage
V_{IN}=12V, 3A Load

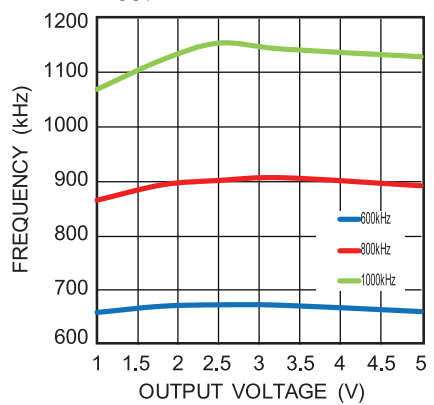

TYPICAL PERFORMANCE CHARACTERISTICS (continued)

VIN = 12V, TA = 25°C, VOUT = 1.2V, FS = 800kHz unless otherwise noted.

Steady State

IOUT = 0A, Pulse Skip

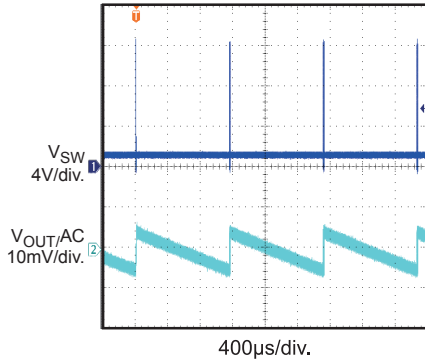

Steady State

IOUT = 0.5A, Pulse Skip

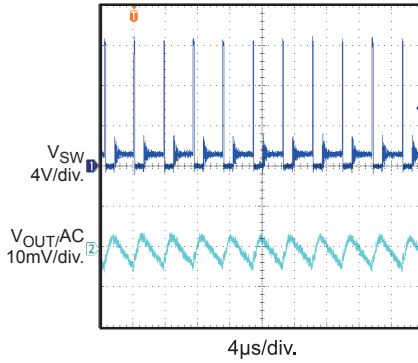

Steady State

IOUT = 12A, Pulse Skip

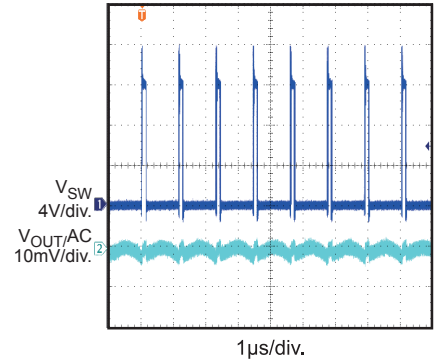

Steady State

IOUT = 0A, Forced CCM

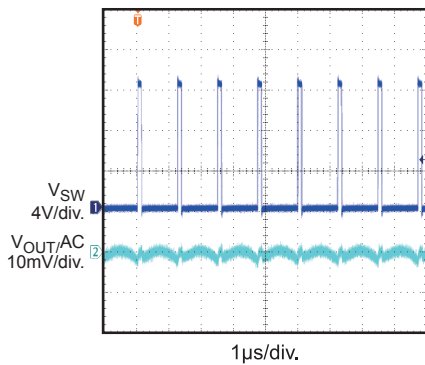

Steady State

IOUT = 12A, Forced CCM

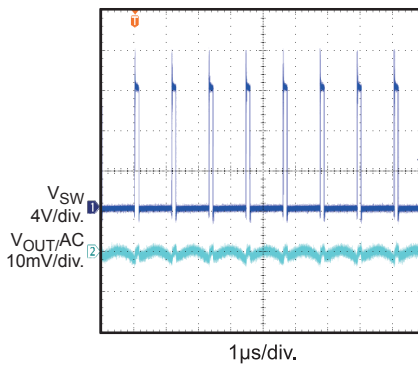

Load Transient

IOUT = 0A-6A, Pulse Skip

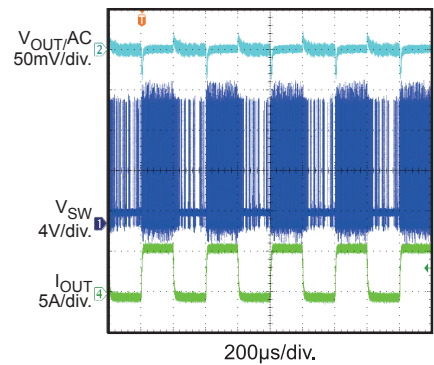

Load Transient

IOUT = 0A-6A, Forced CCM

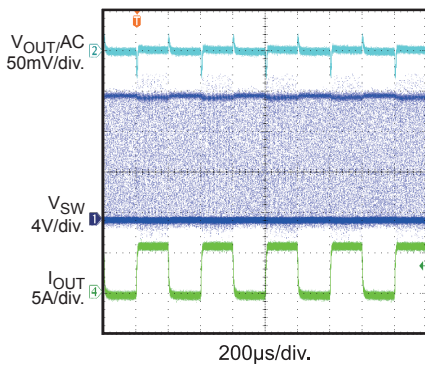

Power Up through EN

IOUT = 0A, Pulse Skip

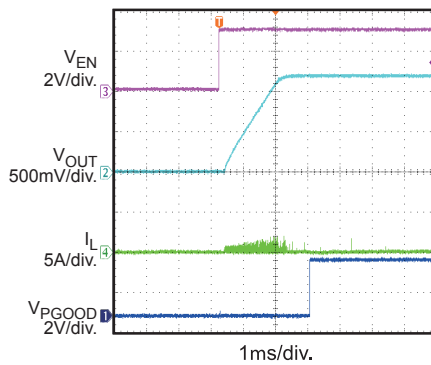

Power Up through EN

IOUT = 12A, Pulse Skip

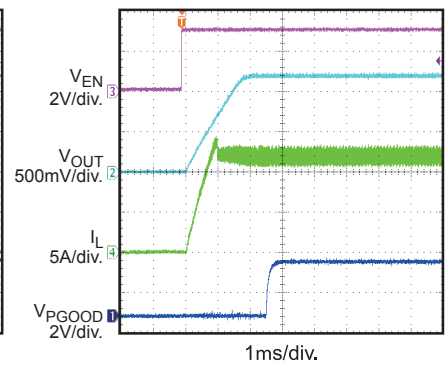

TYPICAL PERFORMANCE CHARACTERISTICS (continued)

VIN = 12V, TA = 25°C, VOUT = 1.2V, FS = 800kHz unless otherwise noted.

Power Up through EN

IOUT = 0A, Forced CCM

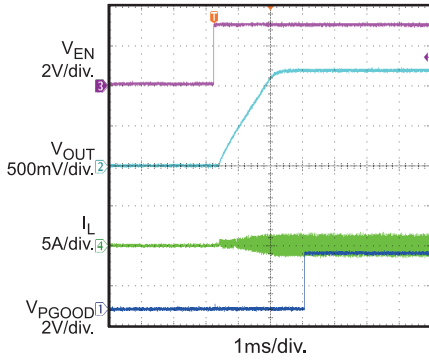

Power Up through EN

IOUT = 12A, Forced CCM

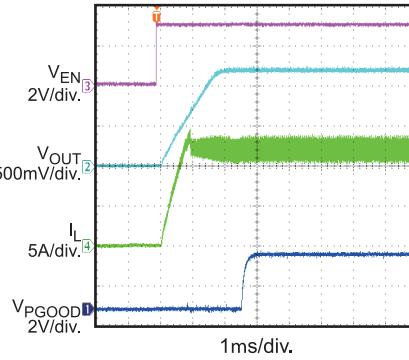

Power Down through EN

IOUT = 0A, Pulse Skip

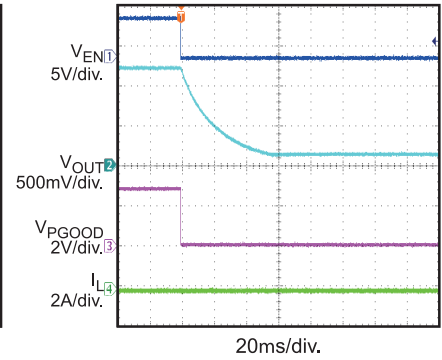

Power Down through EN

IOUT = 12A, Pulse Skip

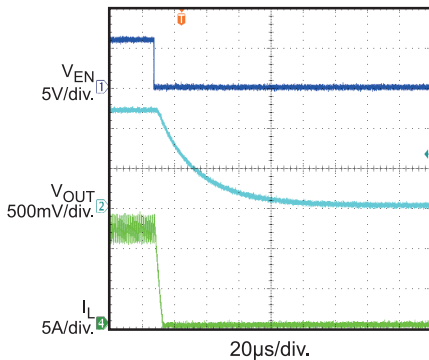

Power Down through EN

IOUT = 0A, Forced CCM

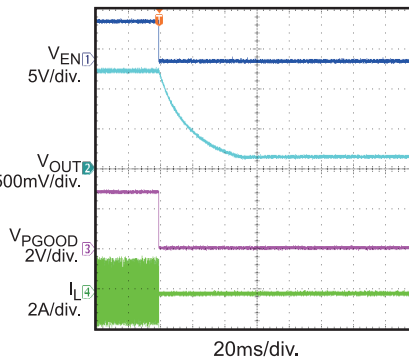

Power Down through EN

IOUT = 12A, Forced CCM

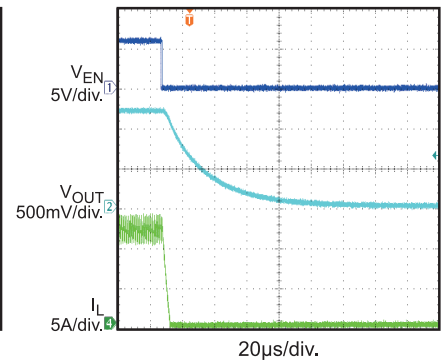

Pre-Bias Start-Up

Pulse Skip

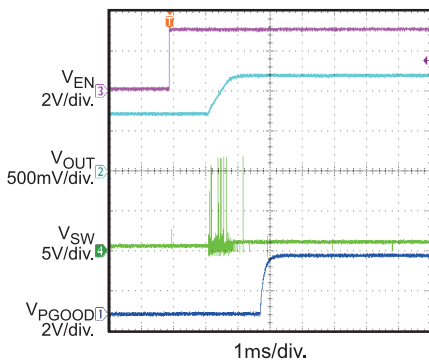

Pre-Bias Start-Up

Forced CCM

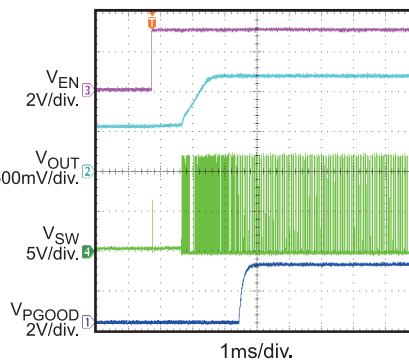

Over-Current Protection Entry

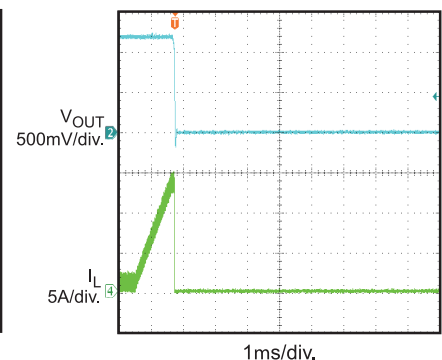

TYPICAL PERFORMANCE CHARACTERISTICS *(continued)*

VIN = 12V, TA = 25°C, VOUT = 1.2V, FS = 800kHz unless otherwise noted.

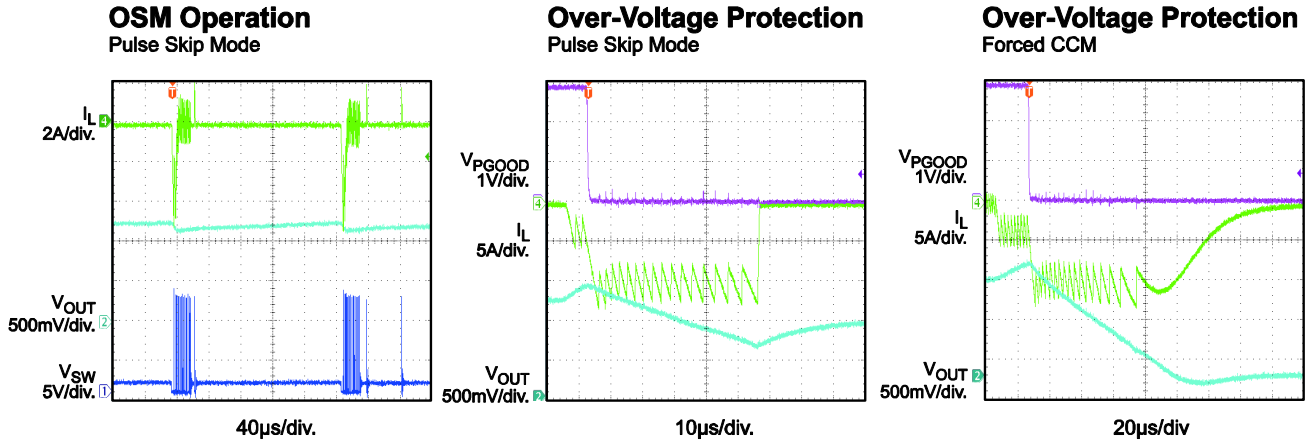



PIN FUNCTIONS

PIN #	Name	Description
1	BST	Bootstrap. Connect a capacitor between SW and BS to form a floating supply across the high-side switch driver.
2	AGND	Analog ground. Select AGND as the control circuit reference point.
3	CS	Current limit. Connect a resistor to ground to set the current limit trip point. See Equation 4 for additional details.
4	MODE	Operation mode selection. Program MODE to select continuous conduction mode (CCM), pulse-skip mode, and the operating switching frequency (See Table 1 for additional details.).
5	TRK/REF	External tracking voltage input. The output voltage tracks this input signal. Decouple TRK/REF with a ceramic capacitor as close to TRK/REF as possible. X7R or X5R grade dielectric ceramic capacitors are recommended for their stable temperature characteristics. The capacitance of this capacitor determines the soft-start time (See Equation 2 and 3 for additional details.).
6	VSNS-	Differential remote sense negative input. Connect VSNS- to the negative side of the voltage sense point directly. Short VSNS- to AGND if the remote sense is not being used.
7	FB	Feedback (differential remote sense positive input). An external resistor divider from the output to VSNS- tapped to FB sets the output voltage. Place the resistor divider as close to FB as possible. Vias should be avoided on the FB traces.
8	EN	Enable. EN is an input signal that turns the regulator on or off. Drive EN high to turn on the regulator; drive EN low to turn off the regulator. Connect EN to VIN through a pull-up resistor or a resistive voltage divider for automatic start-up. Do not float EN.
9	PGOOD	Power good output. PGOOD is an open-drain signal. A pull-up resistor connected to a DC voltage is required to indicate high if the output voltage is within regulation. There is ~1ms of delay from FB \geq 92.5% to when PGOOD is asserted.
10, 21	VIN	Input voltage. VIN supplies power for the internal MOSFET and regulator. Input capacitors are needed to decouple the input rail. Make the connection using wide PCB traces.
11-18	PGND	System ground. PGND is the reference ground of the regulated output voltage and requires careful consideration during PCB layout. Make the connection using wide PCB traces.
19	VCC	Internal 3V LDO output. The driver and control circuits are powered from VCC. Decouple VCC with a minimum 1 μ F ceramic capacitor as close to VCC as possible. X7R or X5R grade dielectric ceramic capacitors are recommended for their stable temperature characteristics.
20	SW	Switch output. Connect SW to the inductor and bootstrap capacitor. SW is driven up to VIN by the high-side switch during the on-time of the PWM duty cycle. The inductor current drives SW low during the off-time. Make the connection using wide PCB traces.

BLOCK DIAGRAM

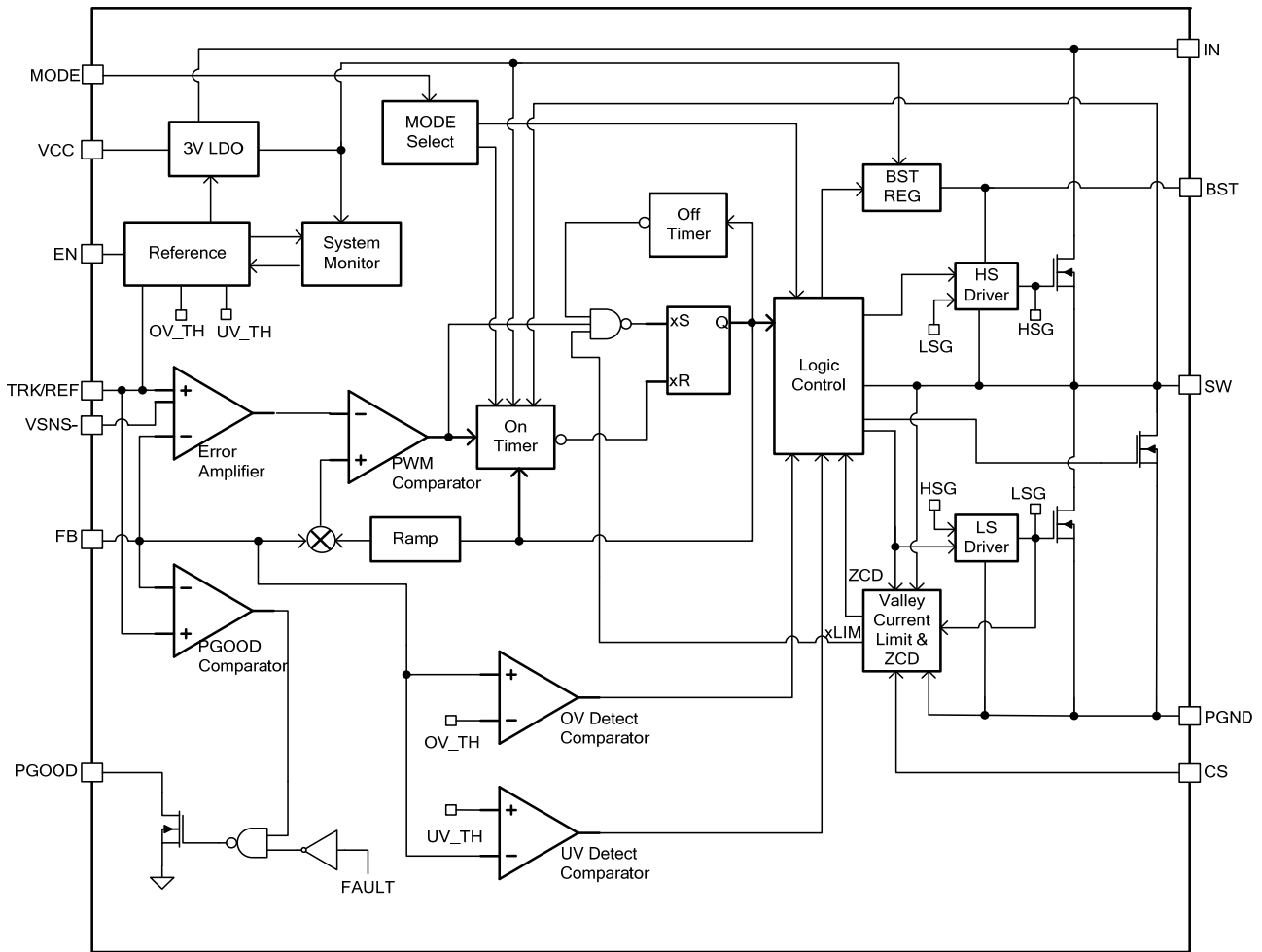

Figure 1: Functional Block Diagram

OPERATION

Constant-On-Time (COT) Control

The MPQ8634A employs constant-on-time (COT) control to achieve a fast load transient response (see Figure 2).

The operational amplifier (AMP) corrects any error voltage between FB and the reference voltage (V_{REF}). The MPQ8634A can use AMP to provide excellent load regulation over the entire load range, no matter if the device is operating in forced continuous conduction mode (CCM) or pulse-skip mode.

The dedicated VSNS- pin helps provide differential output voltage remote sensing. The pair of the remote sense trace should be kept at a low impedance to achieve the best performance.

The MPQ8634A has an internal ramp compensation that supports a low ESR MLCC output capacitor solution. The adaptive internal ramp is optimized so that the MPQ8634A is stable in the entire operating input/output voltage range with the proper design of the output L/C filter.

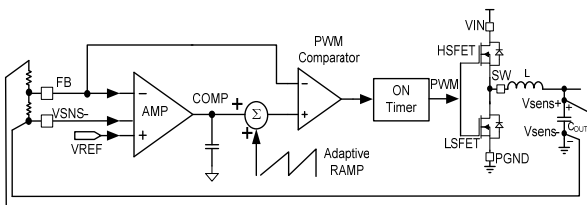

Figure 2: COT Control

Pulse-Width Modulation (PWM) Operation

Figure 3 shows how the pulse-width modulation (PWM) is generated. AMP corrects any error between FB and REF and generates a fairly smooth DC voltage (COMP). The internal ramp is superimposed onto COMP, which is compared with the FB signal. Whenever FB drops below the superimposed COMP, the integrated high-side MOSFET (HS-FET) is turned on. The HS-FET remains on for a fixed turn-on time. The fixed on time is determined by the input voltage, output voltage, and selected switching frequency. After the on period elapses, the HS-FET turns off and turns on again when FB drops below the superimposed

COMP. By repeating this operation, the MPQ8634A regulates the output voltage.

The integrated low-side MOSFET (LS-FET) turns on when the HS-FET is in its off state to minimize conduction loss. A dead short occurs between VIN and PGND if both the HS-FET and the LS-FET are turned on at the same time. This is called a shoot-through. To prevent shoot-through, a dead time (DT) is generated internally between the HS-FET off and the LS-FET on period or the LS-FET off and the HS-FET on period.

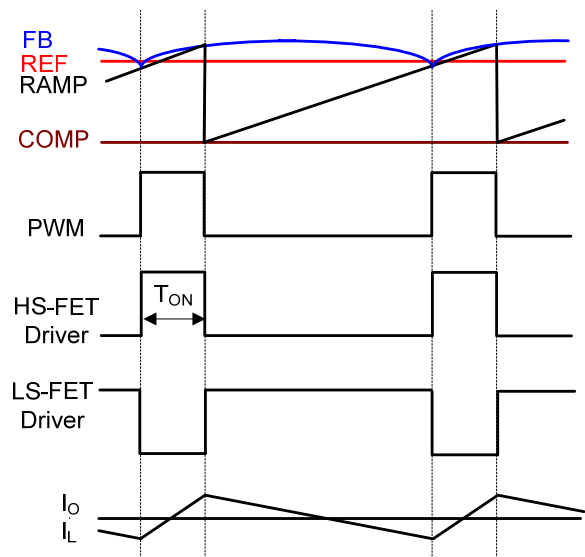

Figure 3: Heavy-Load Operation (PWM)

Continuous Conduction Mode (CCM)

Continuous conduction mode (CCM) occurs when the output current is high and the inductor current is always above zero amps (see Figure 2). The MPQ8634A can also be configured to operate in forced CCM operation when the output current is low (see the MODE Selection section on page 14 for details).

In CCM operation, the switching frequency is fairly constant (PWM mode), and the output ripple remains almost the same throughout the entire load range.

Pulse-Skip Operation

In light-load condition, the MPQ8634A can be configured to work in pulse-skip mode to optimize efficiency. When the load decreases, the inductor current decreases as well. Once the inductor current reaches zero, the part

transitions from CCM to pulse-skip mode if the MPQ8634A is configured so (see the MODE Selection section on page 14 for details).

Figure 4 shows pulse-skip mode operation in light-load condition. When FB drops below the superimposed COMP, the HS-FET turns on for a fixed interval. When the HS-FET turns off, the LS-FET turns on until the inductor current reaches zero. In pulse-skip mode operation, FB does not reach the superimposed COMP when the inductor current approaches zero. The LS-FET driver turns into tri-state (Hi-Z) when the inductor current reaches zero. A current modulator takes over the control of the LS-FET and limits the inductor current to less than -1mA. The output capacitors discharge slowly to PGND through the LS-FET. In light-load condition, the HS-FET is not turned on as frequently in pulse-skip mode as it is in forced CCM. As a result, the efficiency in pulse-skip mode is improved greatly compared with that in forced CCM operation.

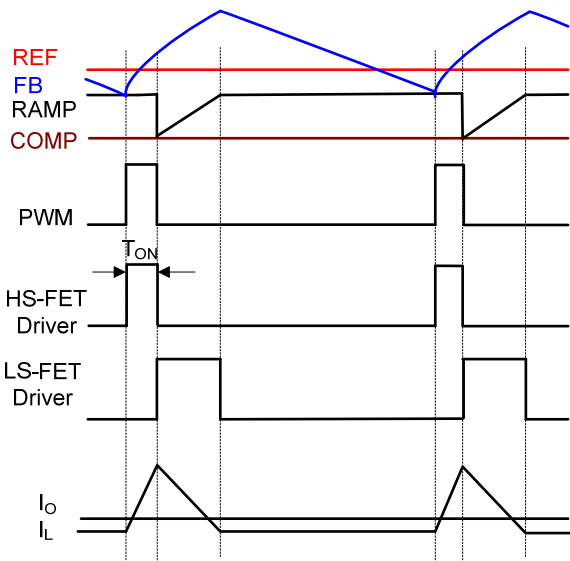

Figure 4: Pulse Skip at Light Load

As the output current increases from the light-load condition, the current modulator regulation time period becomes shorter. The HS-FET is turned on more frequently, and the switching frequency increases accordingly. The output current reaches the critical level when the current modulator time is zero. The critical level of the output current is determined with Equation (1):

$$I_{OUT} = \frac{(V_{IN} - V_{OUT}) \times V_{OUT}}{2 \times L \times F_{SW} \times V_{IN}} \quad (1)$$

Where F_{SW} is the switching frequency.

The part enters PWM mode once the output current exceeds the critical level. Afterward, the switching frequency remains fairly constant over the output current range.

The MPQ8634A can be configured to operate in forced CCM, even if in a light-load condition (see Table 1).

MODE Selection

The MPQ8634A provides both forced CCM operation and pulse-skip mode operation in light-load condition. The MPQ8634A has three options for switching frequency selection: 600kHz, 800kHz, and 1000kHz. Select the operation mode under light-load condition and the switching frequency by choosing the resistance value of the resistor connected between MODE and AGND or VCC (see Table 1).

Table 1: MODE Selection

MODE	Light-Load Mode	Switching Frequency
VCC	Pulse skip	600kHz
243kΩ (±20%) to AGND	Pulse skip	800kHz
121kΩ (±20%) to AGND	Pulse skip	1000kHz
GND	Forced CCM	600kHz
30.1kΩ (±20%) to AGND	Forced CCM	800kHz
60.4kΩ (±20%) to AGND	Forced CCM	1000kHz

Soft Start (SS)

The minimum soft-start time is limited at 1.5ms. This time can be increased by adding a SS capacitor between TRK/REF and VSNS-.

The total SS capacitor value can be determined with Equation (2) and Equation (3):

$$C_{SS}(\text{nF}) = \frac{t_{SS}(\text{ms}) \times 36(\mu\text{A})}{0.9(\text{V})} \quad (2)$$

$$C_{SS} = C_{SS1} + C_{SS2} \quad (3)$$

Where C_{SS2} is recommended to be minimum of 22nF.

Output Voltage Tracking and Reference

The MPQ8634A provides an analog input pin (TRK/REF) to track another power supply or accept an external reference. When an external voltage signal is connected to TRK/REF, it acts as a reference for the MPQ8634A output voltage. The FB voltage (V_{FB}) follows this external voltage signal exactly. The soft-start settings are ignored. The TRK/REF input signal can be in the range of 0.3V to 1.4V. During the initial start-up, TRK/REF must be at least 900mV to ensure proper operation. Afterward, it can be any value between 0.3V and 1.4V.

Pre-Bias Start-Up

The MPQ8634A has been designed for monotonic start-up into pre-biased loads. If the output is pre-biased to a certain voltage during start-up, the IC disables switching for both the HS-FET and LS-FET until the voltage on the TRK/REF capacitor exceeds the sensed output voltage at FB. Before the TRK/REF voltage reaches the pre-biased FB level, if the BST voltage (from BST to SW) is lower than 2.3V, the LS-FET is turned on to allow the BST voltage to be charged through VCC. The LS-FET is turned on for very narrow pulses, so the drop in the pre-biased level is negligible.

Output Voltage Discharge

When the MPQ8634A is disabled through EN, it enables the output voltage discharge mode. This causes both the HS-FET and the LS-FET to latch off. A discharge MOSFET connected between SW and PGND is turned on to discharge the output voltage. The typical switch on resistance of this MOSFET is about 80Ω. Once V_{FB} drops below 10%*REF, the discharge MOSFET is turned off.

Current Sense and Over-Current Protection (OCP)

The MPQ8634A features an on-die current sense and a programmable positive current limit threshold. The current limit is active when the MPQ8634A is enabled. During the LS-FET on state, the SW current (inductor current) is sensed and mirrored to CS with the ratio of G_{CS} . By using a resistor (R_{CS}) from CS to AGND, the

CS voltage (V_{CS}) is proportional to the SW current cycle-by-cycle.

The HS-FET is only allowed to turn on when V_{CS} is below the internal over-current protection (OCP) voltage threshold (V_{OCP}) (during the LS-FET on state) to limit the SW valley current cycle-by-cycle.

Calculate the current limit threshold setting from R_{CS} with Equation (4):

$$R_{CS}(\Omega) = \frac{V_{OCP}}{G_{CS} \times (I_{LIM} - \frac{(V_{IN} - V_O) \times V_O \times 1}{V_{IN} \times 2 \times L \times f_s})} \quad (4)$$

Where V_{OCP} is 1.2V, G_{CS} is 20μA/A, and I_{LIM} is the desired output current limit (A).

After SS finishes, the MPQ8634A latches off if it detects an over-current condition for 31 consecutive cycles, or if FB drops below the under-voltage protection (UVP) threshold. The MPQ8634A is enabled by recycling the power of VCC or EN.

Negative Inductor Current Limit

When the LS-FET detects a -9A current, the part turns off the LS-FET for 200ns to limit the negative current. After 200ns, the LS-FET is turned on again.

Output Sinking Mode (OSM)

The MPQ8634A employs output sinking mode (OSM) to regulate the output voltage to the targeted value. When V_{FB} is higher than 105%*REF but is lower than the OVP threshold, OSM is triggered. During OSM operation, the LS-FET remains on until it reaches the -6.5A negative current limit. The LS-FET is momentarily turned off for 200ns and is then turned on again. The MPQ8634A maintains this operation until V_{FB} drops below 102%*REF. Then the MPQ8634A exits OSM after 15 consecutive cycles of forced CCM.

Over-Voltage Protection (OVP)

The MPQ8634A monitors the output voltage by connecting FB to the tap of the output voltage feedback resistor divider to detect an over-voltage condition. This provides latch-off over-voltage protection (OVP) mode.

If V_{FB} exceeds 116% of V_{REF} , the device enters latch-off OVP mode. The HS-FET latches off and PGOOD latches low until the power of VCC or EN is recycled. Meanwhile, the LS-FET remains on until it reaches the low-side negative current limit (NOCP). Once it hits NOCP, the LS-FET is momentarily turned off for 200ns and is then turned on again. The MPQ8634A maintains this operation to bring down the output voltage. When V_{FB} drops below 50% of V_{REF} , the LS-FET is turned off for pulse-skip mode and keeps turning on for forced CCM operation. If V_{FB} rises back to more than 116% of V_{REF} , the LS-FET turns on again with NOCP until V_{FB} drops back below 50% of V_{REF} . The power of EN or VIN must be recycled to clear the OVP fault.

The OVP function is enabled after TRK/REF reaches 900mV.

Over-Temperature Protection (OTP)

The MPQ8634A has an over-temperature protection (OTP). The IC monitors the junction temperature internally. If the junction temperature exceeds the threshold value (typically 160°C), the converter shuts off. This is a latch-off protection. Enable the part by recycling the power of VCC or EN.

Output Voltage Setting and Remote Output Voltage Sensing

First choose a value for R1. Then R2 can be determined with Equation (5):

$$R_2(k\Omega) = \frac{V_{REF}}{V_O - V_{REF}} \times R_1(k\Omega) \quad (5)$$

Where V_{REF} is 900mV.

To optimize the load transient response, a feed-forward capacitor (C_{FF}) is recommended in parallel with R1. R1 and C_{FF} add an extra zero to the system, which improves loop response. R1 and C_{FF} are selected so that the zero formed by R1 and C_{FF} is located around 20kHz ~ 60kHz. See Equation (6):

$$f_z = \frac{1}{2\pi \times R1 \times C_{FF}} \quad (6)$$

Power Good (PGOOD)

The MPQ8634A has a power good (PGOOD) output. PGOOD is the open-drain of a MOSFET. Connect PGOOD to VCC or another external voltage source (less than 3.6V) through a pull-up resistor (typically 10kΩ). After applying the input voltage, the MOSFET turns on, so PGOOD is pulled to GND before TRK/REF is ready. After V_{FB} reaches 92.5% of V_{REF} , PGOOD is pulled high after 0.8ms of delay.

When V_{FB} drops to 80% of V_{REF} or exceeds 116% of the nominal V_{REF} , PGOOD is latched low. PGOOD can only be pulled high again after a new soft start.

If the input supply fails to power the MPQ8634A, PGOOD is clamped low, even though PGOOD is tied to an external DC source through a pull-up resistor. The relationship between the PGOOD voltage and the pull-up current is shown in Figure 5.

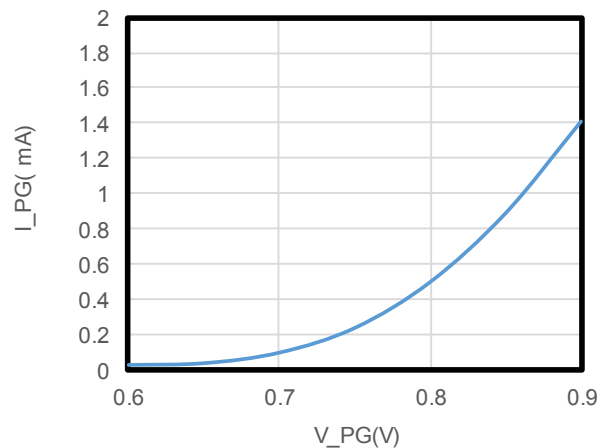

Figure 5: PGOOD Clamped Voltage vs. Pull-Up Current

Enable (EN) Configuration

The MPQ8634A turns on when EN goes high. The MPQ8634A turns off when EN goes low. EN cannot be left floating for proper operation. EN can be driven by an analog or digital control logic signal to enable or disable the MPQ8634A.

The MPQ8634A provides accurate EN thresholds, so a resistor divider from VIN to AGND can be used to program the input voltage at which the MPQ8634A is enabled. This is highly recommended for applications where there is no dedicated EN control logic signal to avoid possible UVLO bouncing during power-up and power-down. The resistor divider values can be determined with Equation (7):

$$V_{IN_START} (V) = V_{IH_EN} \times \frac{R_{UP} + R_{DOWN}}{R_{DOWN}} \quad (7)$$

Where V_{IH_EN} is 1.22V, typically.

R_{UP} and R_{DOWN} should be chosen so that the EN voltage (V_{EN}) does not exceed 3.6V when VIN reaches the maximum value.

EN can also be connected to VIN directly through a pull-up resistor (R_{UP}). R_{UP} should be chosen so that the maximum current going to EN is 50 μ A. R_{UP} can be calculated with Equation (8):

$$R_{UP} (K\Omega) = \frac{V_{IN_MAX} (V)}{0.05(mA)} \quad (8)$$

APPLICATION INFORMATION

Selecting the Input Capacitor

The input current to the step-down converter is discontinuous and therefore requires a capacitor to supply AC current to the step-down converter while maintaining the DC input voltage. Use ceramic capacitors for the best performance. During layout, place the input capacitors as close to VIN as possible.

The capacitance can vary significantly with the temperature. Capacitors with X5R and X7R ceramic dielectrics are recommended because they are fairly stable over a wide temperature range and offer very low ESR.

The capacitors must have a ripple current rating that exceeds the converter's maximum input ripple current. Estimate the input ripple current with Equation (9):

$$I_{CIN} = I_{OUT} \times \sqrt{\frac{V_{OUT}}{V_{IN}} \times \left(1 - \frac{V_{OUT}}{V_{IN}}\right)} \quad (9)$$

The worst-case condition occurs at VIN = 2VOUT, shown in Equation (10):

$$I_{CIN} = \frac{I_{OUT}}{2} \quad (10)$$

For simplification, choose an input capacitor with an RMS current rating that exceeds half the maximum load current. The input capacitor value determines the converter input voltage ripple. If there is an input voltage ripple requirement in the system, select an input capacitor that meets the specification.

Estimate the input voltage ripple with Equation (11):

$$\Delta V_{IN} = \frac{I_{OUT}}{F_{SW} \times C_{IN}} \times \frac{V_{OUT}}{V_{IN}} \times \left(1 - \frac{V_{OUT}}{V_{IN}}\right) \quad (11)$$

The worst-case condition occurs at VIN = 2VOUT, shown in Equation (12):

$$\Delta V_{IN} = \frac{1}{4} \times \frac{I_{OUT}}{F_{SW} \times C_{IN}} \quad (12)$$

Selecting the Output Capacitor

The output capacitor maintains the DC output voltage. Use POSCAP or ceramic capacitors.

Estimate the output voltage ripple with Equation (13):

$$\Delta V_{OUT} = \frac{V_{OUT}}{F_{SW} \times L} \times \left(1 - \frac{V_{OUT}}{V_{IN}}\right) \times \left(R_{ESR} + \frac{1}{8 \times F_{SW} \times C_{OUT}}\right) \quad (13)$$

When using ceramic capacitors, the capacitance dominates the impedance at the switching frequency. The capacitance also dominates the output voltage ripple. For simplification, estimate the output voltage ripple with Equation (14):

$$\Delta V_{OUT} = \frac{V_{OUT}}{8 \times F_{SW}^2 \times L \times C_{OUT}} \times \left(1 - \frac{V_{OUT}}{V_{IN}}\right) \quad (14)$$

The ESR dominates the switching frequency impedance for the POSCAP capacitors. For simplification, the output ripple can be approximated with Equation (15):

$$\Delta V_{OUT} = \frac{V_{OUT}}{F_{SW} \times L} \times \left(1 - \frac{V_{OUT}}{V_{IN}}\right) \times R_{ESR} \quad (15)$$

Selecting the Inductor

The inductor supplies constant current to the output load while being driven by the switching input voltage. A larger-value inductor results in less ripple current and a lower output ripple voltage, but also has a larger physical size, higher series resistance, and lower saturation current. Select an inductor value that allows the inductor peak-to-peak ripple current to be 30 - 40% of the maximum switch current limit. Also design for a peak inductor current that is below the maximum switch current limit. Calculate the inductance value using Equation (16):

$$L = \frac{V_{OUT}}{F_{SW} \times \Delta I_L} \times \left(1 - \frac{V_{OUT}}{V_{IN}}\right) \quad (16)$$

Where ΔIL is the peak-to-peak inductor ripple current.

Choose an inductor that will not saturate under the maximum inductor peak current. The peak inductor current can be calculated with Equation (17):

$$I_{LP} = I_{OUT} + \frac{V_{OUT}}{2 \times F_{SW} \times L} \times \left(1 - \frac{V_{OUT}}{V_{IN}}\right) \quad (17)$$

PCB Layout Guidelines

Efficient PCB layout is critical for stable operation. For optimal performance, refer to Figure 6 and follow the guidelines below.

1. Place the input MLCC capacitors as close to VIN and PGND as possible.
2. Place the major MLCC capacitors on the same layer as the MPQ8634A.
3. Maximize the VIN and PGND copper plane to minimize parasitic impedance.
4. Place as many PGND vias as possible as close to PGND as possible to minimize both parasitic impedance and thermal resistance.
5. Place the VCC decoupling capacitor close to the device.
6. Connect AGND and PGND at the point of the VCC capacitor's ground connection.
7. Place the BST capacitor as close to BST and SW as possible with 20 mil or wider traces to route the path. It is recommended to use a bootstrap capacitor of 0.1 μ F to 1 μ F.
8. Place the REF capacitor close to TRK/REF to VSNS-.
9. Place via at least 10mm away from the positive side of the first input decoupling capacitor close to the IC if it must be placed on the PGOOD pad.
10. Place the OSENSE capacitor in between the output sense lines and close to the device.

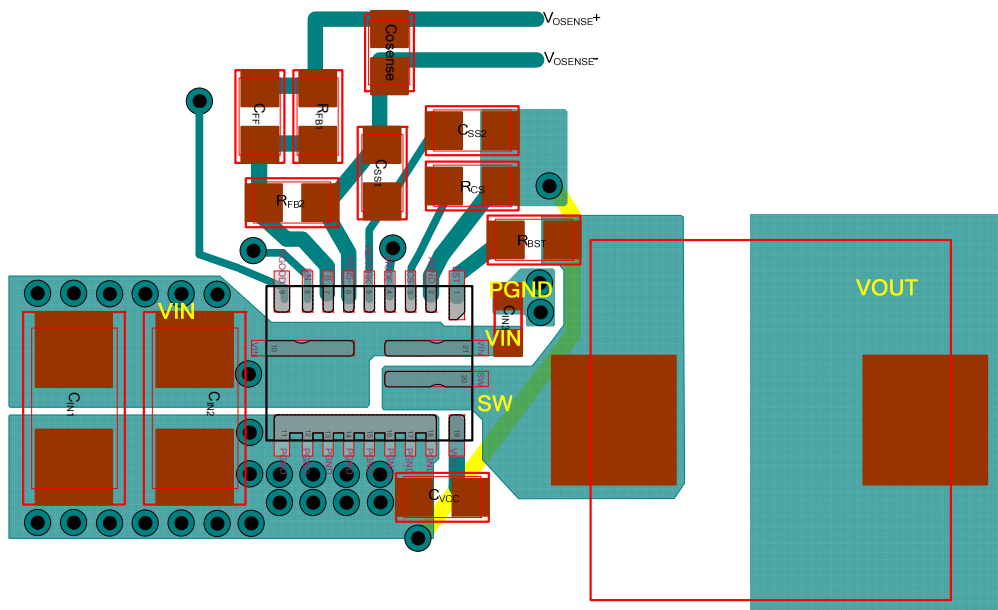
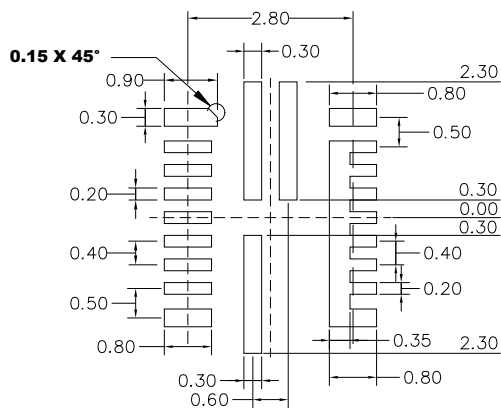
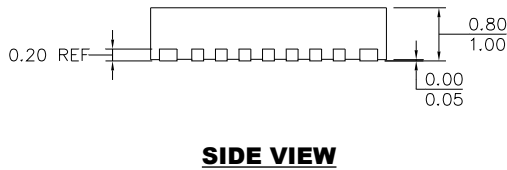
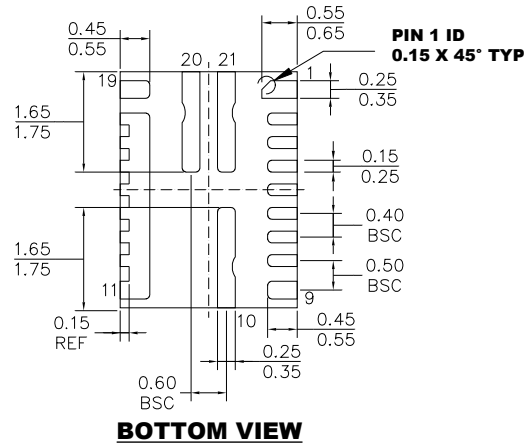
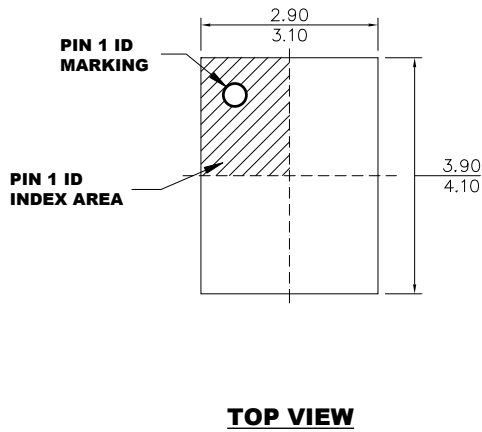

Figure 6: Recommended PCB Layout

PACKAGE INFORMATION

QFN-21 (3mmx4mm)



NOTE:

- 1) LAND PATTERN OF PIN1,9,10,11,19,20 AND 21 HAVE THE SAME WIDTH.
- 2) ALL DIMENSIONS ARE IN MILLIMETERS.
- 3) LEAD COPLANARITY SHALL BE 0.08 MILLIMETERS MAX.
- 4) JEDEC REFERENCE IS MO-220.
- 5) DRAWING IS NOT TO SCALE.

NOTICE: The information in this document is subject to change without notice. Users should warrant and guarantee that third party Intellectual Property rights are not infringed upon when integrating MPS products into any application. MPS will not assume any legal responsibility for any said applications.