

Features:

- Frequency Range: 27.5 – 30 GHz
- P1dB: +36 dBm
- IM3 Level: -38 dBc @Po=20dBm/tone
- Gain: 22 dB
- Vdd = 6V
- Idsq = 1500 to 2800mA
- Input and Output Fully Matched to 50 Ω
- Surface Mount, RoHs Compliant QFN 5x5mm package

Applications:

- P2P Radio
- V-sat

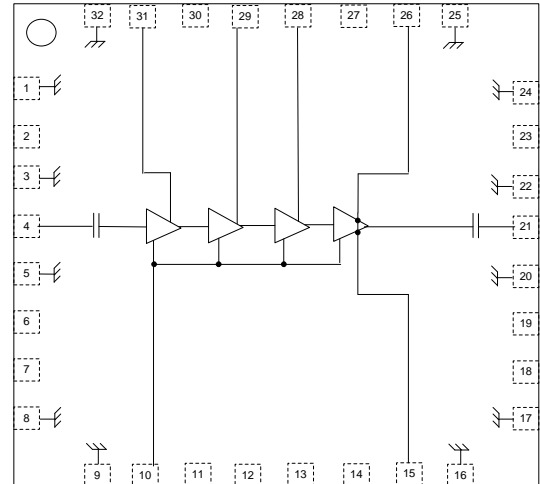

Functional Block Diagram

Description:

The MMA-273033-M5 is a high power amplifier MMIC in a surface mount package designed for use in transmitters that operate at frequencies between 27.5GHz and 30GHz. In the operational frequency band, it provides 36dBm of output power (P-1dB) and 22dB of small-signal gain.

Absolute Maximum Ratings: *(Ta= 25 °C)**

SYMBOL	PARAMETERS	UNITS	Min.	Max.
Vds	Drain-Source Voltage	V		6.5
Vg	Gate-Source Voltage	V	-2.1	0
Ig	First Gate Current	mA	-17	17
Pd	Power Dissipation	W		24
Pin max	RF Input Power	dBm		20
Toper	Operating Temperature	°C		-40 to +85
Tch	Channel Temperature	°C		+160
Tstg	Storage Temperature	°C		-55 to +150
Tmax	Max. Assembly Temp (20 sec max)	°C		+250

*Operation of this device above any one of these parameters may cause permanent damage.

ECCN: EAR99



MMA-273036-M5

27.5-30GHz 4W MMIC Power Amplifier Data Sheet

Electrical Specifications: *V_{ds}=6V, V_{gs}=-0.85V, I_{dsq}=2200mA, T_a=25 °C Z₀=50 ohm*

Parameter	Units	Typical Data
Frequency Range	GHz	27.5-30
Gain (Typ / Min)	dB	22 / 20
Gain Flatness (Typ / Max)	+/-dB	3 / 4
Input RL(Typ/Max)	dB	10/8
Output RL(Typ/Max)	dB	10/8
Output P1dB(Typ/Min)	dBm	35.5/35
Output P3dB(Typ/Min)	dBm	36.5/36
IM3 Level ⁽¹⁾	dBc	-36
Thermal Resistance	°C/W	3.8
Operating Current at P1dB(Typ / Max)	mA	2500 / 3000

(1) Output IP3 is measured with two tones at output power of 20 dBm/tone separated by 20 MHz.

Typical RF Performance: $V_{ds}=6V$, $V_{gsq}=-0.85V$, $I_{dsq}=2200mA$, $Z_0=50\text{ ohm}$, $T_a=25\text{ }^\circ C$

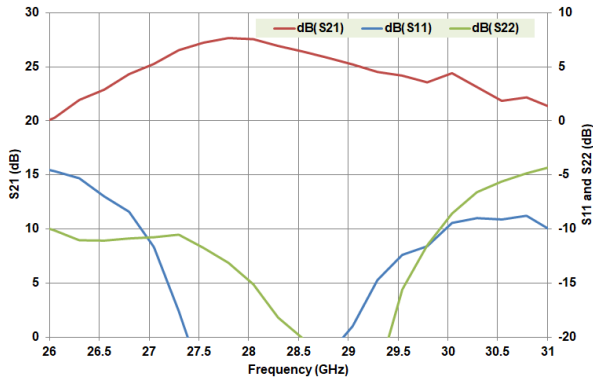

S11, S21 and S22 vs. Frequency

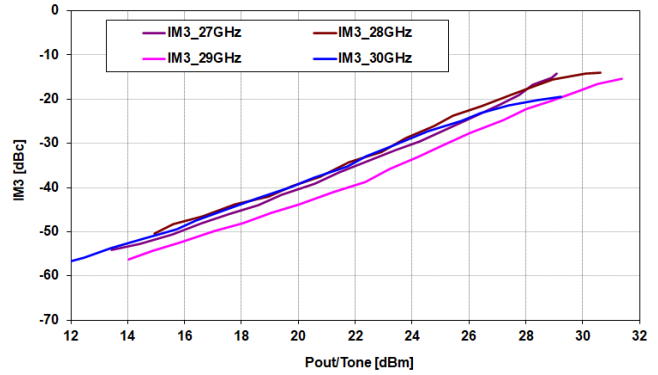

IM3 level [dBc] vs. Output power/tone [dBm] (Page 3)

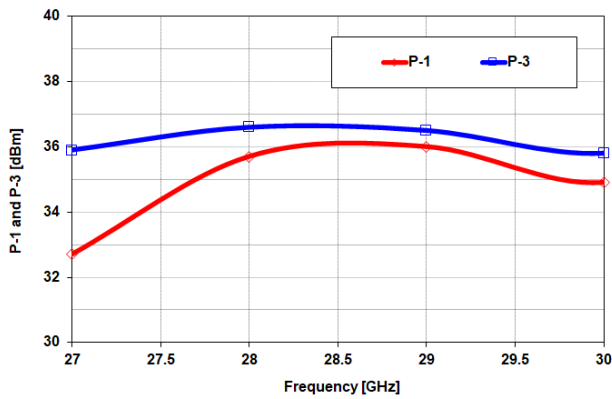

P-1 and P-3 vs Frequency

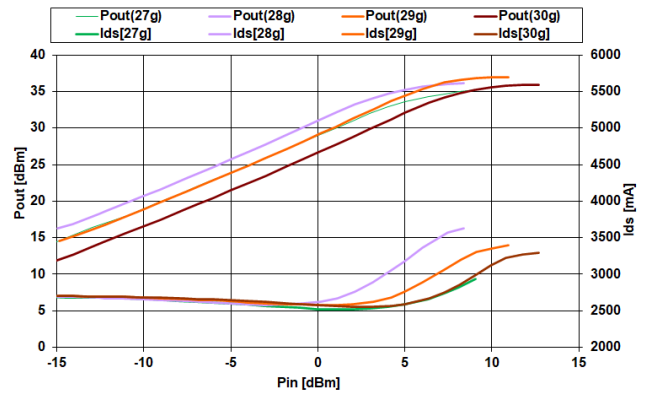

Po(dBm), and Ids(mA) vs. Pin(dBm)

Typical Bias dependent RF Performance:

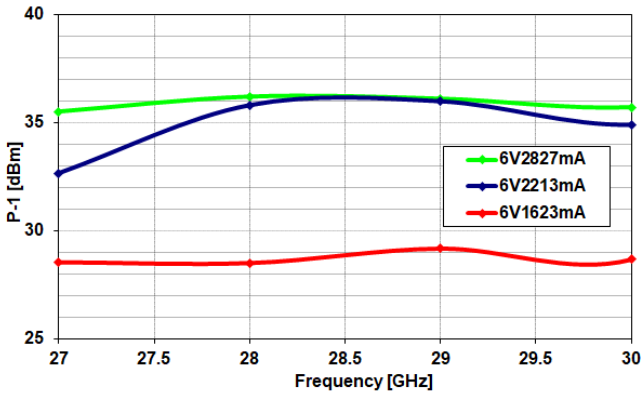

Bias dependent P1 vs. Frequency

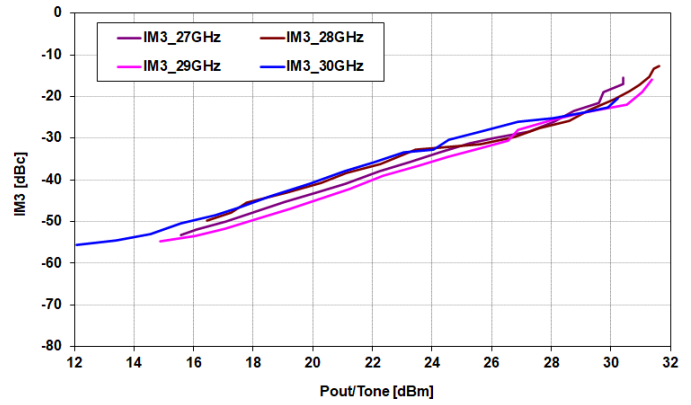

IM3 Level [dBc] vs. output power/tone [dBm] @Vds=6V, Idsq=2.8A

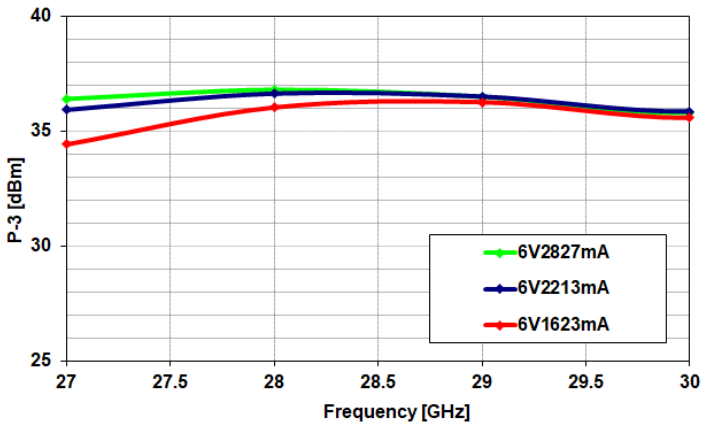

Bias dependent P-3 vs. Frequency

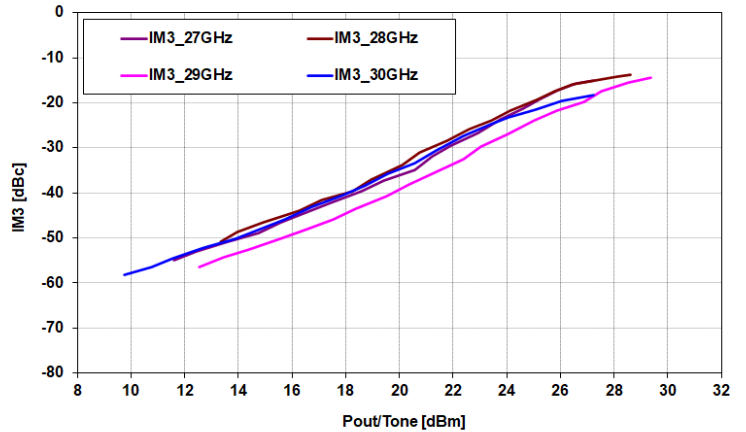

Pout[dBm], and Ids[mA] vs. Input power [dBm] @Vds=6V, Idsq=1.5A



MMA-273036-M5

27.5-30GHz 4W MMIC Power Amplifier

Data Sheet

Applications

The **MMA-273036-M5** MMIC power amplifier is designed for use as a power stage amplifier in microwave transmitters. It is ideally suited for 27.5 to 30GHz band V-sat transmitter applications requiring excellent saturated output power performance. This amplifier is provided as a 5x5mm QFN package, and the packaged amplifier is fully compatible with industry standard high volume surface mount PCB assembly processes.

Biassing and Operation

The recommended bias conditions for best performance for the **MMA-273036-M5** are $V_{DD} = 6.0V$, $I_{dsq} = 2200mA$. Performance improvements are possible depending on applications. The drain bias voltage range is 5 to 6V and the quiescent drain current biasing range is 1500mA to 2800mA. A single DC gate supply connected to V_g will bias all the amplifier stages. Muting can be accomplished by setting V_g to the pinch-off voltage ($V_p = -2V$). The gate voltage (V_g) should be applied prior to the drain voltages (V_{d1} , V_{d2} , V_{d3}) during power up and removed after the drain voltages during power down. The RF input and output ports are DC decoupled internally. Typical DC supply connection with bi-passing capacitors for the **MMA-273036-M5** is shown in following pages.

Assembly Techniques

GaAs MMICs are ESD sensitive. ESD preventive measures must be employed in all aspects of storage, handling, and assembly. MMIC ESD precautions, handling considerations, die attach and bonding methods are critical factors in successful GaAs MMIC performance and reliability.

Package Pin-out:

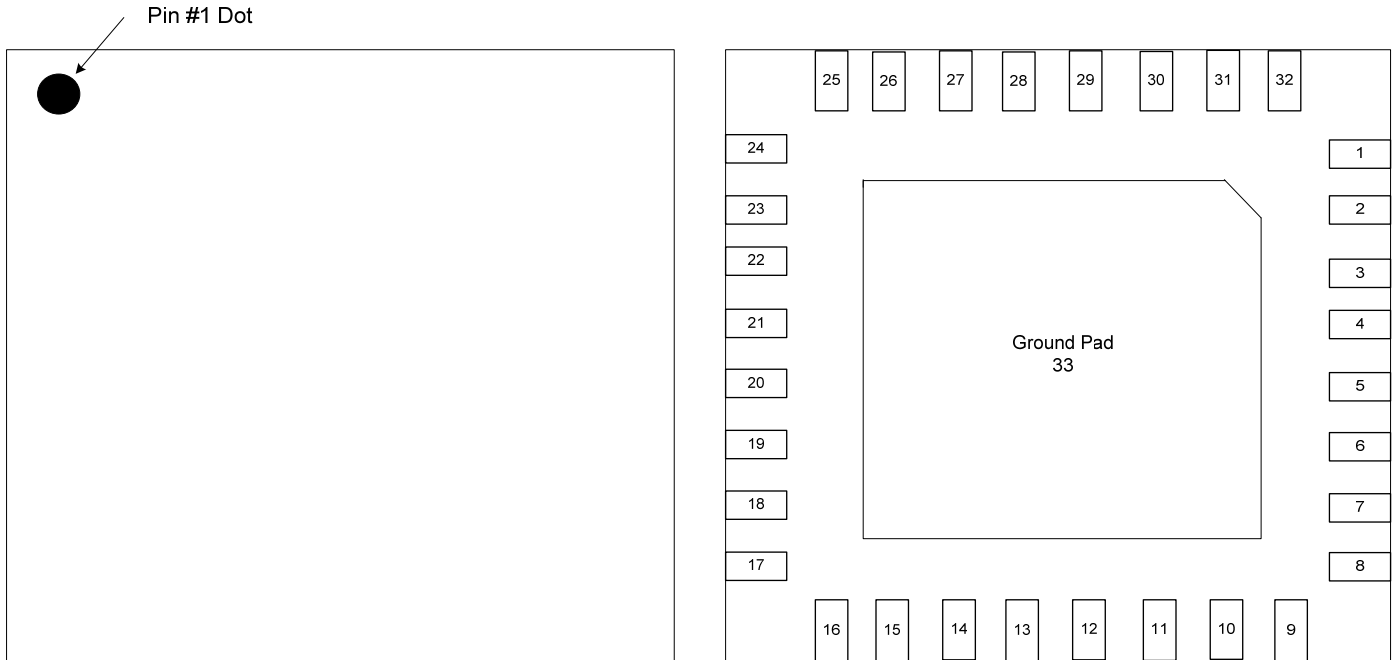

Pin	Description
4	RF Input
21	RF Output
10	Vg
31	Vd1
29	Vd2
28	Vd3
15, 26	Vd4
1, 3, 5, 8, 9, 16, 17, 20, 22, 24, 25, 32, 33	Ground
2, 6, 7, 11, 12, 13, 14, 18, 19, 23, 27, 30	N/C

Mechanical Information:

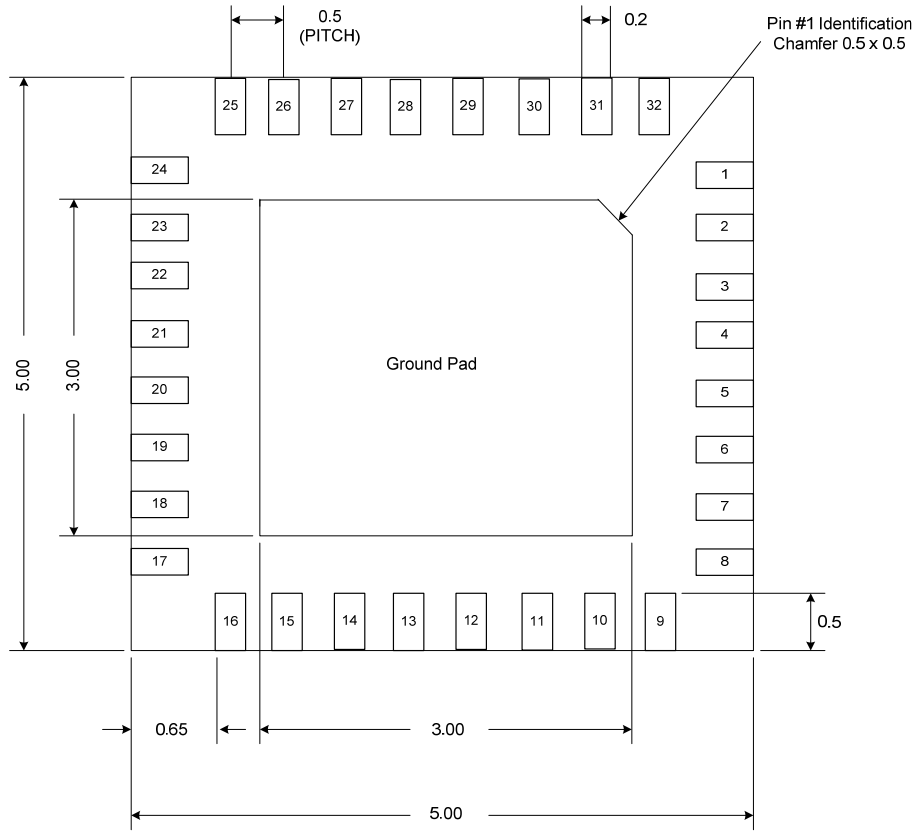

BOTTOM VIEW

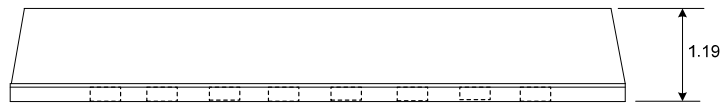

SIDE VIEW

The units are in [mm].

Application Circuit:

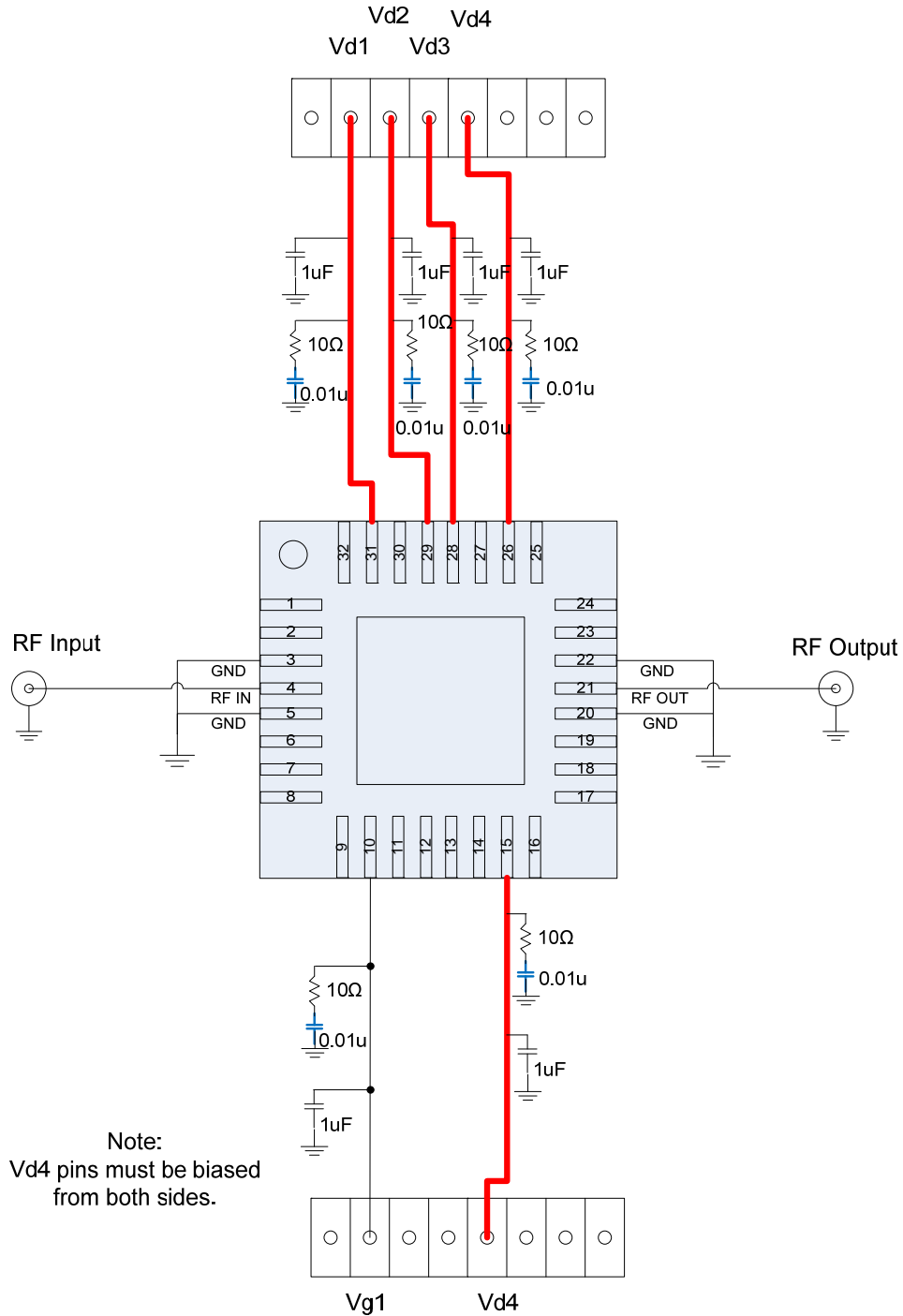

Recommended Application Board Design:

Board Material is 10mil (Dielectric) thickness Rogers 4350B with 0.5oz copper clads.
Board is soldered on a gold plated solid copper block and adequate heat-sinking is required for 16.8W total power dissipation.

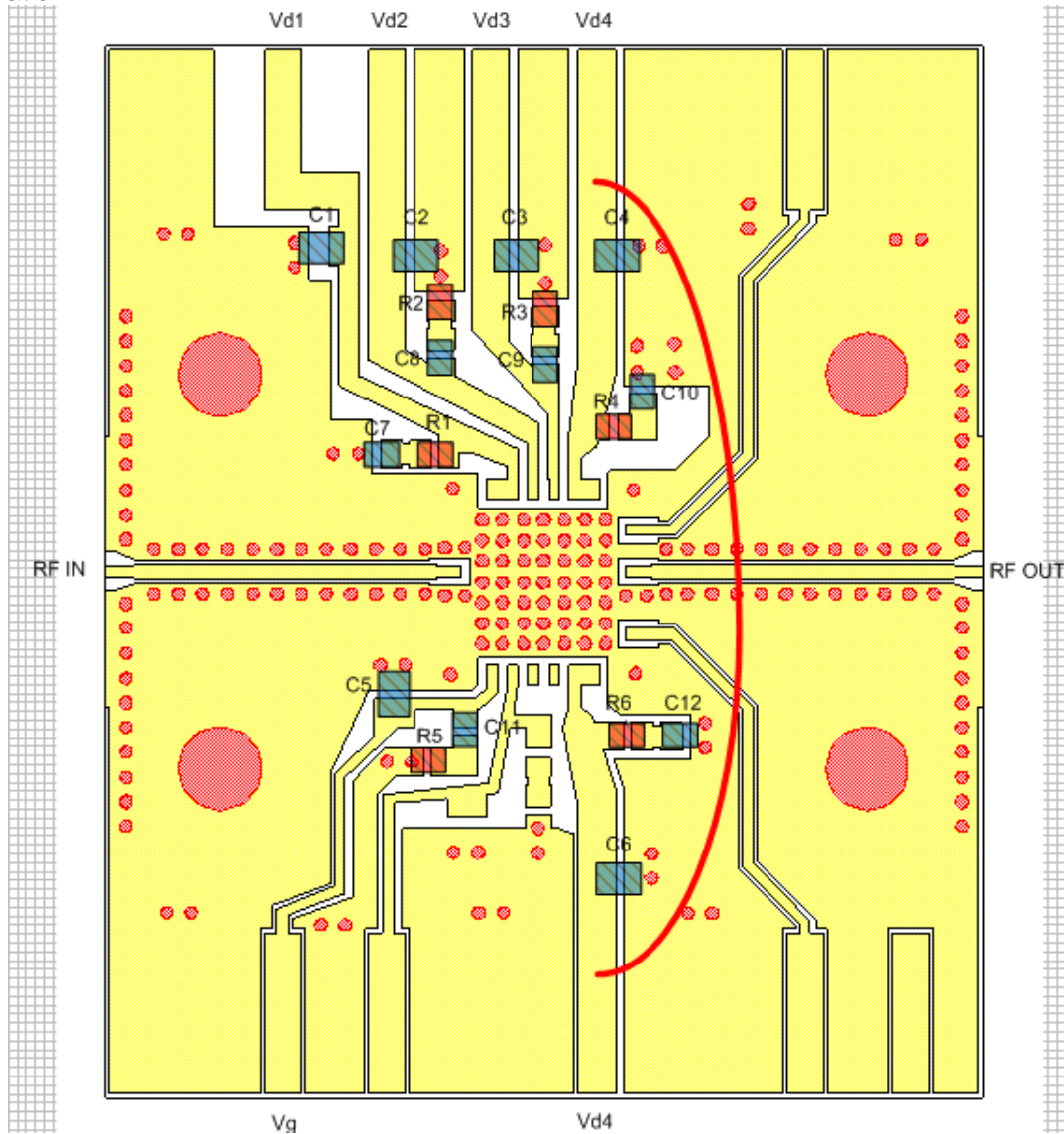

Part	Description
C1, C2, C3, C4, C5, C6	1uF capacitor (0603)
C7, C8, C9, C10, C11, C12	0.01uF Capacitor (0402)
R1, R2, R3, R4, R5, R6	10Ω Resistor (0402)

Recommended Application Board Design:

Board Material is 10mil (Dielectric) thickness Rogers 4350B with 0.5oz copper clads. The board material and mounting pattern, as defined in the data sheet, optimizes RF performance and is strongly recommended. An electronic drawing of the land pattern is available upon request from MwT Sales & Application Engineering.

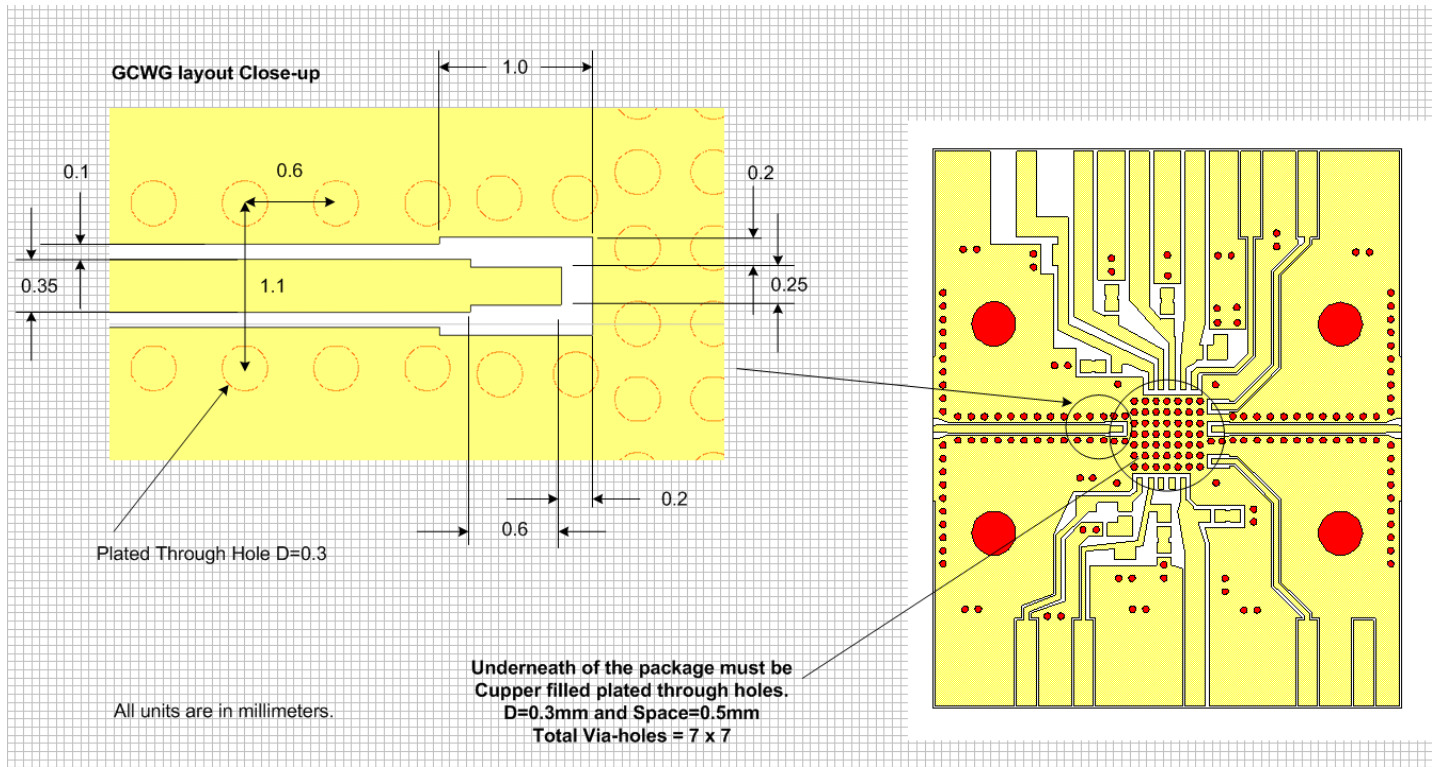

Copper filled thru vias
D=0.3mm, Space=0.5mm
7x7

For best thermal
dissipation, 3mm square
Copper filled PCB is
recommended.

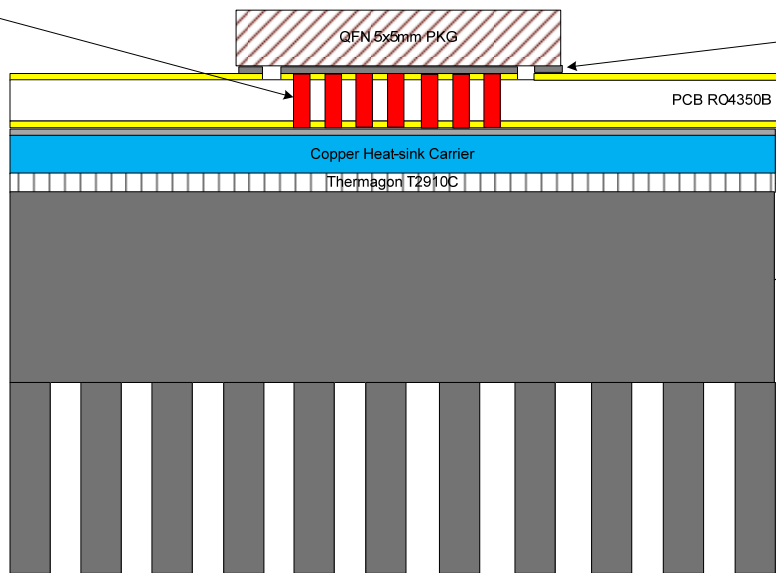

SolderPlus 62NCLR-A

Rogers RO4350B,
T=0.25mm with 17.5um
copper clads

Indium Solder 60% In, 40% PB

2.5mm Thk. Cu Carrier

Thermagbn T2910C

Aluminum-alloy
Heat-sink