

Single Supply V_{IN} , Low V_{IN} , Low V_{OUT} , 3A LDO

Features

- Input Voltage Range V_{IN} : +1.65V to +5.5V
- Maximum Dropout ($V_{IN} - V_{OUT}$) of 500 mV over Temperature
- Adjustable Output Voltage Down to 0.5V
- Stable with 10 μ F Ceramic Output Capacitor
- Excellent Line and Load Regulation
- Logic Controlled Shutdown
- Thermal Shutdown and Current-Limit Protection
- Error Flag Output
- 5-Lead TO-263 Package
- 5-Lead S-PAK Package
- ePad SOIC-8 Package
- 12-Lead 4 mm x 4 mm DFN Package (MIC69303 Only)
- -40°C to $+125^{\circ}\text{C}$ Junction Temperature Range

Applications

- Point-of-Load Applications
- Industrial Power
- Sensitive RF Applications

General Description

The MIC69301, MIC69302, MIC69303 are the 3A output current members of the MIC69xxx family of high current, low voltage regulators that support currents of 1A, 1.5A, 3A, and 5A. This family operates from a single low voltage supply and offers high precision and ultra low dropout of 500 mV under worst case conditions.

The MIC69301/2/3 operate from an input voltage of 1.65V to 5.5V. It is designed to drive digital circuits that require low voltage at high currents (i.e., PLDs, DSP, microcontroller, etc.). These regulators are available in adjustable and fixed output voltages. The adjustable version can support output voltages down to 0.5V.

The μ Cap design of the MIC69301/2/3 is optimized for stability with low value, low-ESR ceramic output capacitors.

Features of the MIC69301/2/3 include thermal shutdown and current limit protection. Logic enable and error flag pins are also available.

The MIC69301/2/3 are offered in TO-263, S-PAK, and the ePad SOIC-8 packages. The MIC69303 is also available in a 12-lead 4 mm x 4 mm DFN package. All packages have an operating temperature range of -40°C to $+125^{\circ}\text{C}$.

Typical Application Circuits

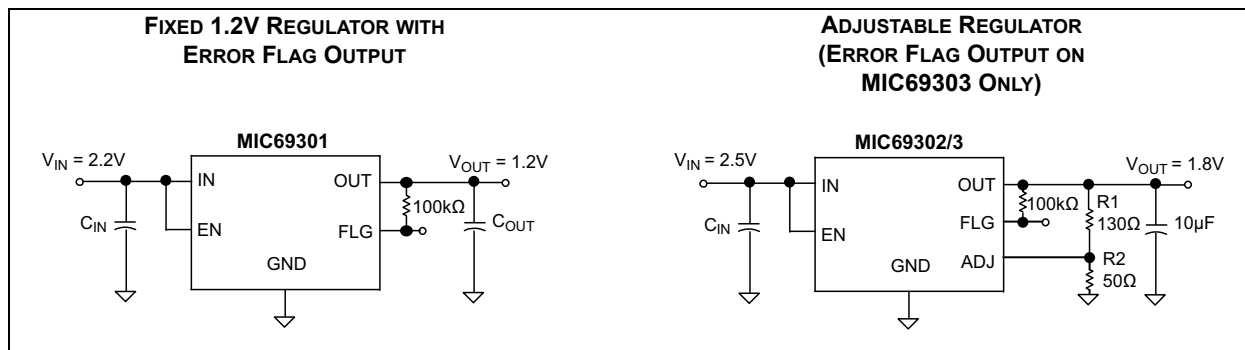

MIC69301/2/3

Pin Configurations

MIC69301/2
5-Lead TO-263 (U)
Adjustable Voltage

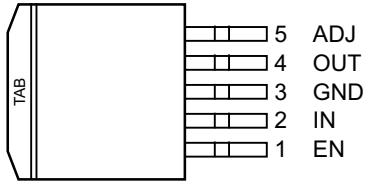

MIC69301/2
5-Lead TO-263 (U)
Fixed Voltage with Flag

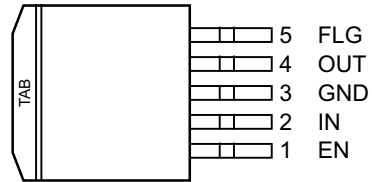

MIC69301/2
5-Lead S-PAK (R)
Adjustable Voltage

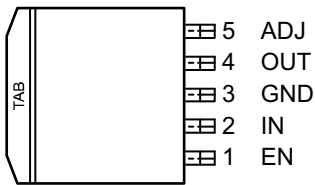

MIC69301/2
5-Lead S-PAK (R)
Fixed Voltage with Flag

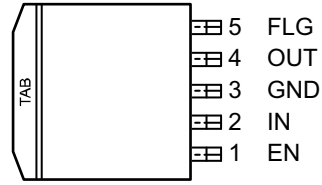

MIC69301/3
8-Lead ePad SOIC (ME)
Adjustable Voltage

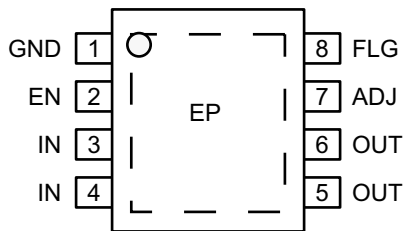

MIC69301/3
8-Lead ePad SOIC (ME)
Fixed Voltage with Flag

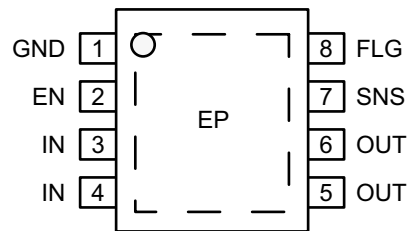

MIC69303
12-Lead 4 mm x 4 mm DFN (ML)
Adjustable Voltage with Flag

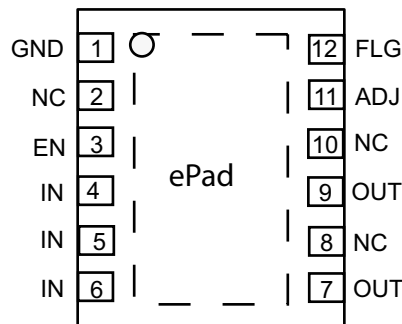

Functional Block Diagrams

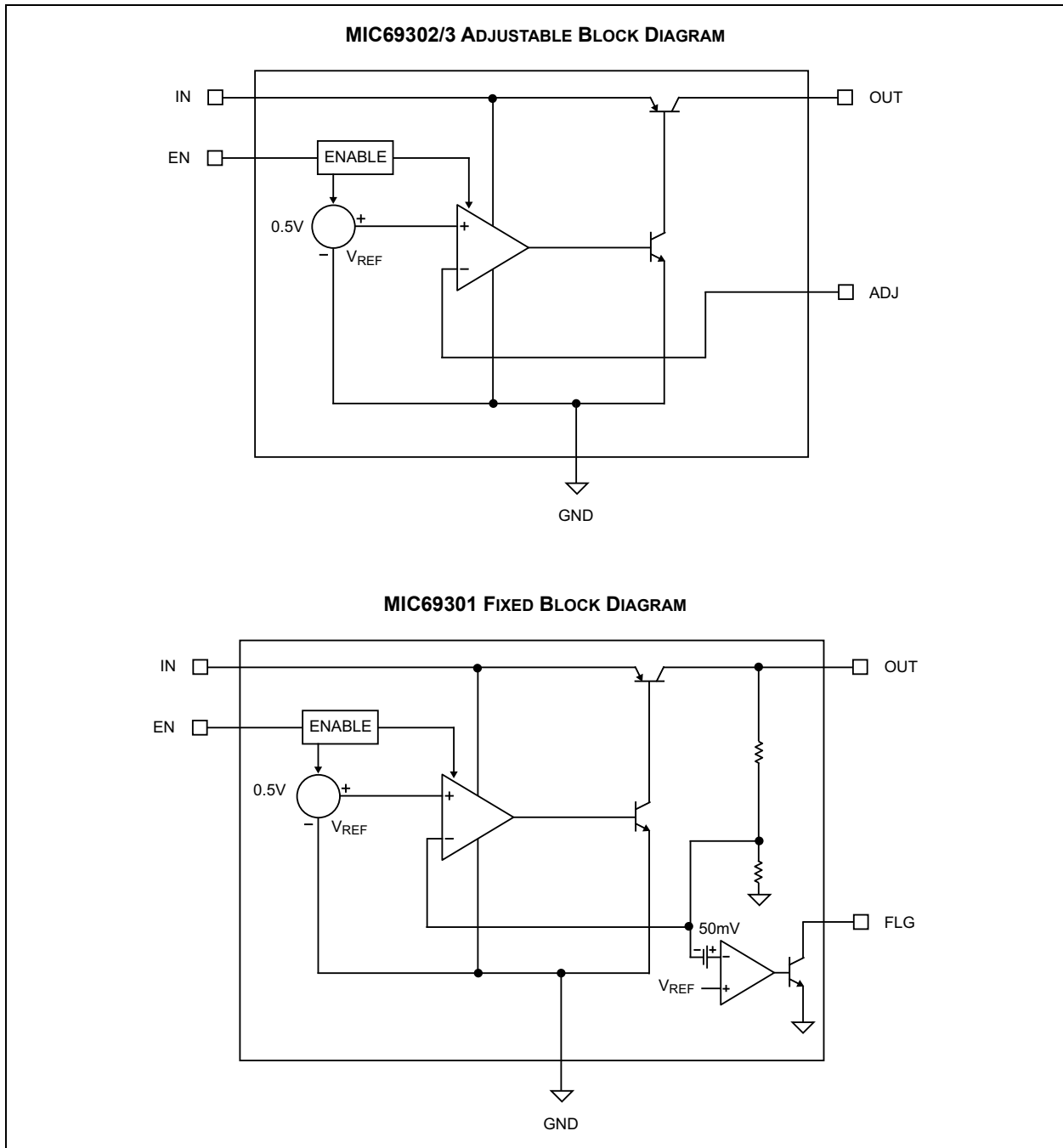

MIC69301/2/3

1.0 ELECTRICAL CHARACTERISTICS

Absolute Maximum Ratings †

Supply Input Voltage (V_{IN} to GND).....	-0.3V to +6V
Logic Input Voltage (V_{EN} to GND).....	-0.3V to ($V_{IN} + 0.3V$)
Fault Flag (V_{FLG} to GND).....	-0.3V to +6V
ESD Rating (Note 1).....	2 kV

Operating Ratings ††

Supply Voltage (V_{IN}).....	+1.65V to +5.5V
Enable Input Voltage (V_{EN}).....	0V to V_{IN}
Power Dissipation (Note 2).....	Internally Limited

† **Notice:** Stresses above those listed under “Absolute Maximum Ratings” may cause permanent damage to the device. This is a stress rating only and functional operation of the device at those or any other conditions above those indicated in the operational sections of this specification is not intended. Exposure to maximum rating conditions for extended periods may affect device reliability.

†† **Notice:** The device is not guaranteed to function outside its operating ratings.

Note 1: Specification for packaged product only.

2: The maximum allowable power dissipation of any T_A (ambient temperature) is $P_{D(MAX)} = (T_{J(MAX)} - T_A) \div \theta_{JA}$. Exceeding the maximum allowable power dissipation will result in excessive die temperature, and the regulator will go into thermal shutdown.

ELECTRICAL CHARACTERISTICS

Electrical Characteristics: $T_A = +25^\circ\text{C}$ with $V_{IN} = V_{OUT} + 1V$; **bold** values indicate $-40^\circ\text{C} < T_J < +125^\circ\text{C}$; $I_{OUT} = 10\text{ mA}$; $C_{OUT} = 10\text{ }\mu\text{F}$ ceramic, unless noted. [Note 1](#)

Parameter	Sym.	Min.	Typ.	Max.	Units	Conditions
Power Input Supply						
Input Voltage Range	V_{IN}	1.65	—	5.5	V	—
Ground Pin Current	I_{GND}	—	1.2	5	mA	$I_{OUT} = 10\text{ mA}$
		—	12	30	mA	$I_{OUT} = 1.5\text{ A}$
		—	32	75	mA	$I_{OUT} = 3\text{ A}$
Ground Pin Current in Shutdown	—	—	1	—	μA	$V_{EN} = 0V$; $V_{IN} = 2.0V$; $V_{OUT} = 0V$
Output Voltage						
Output Voltage (Fixed)	V_{OUT}	$V_R - \mathbf{2.0}$	—	$V_R + \mathbf{2.0}$	V	Note 2
Load Regulation	—	—	± 0.3	—	%	$I_{OUT} = 10\text{ mA to }3A$
Line Regulation (Note 3)	—	—	0.2	0.3	%/V	$V_{IN} = (V_{OUT} + 1.0V)$ to 5.5V

Note 1: Specification for packaged product only.

2: V_R is the nominal regulator output voltage when the input voltage is $V_{IN} = V_{OUT} + 1V$ or $V_{IN} = 1.65V$ (whichever is greater).

3: Minimum input for line regulation test is set to $V_{OUT} + 1V$ relative to the highest output voltage.

4: Dropout voltage is defined as the input-to-output differential at which the output voltage drops 2% below its nominal value measured at 1V differential. For outputs below 1.65V, dropout voltage is considered the input-to-output voltage differential with the minimum input voltage of 1.65V. Minimum input operating voltage is 1.65V.

ELECTRICAL CHARACTERISTICS (CONTINUED)

Electrical Characteristics: $T_A = +25^\circ\text{C}$ with $V_{IN} = V_{OUT} + 1\text{V}$; **bold** values indicate $-40^\circ\text{C} < T_J < +125^\circ\text{C}$; $I_{OUT} = 10\text{ mA}$; $C_{OUT} = 10\text{ }\mu\text{F}$ ceramic, unless noted. [Note 1](#)

Parameter	Sym.	Min.	Typ.	Max.	Units	Conditions
Reference (Adjustable)						
Feedback Reference Voltage (ADJ Pin)	—	0.490	0.5	0.510	V	$\pm 2.0\%$
Feedback Bias Current	—	—	0.25	1.0	μA	$V_{ADJ} = 0.5\text{V}$
Current Limit						
Current Limit	I_{LIM}	3.3	5.2	—	A	$V_{OUT} = 0\text{V}$
Power Dropout Voltage						
Dropout Voltage (Note 4)	$V_{IN} - V_{OUT}$	—	200	300	mV	$I_{OUT} = 1.5\text{A}$
		—	275	500	mV	$I_{OUT} = 3\text{A}$
Enable Input						
Enable Input Threshold	—	0.8	0.57	—	V	Regulator Enabled
		—	—	0.2		Regulator Shut Down
Enable Pin Bias Current	—	—	0.0	—	μA	$V_{EN} \leq 0.2\text{V}$ (Regulator Shutdown)
		—	7.0	—		$V_{EN} \geq 0.8\text{V}$ (Regulator Enabled)
Turn-On Time	t_{ON}	—	10	150	μs	90% of typical V_{OUT} ; $V_{EN} = V_{IN}$
Fault Output						
Fault Threshold Voltage	—	7.5	10	14	%	% of V_{OUT} below nominal output (V_{OUT} Falling)
Fault Hysteresis	—	—	2.0	—	%	—
Fault Output Low Voltage	—	—	150	—	mV	$I_{FLG} = 250\text{ }\mu\text{A}$ (sinking), $V_{EN} = 0\text{V}$
Fault Leakage Current	—	—	0.05	—	μA	$V_{FLG} = 5.0\text{V}$; $V_{EN} = 0\text{V}$
Thermal Protection						
Overtemperature Shutdown	—	—	165	—	$^\circ\text{C}$	T_J rising
Overtemperature Shutdown Hysteresis	—	—	10	—	$^\circ\text{C}$	—

Note 1: Specification for packaged product only.

- 2:** V_R is the nominal regulator output voltage when the input voltage is $V_{IN} = V_{OUT} + 1\text{V}$ or $V_{IN} = 1.65\text{V}$ (whichever is greater).
- 3:** Minimum input for line regulation test is set to $V_{OUT} + 1\text{V}$ relative to the highest output voltage.
- 4:** Dropout voltage is defined as the input-to-output differential at which the output voltage drops 2% below its nominal value measured at 1V differential. For outputs below 1.65V, dropout voltage is considered the input-to-output voltage differential with the minimum input voltage of 1.65V. Minimum input operating voltage is 1.65V.

MIC69301/2/3

TEMPERATURE SPECIFICATIONS

Parameters	Sym.	Min.	Typ.	Max.	Units	Conditions
Temperature Ranges						
Operating Junction Temperature Range	T_J	-40	—	+125	°C	Note 1
Storage Temperature Range	T_S	-65	—	+125	°C	—
Lead Temperature	T_{LEAD}	—	—	+260	°C	—
Package Thermal Resistance						
Thermal Resistance, S-PAK 5-Ld	θ_{JC}	—	2	—	°C/W	—
Thermal Resistance, S-PAK 5-Ld	θ_{JA}	—	38	—	°C/W	—
Thermal Resistance, TO-263 5-Ld	θ_{JC}	—	2	—	°C/W	—
Thermal Resistance, ePad SOIC 8-Ld	θ_{JA}	—	41	—	°C/W	—
Thermal Resistance, DFN 12-Ld	θ_{JA}	—	60	—	°C/W	—

Note 1: The maximum allowable power dissipation is a function of ambient temperature, the maximum allowable junction temperature and the thermal resistance from junction to air (i.e., T_A , T_J , θ_{JA}). Exceeding the maximum allowable power dissipation will cause the device operating junction temperature to exceed the maximum +125°C rating. Sustained junction temperatures above +125°C can impact the device reliability.

2.0 TYPICAL PERFORMANCE CURVES

Note: The graphs and tables provided following this note are a statistical summary based on a limited number of samples and are provided for informational purposes only. The performance characteristics listed herein are not tested or guaranteed. In some graphs or tables, the data presented may be outside the specified operating range (e.g., outside specified power supply range) and therefore outside the warranted range.

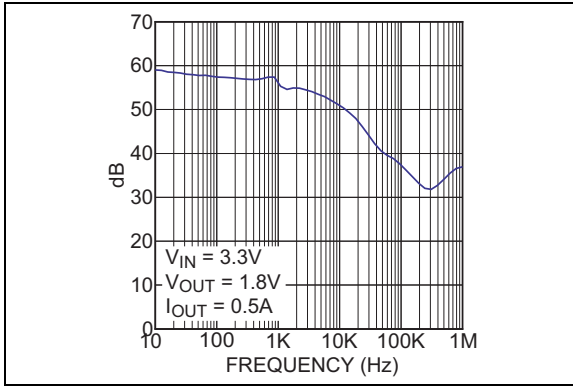

FIGURE 2-1: Power Supply Rejection Ratio.

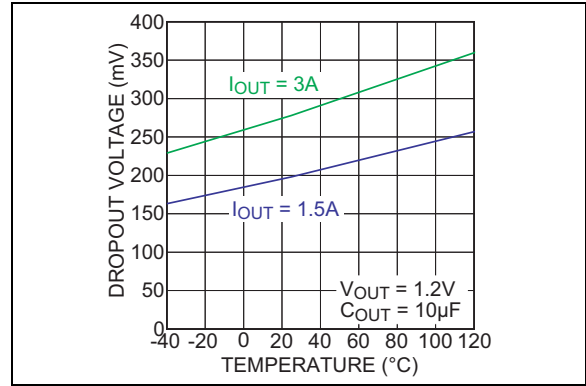

FIGURE 2-4: Dropout Voltage vs. Temperature.

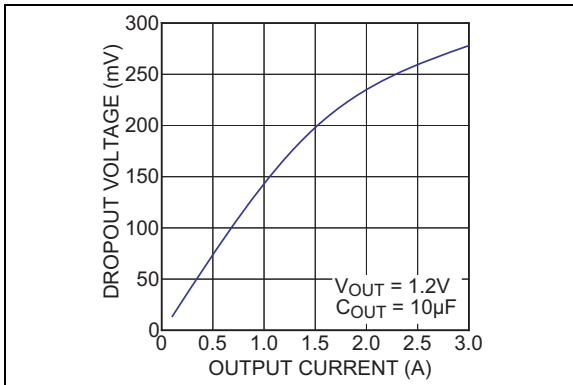

FIGURE 2-2: Dropout Voltage vs. Output Current.

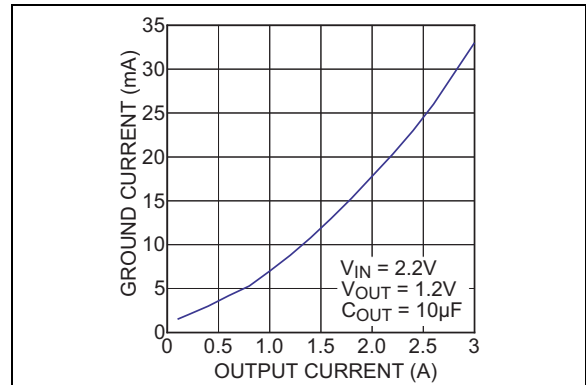

FIGURE 2-5: Ground Current vs. Output Current.

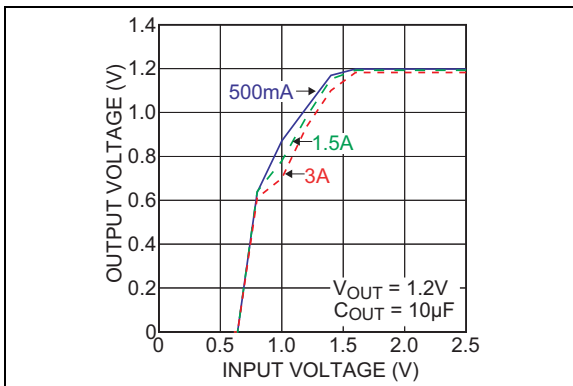

FIGURE 2-3: Dropout Voltage vs. Input Voltage.

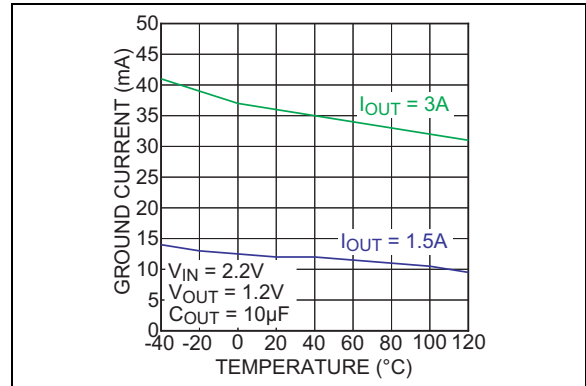

FIGURE 2-6: Ground Current vs. Temperature.

MIC69301/2/3

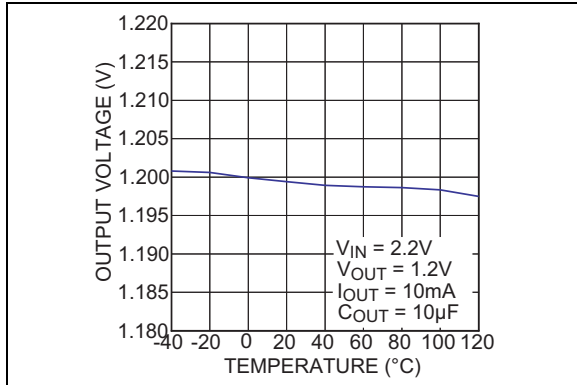

FIGURE 2-7: Output Voltage vs. Temperature.

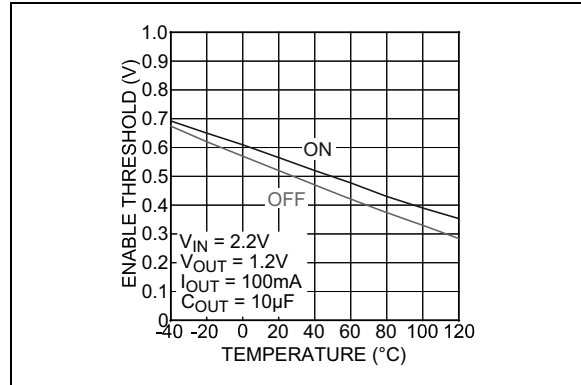

FIGURE 2-10: Enable Threshold vs. Temperature.

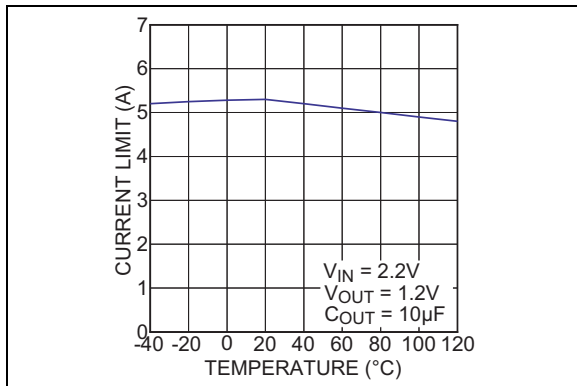

FIGURE 2-8: Current Limit vs. Temperature.

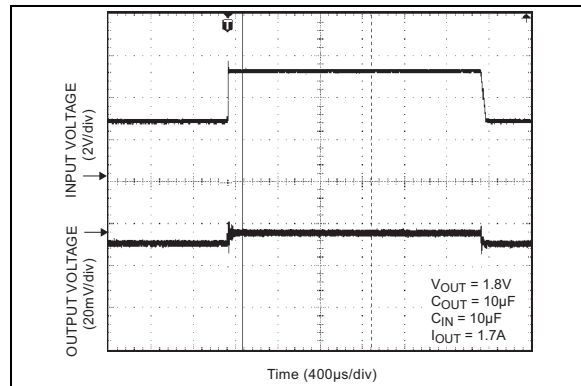

FIGURE 2-11: Line Transient.

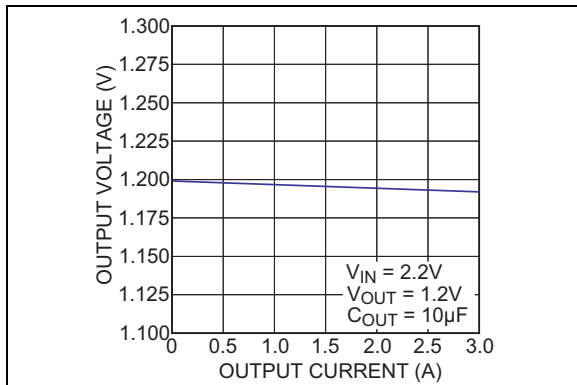

FIGURE 2-9: Load Regulation.

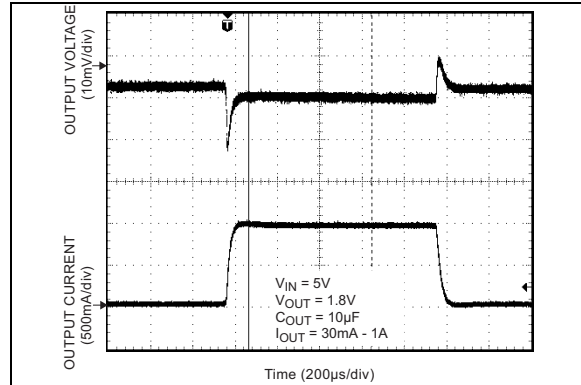

FIGURE 2-12: Load Transient.

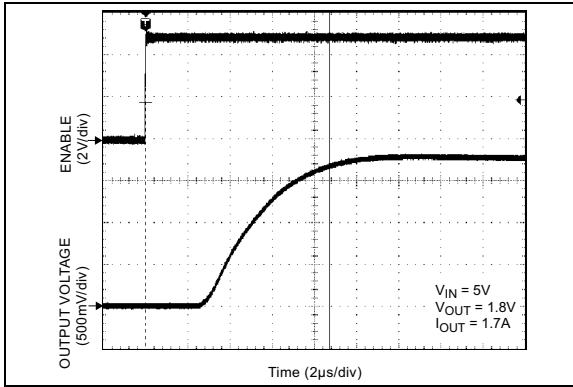

FIGURE 2-13: *Enable Turn-On.*

MIC69301/2/3

3.0 PIN DESCRIPTIONS

The descriptions of the pins are listed in [Table 3-1](#).

TABLE 3-1: PIN FUNCTION TABLE

Pin Number (Fixed) S-PAK, TO-263	Pin Number (Adj.) S-PAK, TO-263	Pin Number (Fixed) ePad SOIC	Pin Number (Adj.) ePad SOIC	Pin Number (Adj.) ePad DFN	Pin Name	Description
1	1	2	2	3	EN	Enable (Input): CMOS compatible input. Logic high = enable, logic low = shutdown. Do not leave pin floating.
2	2	3, 4	3, 4	4, 5, 6	IN	Input voltage that supplies current to the output power device.
3, TAB	3, TAB	1	1	1	GND	Ground (TAB is connected to ground on S-PAK and TO-263).
4	4	5, 6	5, 6	7, 9	OUT	Regulator Output.
—	—	7	—	—	SNS	Output voltage sense. Connect to output voltage.
—	5	—	7	11	ADJ	Adjustable regulator feedback input. Connect to resistor voltage divider.
5	—	8	8	12	FLG	Error Flag (Output): Open collector output. Active-low indicates an output fault condition.
—	—	EP	EP	EP	EP	Exposed pad. Connect to GND.
—	—	—	—	2, 8, 10	NC	No Connect. Not internally connected.

4.0 FUNCTIONAL DESCRIPTION

The MIC69301/2/3 are ultra-high performance low dropout linear regulators designed for high current applications that require a fast transient response. It utilizes a single input supply and has a very low dropout voltage that is perfect for low-voltage DC-to-DC conversions. The MIC69301/2/3 require a minimum number of external components.

The MIC69301/2/3 regulators are fully protected from damage due to fault conditions offering constant current limiting and thermal shutdown.

4.1 Input Supply Voltage

V_{IN} provides a high current to the collector of the pass transistor. The minimum input voltage is 1.65V, allowing conversion from low voltage supplies.

4.2 Output Capacitor

The MIC69301/2/3 require a minimum of output capacitance to maintain stability. However, proper capacitor selection is important to ensure desired transient response. The MIC69301/2/3 are specifically designed to be stable with low-ESR ceramic chip capacitors. A 10 μ F ceramic chip capacitor should satisfy most applications. Output capacitance can be increased without bound. See the [Typical Performance Curves](#) for examples of load transient response.

X7R dielectric ceramic capacitors are recommended because of their temperature performance. X7R-type capacitors change capacitance by only 15% over their operating temperature range and are the most stable type of ceramic capacitors. Z5U and Y5V dielectric capacitors change value by as much as 50% and 60%, respectively over their operating temperature ranges. To use a ceramic chip capacitor with Y5V dielectric the value must be much higher than an X7R ceramic or a tantalum capacitor to ensure the same capacitance value over the operating temperature range. Tantalum capacitors have a very stable dielectric (10% over their operating temperature range) and can also be used with this device.

4.3 Input Capacitor

An input capacitor of 1 μ F or greater is recommended when the device is more than 4 inches away from the bulk supply capacitance or when the supply is a battery. Small, surface mount, ceramic chip capacitors can be used for the bypassing. The capacitor should be placed within 1 inch of the device for optimal performance. Larger values will help to improve ripple rejection by bypassing the input to the regulator further improving the integrity of the output voltage.

4.4 Minimum Load Current

The MIC69301/2/3 regulator is specified between finite loads. If the output current is too small, leakage currents dominate and the output voltage rises. A 10 mA minimum load current is necessary for proper operation.

4.5 Adjustable Regulator Design

The MIC69302 and MIC69303 adjustable version allows programming the output voltage anywhere between 0.5V and 5.0V with two resistors. The resistor value between V_{OUT} and the adjust pin should not exceed 10 k Ω . Larger values can cause instability. The resistor values are calculated by:

EQUATION 4-1:

$$V_{OUT} = 0.5 \times \left(\frac{R1}{R2} + 1 \right)$$

Where:

V_{OUT} = Desired output voltage.

4.6 Enable

The fixed output voltage versions of the MIC69301 feature an active-high enable input (EN) that allows on-off control of the regulator. Current drain reduces to near zero when the device is shutdown, with only microamperes of leakage current. EN may be directly tied to V_{IN} and pulled up to the maximum supply voltage.

4.7 Thermal Design

Linear regulators are simple to use. The most complicated design parameters to consider are thermal characteristics. Thermal design requires the following application-specific parameters:

- Maximum ambient temperature (T_A)
- Output current (I_{OUT})
- Output voltage (V_{OUT})
- Input voltage (V_{IN})
- Ground current (I_{GND})

First, calculate the power dissipation of the regulator from these numbers and the device parameters from this data sheet.

EQUATION 4-2:

$$P_D = (V_{IN} - V_{OUT}) \times I_{OUT} + V_{IN} \times I_{GND}$$

MIC69301/2/3

The ground current is approximated by using numbers from the [Electrical Characteristics](#) table or [Typical Performance Curves](#) section. The heat sink thermal resistance is then determined with this formula:

EQUATION 4-3:

$$\theta_{SA} = \left(\frac{T_{J(MAX)} - T_A}{P_D} \right) - (\theta_{JC} + \theta_{CS})$$

Where:

$T_{J(MAX)} \leq 125^{\circ}\text{C}$.

θ_{CS} = Between 0°C/W and 2°C/W .

The heat sink may be significantly reduced in applications where the minimum input voltage is known and is large compared with the dropout voltage. Use a series input resistor to drop excessive voltage and distribute the heat between this resistor and the regulator. The low dropout properties of Microchip Super β PNP regulators allow significant reductions in regulator power dissipation and the associated heat sink without compromising performance. When this technique is employed, a capacitor of at least $1.0 \mu\text{F}$ is needed directly between the input and regulator ground.

Refer to [Application Note 9](#) for further details and examples on thermal design and heat sink applications.

5.0 PACKAGING INFORMATION

5.1 Package Marking Information

5-Lead Adj. TO-263*



Example

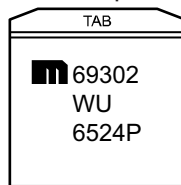

8-Lead Adj. SOIC*

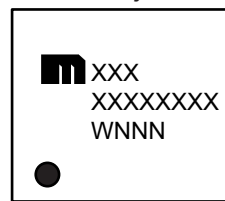

Example

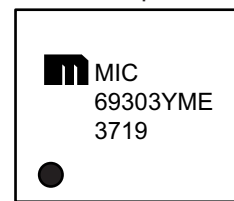

5-Lead Fixed TO-263*



Example

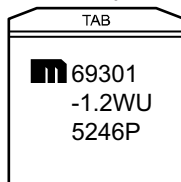

8-Lead Fixed SOIC*

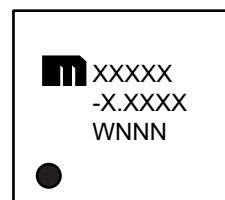

Example

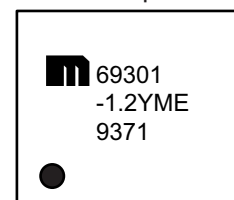

5-Lead Adj. S-PAK*

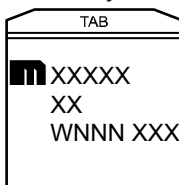

Example



12-Lead DFN*

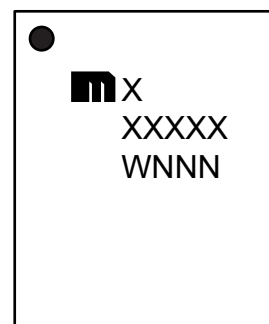

Example

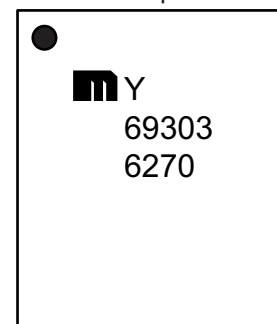

5-Lead Fixed S-PAK*

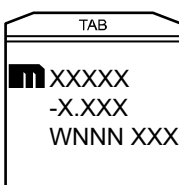

Example

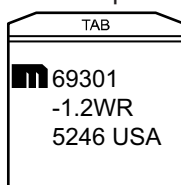

Legend:	XX...X	Product code or customer-specific information
	Y	Year code (last digit of calendar year)
	YY	Year code (last 2 digits of calendar year)
	WW	Week code (week of January 1 is week '01')
	NNN	Alphanumeric traceability code
	(e3)	Pb-free JEDEC® designator for Matte Tin (Sn)
	*	This package is Pb-free. The Pb-free JEDEC designator (e3) can be found on the outer packaging for this package.
	•, ▲, ▼	Pin one index is identified by a dot, delta up, or delta down (triangle mark).
Note:	In the event the full Microchip part number cannot be marked on one line, it will be carried over to the next line, thus limiting the number of available characters for customer-specific information. Package may or may not include the corporate logo.	
	Underbar (_) and/or Overbar (¯) symbol may not be to scale.	

MIC69301/2/3

5-Lead TO-263 Package Outline and Recommended Land Pattern

TITLE

5 LEAD T0263 PACKAGE OUTLINE & RECOMMENDED LAND PATTERN

DRAWING #	T0263-5LD-PL-1	UNIT	INCH/MM
------------------	----------------	-------------	---------

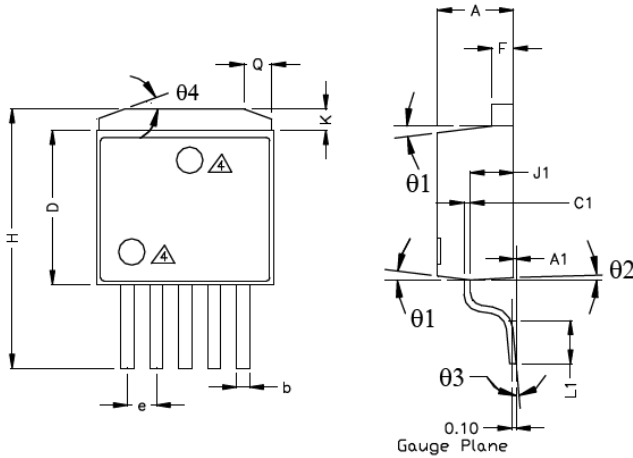

TOP VIEW

SIDE VIEW 1

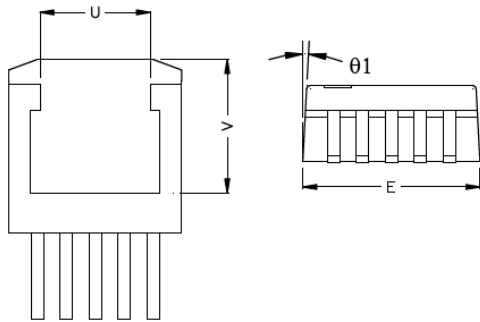

BOTTOM VIEW

SIDE VIEW 2

POS	INCH		MM	
	MIN	MAX	MIN	MAX
A	0.170	0.181	4.318	4.597
A1	0.000	0.012	0.000	0.305
b	0.026	0.036	0.660	0.914
C1	0.012	0.023	0.305	0.584
D	0.330	0.361	8.392	9.169
E	0.396	0.420	10.058	10.668
e	0.062	0.072	1.575	1.829
F	0.045	0.055	1.143	1.397
H	0.575	0.625	14.605	15.875
J1	0.080	0.120	2.032	3.048
K	0.045	0.066	1.143	1.676
L1	0.090	0.110	2.286	2.794
theta 1	3°	10°	3°	10°
theta 2	1°	7°	1°	7°
theta 3	0°	8°	0°	8°
theta 4	18°	22°	18°	22°
Q	0.055	0.075	1.397	1.905
U	0.256	Ref.	6.502	Ref.
V	0.305	Ref.	7.747	Ref.

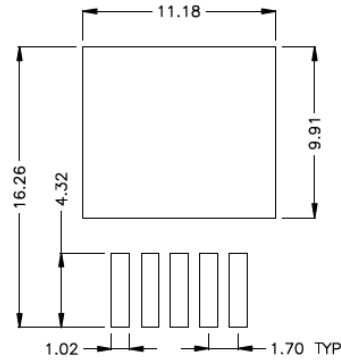

RECOMMENDED LAND PATTERN
(UNIT : mm)

- NOTE:
1. PACKAGE OUTLINE EXCLUSIVE OF MOLD FLASH & METAL BURR.
 2. PACKAGE OUTLINE INCLUSIVE OF PLATING THICKNESS.
 3. FOOT LENGTH USING GAUGE PLANE METHOD MEASUREMENT 0.010"
 4. PACKAGE TOP MARK MAY BE IN TOP CENTER OR LOWER LEFT CORNER
 5. ALL DIMENSIONS ARE IN INCHES/MILLIMETERS.

Note: For the most current package drawings, please see the Microchip Packaging Specification located at <http://www.microchip.com/packaging>.

5-Lead S-PAK Package Outline and Recommended Land Pattern

TITLE

5 LEAD SPAK PACKAGE OUTLINE & RECOMMENDED LAND PATTERN

DRAWING # SPAK-5LD-PL-1

UNIT MM

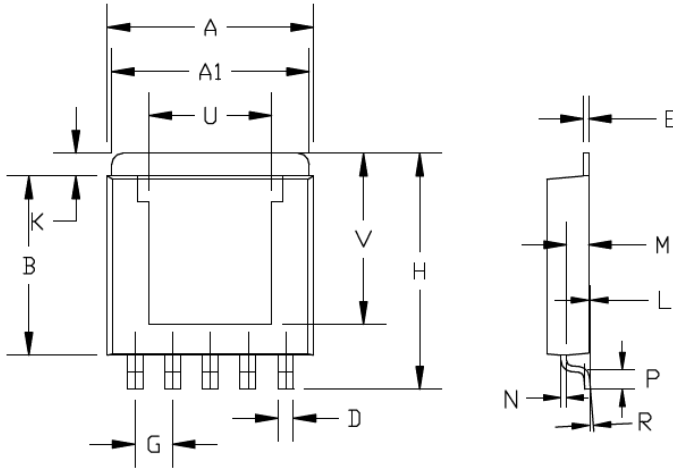

	INCHES		MILLIMETERS	
A	0.365	0.375	9.27	9.52
A1	0.350	0.360	8.89	9.14
B	0.310	0.320	7.87	8.13
C	0.070	0.080	1.78	2.03
D	0.025	0.031	0.63	0.79
E	0.010	BSC	0.25	BSC
G	0.067	BSC	1.70	BSC
H	0.410	0.420	10.41	10.67
K	0.030	0.050	0.76	1.27
L	0.001	0.005	0.03	0.13
M	0.035	0.045	0.89	1.14
N	0.010	BSC	0.25	BSC
P	0.031	0.041	0.79	1.04
R	0°	6°	0°	6°
U	0.220	BSC	5.58	BSC
V	0.296	BSC	7.52	BSC

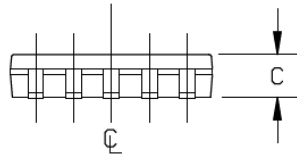

NOTE:

1. DIMENSION DOES NOT INCLUDE MOLD FLASH OR PROTRUSIONS.
2. DIMENSION INCLUDES PLATING THICKNESS. SOLDER MASK OPENING
3. RED CIRCLES IN LAND PATTERN REPRESENT THERMAL VIA, 0.30MM IN DIAMETER & SHOULD BE CONNECTED TO GND FOR MAXIMUM PERFORMANCE
4. GREEN RECTANGLES IN LAND PATTERN REPRESENT SOLDER STENCIL OPENING (OPTIONAL), 1.50X1.50MM.

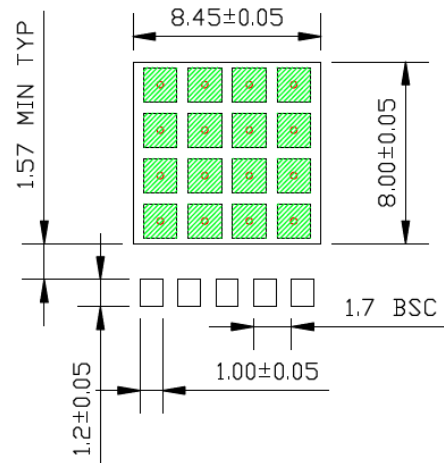

**RECOMMENDED
LAND PATTERN**

Note: For the most current package drawings, please see the Microchip Packaging Specification located at <http://www.microchip.com/packaging>.

MIC69301/2/3

8-Lead SOIC Package Outline and Recommended Land Pattern

8-Lead Small Outline Integrated Circuit Package (EQA) - 3.90 mm (1.50 In) Body [SOIC] With 3.10x2.41 mm Exposed Pad

Note: For the most current package drawings, please see the Microchip Packaging Specification located at <http://www.microchip.com/packaging>

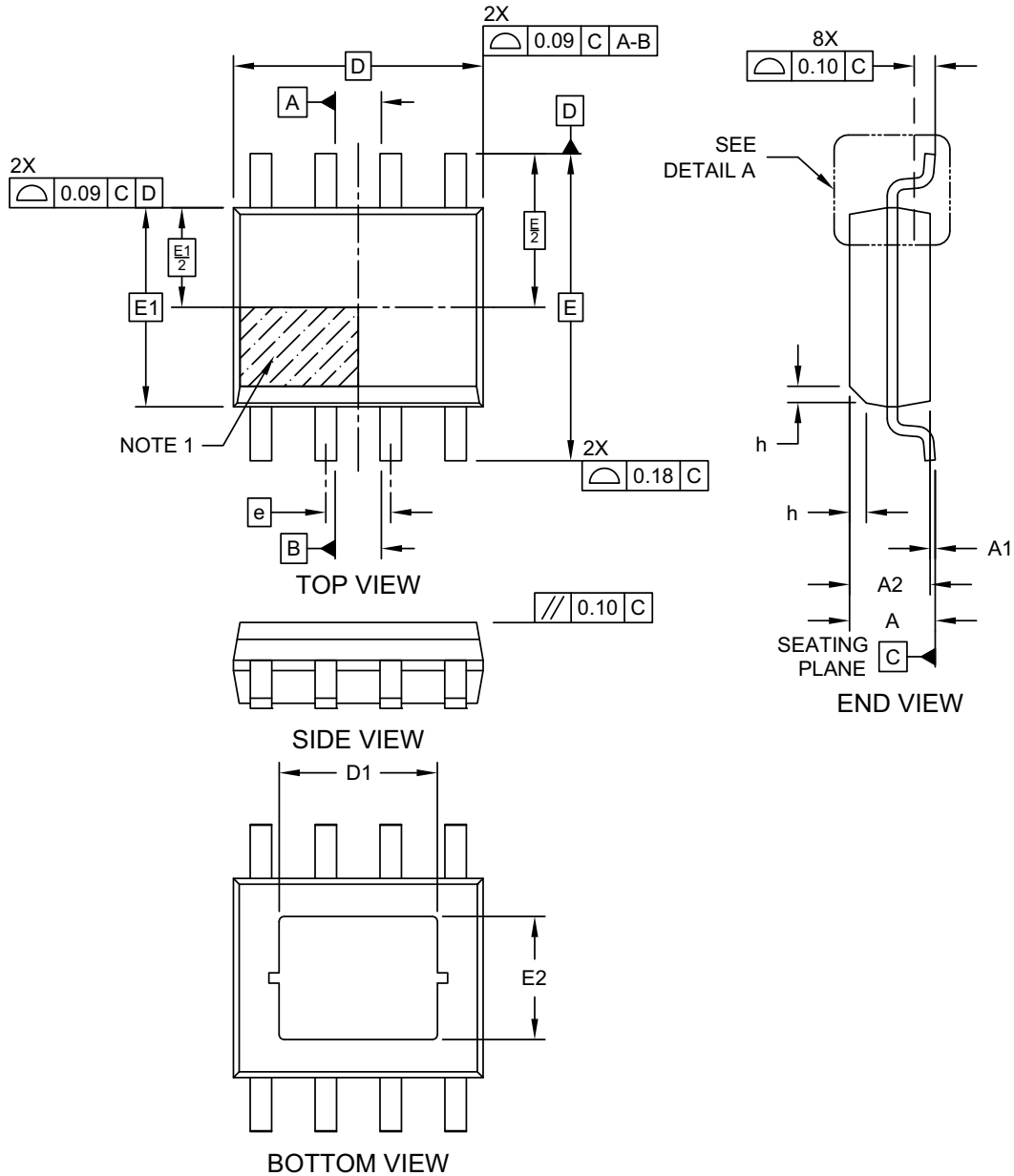

Microchip Technology Drawing C04-1136 Rev A Sheet 1 of 2

8-Lead Small Outline Integrated Circuit Package (EQA) - 3.90 mm (1.50 In) Body [SOIC] With 3.10x2.41 mm Exposed Pad

Note: For the most current package drawings, please see the Microchip Packaging Specification located at <http://www.microchip.com/packaging>

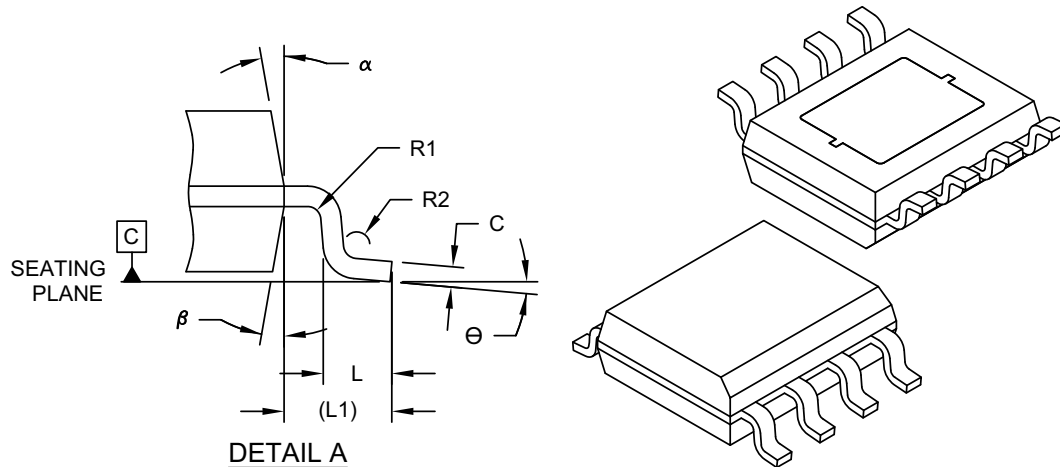

Dimension Limits	Units	MILLIMETERS		
		MIN	NOM	MAX
Number of Terminals	N	8		
Pitch	e	1.27 BSC		
Overall Height	A	1.43	1.55	1.68
Standoff	A1	0.00	0.05	0.10
Molded Package Thickness	A2	1.25	-	-
Overall Length	D	4.89 BSC		
Exposed Pad Length	D1	-	3.10	-
Overall Width	E	6.02 BSC		
Molded Package Width	E1	3.90 BSC		
Exposed Pad Width	E2	-	2.41	-
Terminal Width	b	0.35	0.41	0.49
Lead Thickness	c	0.19	0.20	0.25
Terminal Length	L	0.41	0.64	0.89
Terminal-to-Exposed-Pad	L1	1.04 REF		
Foot Angle	Θ	0°	5°	8°
Lead Bend Radius	R1	0.07	-	-
Terminal Length	R2	0.07	-	-
Mold Draft Angle	α	5°	-	15°
Mold Draft Angle	β	5°	-	15°

Notes:

- Pin 1 visual index feature may vary, but must be located within the hatched area.
- Package is saw singulated
- Dimensioning and tolerancing per ASME Y14.5M
 BSC: Basic Dimension. Theoretically exact value shown without tolerances.
 REF: Reference Dimension, usually without tolerance, for information purposes only.

Microchip Technology Drawing C04-1136 Rev A Sheet 2 of 2

MIC69301/2/3

8-Lead Small Outline Integrated Circuit Package (EQA) - 3.90 mm (1.50 In) Body [SOIC] With 3.10x2.41 mm Exposed Pad

Note: For the most current package drawings, please see the Microchip Packaging Specification located at <http://www.microchip.com/packaging>

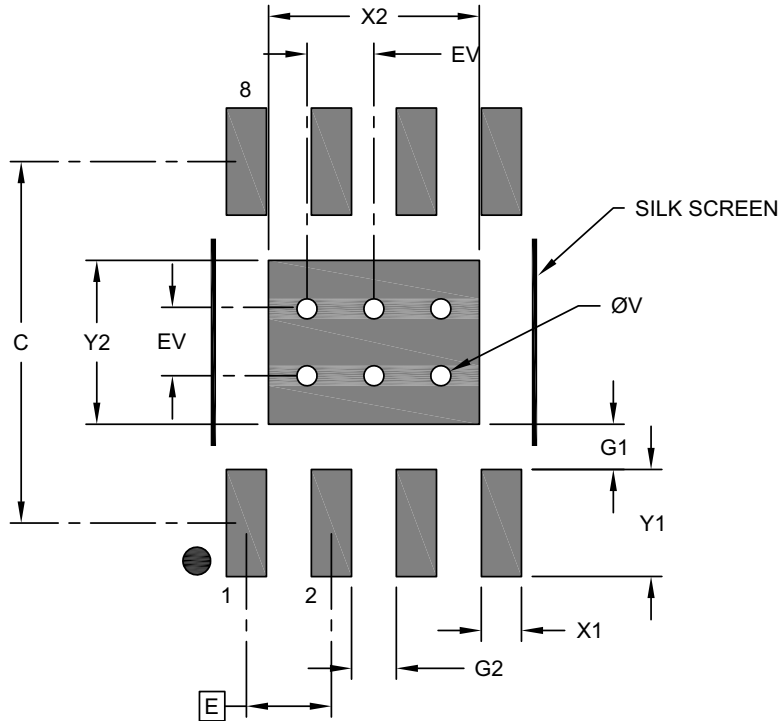

RECOMMENDED LAND PATTERN

Dimension Limits	Units	MILLIMETERS		
		MIN	NOM	MAX
Contact Pitch	E	1.27 BSC		
Optional Center Pad Width	X2			3.15
Optional Center Pad Length	Y2			2.45
Contact Pad Spacing	C		5.40	
Contact Pad Width (X8)	X1			0.60
Contact Pad Length (X8)	Y1			1.60
Contact Pad to Center Pad (X8)	G1	0.68		
Contact Pad to Contact Pad (X6)	G2	0.67		
Thermal Via Diameter	V		0.30	
Thermal Via Pitch	EV		1.00	

Notes:

- Dimensioning and tolerancing per ASME Y14.5M
BSC: Basic Dimension. Theoretically exact value shown without tolerances.
- For best soldering results, thermal vias, if used, should be filled or tented to avoid solder loss during reflow process

Microchip Technology Drawing C04-1136 Rev A

12-Lead DFN 4 mm x 4 mm Package Outline and Recommended Land Pattern

TITLE

12 LEAD DFN 4.0 x 4.0 mm PACKAGE OUTLINE & RECOMMENDED LAND PATTERN

DRAWING #	DFN44-12LD-PL-1	UNIT	MM
-----------	-----------------	------	----

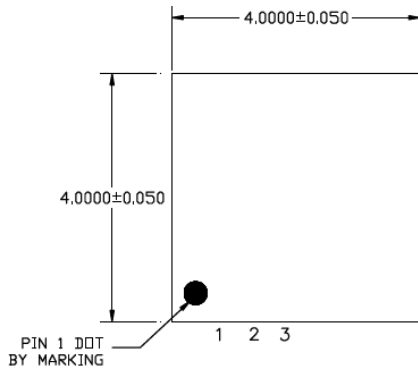

TOP VIEW

NOTE: 1, 2, 3

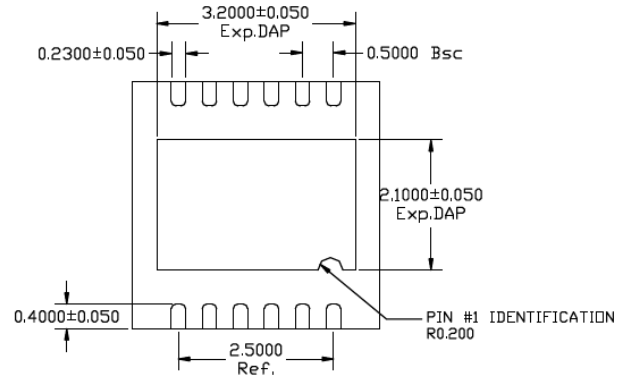

BOTTOM VIEW

NOTE: 1, 2

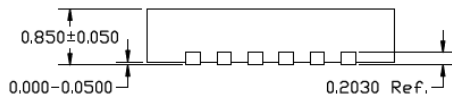

SIDE VIEW

NOTE: 1, 2

NOTE:

1. MAX PACKAGE WARPAGE IS 0.05MM
2. MAX ALLOWABLE BURR IS 0.076MM IN ALL DIRECTIONS
3. PIN #1 IS ON TOP WILL BE LASER MARKED
4. GREEN RECTANGLES (SHADED AREA) REPRESENT STENCIL OPENING ON EXPOSED AREA. SIZE IS 0.85X0.87 MM, 1.07 MM PITCH SPACING
5. RED CIRCLES REPRESENT THERMAL VIAS & SHOULD BE CONNECTED TO GND FOR MAX PERFORMANCE. 0.30 - 0.35 MM RECOMMENDED DIAMETER, 1.0MM PITCH SPACING

Note: For the most current package drawings, please see the Microchip Packaging Specification located at <http://www.microchip.com/packaging>.

MIC69301/2/3

POD-Land Pattern drawing # DFN44-12LD-PL-1

RECOMMENDED LAND PATTERN

NOTE: 4, 5

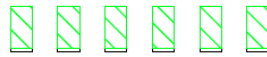
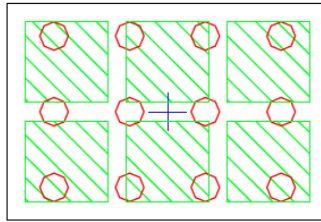
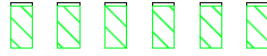

STACKED-UP

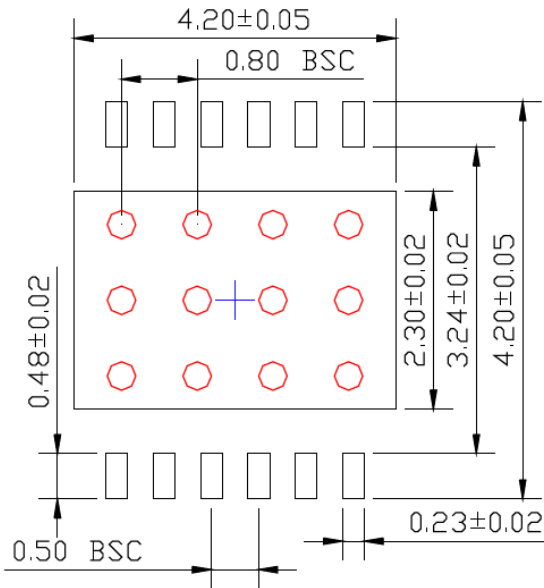

EXPOSED METAL TRACE

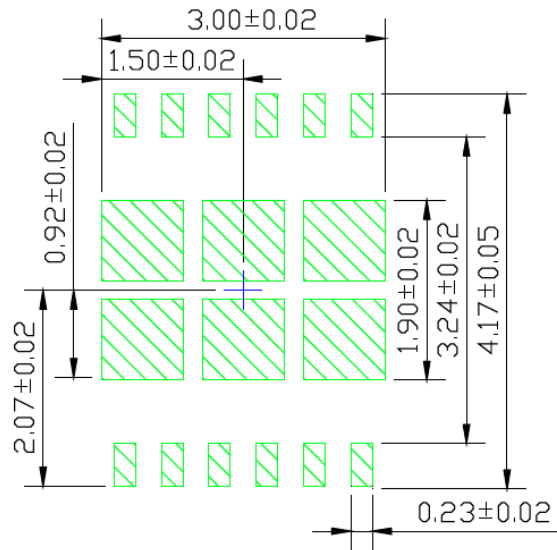

SOLDER STENCIL OPENING

Note: For the most current package drawings, please see the Microchip Packaging Specification located at <http://www.microchip.com/packaging>.

APPENDIX A: REVISION HISTORY

Revision A (December 2021)

- Converted Micrel document MIC69301/2/3 to Microchip data sheet template DS20006625A.
- Minor grammatical text changes throughout.

MIC69301/2/3

NOTES:

PRODUCT IDENTIFICATION SYSTEM

To order or obtain information, e.g., on pricing or delivery, contact your local Microchip representative or sales office.

<u>Device</u>	<u>-X.X</u>	<u>X</u>	<u>XX</u>	<u>-XX</u>	Examples:
Part No.	Output Voltage	Junction Temp. Range	Package	Media Type	
Device:	MIC69301:	Single Supply V_{IN} , Low V_{IN} , Low V_{OUT} , 3A LDO with Error Flag Output			a) MIC69301-1.2WU: MIC69301, 1.2V Output Voltage, -40°C to $+125^{\circ}\text{C}$ Temperature Range, 5-Lead TO-263, 50/Tube
	MIC69302:	Single Supply V_{IN} , Low V_{IN} , Low V_{OUT} , 3A LDO			b) MIC69301-1.2WU-TR: MIC69301, 1.2V Output Voltage, -40°C to $+125^{\circ}\text{C}$ Temperature Range, 5-Lead TO-263, 750/Reel
	MIC69303:	Single Supply V_{IN} , Low V_{IN} , Low V_{OUT} , 3A LDO with Error Flag Output			c) MIC69301-1.2WR: MIC69301, 1.2V Output Voltage, -40°C to $+125^{\circ}\text{C}$ Temperature Range, 5-Lead S-PAK, 48/Tube
Output Voltage:	<blank>=	Adjustable			d) MIC69301-1.2WR-TR: MIC69301, 1.2V Output Voltage, -40°C to $+125^{\circ}\text{C}$ Temperature Range, 5-Lead S-PAK, 750/Reel
	1.2 =	1.2V			e) MIC69301-1.2YME-TR: MIC69301, 1.2V Output Voltage, -40°C to $+125^{\circ}\text{C}$ Temperature Range, 8-Lead SOIC, 2,500/Reel
Junction Temperature Range:	Y =	-40°C to $+125^{\circ}\text{C}$, RoHS-Compliant			f) MIC69302WU: MIC69302, Adjustable Output Voltage, -40°C to $+125^{\circ}\text{C}$ Temperature Range, 5-Lead TO-263, 50/Tube
Package:	WU =	5-Lead TO-263			g) MIC69302WU-TR: MIC69302, Adjustable Output Voltage, -40°C to $+125^{\circ}\text{C}$ Temperature Range, 5-Lead TO-263, 750/Reel
	WR =	5-Lead S-PAK			h) MIC69302WR: MIC69302, Adjustable Output Voltage, -40°C to $+125^{\circ}\text{C}$ Temperature Range, 5-Lead S-PAK, 48/Tube
	ME =	8-Lead ePad SOIC			i) MIC69302WR-TR: MIC69302, Adjustable Output Voltage, -40°C to $+125^{\circ}\text{C}$ Temperature Range, 5-Lead S-PAK, 750/Reel
	ML =	12-Lead 4 mm x 4 mm DFN			j) MIC69303YME-TR: MIC69303, Adjustable Output Voltage, -40°C to $+125^{\circ}\text{C}$ Temperature Range, 8-Lead SOIC, 2,500/Reel
Media Type:	<blank>=	48/Tube (WR Package option)			k) MIC69303YML-TR: MIC69303, Adjustable Output Voltage, -40°C to $+125^{\circ}\text{C}$ Temperature Range, 12-Lead DFN, 5,000/Reel
	<blank>=	50/Tube (WU Package option)			
	TR =	750/Reel (WR & WU Package options)			
	TR =	2,500/Reel (ME Package option)			
	TR =	5,000/Reel (ML Package option)			
					Note 1: Tape and Reel identifier only appears in the catalog part number description. This identifier is used for ordering purposes and is not printed on the device package. Check with your Microchip Sales Office for package availability with the Tape and Reel option.

MIC69301/2/3

NOTES:

Note the following details of the code protection feature on Microchip products:

- Microchip products meet the specifications contained in their particular Microchip Data Sheet.
- Microchip believes that its family of products is secure when used in the intended manner, within operating specifications, and under normal conditions.
- Microchip values and aggressively protects its intellectual property rights. Attempts to breach the code protection features of Microchip product is strictly prohibited and may violate the Digital Millennium Copyright Act.
- Neither Microchip nor any other semiconductor manufacturer can guarantee the security of its code. Code protection does not mean that we are guaranteeing the product is “unbreakable”. Code protection is constantly evolving. Microchip is committed to continuously improving the code protection features of our products.

This publication and the information herein may be used only with Microchip products, including to design, test, and integrate Microchip products with your application. Use of this information in any other manner violates these terms. Information regarding device applications is provided only for your convenience and may be superseded by updates. It is your responsibility to ensure that your application meets with your specifications. Contact your local Microchip sales office for additional support or, obtain additional support at <https://www.microchip.com/en-us/support/design-help/client-support-services>.

THIS INFORMATION IS PROVIDED BY MICROCHIP "AS IS". MICROCHIP MAKES NO REPRESENTATIONS OR WARRANTIES OF ANY KIND WHETHER EXPRESS OR IMPLIED, WRITTEN OR ORAL, STATUTORY OR OTHERWISE, RELATED TO THE INFORMATION INCLUDING BUT NOT LIMITED TO ANY IMPLIED WARRANTIES OF NON-INFRINGEMENT, MERCHANTABILITY, AND FITNESS FOR A PARTICULAR PURPOSE, OR WARRANTIES RELATED TO ITS CONDITION, QUALITY, OR PERFORMANCE.

IN NO EVENT WILL MICROCHIP BE LIABLE FOR ANY INDIRECT, SPECIAL, PUNITIVE, INCIDENTAL, OR CONSEQUENTIAL LOSS, DAMAGE, COST, OR EXPENSE OF ANY KIND WHATSOEVER RELATED TO THE INFORMATION OR ITS USE, HOWEVER CAUSED, EVEN IF MICROCHIP HAS BEEN ADVISED OF THE POSSIBILITY OR THE DAMAGES ARE FORESEEABLE. TO THE FULLEST EXTENT ALLOWED BY LAW, MICROCHIP'S TOTAL LIABILITY ON ALL CLAIMS IN ANY WAY RELATED TO THE INFORMATION OR ITS USE WILL NOT EXCEED THE AMOUNT OF FEES, IF ANY, THAT YOU HAVE PAID DIRECTLY TO MICROCHIP FOR THE INFORMATION.

Use of Microchip devices in life support and/or safety applications is entirely at the buyer's risk, and the buyer agrees to defend, indemnify and hold harmless Microchip from any and all damages, claims, suits, or expenses resulting from such use. No licenses are conveyed, implicitly or otherwise, under any Microchip intellectual property rights unless otherwise stated.

For information regarding Microchip's Quality Management Systems, please visit www.microchip.com/quality.

Trademarks

The Microchip name and logo, the Microchip logo, Adaptec, AnyRate, AVR, AVR logo, AVR Freaks, BesTime, BitCloud, CryptoMemory, CryptoRF, dsPIC, flexPWR, HELDO, IGLOO, JukeBlox, KeeLoq, Kleer, LANCheck, LinkMD, maXStylus, maXTouch, MediaLB, megaAVR, Microsemi, Microsemi logo, MOST, MOST logo, MPLAB, OptoLyzer, PIC, picoPower, PICSTART, PIC32 logo, PolarFire, Prochip Designer, QTouch, SAM-BA, SenGenuity, SpyNIC, SST, SST Logo, SuperFlash, Symmetricom, SyncServer, Tachyon, TimeSource, tinyAVR, UNI/O, Vectron, and XMEGA are registered trademarks of Microchip Technology Incorporated in the U.S.A. and other countries.

AgileSwitch, APT, ClockWorks, The Embedded Control Solutions Company, EtherSynch, Flashtec, Hyper Speed Control, HyperLight Load, IntelliMOS, Libero, motorBench, mTouch, Powermite 3, Precision Edge, ProASIC, ProASIC Plus, ProASIC Plus logo, QuietWire, SmartFusion, SyncWorld, Temux, TimeCesium, TimeHub, TimePictra, TimeProvider, TrueTime, WinPath, and ZL are registered trademarks of Microchip Technology Incorporated in the U.S.A.

Adjacent Key Suppression, AKS, Analog-for-the-Digital Age, Any Capacitor, AnyIn, AnyOut, Augmented Switching, BlueSky, BodyCom, CodeGuard, CryptoAuthentication, CryptoAutomotive, CryptoCompanion, CryptoController, dsPICDEM, dsPICDEM.net, Dynamic Average Matching, DAM, ECAN, Espresso T1S, EtherGREEN, GridTime, IdealBridge, In-Circuit Serial Programming, ICSP, INICnet, Intelligent Paralleling, Inter-Chip Connectivity, JitterBlocker, Knob-on-Display, maxCrypto, maxView, memBrain, Mindi, MiWi, MPASM, MPF, MPLAB Certified logo, MPLIB, MPLINK, MultiTRAK, NetDetach, NVM Express, NVMe, Omniscient Code Generation, PICDEM, PICDEM.net, PICkit, PICtail, PowerSmart, PureSilicon, QMatrix, REAL ICE, Ripple Blocker, RTAX, RTG4, SAM-ICE, Serial Quad I/O, simpleMAP, SimpliPHY, SmartBuffer, SmartHLS, SMART-I.S., storClad, SQI, SuperSwitcher, SuperSwitcher II, Switchtec, SynchroPHY, Total Endurance, TSHARC, USBCheck, VariSense, VectorBlox, VeriPHY, ViewSpan, WiperLock, XpressConnect, and ZENA are trademarks of Microchip Technology Incorporated in the U.S.A. and other countries.

SQTP is a service mark of Microchip Technology Incorporated in the U.S.A.

The Adaptec logo, Frequency on Demand, Silicon Storage Technology, Symmcom, and Trusted Time are registered trademarks of Microchip Technology Inc. in other countries.

GestIC is a registered trademark of Microchip Technology Germany II GmbH & Co. KG, a subsidiary of Microchip Technology Inc., in other countries.

All other trademarks mentioned herein are property of their respective companies.

© 2021, Microchip Technology Incorporated and its subsidiaries.

All Rights Reserved.

ISBN: 978-1-5224-9435-5



MICROCHIP

Worldwide Sales and Service

AMERICAS

Corporate Office
2355 West Chandler Blvd.
Chandler, AZ 85224-6199
Tel: 480-792-7200
Fax: 480-792-7277
Technical Support:
[http://www.microchip.com/
support](http://www.microchip.com/support)
Web Address:
www.microchip.com

Atlanta

Duluth, GA
Tel: 678-957-9614
Fax: 678-957-1455

Austin, TX

Tel: 512-257-3370

Boston

Westborough, MA
Tel: 774-760-0087
Fax: 774-760-0088

Chicago

Itasca, IL
Tel: 630-285-0071
Fax: 630-285-0075

Dallas

Addison, TX
Tel: 972-818-7423
Fax: 972-818-2924

Detroit

Novi, MI
Tel: 248-848-4000

Houston, TX

Tel: 281-894-5983

Indianapolis

Noblesville, IN
Tel: 317-773-8323
Fax: 317-773-5453
Tel: 317-536-2380

Los Angeles

Mission Viejo, CA
Tel: 949-462-9523
Fax: 949-462-9608
Tel: 951-273-7800

Raleigh, NC

Tel: 919-844-7510

New York, NY

Tel: 631-435-6000

San Jose, CA

Tel: 408-735-9110
Tel: 408-436-4270

Canada - Toronto

Tel: 905-695-1980
Fax: 905-695-2078

ASIA/PACIFIC

Australia - Sydney
Tel: 61-2-9868-6733

China - Beijing
Tel: 86-10-8569-7000

China - Chengdu
Tel: 86-28-8665-5511

China - Chongqing
Tel: 86-23-8980-9588

China - Dongguan
Tel: 86-769-8702-9880

China - Guangzhou
Tel: 86-20-8755-8029

China - Hangzhou
Tel: 86-571-8792-8115

China - Hong Kong SAR
Tel: 852-2943-5100

China - Nanjing
Tel: 86-25-8473-2460

China - Qingdao
Tel: 86-532-8502-7355

China - Shanghai
Tel: 86-21-3326-8000

China - Shenyang
Tel: 86-24-2334-2829

China - Shenzhen
Tel: 86-755-8864-2200

China - Suzhou
Tel: 86-186-6233-1526

China - Wuhan
Tel: 86-27-5980-5300

China - Xian
Tel: 86-29-8833-7252

China - Xiamen
Tel: 86-592-2388138

China - Zhuhai
Tel: 86-756-3210040

ASIA/PACIFIC

India - Bangalore
Tel: 91-80-3090-4444

India - New Delhi
Tel: 91-11-4160-8631

India - Pune
Tel: 91-20-4121-0141

Japan - Osaka
Tel: 81-6-6152-7160

Japan - Tokyo
Tel: 81-3-6880-3770

Korea - Daegu
Tel: 82-53-744-4301

Korea - Seoul
Tel: 82-2-554-7200

Malaysia - Kuala Lumpur
Tel: 60-3-7651-7906

Malaysia - Penang
Tel: 60-4-227-8870

Philippines - Manila
Tel: 63-2-634-9065

Singapore
Tel: 65-6334-8870

Taiwan - Hsin Chu
Tel: 886-3-577-8366

Taiwan - Kaohsiung
Tel: 886-7-213-7830

Taiwan - Taipei
Tel: 886-2-2508-8600

Thailand - Bangkok
Tel: 66-2-694-1351

Vietnam - Ho Chi Minh
Tel: 84-28-5448-2100

EUROPE

Austria - Wels
Tel: 43-7242-2244-39
Fax: 43-7242-2244-393

Denmark - Copenhagen
Tel: 45-4485-5910
Fax: 45-4485-2829

Finland - Espoo
Tel: 358-9-4520-820

France - Paris
Tel: 33-1-69-53-63-20
Fax: 33-1-69-30-90-79

Germany - Garching
Tel: 49-8931-9700

Germany - Haan
Tel: 49-2129-3766400

Germany - Heilbronn
Tel: 49-7131-72400

Germany - Karlsruhe
Tel: 49-721-625370

Germany - Munich
Tel: 49-89-627-144-0
Fax: 49-89-627-144-44

Germany - Rosenheim
Tel: 49-8031-354-560

Israel - Ra'anana
Tel: 972-9-744-7705

Italy - Milan
Tel: 39-0331-742611
Fax: 39-0331-466781

Italy - Padova
Tel: 39-049-7625286

Netherlands - Drunen
Tel: 31-416-690399
Fax: 31-416-690340

Norway - Trondheim
Tel: 47-7288-4388

Poland - Warsaw
Tel: 48-22-3325737

Romania - Bucharest
Tel: 40-21-407-87-50

Spain - Madrid
Tel: 34-91-708-08-90
Fax: 34-91-708-08-91

Sweden - Gothenberg
Tel: 46-31-704-60-40

Sweden - Stockholm
Tel: 46-8-5090-4654

UK - Wokingham
Tel: 44-118-921-5800
Fax: 44-118-921-5820