

Specification

Part No.	:	MGA1.101111
Product Name	:	NB-IoT / CAT M1 3dBi Mini Magnetic Mount 698~960MHz/1710~2700MHz
Features	:	698MHz to 960MHz and 1710MHz to 2700MHz Works on 4G/3G/2G Typical 30%+ Efficiency and 3dBi Peak Gain Robust High Strength Super Magnet Mount Cable: 1M RG174 Connector: SMA(M) Dimensions: 82.8*30*7.8mm RoHS compliant



1. Introduction

The MGA1.101111 magnetic mount antenna delivers stable high omnidirectional gain and efficiencies to support NB-IoT / CAT M1 application bands and all common 4G/3G/2G global cellular bands from 698 MHz to 2.7 GHz.

NB-IoT / CAT M1 is a low power wide area (LPWA) technology specifically designed for IoT and M2M. CAT M1 technology offers lower maintenance cost, with greater efficiency and reliability by reducing power consumption and providing deeper penetration compared to standard cellular technologies. It operates on secure mobile networks making it suited to automotive, smart meter, medical and smart city applications.

This high performing antenna can be used for all cellular devices and will not require changing antennas when deploying from country to country or technology to technology like CDMA to GSM. Being magnetic mount it is designed to be mounted on a ground plane for optimal performance. A reliable return loss of < 5dB when mounted on a metal plate ensures it complies with the industry standards set by module makers and networks worldwide. Taoglas recommends using the antenna with 1m cable length or less and can provide customized connectors and cable lengths upon customer requirements.

The strong magnet base is extremely stable and robust, using only high quality neodymium magnets for a secure magnetic mount to ensure a high pull force to disengage.

2. Specification

CAT M1						
Frequency(MHz)	Band 2		Band 4		Band 12	
	Tx	Rx	Tx	Rx	Tx	Rx
	1850-1910	1930-1990	1710-1755	2110-2155	699-716	729-746
Efficiency (%)						
Free Space	52.24	54.24	41.81	59.85	36.41	24.22
30x30cm Ground Center	44.72	50.07	32.23	59.94	51.57	63.02
Average Gain (dBi)						
Free Space	-2.82	-2.66	-3.79	-2.23	-4.39	-5.73
30x30cm Ground Center	-3.50	-3.01	-4.87	-2.22	-2.87	-2.00
Peak Gain (dBi)						
Free Space	1.33	1.56	0.13	1.57	-0.83	-0.93
30x30cm Ground Center	2.37	3.07	0.32	3.39	0.02	1.12
Impedance	50Ω					
Polarization	Linear					
Cable	1 Meter RG-174 Coaxial Cable					
Connector	SMA (M)					
MECHNICAL						
Antenna Dimension	7.8 x 30 x 82.8 mm					
Housing Material	TPEE and ABS					
Cable	1 Meter RG-174 Coaxial Cable					
Connector	SMA (M)					
Magnetic Pull Force	2 kgf					

3. Antenna Characteristics

3.1. Antenna Test Setup

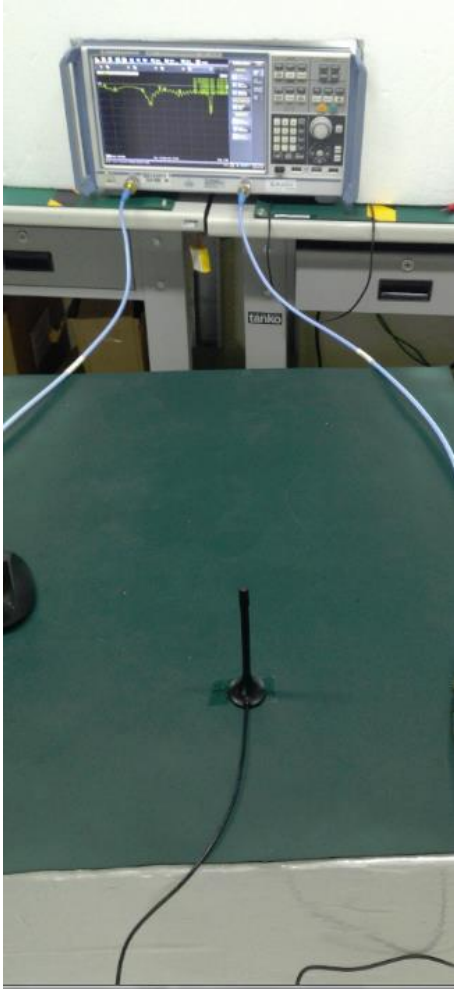

In free space

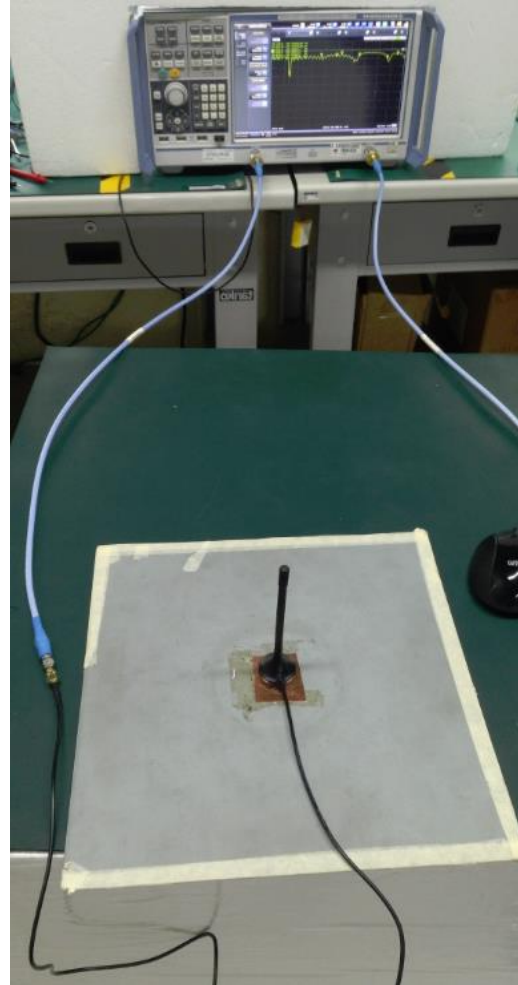

On 30x30cm Ground Center

3.2. Return Loss

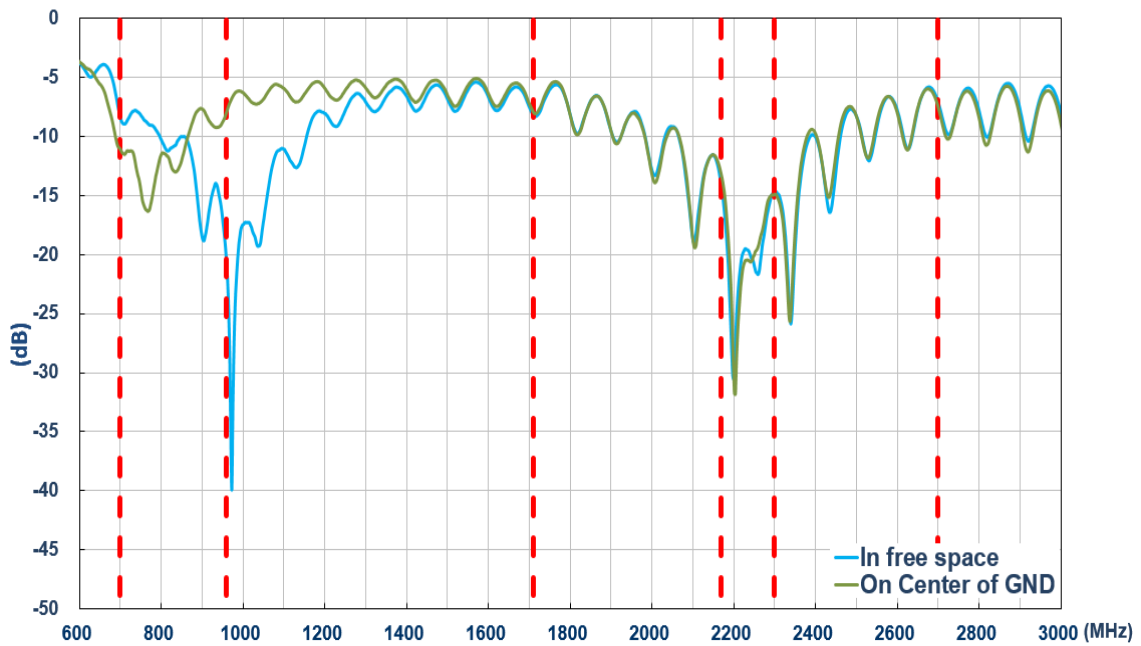

3.3. Efficiency

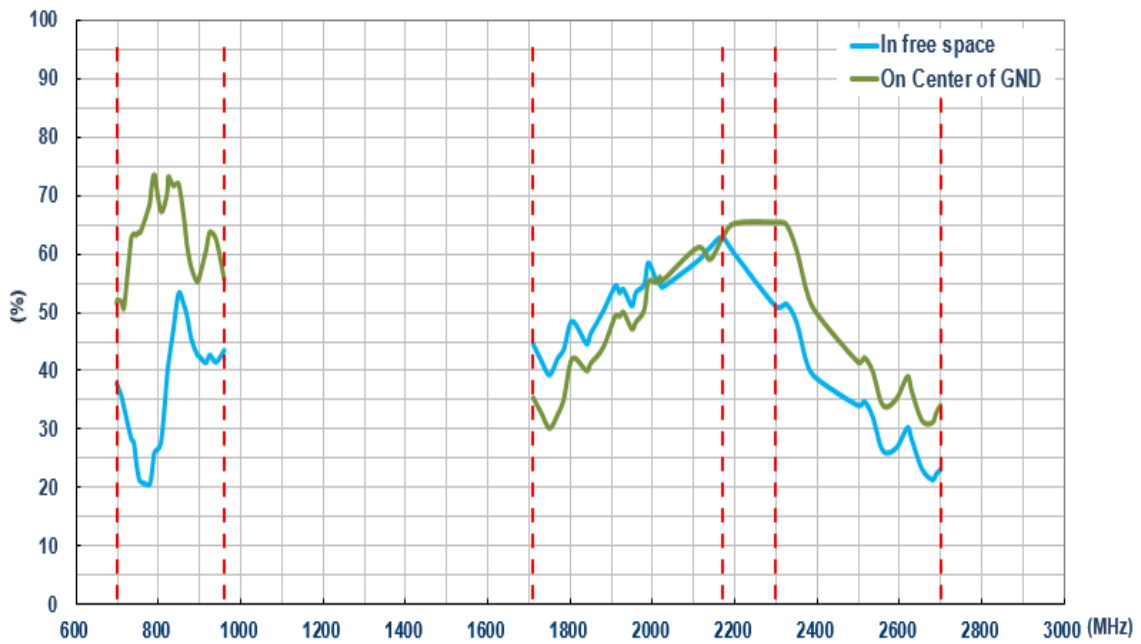

3.4. Peak Gain

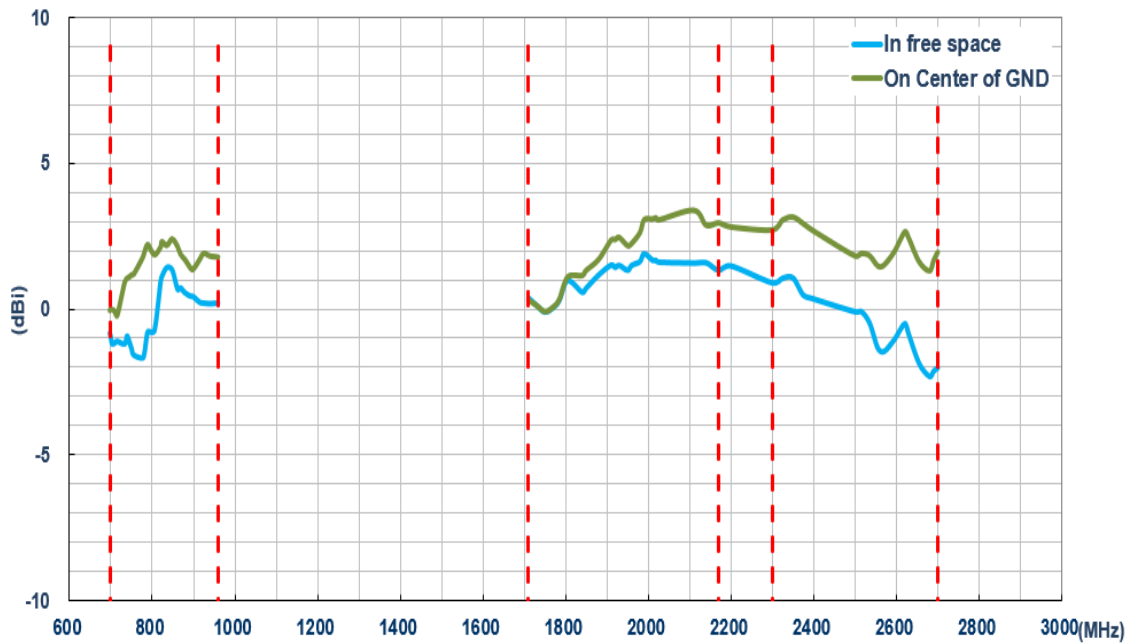

3.5. Average Gain

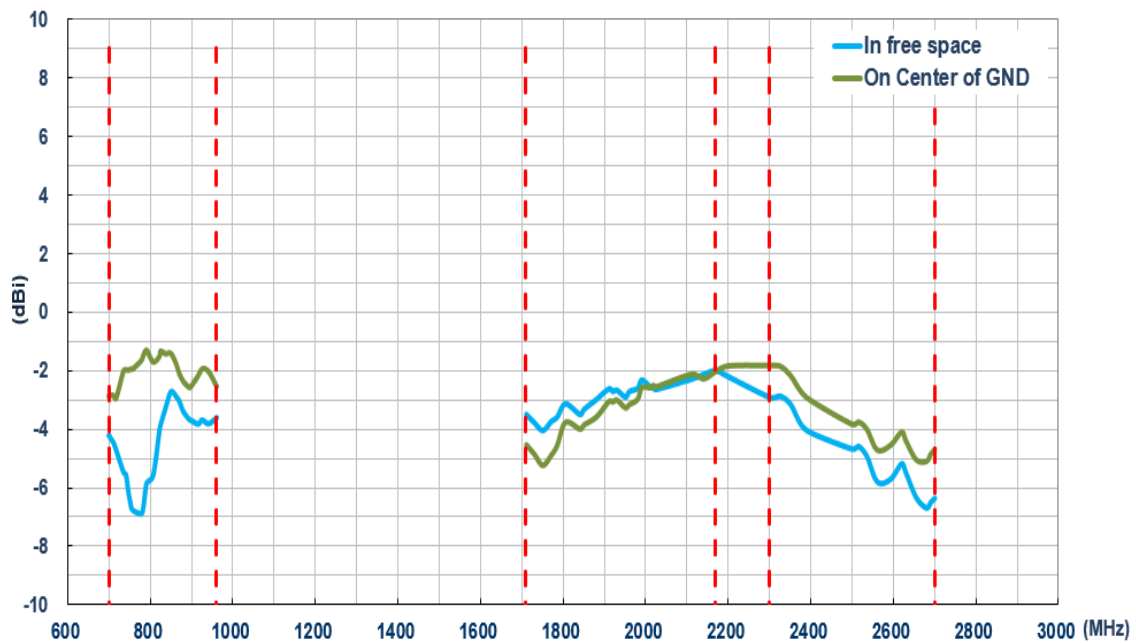

4. Antenna Radiation Patterns

4.1. Antenna Setup (Antenna testing Setup in Anechoic Chamber)



In free space

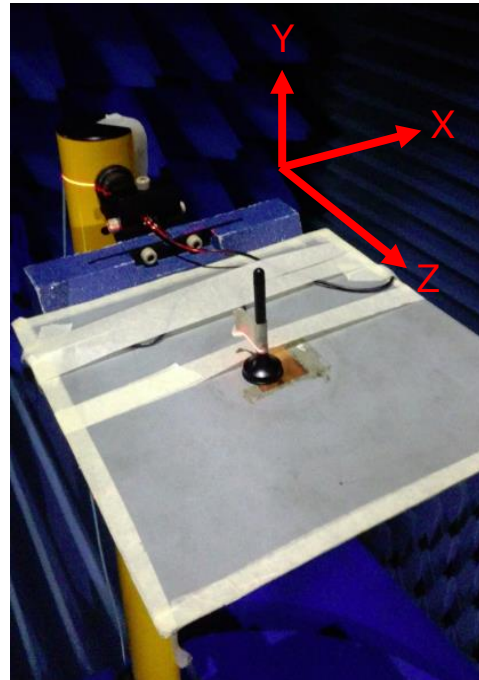

On 30x30 Ground Center

4.2. 2D Radiation Patterns

4.2.1. In free space

XY Plane

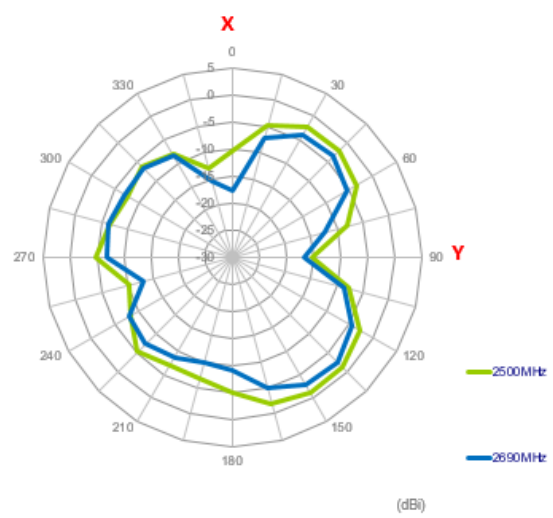
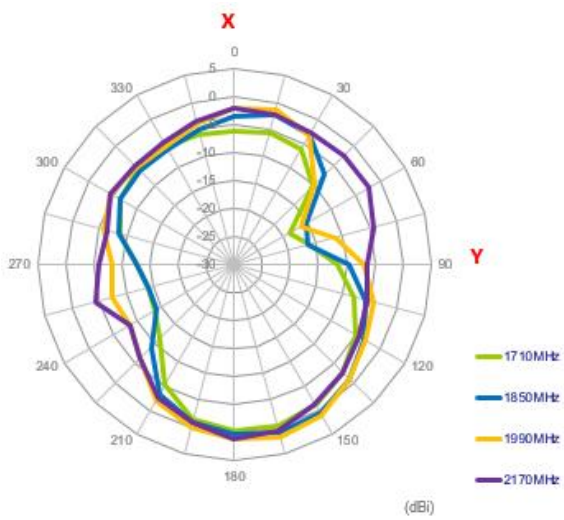
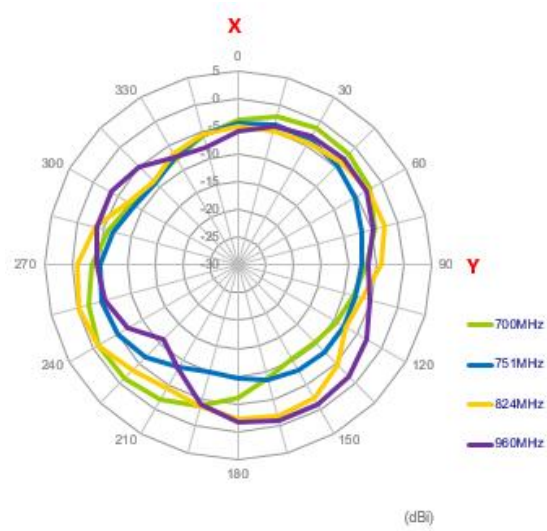

XZ Plane

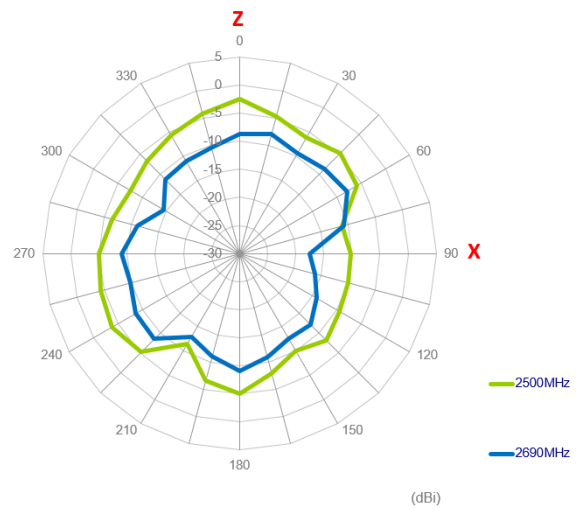
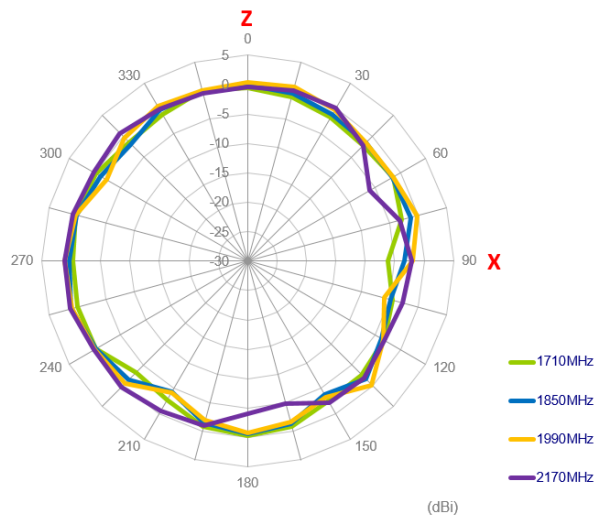
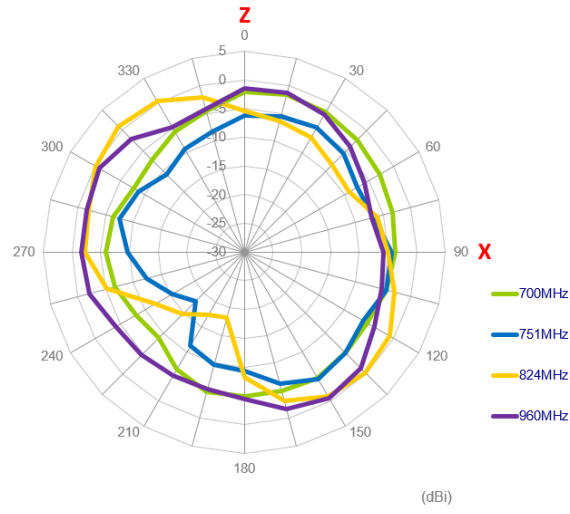

YZ Plane

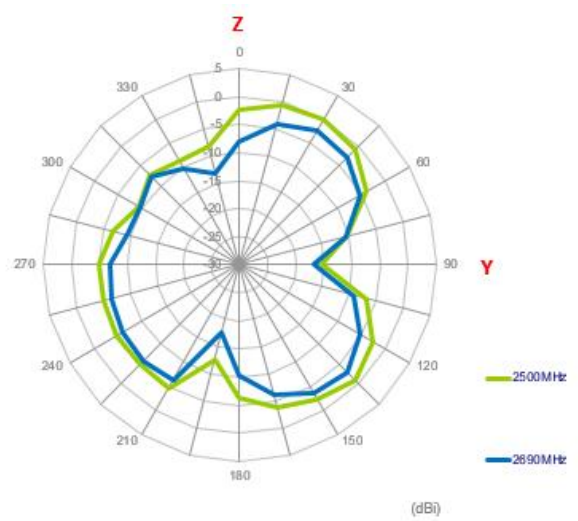
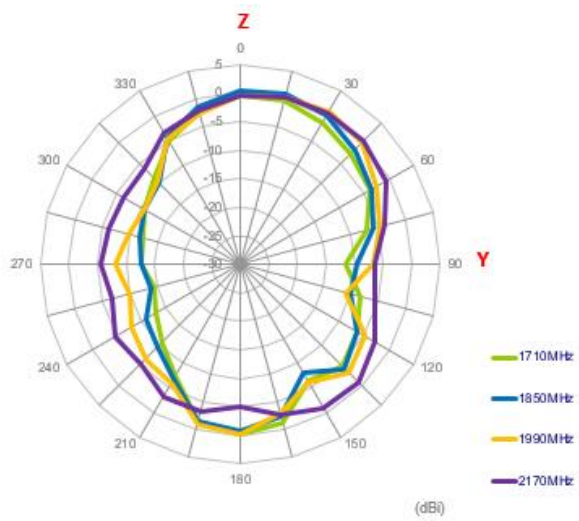
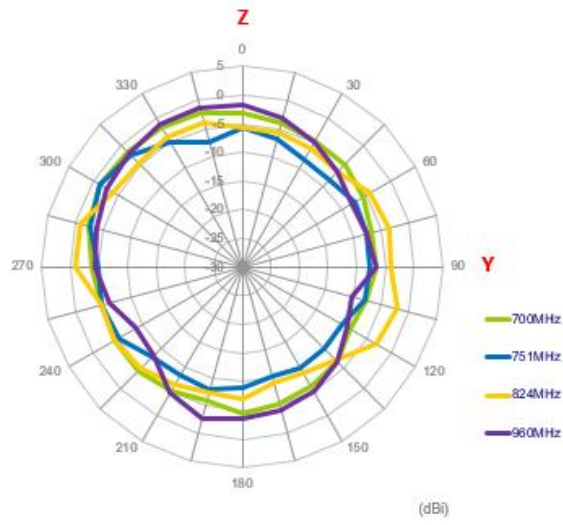

4.2.2. On the 30x30cm Ground Center

XY Plane

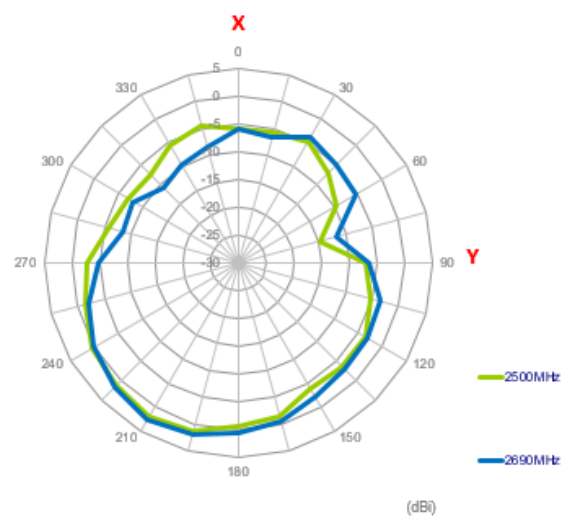
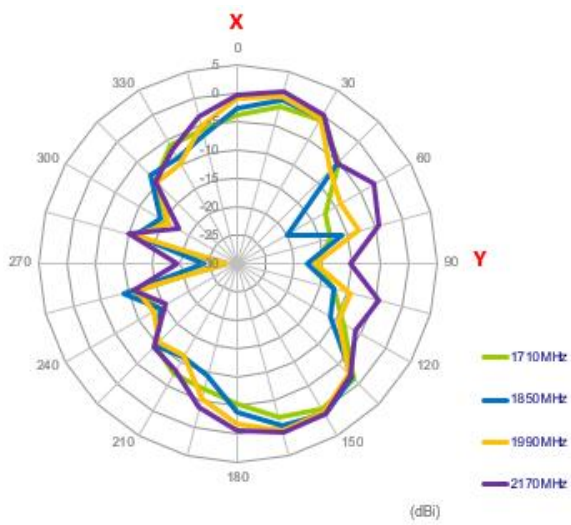
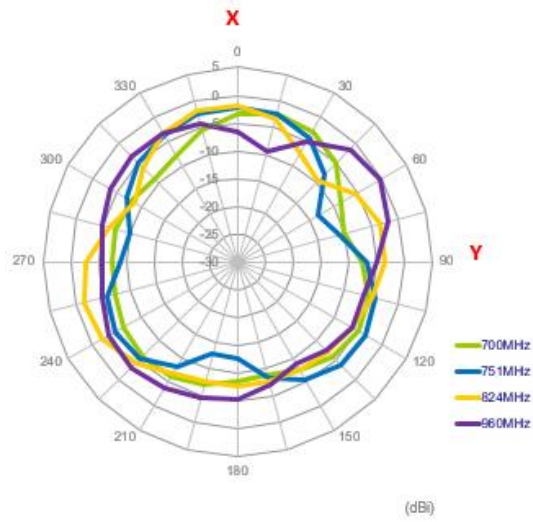

XZ Plane

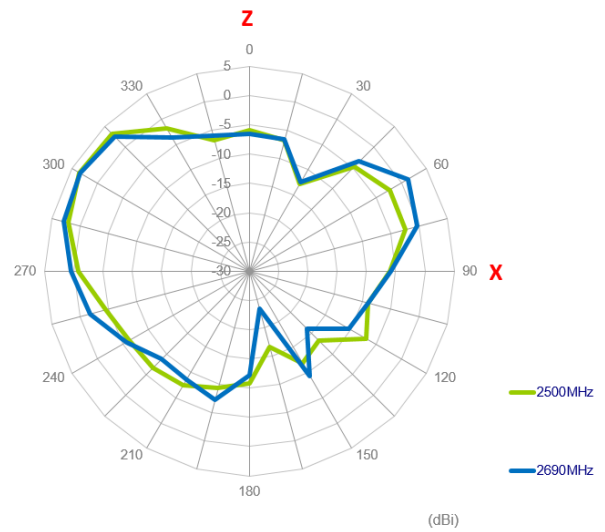
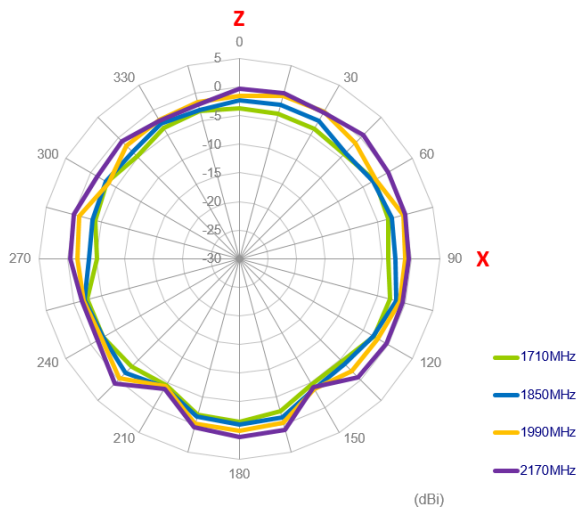
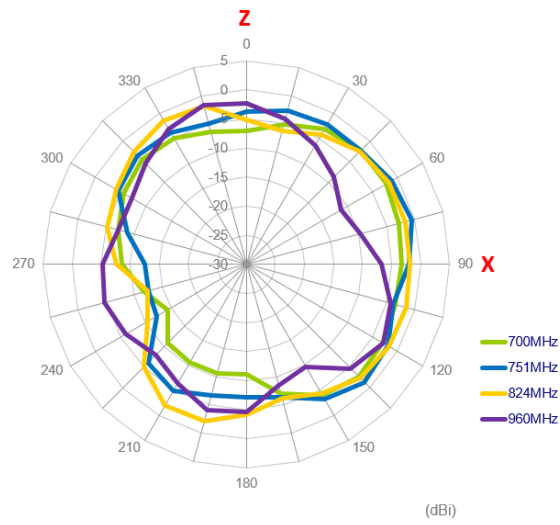

YZ Plane

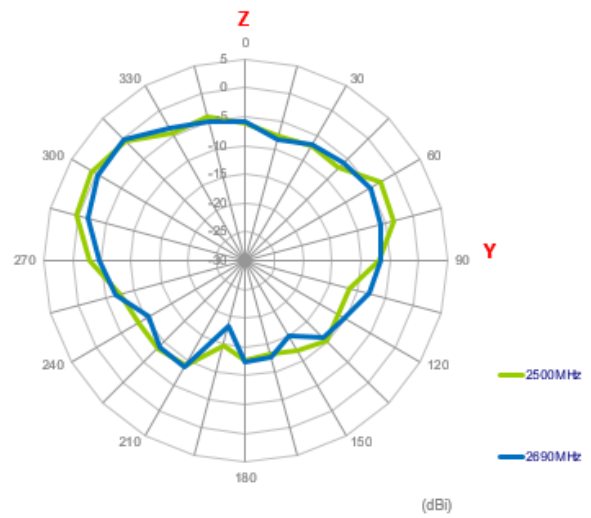
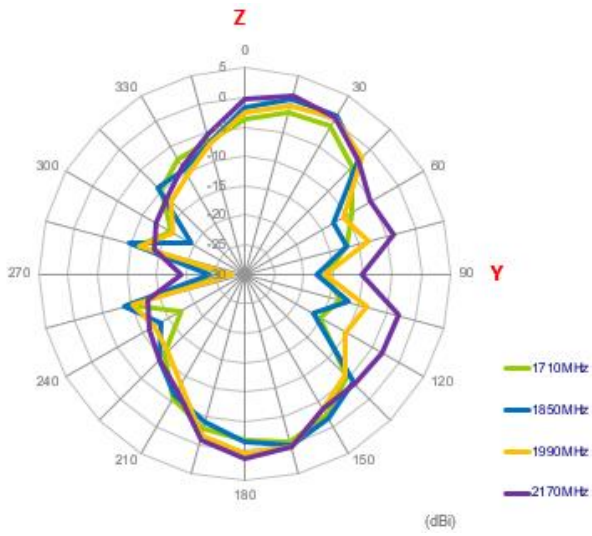
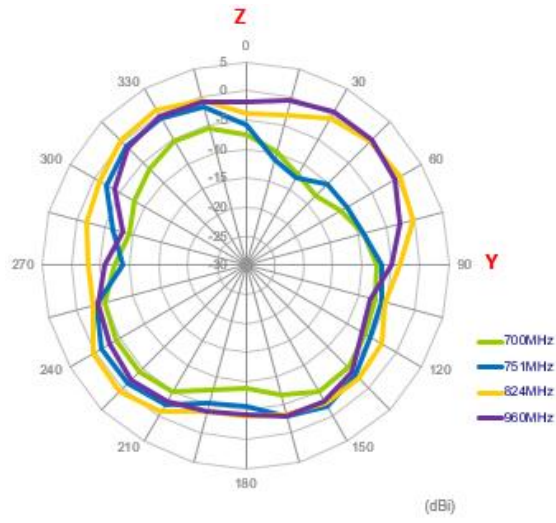

4.3. 3D Radiation Patterns

4.3.1. In free space

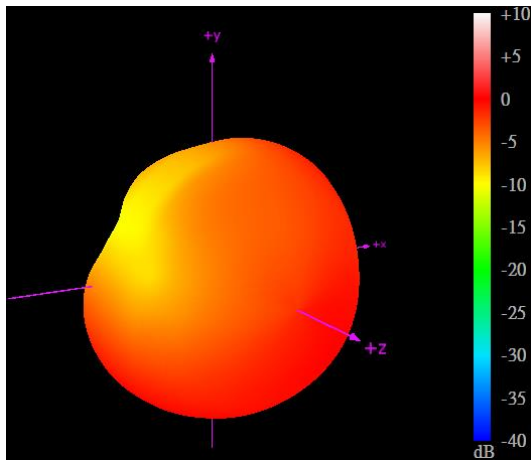

704 MHz

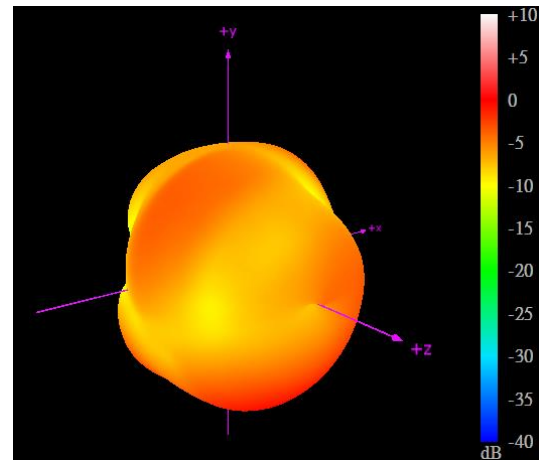

751 MHz

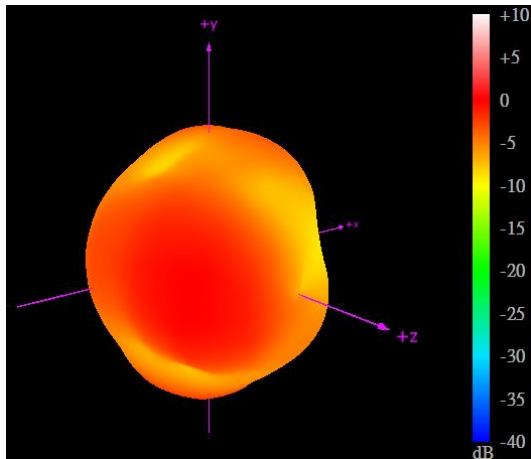

824 MHz

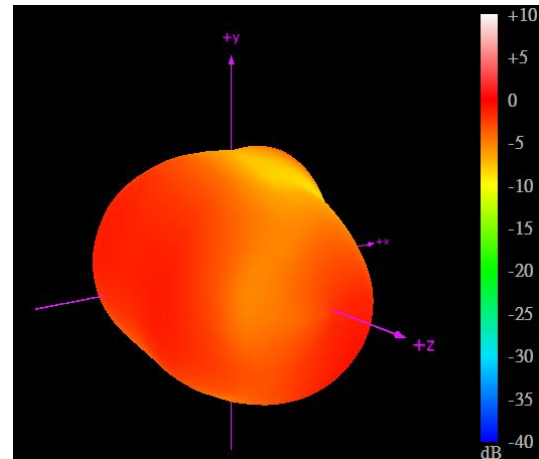

960 MHz

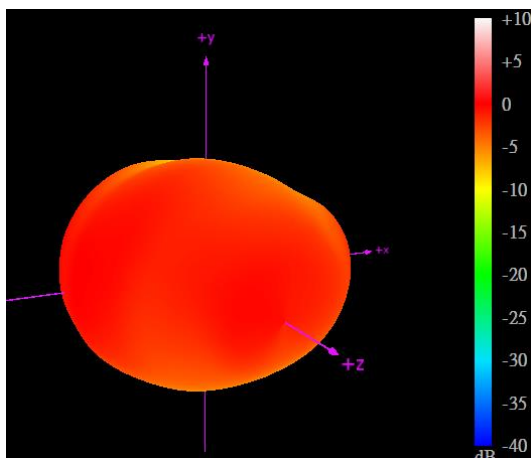

1710 MHz

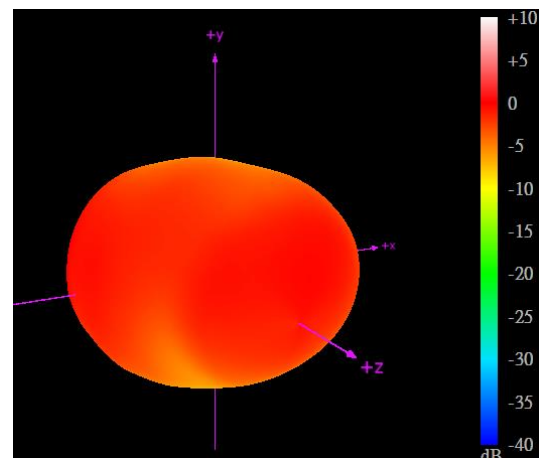

1850 MHz

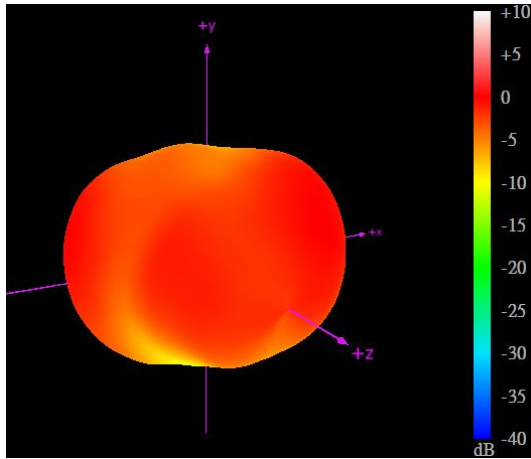

1990 MHz

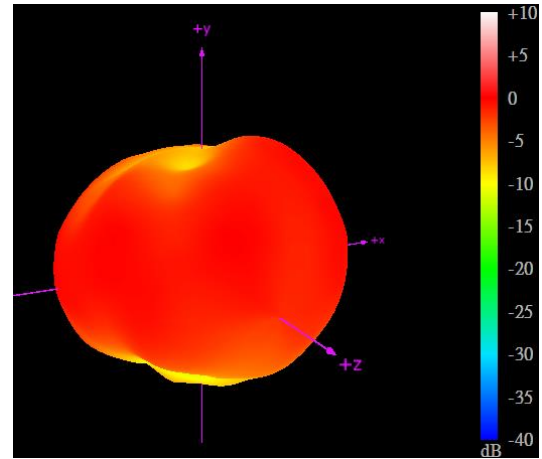

2170 MHz

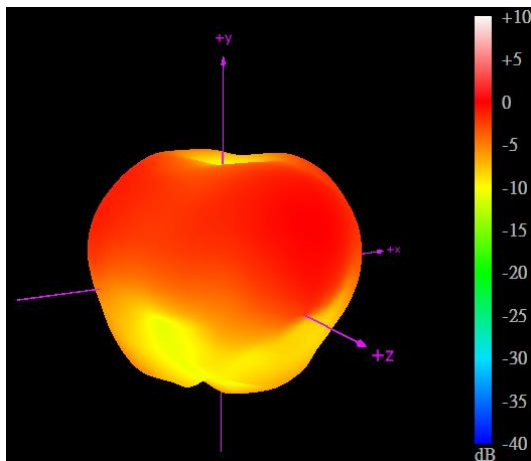

2500 MHz

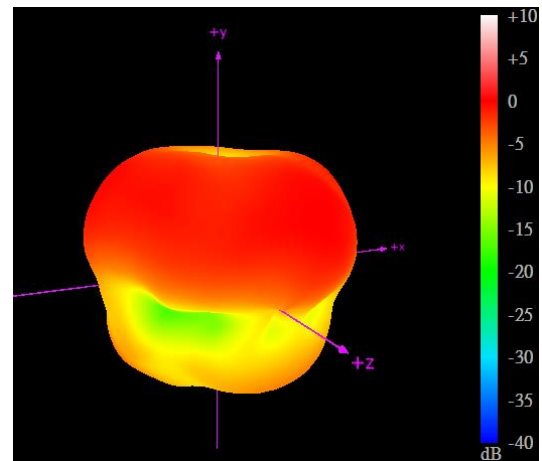

2690 MHz

4.3.2. On the 30x30cm Ground Center

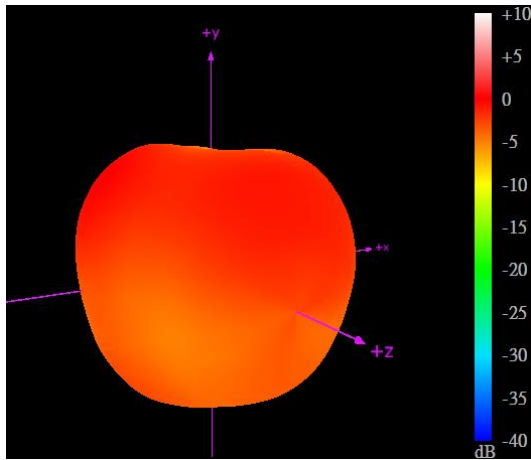

704 MHz

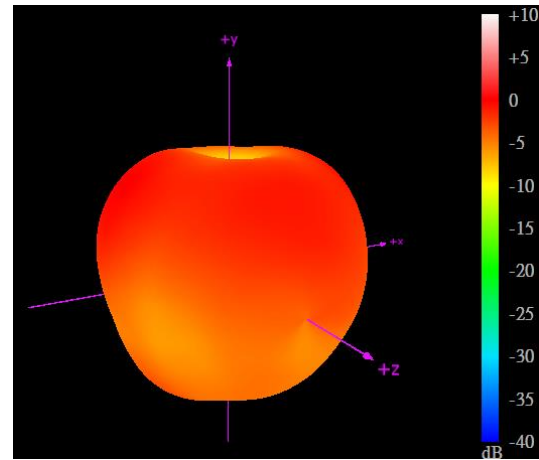

751 MHz

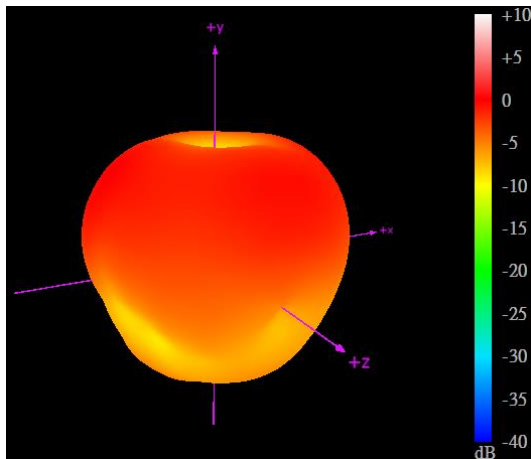

824 MHz

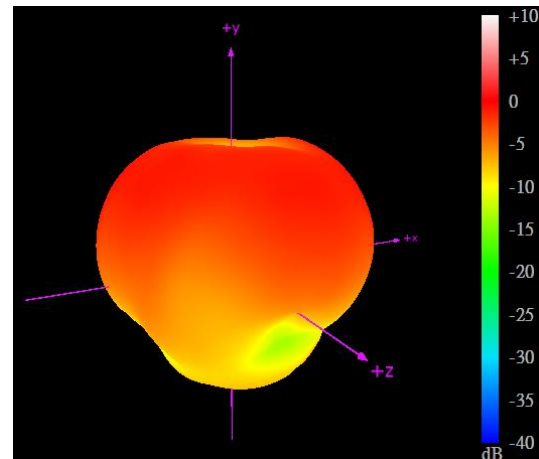

960 MHz

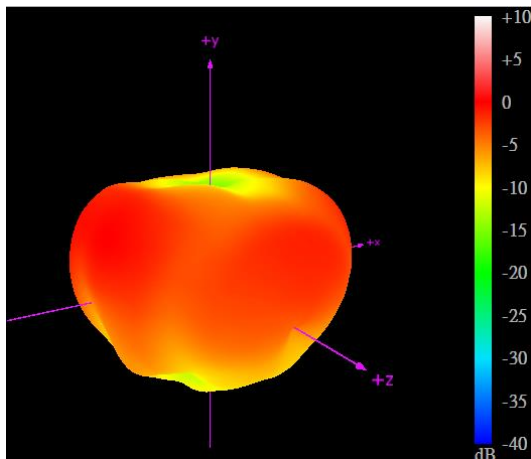

1710 MHz

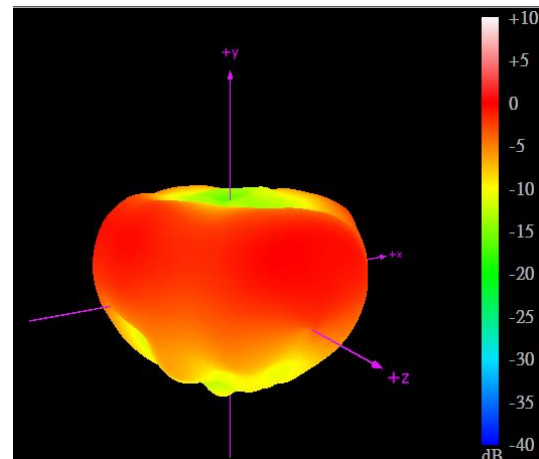

1850 MHz

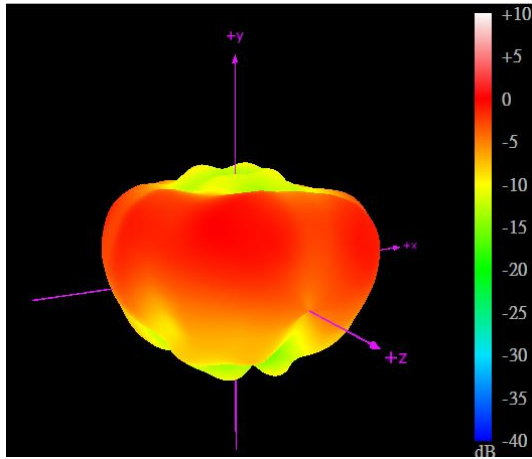

1990 MHz

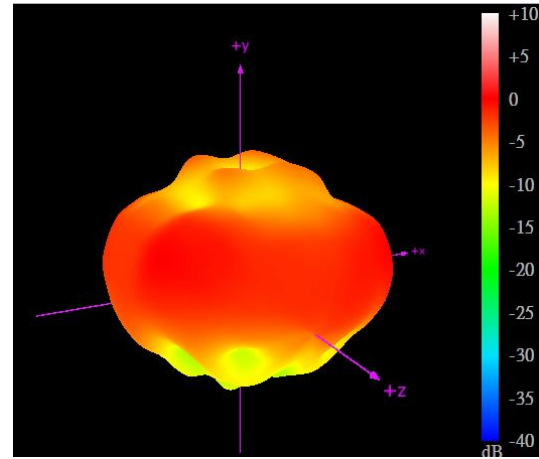

2170 MHz

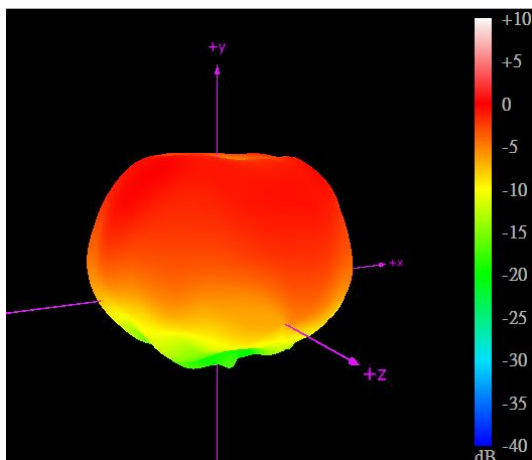

2500 MHz

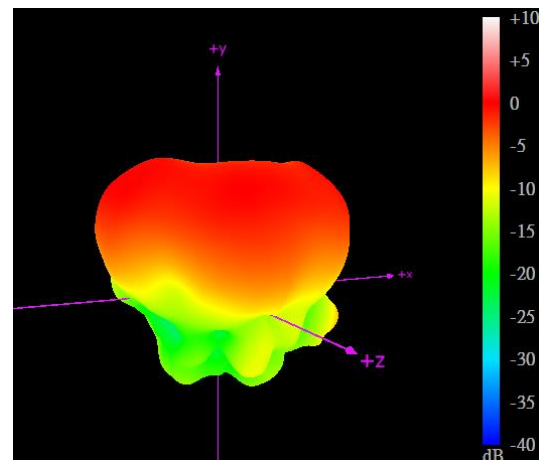

2690 MHz

5. Magnetic Pull Force (Kilogram – force (kgf))

Item No./Part No.	Magnetic force test Result	PASS/FAIL
Sample A(magnet type:N40)	2.8>1KGf	PASS
Sample B(magnet type:N40)	2.0>1KGf	PASS



6. Mechanical Drawing (Unit: mm)

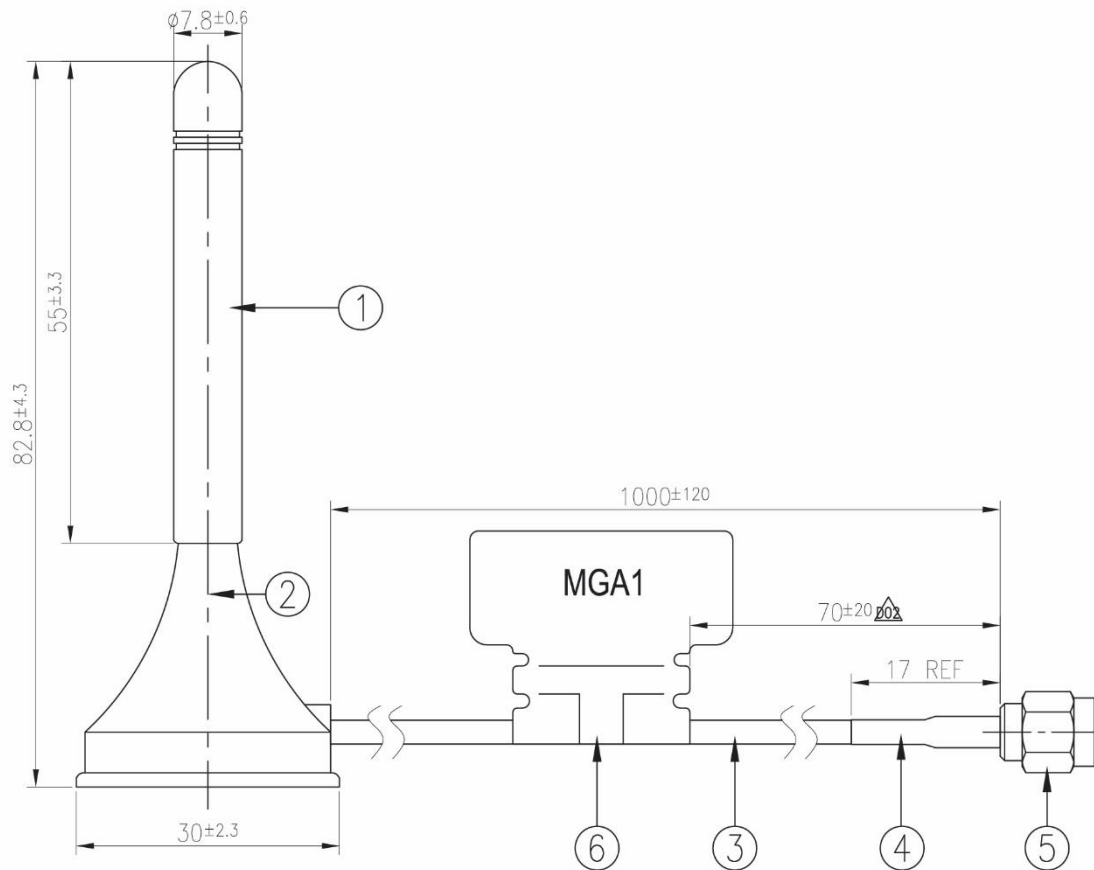

	Name	Material	Finish	QTY
1	MGA1 Antenna Housing	TPEE	Black	1
2	MGA1 Antenna Bottom	ABS	Black	1
3	RG174 Coaxial Cable	PVC	Black	1
4	Heat Shrink Tube	EVA	Black	1
5	SMA(M)ST	Brass	Au Plated	1
6	MGA1 Label	PEPA	White	1

7. Packaging

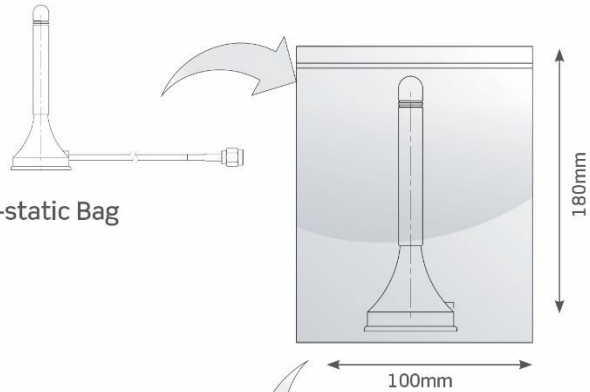

1pc MGA1.101111 in small in Anti-static Bag
 Dimensions - 100*180mm
 Weight - 32g

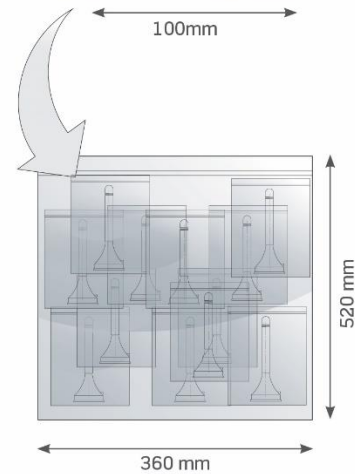

50 PE bags per large PE bags
 50 pcs MGA1.101111 per large PE bags
 Large PE bags Dimensions - 360 x 520mm
 Weight - 1.6kg

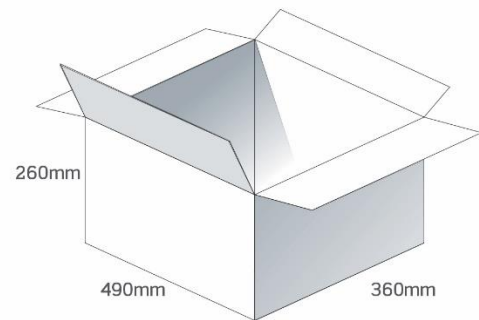

5 Large PE bags per carton
 250 pcs MGA1.101111 per carton
 Carton Dimensions - 490 x 360 x 260mm
 Weight - 8.3kg

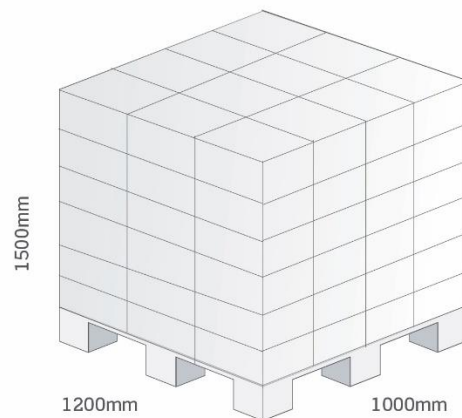

Pallet Dimensions 1200*1000*1500mm
 20 Cartons per Pallet
 4 Cartons per layer
 5 Layers

Taoglas makes no warranties based on the accuracy or completeness of the contents of this document and reserves the right to make changes to specifications and product descriptions at any time without notice. Taoglas reserves all rights to this document and the information contained herein.

Reproduction, use or disclosure to third parties without express permission is strictly prohibited.

Copyright © Taoglas Ltd.