



# TAOGLAS®



# Datasheet

## MCS6.A

### Description:

NB-IoT / CAT M1 Low Profile 4G SMD Dielectric Antenna

### Features:

GSM / CDMA / DCS / PCS / WCDMA / UMTS / HSDPA / GPRS / EDGE

NB-IoT / CAT M1 Bands

698~960MHz / 1710~2690MHz

High Efficiency Multi-Band SMD antenna

Low profile 42\*10\*3mm

RoHS & REACH Compliant

1. Introduction	3
2. Specifications	4
3. Antenna Characteristics	5
4. Radiation Patterns	8
5. Mechanical Drawing - Antenna	12
6. Antenna Integration Guide	14
7. Mechanical Drawing – Evaluation Board	21
8. Packaging	22
9. Application Note	23
Changelog	25

Taoglas makes no warranties based on the accuracy or completeness of the contents of this document and reserves the right to make changes to specifications and product descriptions at any time without notice. Taoglas reserves all rights to this document and the information contained herein.

Reproduction, use or disclosure to third parties without express permission is strictly prohibited.

Copyright © Taoglas Ltd.



# 1. Introduction



The MCS6.A is a low profile SMD NB-IoT / CAT M1 Bands / 4G/3G/2G embedded antenna designed for direct SMD mount on a device PCB. It provides high efficiency in a very small form factor of just 42\*10\*3mm.

NB-IoT / CAT M1 is a low power wide area (LPWA) technology specifically designed for IoT and M2M. NB-IoT / CAT M1 technology offers lower maintenance cost, with greater efficiency and reliability by reducing power consumption and providing deeper penetration compared to standard cellular technologies. It operates on secure mobile networks making it suited to automotive, smart meter, medical and smart city applications.

If tuning is required, the MCS6.A can be tuned for the device environment without the need for new tooling. Its rectangular shape and very small size make it very easy to integrate. It is supplied on tape and reel ensuring that it can be mounted via pick and place to reflow solder directly on the edge of the PCB board.

This antenna is recommended to be used with longer ground-plane lengths of 120mm or more to attain its highest rated efficiency. Note the Return Loss and Efficiency graphs on Page 16.

Contact your regional Taoglas Customer Support Team for quick and professional support from our senior engineering team on integration and matching of the antenna to your device.

## 2. Specifications

Electrical							
Frequency (MHz)	Band 2		Band 4		Band 12		
	Tx	Rx	Tx	Rx	Tx	Rx	
	1850-1910	1930-1990	1710-1755	2110-2155	699-716	729-746	
<b>Peak Gain (dBi)</b>							
On Evaluation Board	2.76	3.26	3.11	3.75	-1.05	-0.02	
<b>Average Gain (dB)</b>							
On Evaluation Board	-2.04	-1.67	-1.65	-1.85	-3.50	-2.25	
<b>Efficiency (%)</b>							
On Evaluation Board	62.46	67.47	68.33	65.67	44.58	59.60	
<b>Return Loss(dB)</b>							
On Evaluation Board	Typical	<-10	<-10	<-10	<-10	<-10	<-10
On Evaluation Board	Band Edge	<-6	<-6	<-7	<-7	<-5	<-5
Impedance		50Ω					
Polarization		Linear					
Maximum Input Power		5W					
Mechanical							
Antenna Dimensions		42mm x 10mm x 3mm					
Material		FR4					
Weight		2.50g					
Soldering Type		SMT through Reflow					
Environmental							
Operation Temperature		-40°C ~ +85°C					
Storage Temperature		-40°C ~ +85°C					
Moisture Sensitivity Level (MSL)		3 (168 Hours)					

\*All measurements were done on 123\*45mm Evaluation board with 100mm length ground plane.

5G/4G Bands			
Band Number	5G NR / FR1 / LTE / LTE-Advanced / WCDMA / HSPA / HSPA+ / TD-SCDMA		
	Uplink	Downlink	Covered
1	UL: 1920 to 1980	DL: 2110 to 2170	✓
2	UL: 1850 to 1910	DL: 1930 to 1990	✓
3	UL: 1710 to 1785	DL: 1805 to 1880	✓
4	UL: 1710 to 1755	DL: 2110 to 2155	✓
5	UL: 824 to 849	DL: 869 to 894	✓
7	UL: 2500 to 2570	DL: 2620 to 2690	✓
8	UL: 880 to 915	DL: 925 to 960	✓
9	UL: 1749.9 to 1784.9	DL: 1844.9 to 1879.9	✓
11	UL: 1427.9 to 1447.9	DL: 1475.9 to 1495.9	✓
12	UL: 699 to 716	DL: 729 to 746	✓
13	UL: 777 to 787	DL: 746 to 756	✓
14	UL: 788 to 798	DL: 758 to 768	✓
17	UL: 704 to 716	DL: 734 to 746 (LTE only)	✓
18	UL: 815 to 830	DL: 860 to 875 (LTE only)	✓
19	UL: 830 to 845	DL: 875 to 890	✓
20	UL: 832 to 862	DL: 791 to 821	✓
21	UL: 1447.9 to 1462.9	DL: 1495.9 to 1510.9	✓
22	UL: 3410 to 3490	DL: 3510 to 3590	✓
23	UL: 2000 to 2020	DL: 2180 to 2200 (LTE only)	✓
24	UL: 1625.5 to 1660.5	DL: 1525 to 1559 (LTE only)	✓
25	UL: 1850 to 1915	DL: 1930 to 1995	✓
26	UL: 814 to 849	DL: 859 to 894	✓
27	UL: 807 to 824	DL: 852 to 869 (LTE only)	✓
28	UL: 703 to 748	DL: 758 to 803 (LTE only)	✓
29	UL: -	DL: 717 to 728 (LTE only)	✓
30	UL: 2305 to 2315	DL: 2350 to 2360 (LTE only)	✗
31	UL: 452.5 to 457.5	DL: 462.5 to 467.5 (LTE only)	✗
32	UL: -	DL: 1452 - 1496	✗
35		1850 to 1910	✓
38		2570 to 2620	✓
39		1880 to 1920	✓
40		2300 to 2400	✗
41		2496 to 2690	✓
42		3400 to 3600	✗
43		3600 to 3800	✗
48		3550 to 3700	✗
66	UL: 1710-1780	DL: 2110-2200	✓
71		617 to 698	✗
74/75/76		1427 to 1518	✗
78		3300 to 3800	✗
79		4400 to 5000	✗

\*Covered Bands Represent Efficiency over 20%

### 3. Antenna Characteristics

#### 3.1 Return Loss

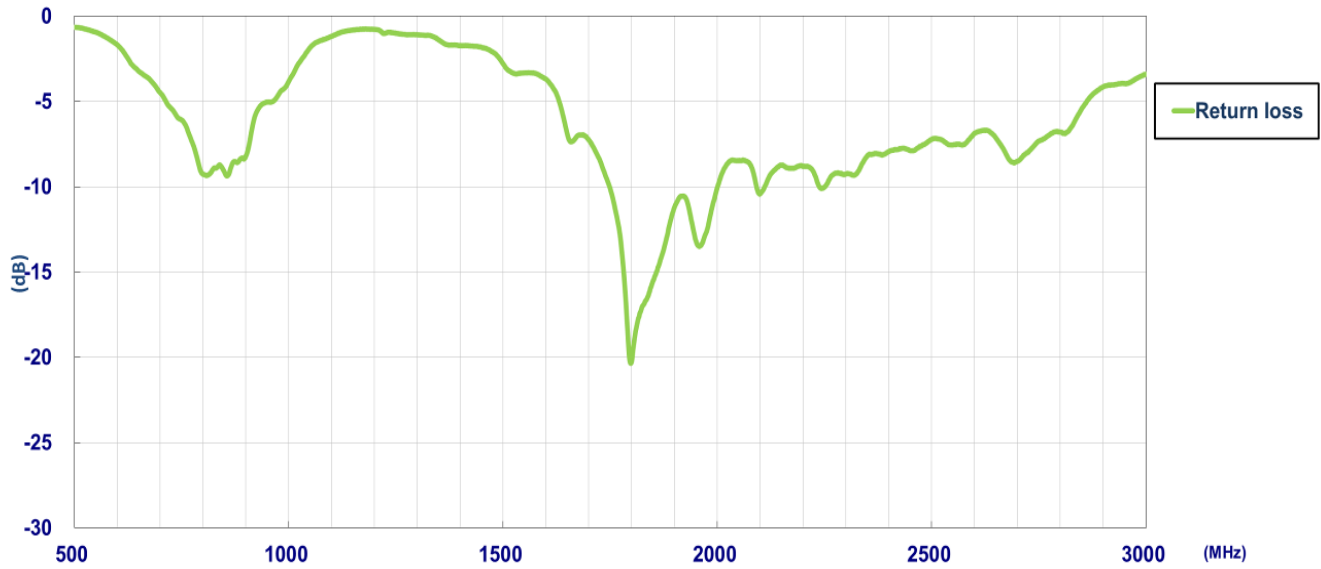

#### 3.2 Efficiency

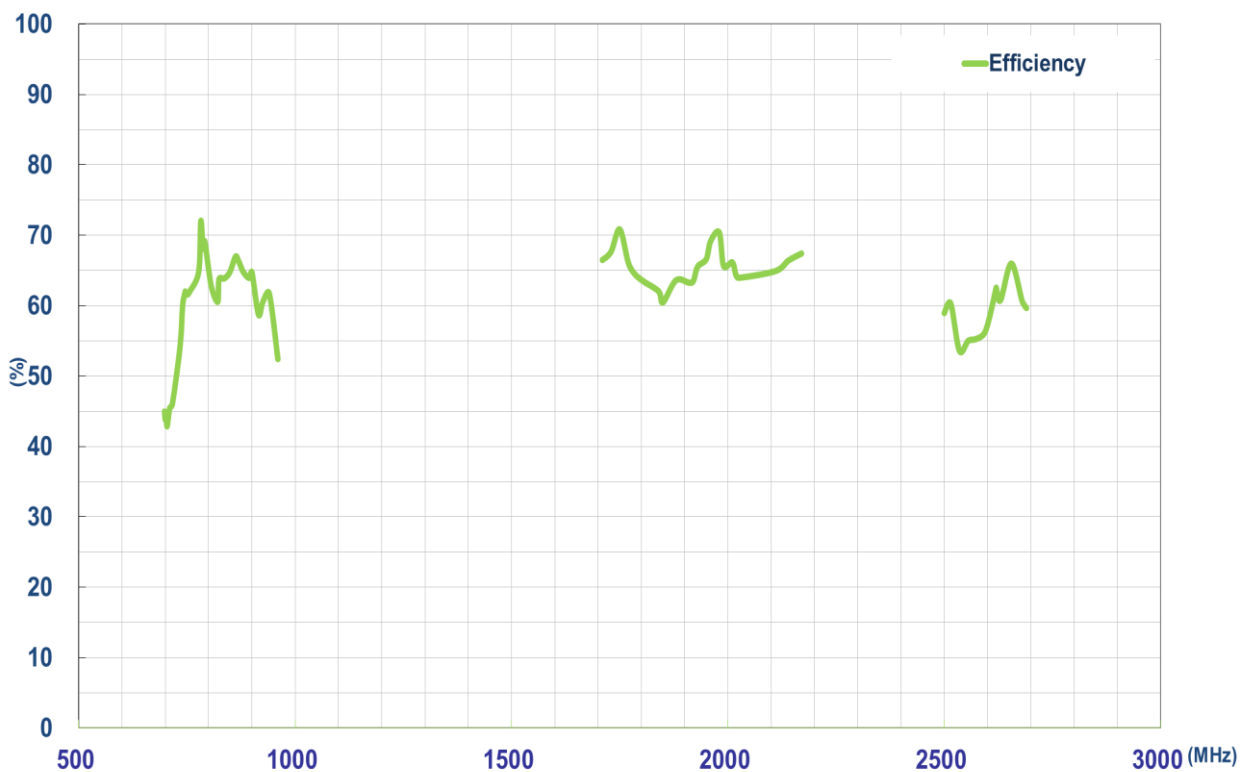

### 3.3 Average Gain

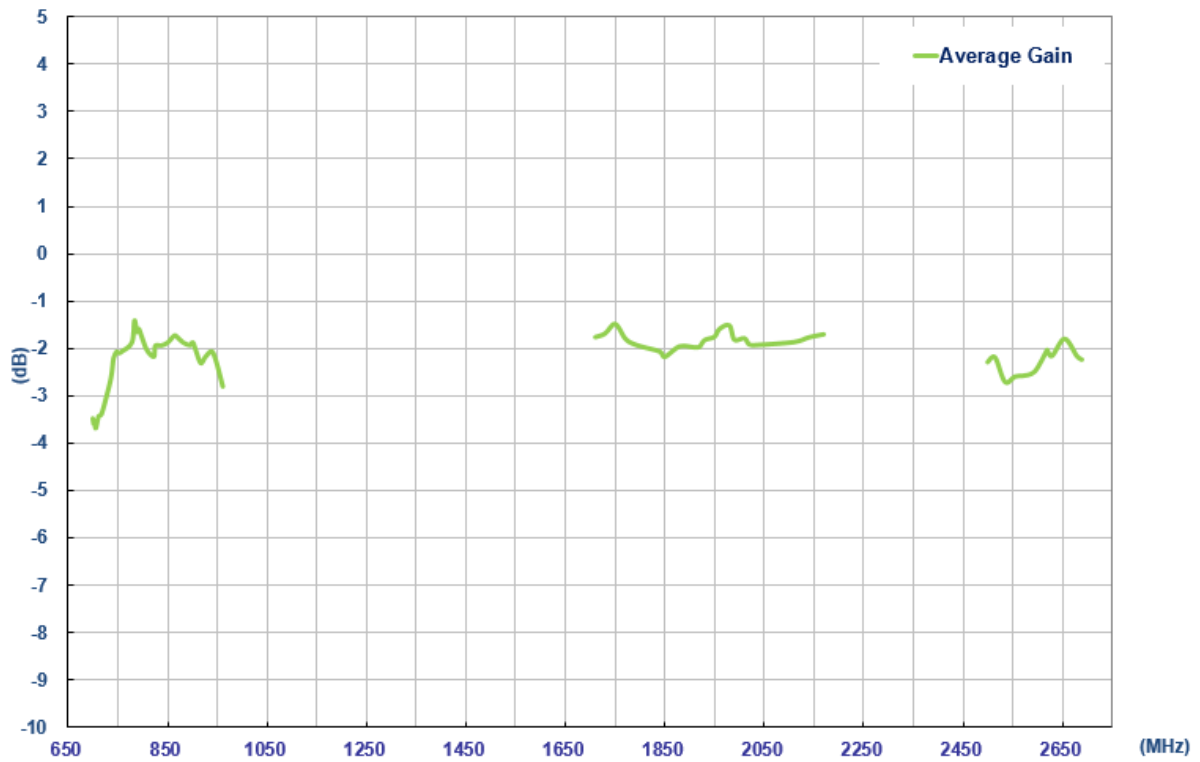

### 3.4 Peak Gain

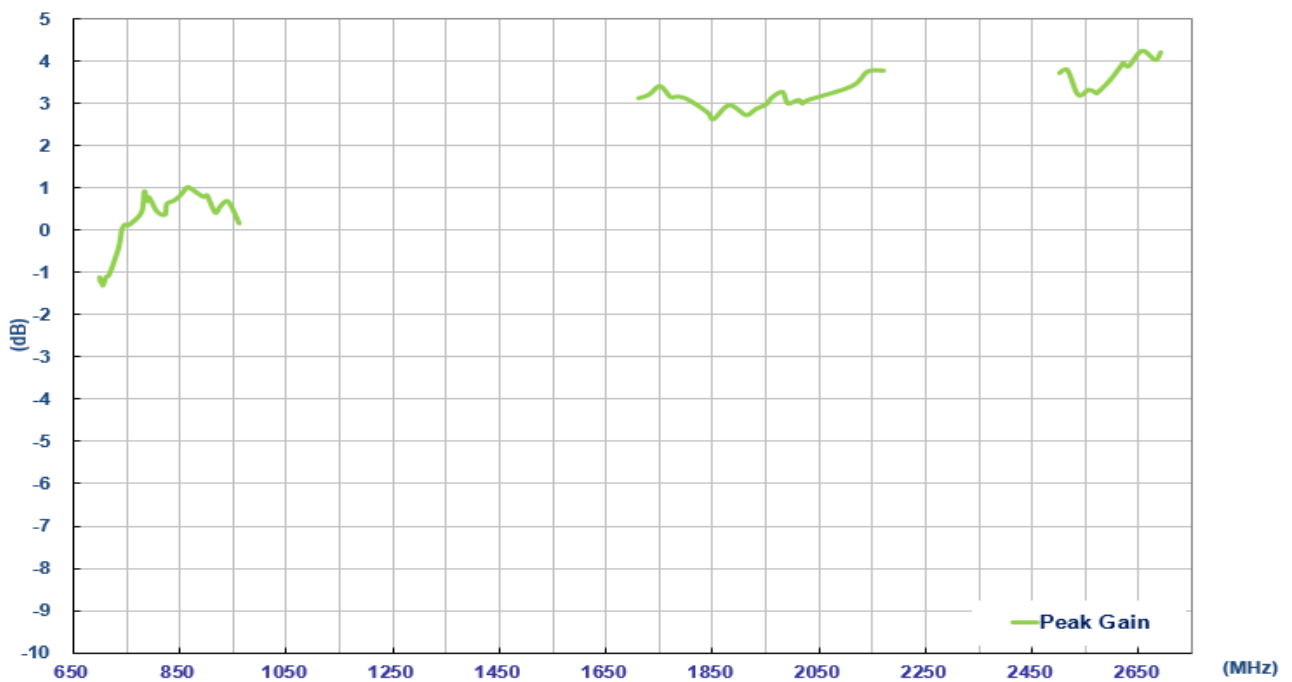

## 4. Radiation Patterns

### 4.1 Test Setup

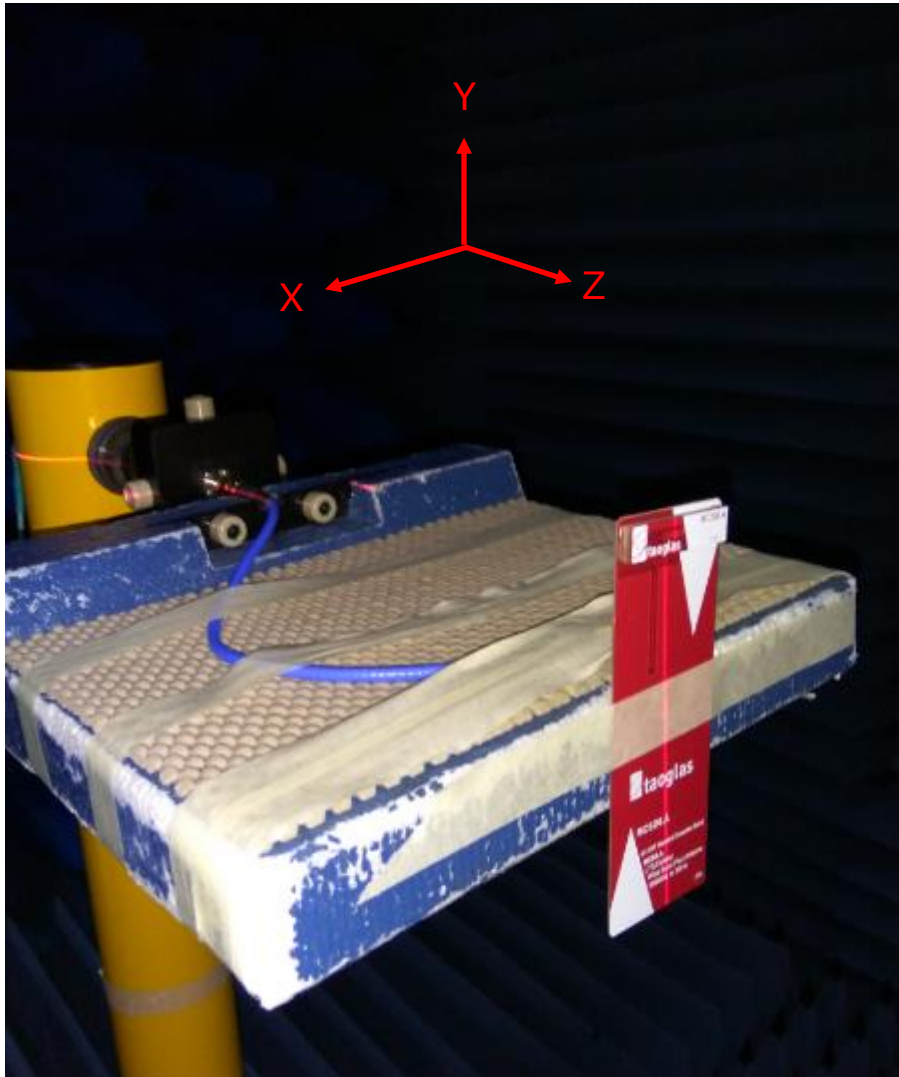

Free space



## 4.2 2D & 3D Radiation Patterns

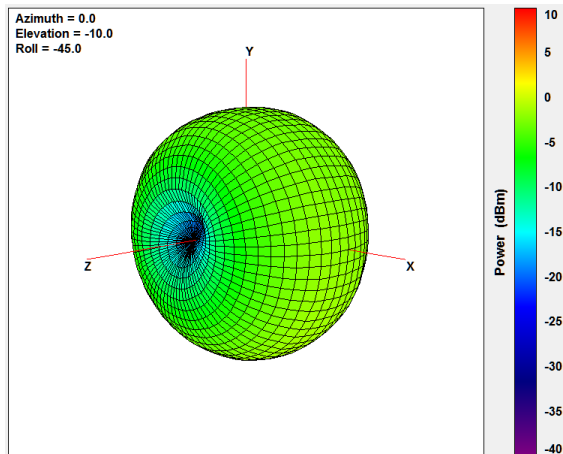

698MHz

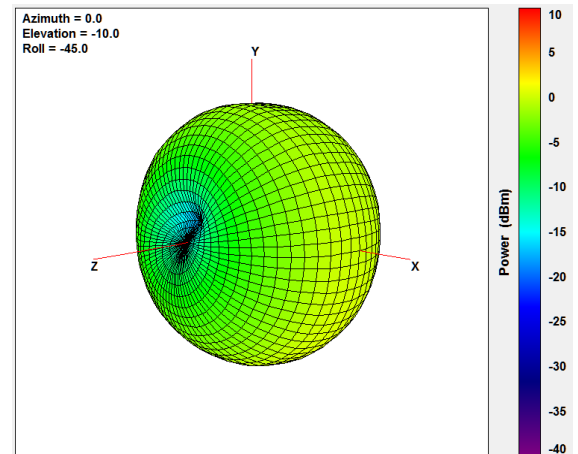

824MHz

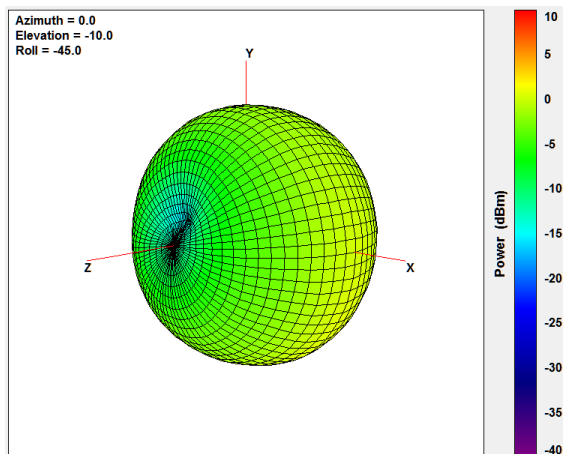

894MHz

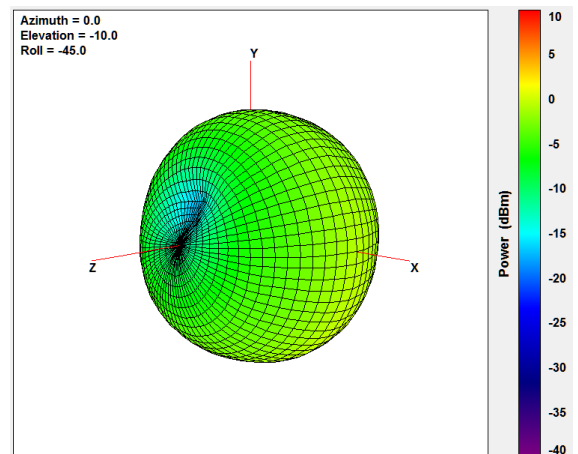

960MHz

XY Plane

XZ Plane

YZ Plane

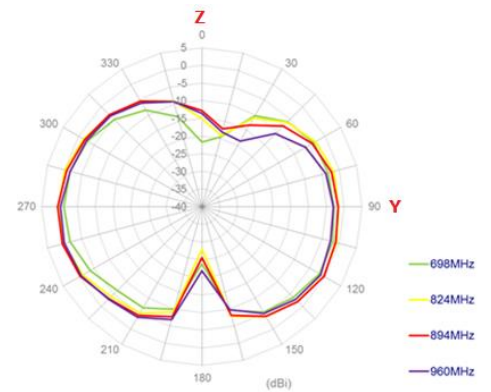
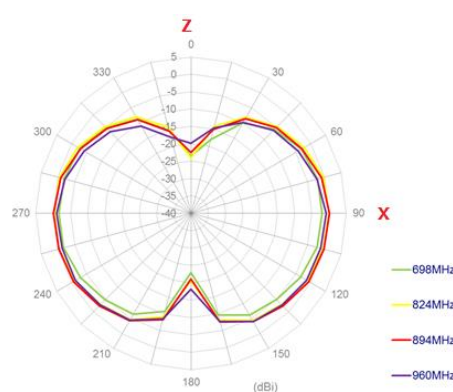
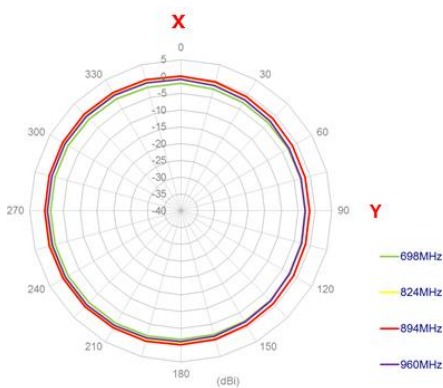

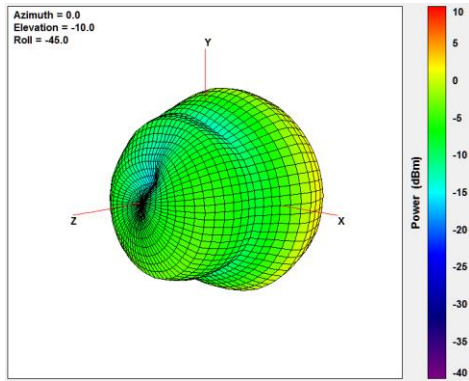

1710MHz

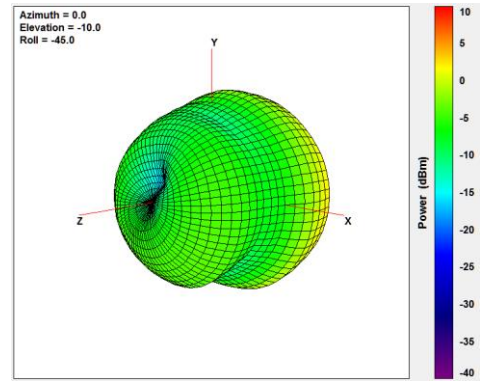

1805MHz

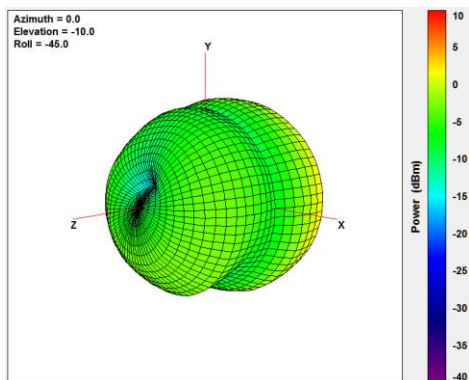

1910MHz

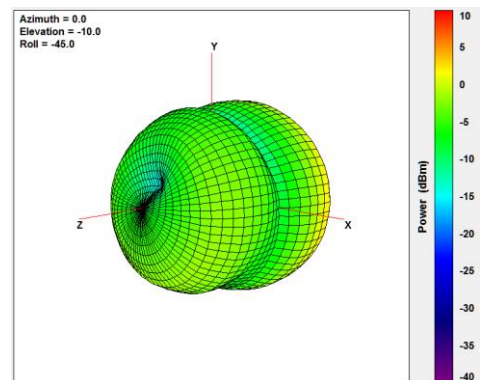

1990MHz

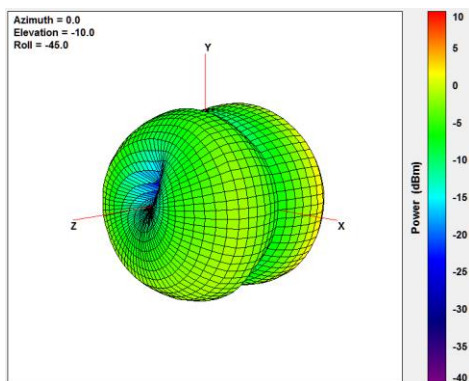

2170MHz

XY Plane | XZ Plane | YZ Plane

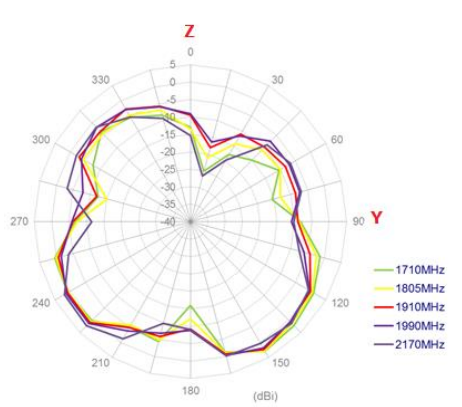
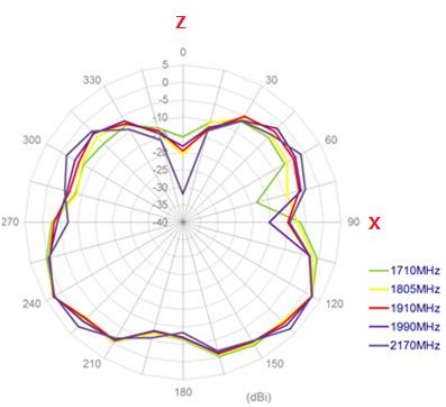
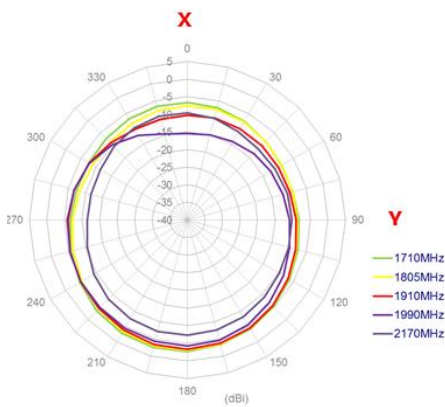

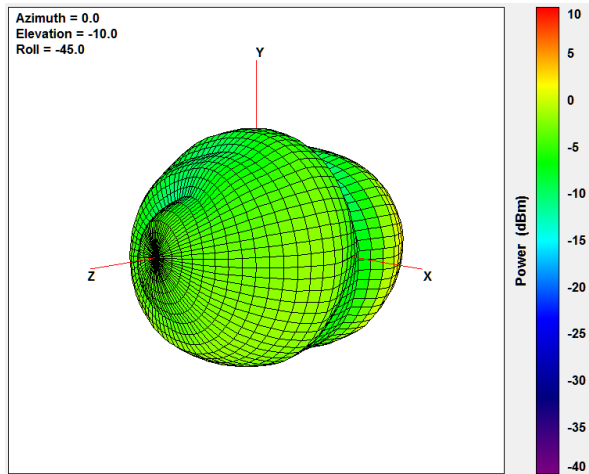

2500MHz

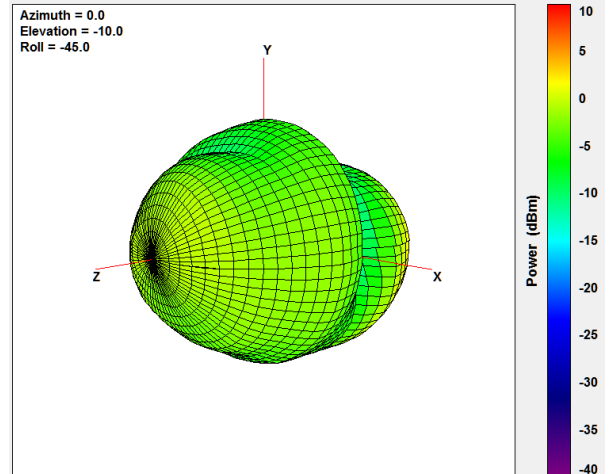

2620MHz

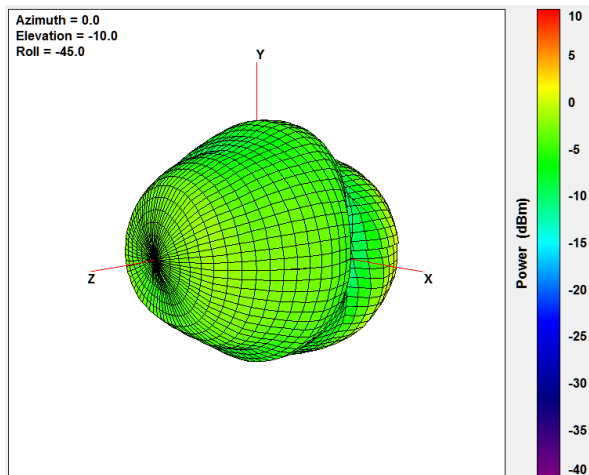

2690MHz

XY Plane      XZ Plane      YZ Plane

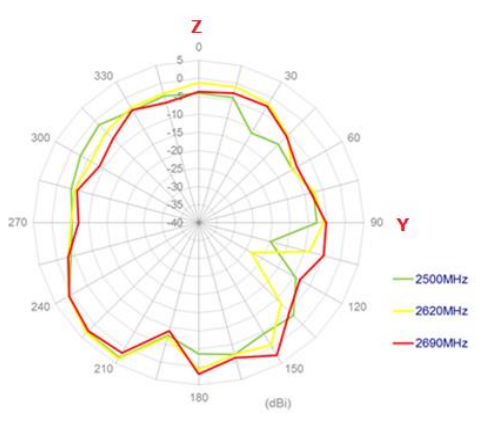
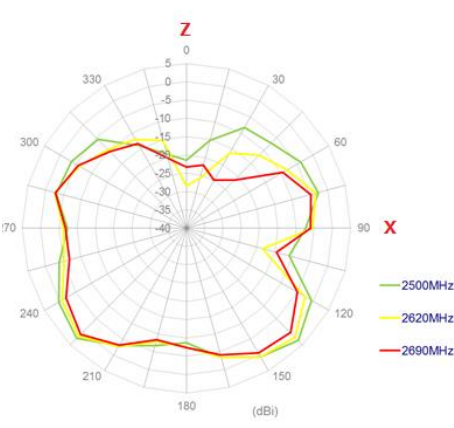
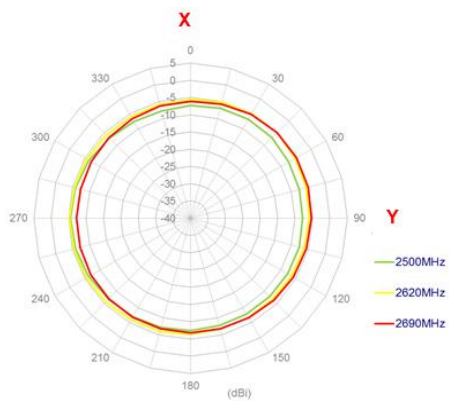

## 5. Mechanical Drawing - Antenna

### 5.1 Mechanical Drawing

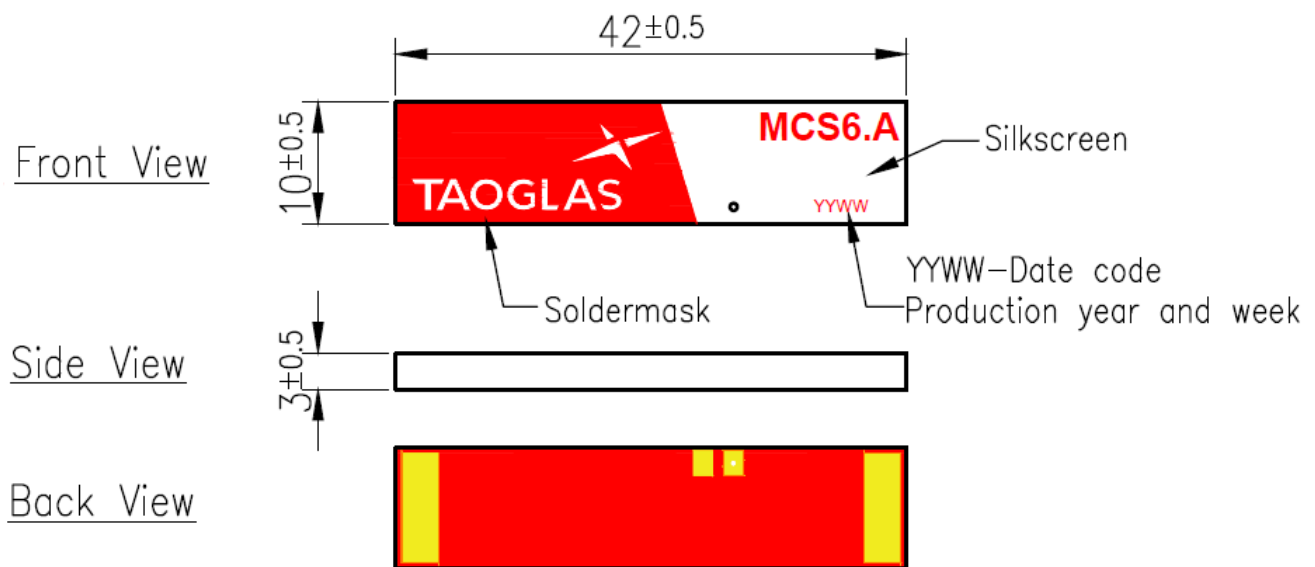

## 5.2 Footprint

### FootPrint

#### Top Copper

Pads 1 and 2 are the same size, Pads 3 and 4 are the same size, Pad 4 should be connected to a 50 ohm transmission line.

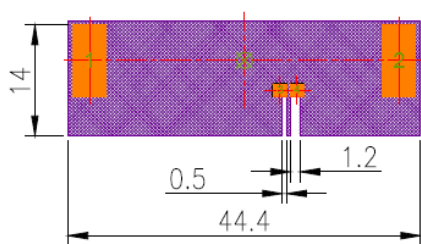

B

Pin/Pad Number	Value
1	NC (No connect / Open)
2	NC (No connect / Open)
3	Ground
4	Feed Line

#### Top Solder Paste

Pads 1 and 2 are the same size, Pads 3 and 4 are the same size.

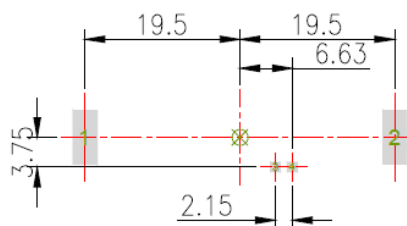

#### Top Solder Mask

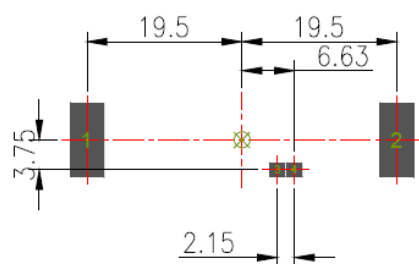

#### Composite Diagram

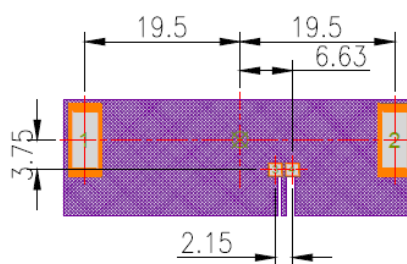

#### NOTE:

1. Au Plated area
2. Solder Mask area
3. Copper area
4. Paste area
5. Keepout Region area
6. Silkscreen
7. Soldermask



8. Ground keepout should extend through any inner PCB layers and any sides around the antenna till the board edge to minimize coupling from RF feed to ground, except the side facing system ground.
9. Any vias in pads should be either filled or tented to prevent solder from wicking away from the pad during reflow.
10. The dimension tolerances should follow standard PCB manufacturing guidelines.

## 6. Antenna Integration Guide

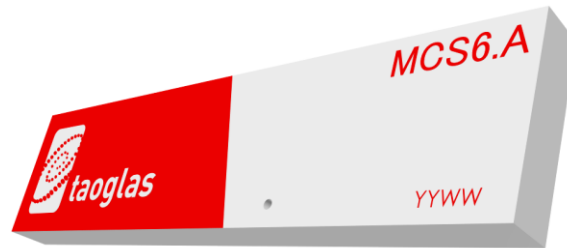

## 6.1 Schematic Symbol and Pin Definition

The circuit symbol for the antenna is shown below. The antenna has 4 pins with only two pins (Pin 1 and Pin 2) as functional. Pins 3 and 4 are for mechanical strength.

Pin	Description
1	RF Feed
2	Ground
3,4	Mechanical, Not Connected

MCS6.A  
ANT1

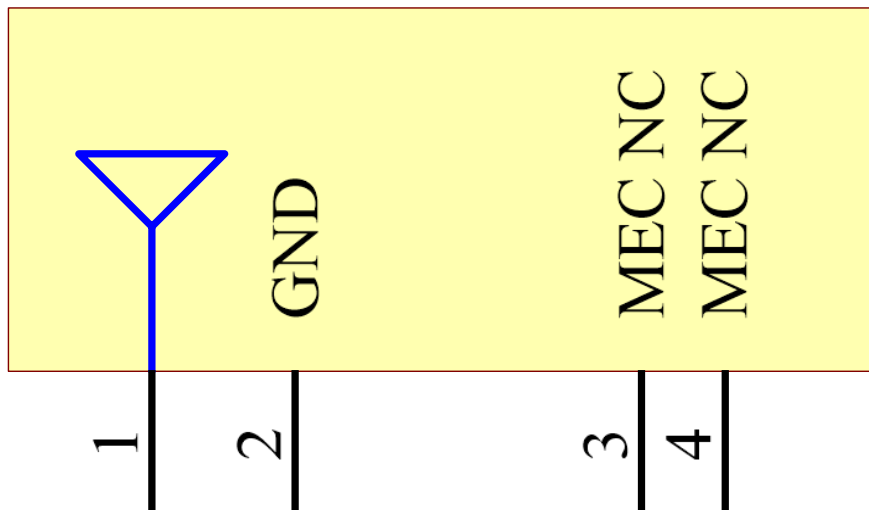

## 6.2 Antenna Integration

For any given PCB size, the antenna should ideally be placed on the PCB's longest side, to take advantage of the ground plane. Optimized matching components can be placed as shown.



Top Side w/ Solder Mask

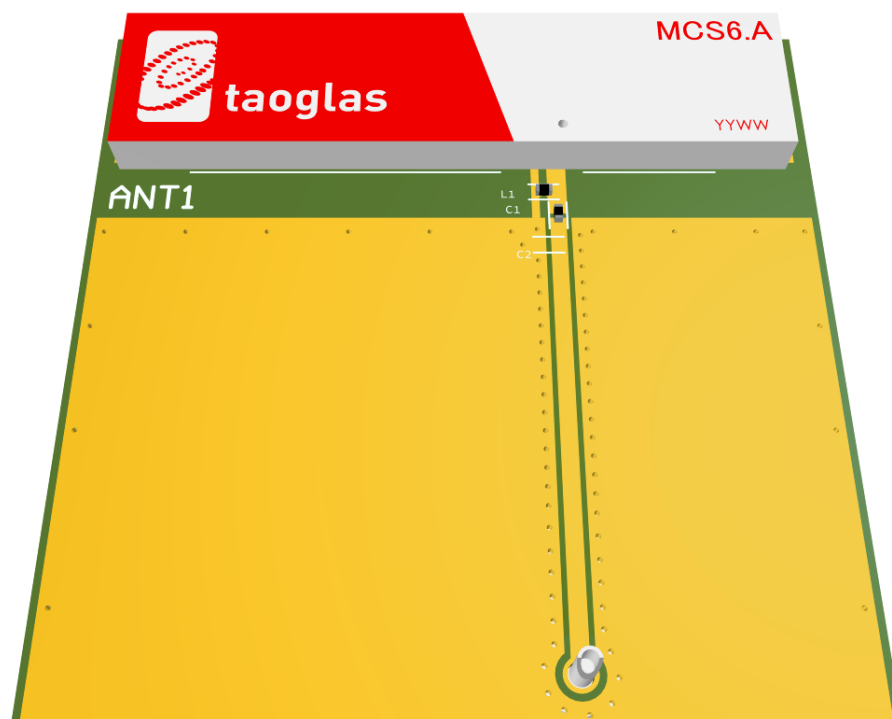

Top Side w/o Solder Mask



## 6.3 PCB Layout

The footprint and clearance on the PCB must meet the layout drawing in (Footprint Drawing). Note the placement of the optimized components. L1 is placed as close as possible to the RF feed (pad 1) but still within the transmission line. C1 is then placed tightly in series after that. C2 is an optional component but the footprint is recommended in case it is needed.

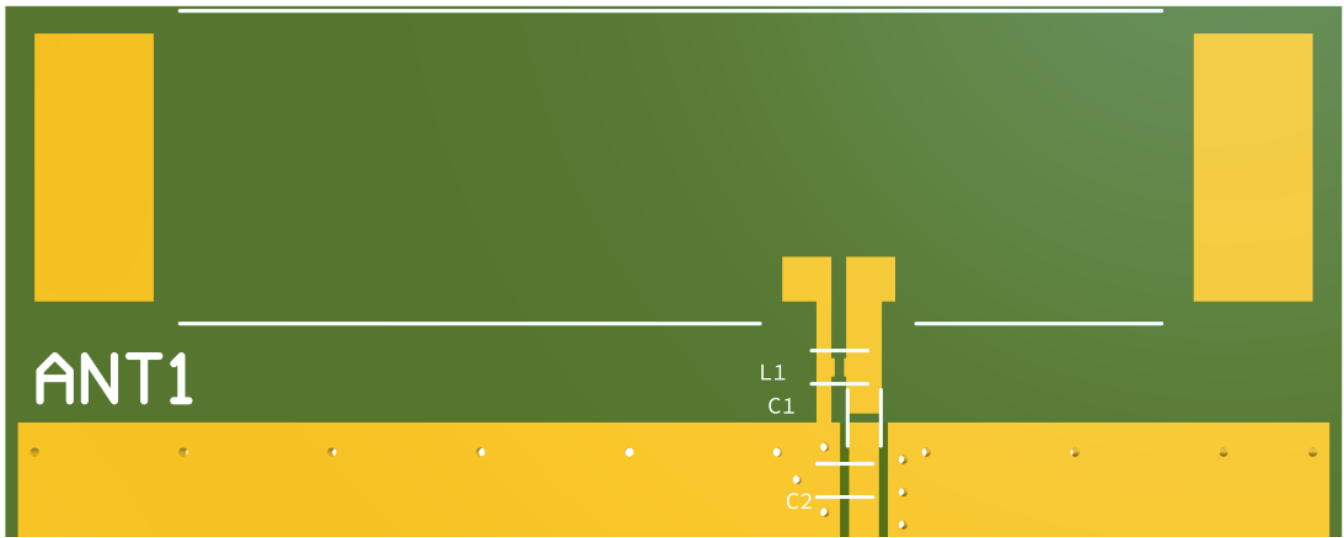

Topside



Bottom Side

## 6.4 PCB Clearance

Below shows the antenna footprint and clearance through ALL layers on the PCB. Only the antenna pads and connections to feed and GND are present within this clearance area (marked RED). The clearance area extends to 2.8mm in length & 10.6mm in width from the centre of the PCB. This clearance area includes the bottom side and ALL internal layers on the PCB.

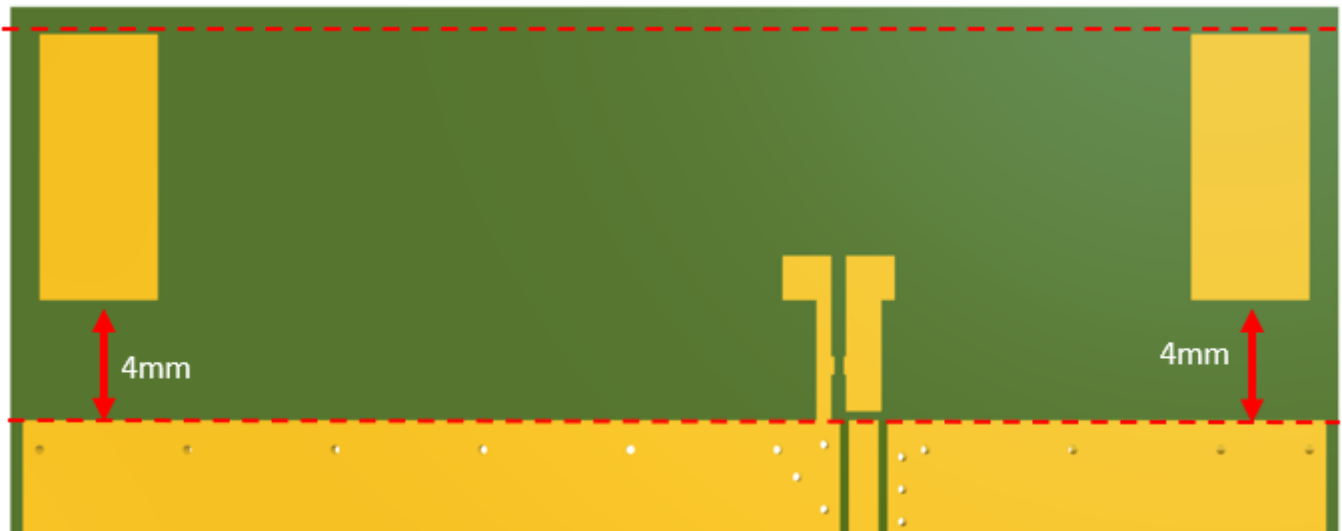

Topside



Bottom Side

6.5 Evaluation Board

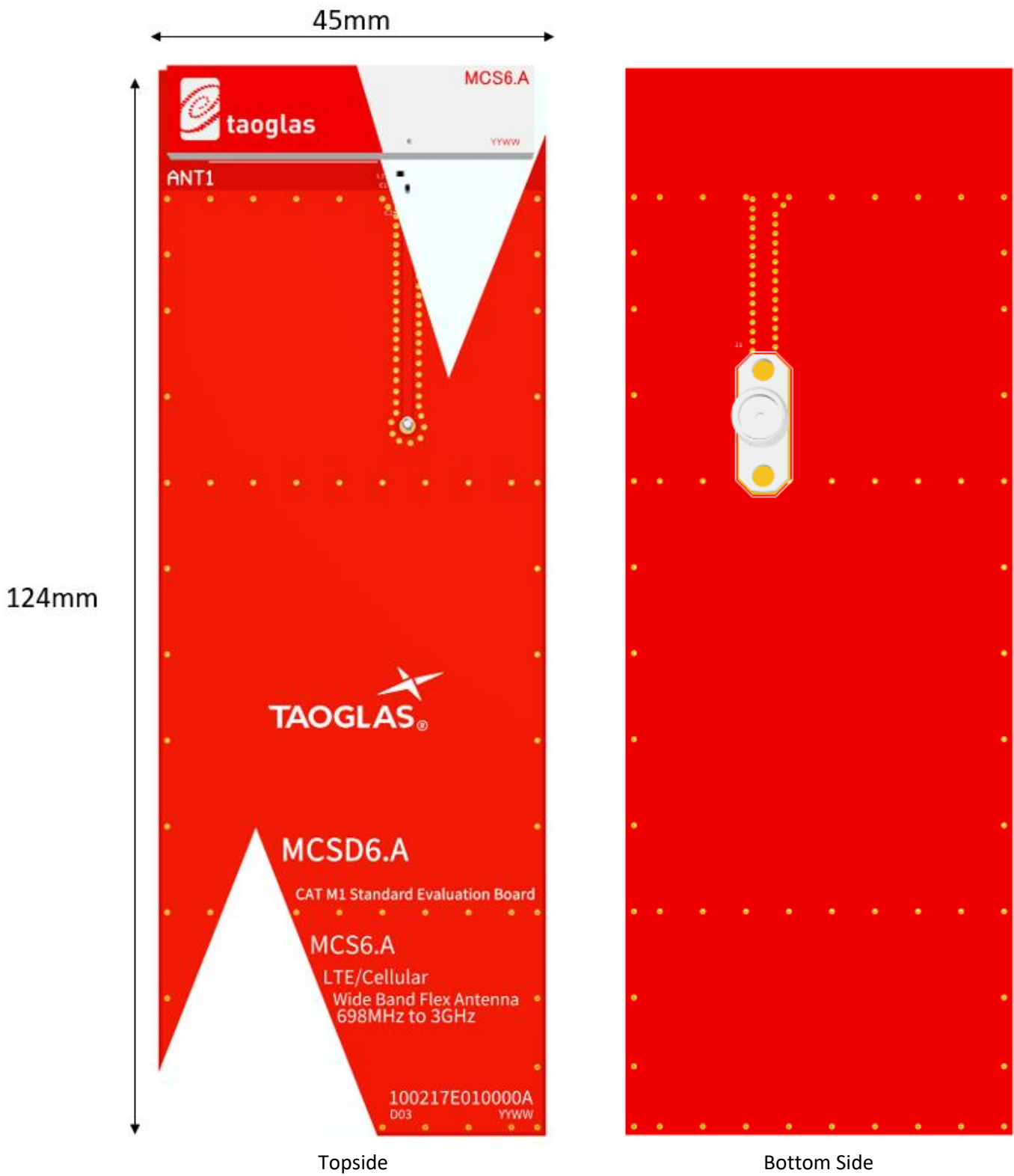

Topside

Bottom Side

## 6.6 Evaluation Board Matching Circuit

A matching component (L1) in parallel with the MCS6.A is required for the antenna to have optimal performance on the evaluation board, located outside of the ground plane in the space specified in the above images. Additional matching components may be necessary for your device, so we recommend incorporating extra component footprints, forming a “pi” network, between the cellular module and the edge of the ground

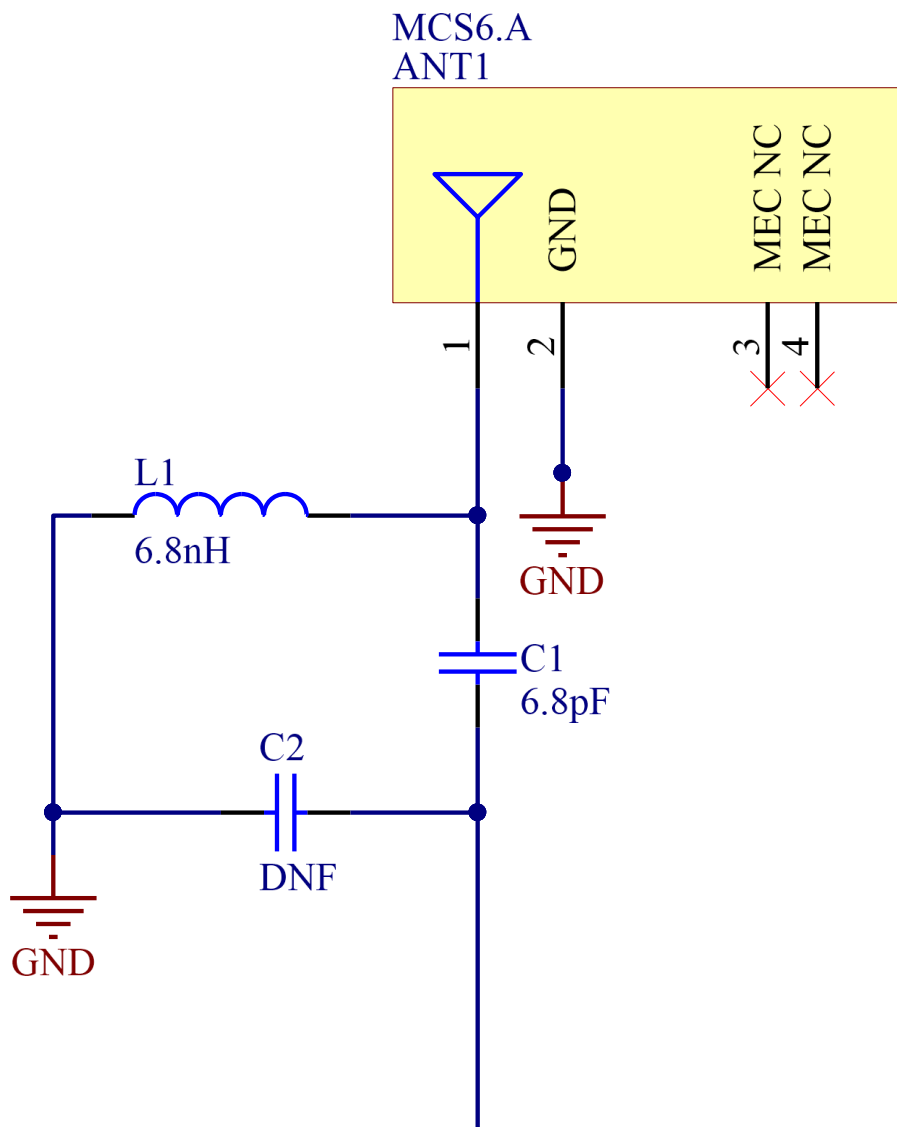

Designator	Type	Value	Manufacturer	Manufacturer Part Number
L1	Inductor	6.8nH	TDK	MLK1005S6N8DT000
C1	Capacitor	6.8pF	Murata	GRM1555C1H6R8CA01D
C2	Capacitor	Not Fitted	-	-

# 7. Mechanical Drawing – Evaluation Board

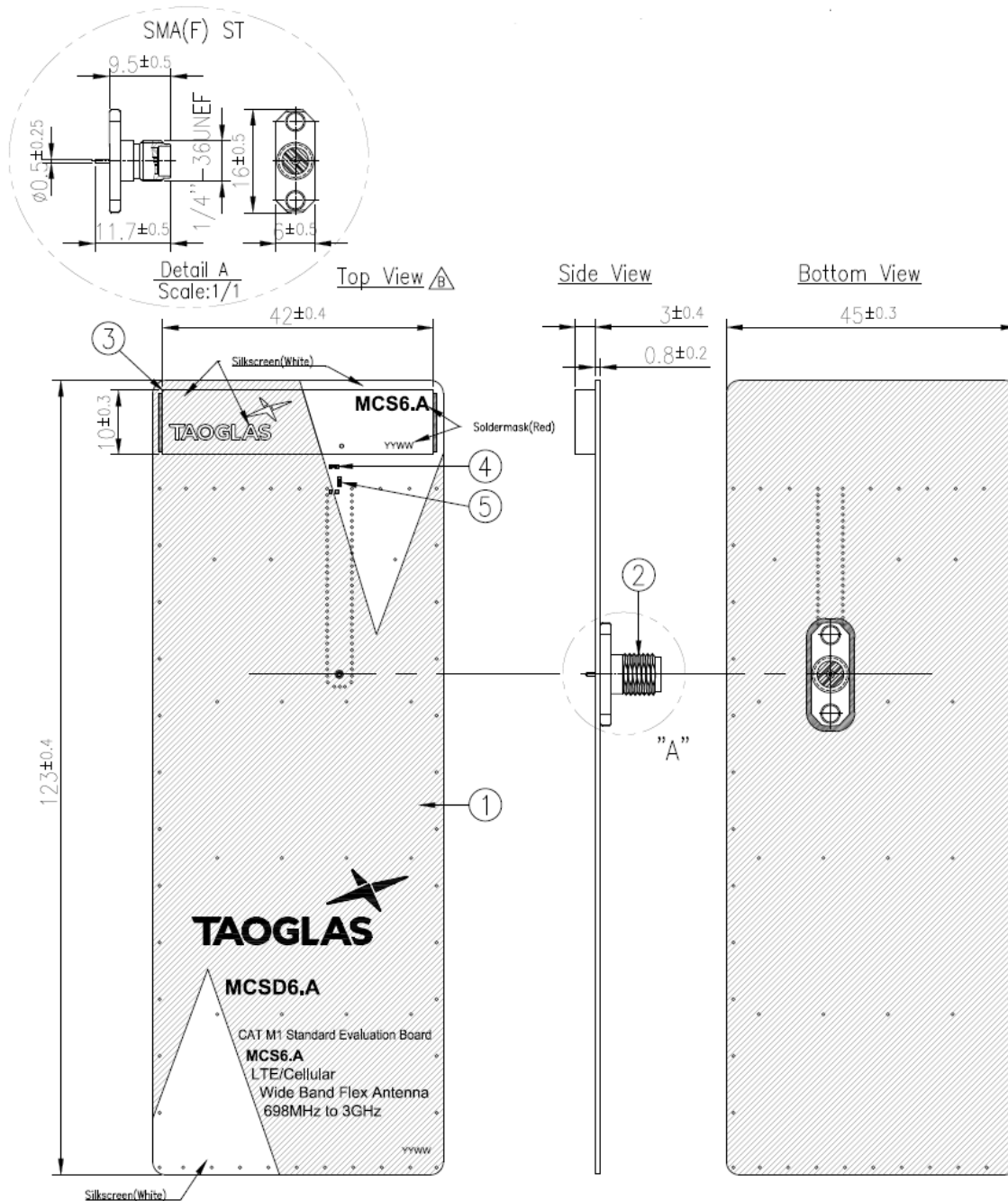

Note:

1. Week Batch Code  
Example: 2013 Week 10=1310
2. Soldered area
3. Soldermask area(Red)
4. Silkscreen : White

	Name	P/N	Material	Finish	QTY
1	MCS6.A EVB PCB	100217E010000A	Composite 0.8t	Red	1
2	SMA(F) ST PCB	200413B000002A	Brass	Au Plated	1
3	MCS6.A PCB Antenna	100217E020000A	Composite 3t	Red	1
4	6.8nH Inductor (0402)	001513A000055A	Ceramic	N/A	1
5	6.8pF Capacitor (0402)	001512I000055A	Ceramic	N/A	1

## 8. Packaging

1000 pcs MCS6.A reel  
 Dimensions - 330\*330\*60mm  
 Weight - 2kg

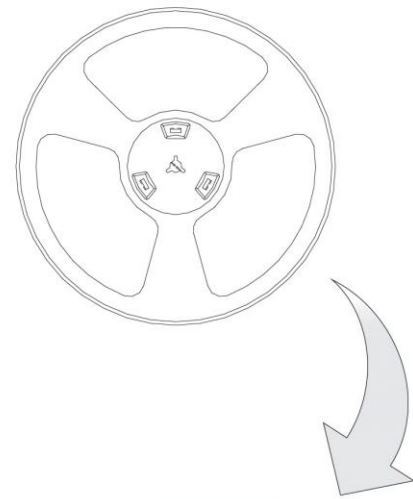

1000 pcs MCS6.A / 1 Reel in small box  
 Dimensions - 335\*340\*90mm  
 Weight - 2.1Kg

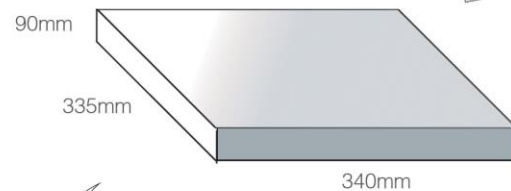

4 reels, 4000 pcs in one carton  
 Carton Dimensions - 370\*360\*370mm  
 Weight - 9.2Kg

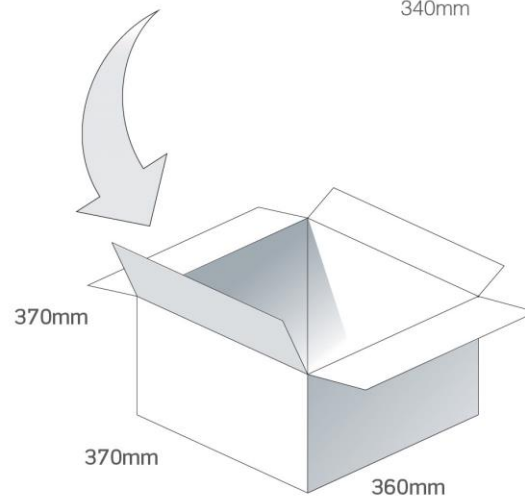

Pallet Dimensions 1200\*1000\*1310mm  
 18 Cartons per Pallet  
 6 Cartons per layer  
 3 Layers

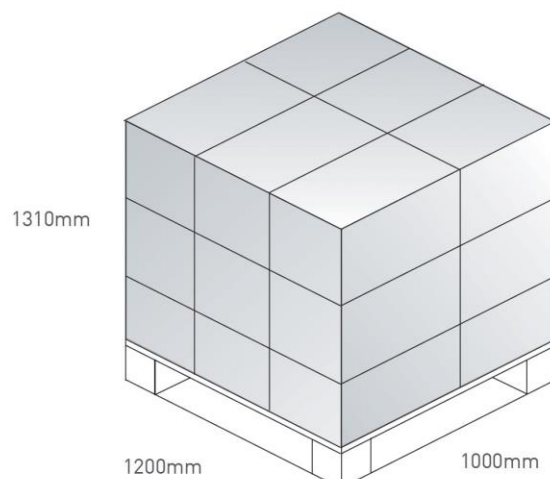

## 9. Application Note

### 9.1 Return Loss

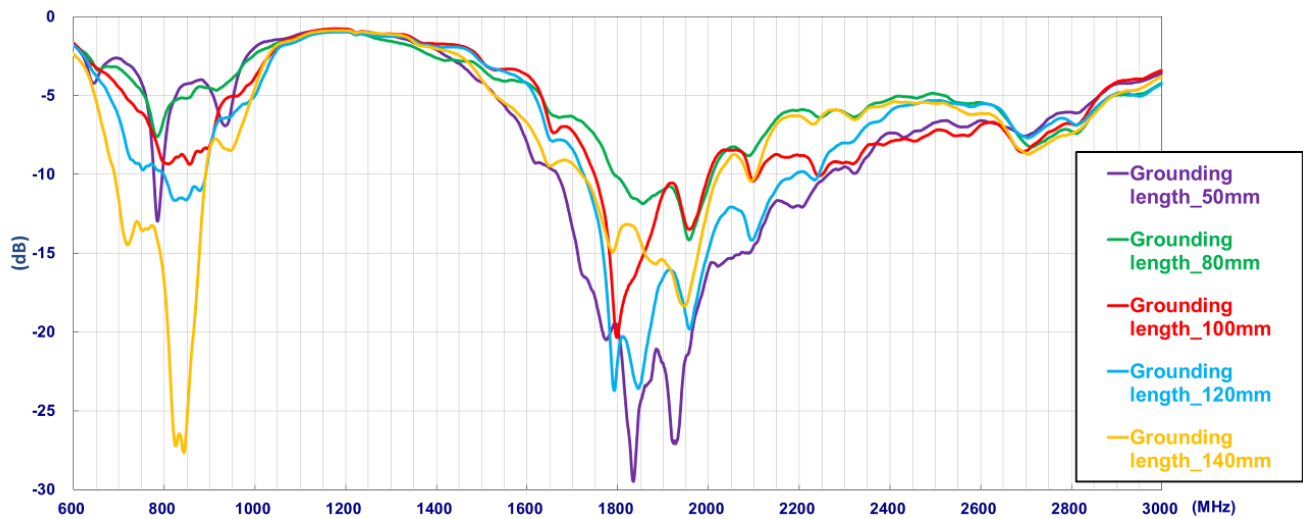

### 9.2 Efficiency

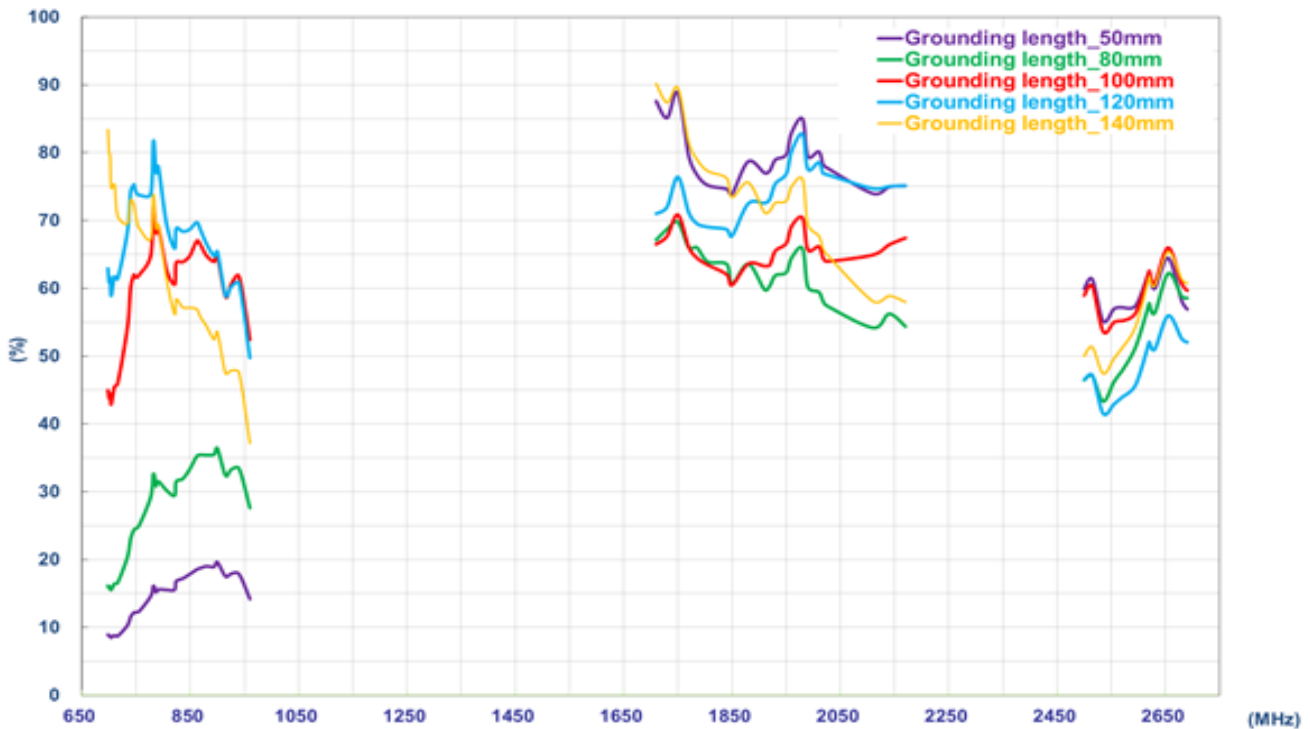

### 9.3 Peak Gain

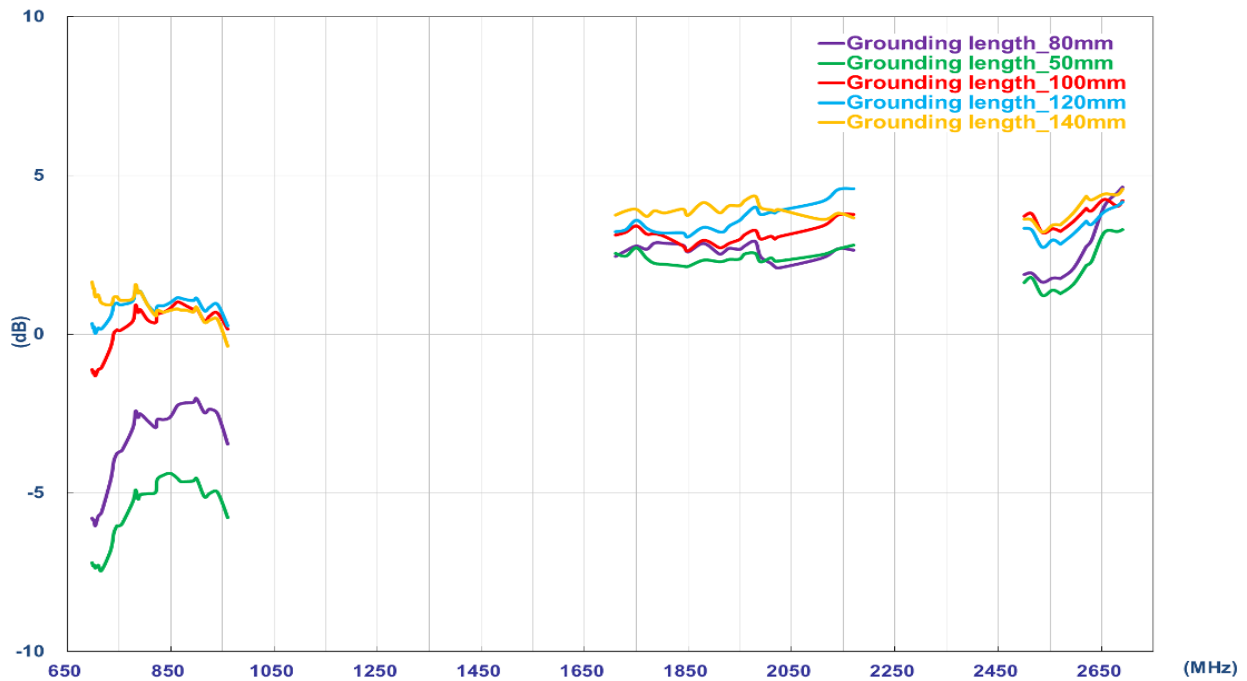

### 9.4 Average Gain

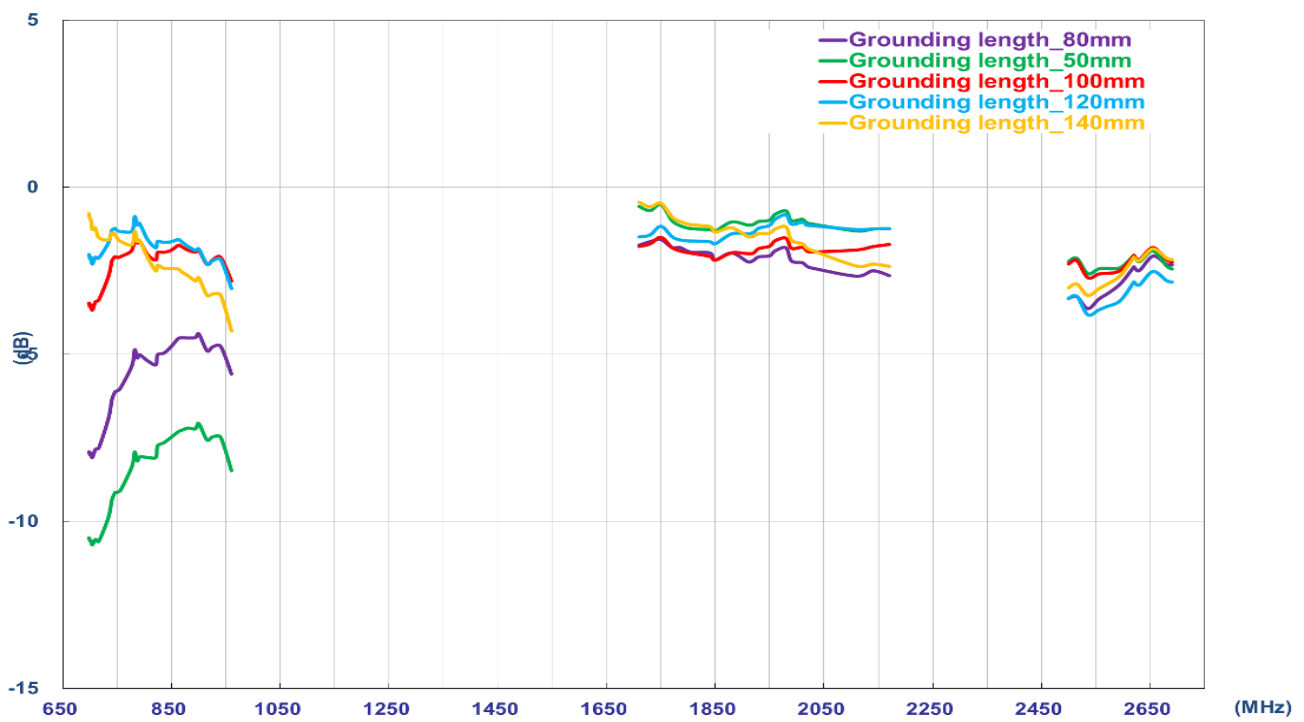



Changelog for the datasheet

**SPE-17-8-036 – MCS6.A**

**Revision: F (Current Version)**

Date:	2023-03-13
Changes:	Antenna Integration Guide Added
Changes Made by:	Cesar Sousa

**Previous Revisions**

**Revision: E**

Date:	2021-09-14
Changes:	MSL, font and datasheet rev as it was listed as the "B" version.
Changes Made by:	Erik Landi

**Revision: D**

Date:	2019-07-25
Changes:	Template & EVB Drawing
Changes Made by:	Jack Conroy

**Revision: C**

Date:	2018-10-23
Changes:	Pads Amended
Changes Made by:	David Connolly

**Revision: B**

Date:	2017-08-08
Changes:	Drawing Updated
Changes Made by:	Andy Mahoney

**Revision: A (Original First Release)**

Date:	2017-08-10
Notes:	
Author:	Jack Conroy



**TAOGLAS**®

[www.taoglas.com](http://www.taoglas.com)

