

Features

- Advanced Trench MOSFET Process Technology
- Epoxy Meets UL 94 V-0 Flammability Rating
- Moisture Sensitivity Level 1
- Halogen Free. "Green" Device (Note 1)
- Lead Free Finish/RoHS Compliant ("P" Suffix Designates RoHS Compliant. See Ordering Information)

Maximum Ratings

- Operating Junction Temperature Range: -55°C to +150°C
- Storage Temperature Range: -55°C to +150°C
- Thermal Resistance: 89°C/W Junction to Ambient

Parameter	Symbol	Rating	Unit
Drain -Source Voltage	V_{DS}	-30	V
Gate -Source Voltage	V_{GS}	±20	V
Drain Current-Continuous	I_D	-9.1	A
Drain Current-Pulsed	I_{DM}	-36	A
Power Dissipation	P_D	1.4	W
Single Pulsed Avalanche Energy (Note 2)	E_{AS}	20	mJ

Note:

1. Halogen free "Green" products are defined as those which contain <900ppm bromine, <900ppm chlorine (<1500ppm total Br + Cl) and <1000ppm antimony compounds.
2. EAS condition: $V_{DD} = -50V, L = 0.5mH, R_G = 25\Omega$, Starting $T_J = 25^\circ C$

Internal Structure and Marking Code

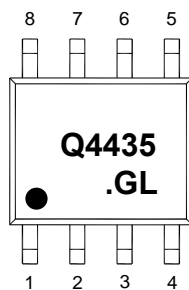
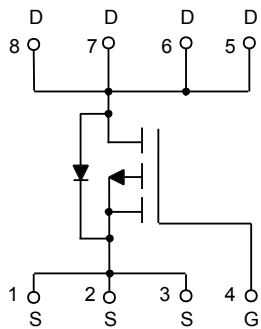

P-Channel Power MOSFET

SOP-8

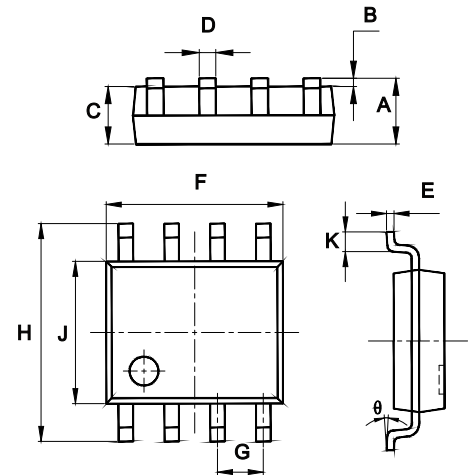

DIM	DIMENSIONS				NOTE
	INCHES		MM		
	MIN	MAX	MIN	MAX	
A	0.053	0.069	1.35	1.75	
B	0.004	0.010	0.10	0.25	
C	0.053	0.061	1.35	1.55	
D	0.013	0.020	0.33	0.51	
E	0.007	0.010	0.17	0.25	
F	0.185	0.200	4.70	5.10	
G	0.050		1.270		TYP.
H	0.228	0.244	5.80	6.20	
J	0.150	0.157	3.80	4.00	
K	0.016	0.050	0.40	1.27	
θ	0°	8°	0°	8°	

Suggested Solder Pad Layout

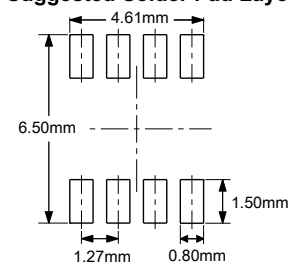

ELECTRICAL CHARACTERISTICS (Ta=25°C unless otherwise specified)

Parameter	Symbol	Test conditions	Min	Typ	Max	Unit
Static Characteristics						
Drain-Source Breakdown Voltage	$V_{(BR)DSS}$	$V_{GS}=0V, I_D=-250\mu A$	-30			V
Gate-Threshold Voltage	$V_{GS(th)}$	$V_{DS}=V_{GS}, I_D=-250\mu A$	-1.0	-1.5	-3.0	V
Gate-Body Leakage Current	I_{GSS}	$V_{GS}=\pm 20V, V_{DS}=0V$			± 100	nA
Zero Gate Voltage Drain Current	I_{DSS}	$V_{DS}=-30V, V_{GS}=0V$			-1	μA
Drain-Source On-Resistance	$R_{DS(on)}$	$V_{GS}=-10V, I_D=-9.1A$		14	24	m Ω
		$V_{GS}=-4.5V, I_D=-6.9A$		23	35	
Forward Transconductance	g_{FS}	$V_{DS}=-10V, I_D=-9.1A$	20			S
Dynamic Characteristics						
Input Capacitance	C_{iss}	$V_{DS}=-15V, V_{GS}=0V, f=1MHz$		1350		pF
Output Capacitance	C_{oss}			215		
Reverse Transfer Capacitance	C_{rss}			185		
Switching Characteristics						
Turn-On Delay Time	$t_{d(on)}$	$V_{DD}=-15V, I_D=-1.0A, V_{GS}=-10V, R_{GEN}=1\Omega, R_L=15\Omega$			15	nS
Turn-On Rise Time	t_r				15	
Turn-Off Delay Time	$t_{d(off)}$				70	
Turn-Off Fall Time	t_f				25	
Gate Resistance	R_g	$V_{DS}=0V, V_{GS}=0V, f=1MHz$		5.8		Ω
Total Gate Charge	Q_g	$V_{DS}=-15V, I_D=-9.1A, V_{GS}=-10V$			50	nC
		$V_{DS}=-15V, I_D=-9.1A, V_{GS}=-4.5V$			25	
Gate-Source Charge	Q_{gs}	$V_{DS}=-15V, I_D=-9.1A, V_{GS}=-4.5V$		4.0		
Gate-Drain Charge	Q_{gd}	$V_{DS}=-15V, I_D=-9.1A, V_{GS}=-4.5V$		7.5		
Drain-Source Diode Characteristics						
Diode Forward Voltage	V_{SD}	$V_{GS}=0V, I_S=-2A$			-1.2	V
Continuous Drain-Source Diode Forward Current	I_S				-9.1	A
Pulsed Drain-Source Diode Forward Current	I_{SM}				-36	A

Curve Characteristics

Fig. 1 - Output Characteristics

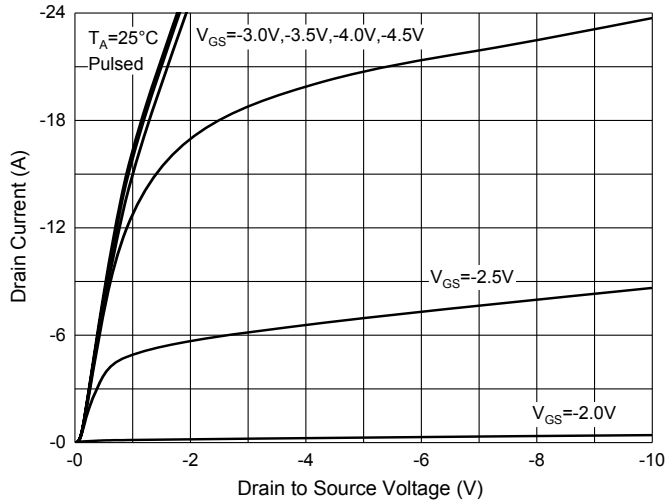

Fig. 2 - Transfer Characteristics

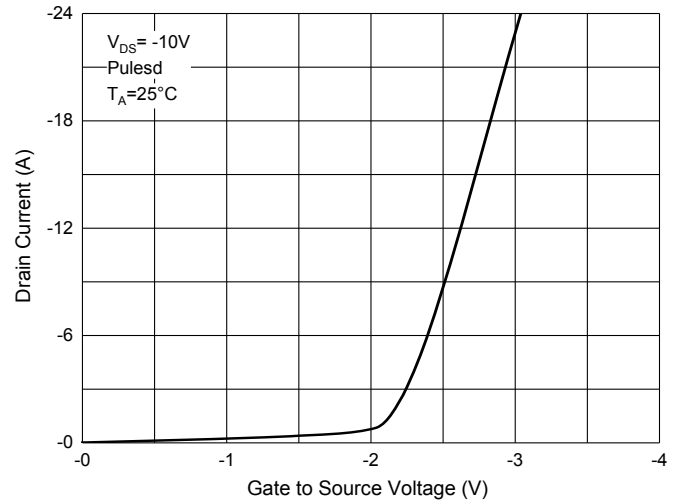

Fig. 3 - $R_{DS(ON)} - I_D$

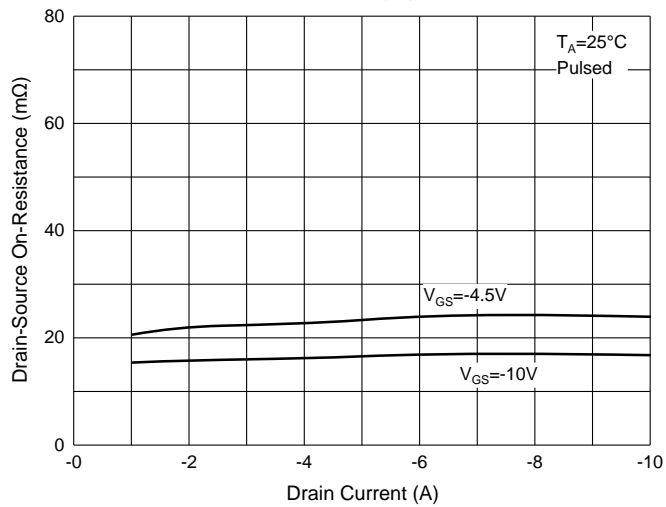

Fig. 4 - $R_{DS(ON)} - V_{GS}$

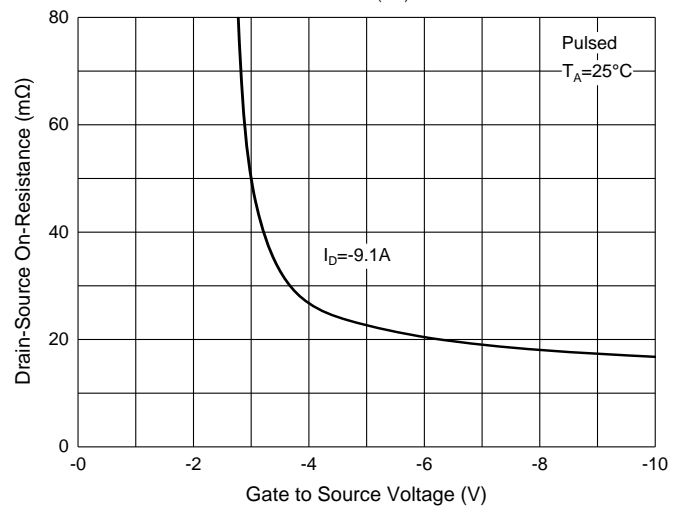

Fig. 5 - Threshold Voltage

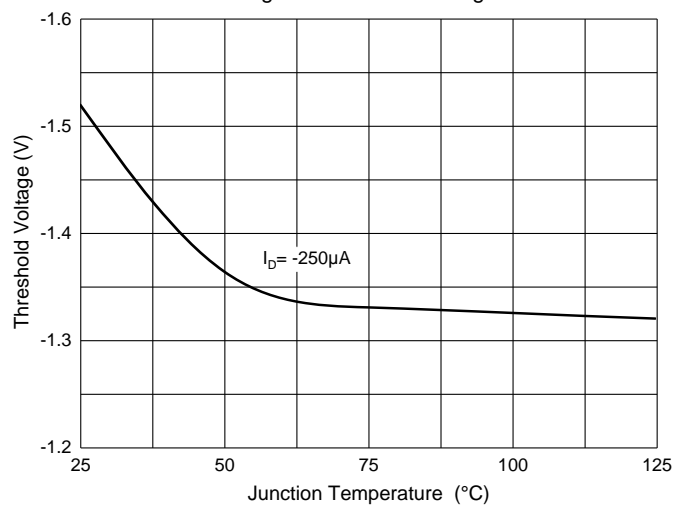
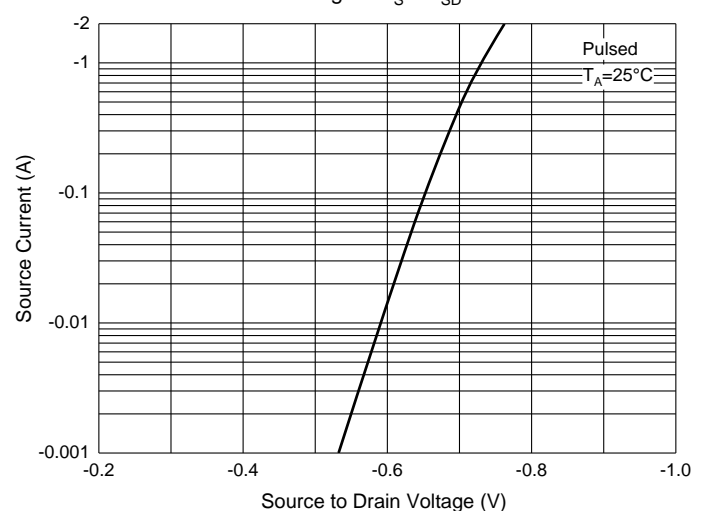

Fig. 6 - $I_S - V_{SD}$



Ordering Information

Device	Packing
Part Number-TP	Tape&Reel:4Kpcs/Reel

IMPORTANT NOTICE

Micro Commercial Components Corp. reserves the right to make changes without further notice to any product herein to make corrections, modifications, enhancements, improvements, or other changes. **Micro Commercial Components Corp.** does not assume any liability arising out of the application or use of any product described herein; neither does it convey any license under its patent rights, nor the rights of others. The user of products in such applications shall assume all risks of such use and will agree to hold **Micro Commercial Components Corp.** and all the companies whose products are represented on our website, harmless against all damages. **Micro Commercial Components Corp.** products are sold subject to the general terms and conditions of commercial sale, as published at <https://www.mccsemi.com/Home/TermsAndConditions>.

LIFE SUPPORT

MCC's products are not authorized for use as critical components in life support devices or systems without the express written approval of Micro Commercial Components Corporation.

CUSTOMER AWARENESS

Counterfeiting of semiconductor parts is a growing problem in the industry. Micro Commercial Components (MCC) is taking strong measures to protect ourselves and our customers from the proliferation of counterfeit parts. MCC strongly encourages customers to purchase MCC parts either directly from MCC or from Authorized MCC Distributors who are listed by country on our web page cited below. Products customers buy either from MCC directly or from Authorized MCC Distributors are genuine parts, have full traceability, meet MCC's quality standards for handling and storage. **MCC will not provide any warranty coverage or other assistance for parts bought from Unauthorized Sources.** MCC is committed to combat this global problem and encourage our customers to do their part in stopping this practice by buying direct or from authorized distributors.