

TYPICAL SWITCH ORDERING EXAMPLE

MB 2011 S B1 W 01 — D A

POLES & CIRCUITS			
2011	SPDT	ON	(ON)
2065	SPDT	ON	ON
2061	DPDT	ON	(ON)
2085	DPDT	ON	ON
2181	4PDT	ON	(ON)
2185	4PDT	ON	ON
() = Momentary			

CONTACT MATERIALS & RATINGS	
W	Silver Rated 6A @ 125V AC & 3A @ 250V AC
G	Gold Rated 0.4VA max. @ 28V AC/DC max.

CAPS	
B	.315" Dia.
C	.394" Dia.
D	.520" Dia.
E	.748" Dia.

PLUNGER TYPES	
S	Plunger for Screw-on Caps

TERMINALS	
01	Solder Lug
02	Quick Connect
03	.250" Straight PC
05	.425" Wirewrap
06	.750" Wirewrap
07	.964" Wirewrap
08	1.062" Wirewrap

CAP COLORS	
A	Black
B	White
C	Red
*E	Yellow
F	Green
*G	Blue
*H	Gray
* Not available with cap code E	

BUSHINGS	
B1	12mm Diameter Threaded with Keyway
B3	12mm Diameter Threaded with Splashproof

IMPORTANT:



Switches are supplied without UL & CSA marking unless specified. Specific models & ratings noted on General Specifications page.

DESCRIPTION FOR TYPICAL ORDERING EXAMPLE

MB2011SB1W01-DA

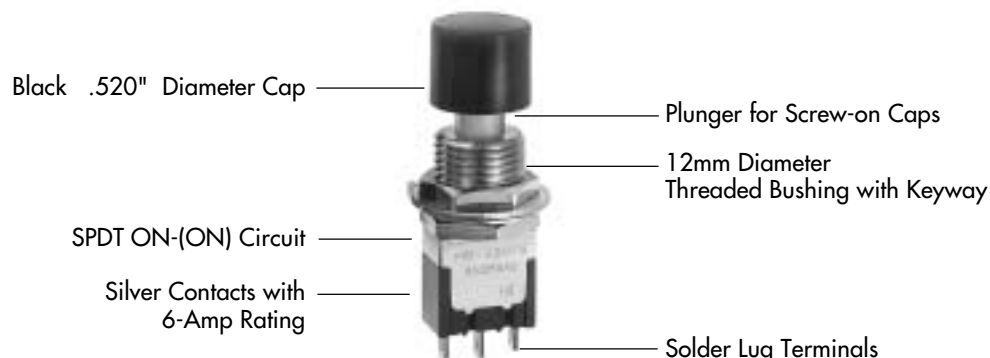

GENERAL SPECIFICATIONS

Electrical Capacity (Resistive Load)

- Power Level (code W):** 6A @ 125V AC & 3A @ 250V AC or 3A @ 30V DC
Logic Level (code G): 0.4VA maximum @ 28V AC/DC maximum
 Note: See Supplement Index (page Z1) to find explanation of operating range.

Other Ratings

- Contact Resistance:** 10 milliohms maximum for silver; 20 milliohms maximum for gold
Insulation Resistance: 1,000 megohms minimum @ 500V DC
Dielectric Strength: 1,000V AC minimum between contacts; 1,500V AC minimum between contacts & case
Mechanical Life: 50,000 operations minimum for splashproof models; 100,000 for all other models
Electrical Life: 25,000 operations minimum for silver at 100% power level;
 50,000 operations minimum for silver at 50% power level;
 50,000 operations minimum for gold
Nominal Operating Force: Momentary Action: 1-pole 950 grams; 2-pole 1,650 grams; 4-pole 2,400 grams;
 Alternate Action: 1-pole 450 grams; 2-pole 720 grams; 4-pole 1,200 grams
Plunger Travel:
- | | Screw-on Cap (Mom.) | Screw-on Cap (Alt.) |
|---------------|---------------------|---------------------|
| Pretravel: | 0.71 mm (.028") | 2.80 mm (.110") |
| Overtravel: | 1.09 mm (.043") | 1.10 mm (.043") |
| Total Travel: | 1.80mm (.071") | 3.90 mm (.153") |

Materials & Finishes

- Plunger:** Brass with nickel plating (with B3 bushing); polyacetal resin (with B1 bushing)
Bushing: Brass with nickel plating
Frame: Stainless steel
Case: Diallyl phthalate resin
Movable Contactor: Phosphor bronze with silver or gold plating
Movable Contacts: Silver alloy (code W); copper with gold plating over nickel plating (code G)
Stationary Contacts: Silver with silver plating (code W);
 copper or brass with gold plating over nickel plating (code G)
Terminals: Copper or brass with silver plating; copper or brass with gold plating over nickel plating

Environmental Data

- Operating Temp Range:** -30°C through +85°C (-22°F through +185°F)
Humidity: 90 ~ 95% humidity for 96 hours @ 40°C (104°F)
Vibration: 10 ~ 55 Hz with peak-to-peak amplitude of 1.5 mm traversing the frequency range & returning in 1 minute; 3 right angled directions for 2 hours
Shock: 50g acceleration (tested in 6 right angled directions, with 5 shocks in each direction)
Sealing: B3 bushing option equivalent to IP67













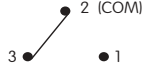

Installation

- Mounting Torque:** 15 kgf/cm (13 lb/in) for double nut; 7 kgf/cm (6 lb/in) for single nut
Cap Installation Force: 8.16 kg (18 lb) maximum downward force on actuator
Soldering Time & Temperature: 3 seconds @ 350°C or 5 seconds @ 270°C
Process Seal: Not available

Standards & Certifications

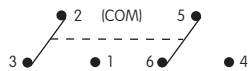
- Flammability Standards:** UL94V-0 available
UL Recognized: All models recognized at 6A @ 125V AC or 3A @ 250V AC or 0.4A @ 28V DC; UL File No. E44145
CSA Certified: All models certified at 6A @ 125V AC or 3A @ 250V AC or 0.4VA @ 28V maximum; CSA File No. LR23535

POLES & CIRCUITS

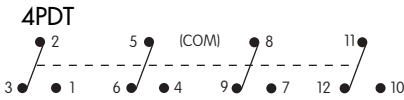
Pole	Model	Plunger Position () = Momentary		Connected Terminals		Throw & Schematics
		Normal 	Down 	Normal 	Down 	
SP	MB2011 MB2065	ON 	(ON) ON	2-3 	2-1 	SPDT 
DP	MB2061 MB2085	ON 	(ON) ON	2-3 5-6 	2-1 5-4 	DPDT 
4P	MB2181 MB2185	ON 	(ON) ON	2-3 5-6 8-9 11-12 	2-1 5-4 8-7 11-10 	4PDT 

PLUNGER TYPES

S Plunger for Screw-on Caps

Plunger is plastic for B1 bushing.

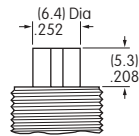

Plunger is metal for B3 bushing.

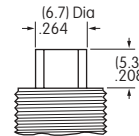

On alternate action models, after transferring circuit, the plunger returns to its original position, and does not latch down.

BUSHINGS

B1 12mm Diameter Threaded with Keyway

Max. effective panel thickness with standard hardware 5.5 mm (.217")

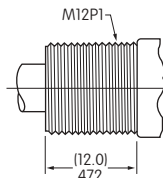
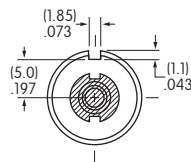

B3 12mm Diameter Threaded Splashproof

Max. effective panel thickness with standard hardware 5.5 mm (.217")

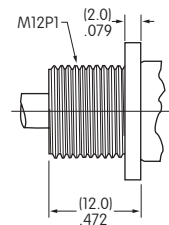
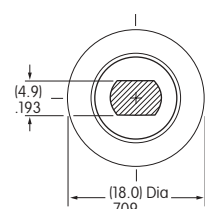

Panel Cutouts

For B1 Bushing with Keyway

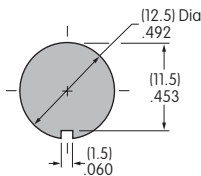

For B1 Bushing with Locking Ring

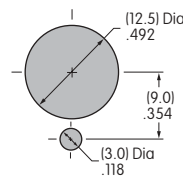

For B3 Bushing without Keyway

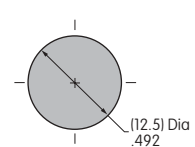

CONTACT MATERIALS & RATINGS

W Silver over Silver

Power Level

6A @ 125V AC & 3A @ 250V AC

G Gold over Brass or Copper

Logic Level

0.4VA maximum @ 28V AC/DC maximum

Note: See Supplement Index (page Z1) to find complete explanation of operating range.

TERMINALS

01 Solder Lug

The .043" X .079" oblong hole accommodates 1 solid 18-gauge wire or 2 solid or stranded 20-gauge wires.

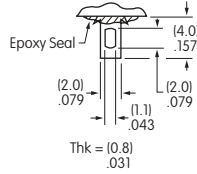

02 .062" Wide Quick Connect

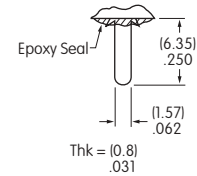

03 .250" Straight PC

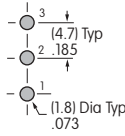
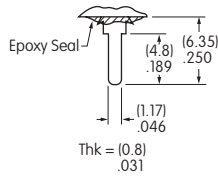

Single Pole

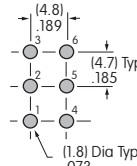

Double Pole

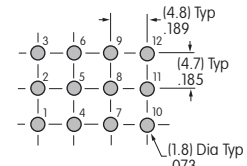

Four Pole

05 .425" (10.8mm) Wirewrap or Extended PC

06 .750" (19.05mm) Wirewrap or Extended PC

07 .964" (24.5mm) Wirewrap or Extended PC

08 1.062" (27.0mm) Wirewrap or Extended PC

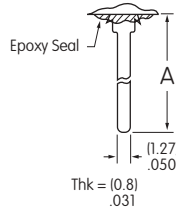

If using as extended PC terminal, refer to the above footprints.

Dimension A = terminal lengths as shown beside the terminal codes at the left.

CAPS & CAP COLORS

B AT078 .315" Dia. Cap

Material: Polystyrene
Finish: Glossy



Colors Available: A B C E F G H

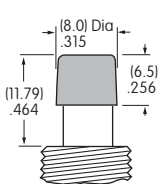

C AT079 .394" Dia. Cap

Material: Polystyrene
Finish: Glossy



Colors Available: A B C E F G H

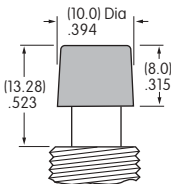

D AT414 .520" Dia. Cap

Material: PBT
Finish: Glossy



Colors Available: A B C E F G H

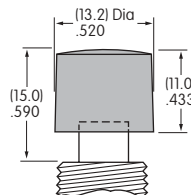

E AT412 .748" Dia. Cap

Material: Polystyrene
Finish: Glossy



Colors Available: A B C F

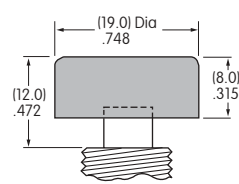

Cap Color Codes:



Black



White



Red



Yellow



Green



Blue



Gray

TYPICAL SWITCH DIMENSIONS

Solder Lug

Single Pole

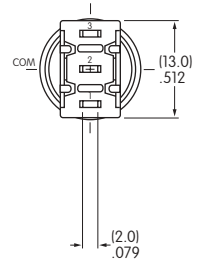
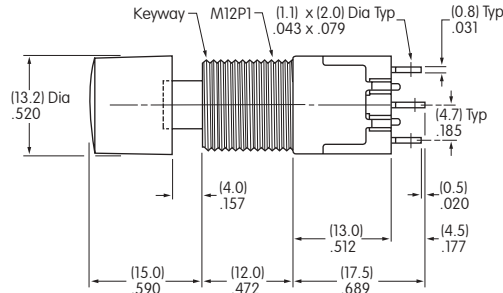
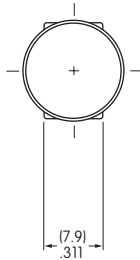

MB2011SB1W01-DA

Solder Lug

Double Pole

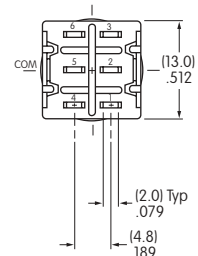
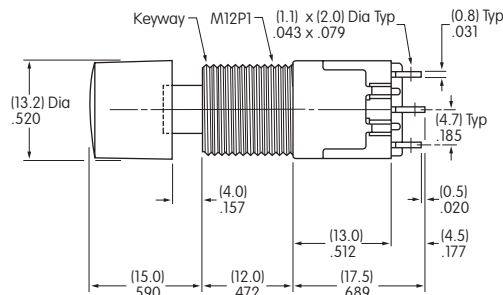
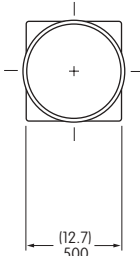

MB2061SB1W01-DA

Solder Lug

Four Pole

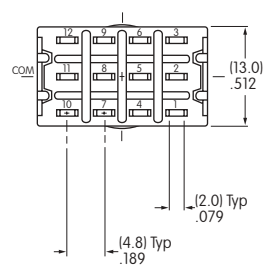
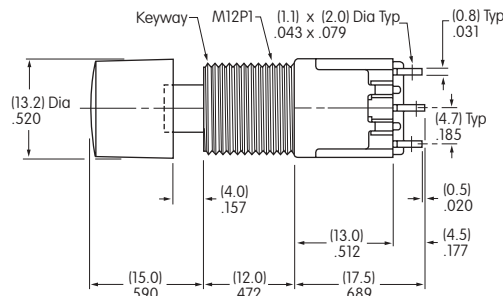
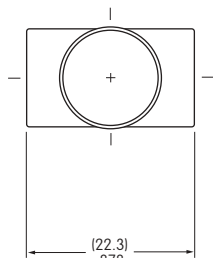

MB2181SB1W01-DA

HARDWARE

Standard Hardware for B1 Bushing

AT503M Hex Face Nut

Material:
Brass with tin plating

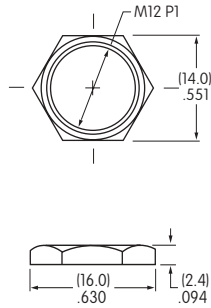

AT508 Lockwasher

Material:
Steel with zinc plating

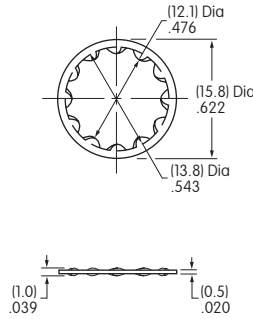

AT527M Hex Nut

Material:
Steel with nickel plating

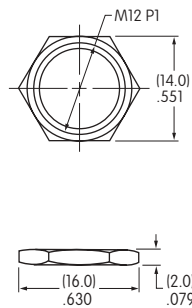

AT506 Locking Ring

Material:
Steel with zinc plating

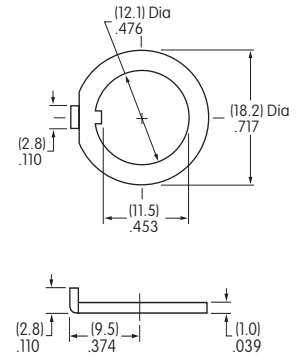

Standard Hardware for B3 Bushing

AT503M Hex Face Nut

Material:
Brass with tin plating

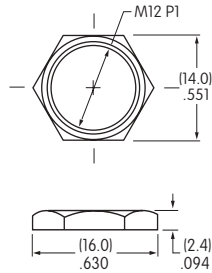

AT537 O-ring

Material:
Nitrile butadiene rubber (NBR)

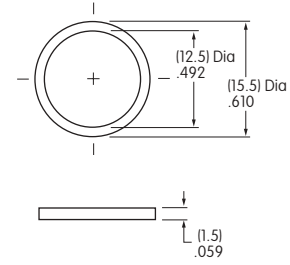

Optional Splashproof Boot

AT4043 Splashproof Boot

Material: Silicone Rubber
Operating Life: 10,000 for momentary
30,000 for alternate action

When using a splashproof boot, no cap is required.

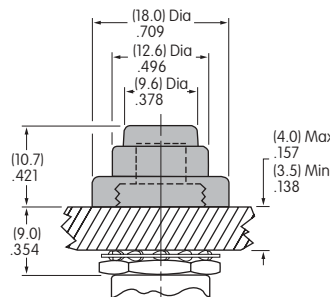

CUSTOM ASSEMBLY ORDERING EXAMPLE

The MB2000 pushbutton series offers flexibility to accommodate a variety of applications. Using a basic large bushing model, different accessories can be assembled onto the switch to achieve the mounting variations shown on the following two pages.

- These switches have:
- 12mm diameter threaded bushing with keyway
 - Silver contacts
 - 6 Amp rating
 - Solder lug terminals

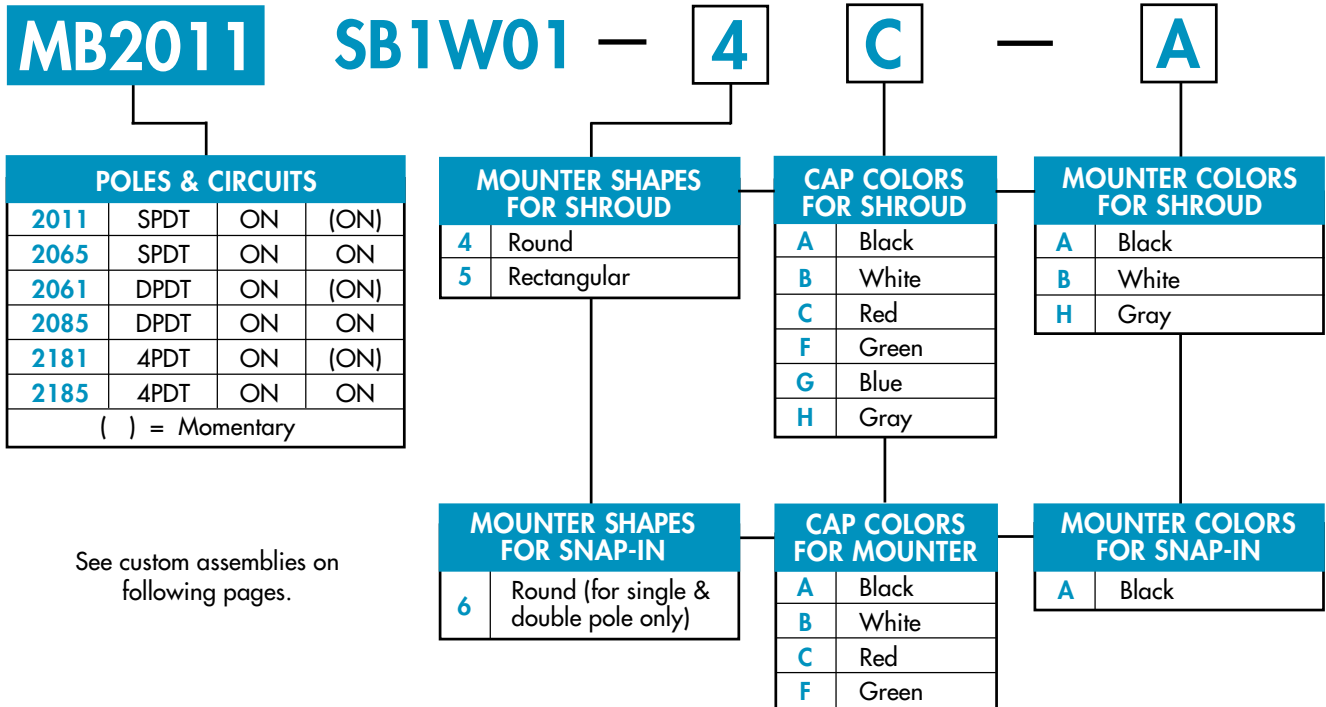

Round Shroud
MB2011SB1W01-4C-A



Rectangular Shroud
MB2011SB1W01-5C-A



Snap-in Mounter
MB2011SB1W01-6C-A

CUSTOM ASSEMBLY WITH ROUND SHROUD



MB2011SB1W01-4C-A

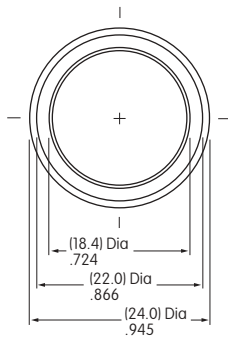

Single Pole

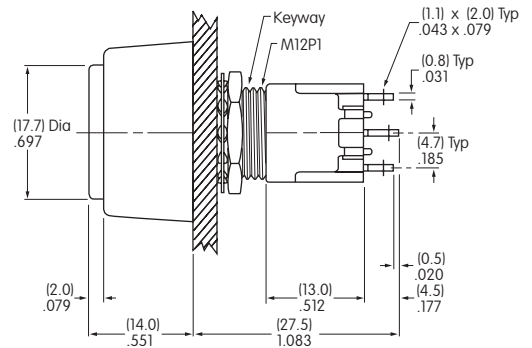

Double Pole

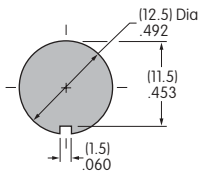

Effective Panel Thickness:
5.5 mm (.217") max.

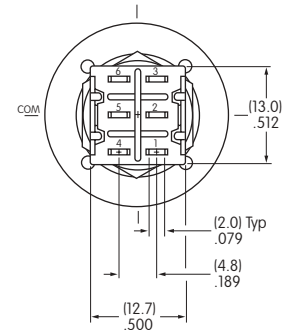
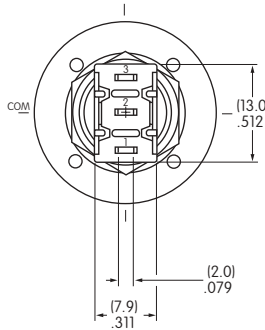

CUSTOM ASSEMBLY WITH RECTANGULAR SHROUD



MB2011SB1W01-5C-A

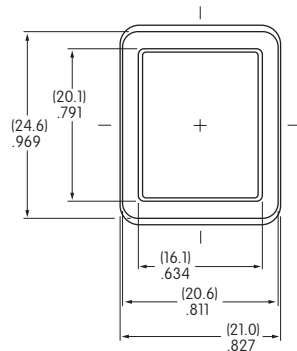

Single Pole

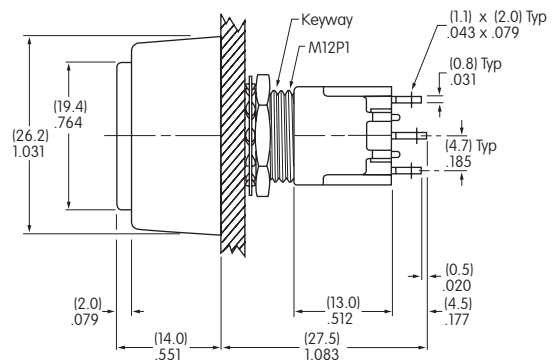

Double Pole

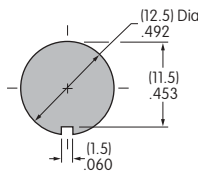

Effective Panel Thickness:
5.5 mm (.217") max.

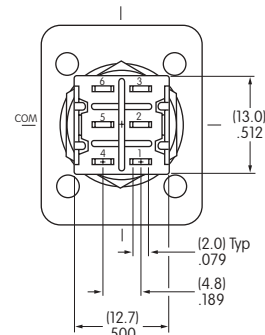
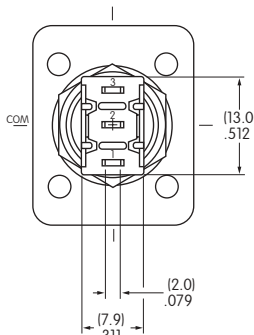

CUSTOM ASSEMBLY WITH SNAP-IN MOUNTER



MB2011SB1W01-6C-A

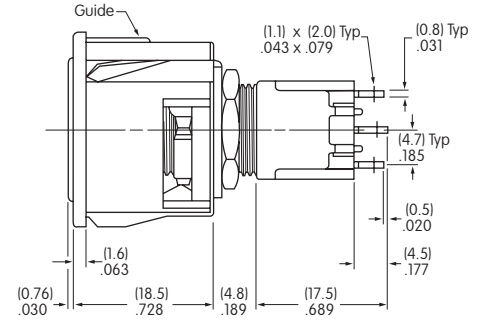
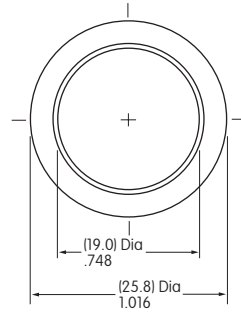

Single Pole

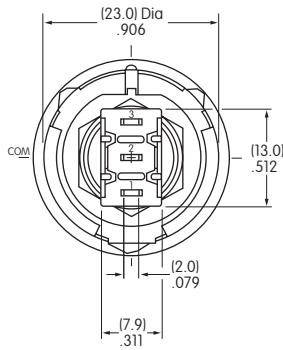

Double Pole

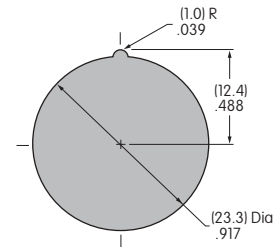
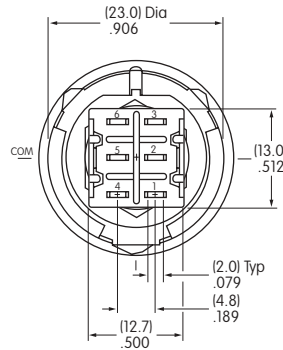

Mouser is fiberglass reinforced nylon
 Only available in Black
 Panel thickness:
 1.0 ~ 4.0mm (.039" ~ .157")