

MAX6889 Evaluation Kit/ Evaluation System

Evaluate: MAX6889/MAX6892

General Description

The MAX6889 evaluation system (EV system) consists of a MAX6889 evaluation kit (EV kit) and a Maxim CMAXQUSB command module. The MAX6889/MAX6892 EEPROM-configurable, multivoltage power-supply sequencers/supervisors monitor several voltage-detector inputs, two auxiliary inputs, and four general-purpose logic inputs and feature programmable outputs for highly configurable power-supply sequencing applications. The evaluation software runs under Windows® 98/2000/XP, providing a handy user interface to exercise the features of the MAX6889.

Order the complete EV system (MAX6889EVCMAXQU) for comprehensive evaluation of the MAX6889 using a personal computer. Order the EV kit (MAX6889EVKIT) if the command module has already been purchased with a previous Maxim EV system or for custom use in other microcontroller (μ C)-based systems.

This system can also evaluate the MAX6892. Contact factory for a free sample of MAX6892ETJ.

MAX6889 Stand-Alone EV Kit

The MAX6889 EV kit provides a proven PC board layout to facilitate evaluation of the MAX6889. It must be interfaced to appropriate timing signals for proper operation. Connect 3.3V power, ground-return, and SCL/SDA interface signals to the breakout header pins (see Figure 9). The LEDs are optional circuits, which may be powered separately or disabled altogether. Refer to the MAX6889 data sheet for timing requirements.

MAX6889 EV System

The MAX6889 EV system obtains power from the computer's USB port. The evaluation software runs under Windows 98/2000/XP on an IBM PC, interfacing to the EV system board through the computer's USB port. See the *Quick Start* section for setup and operating instructions.

Windows is a registered trademark and registered service mark of Microsoft Corporation.

Features

- Proven PC Board Layout
- Complete Evaluation System
- Convenient On-Board Test Points
- Fully Assembled and Tested

Ordering Information

PART	TEMP RANGE	INTERFACE TYPE
MAX6889EVKIT	0°C to +70°C	User-supplied
MAX6889EVCMAXQU#	0°C to +70°C	Windows software, USB

#Denotes ROHS compliant with exemption.

Note: The MAX6889 evaluation software is designed for use with the complete evaluation system MAX6889EVCMAXQU (includes CMAXQUSB module together with MAX6889EVKIT). If the MAX6889 evaluation software will not be used, the MAX6889EVKIT board can be purchased by itself, without the CMAXQUSB module.

Component List

MAX6889EVCMAXQU System

PART	QTY	DESCRIPTION
MAX6889EVKIT	1	MAX6889 evaluation kit
CMAXQUSB	1	Command module

MAX6889EVKIT

DESIGNATION	QTY	DESCRIPTION
C1, C2	2	1 μ F, 6.3V X7R ceramic capacitors (0603) TDK C1608X7R0J105K
C3–C10	8	0.1 μ F, 25V X7R ceramic capacitors (0603) TDK C1608X7R1E104K
C11, C12	0	Not installed, capacitors (0603)
H1–H4	4	8-pin headers
JU1, JU12–JU21	11	2-pin headers
JU2–JU11	10	3-pin headers
LED1–LED10	10	LEDs, red (T1-3/4)
P1	1	2 x 10 right-angle receptacle
R1–R10	10	470 Ω \pm 5% resistors (0805)
U1	1	MAX6889ETJ (32-pin thin QFN)
None	17	Shunts
None	1	MAX6889 EV kit PC board

Component Suppliers

SUPPLIER	PHONE	FAX	WEBSITE
TDK	847-803-6100	847-390-4405	component.tdk.com

Note: Indicate you are using the MAX6889 when contacting this component supplier.

Quick Start

Required Equipment

Before you begin, the following equipment is needed:

- Maxim MAX6889EVCMAXQU (contains MAX6889 EV kit board and CMAXQUSB module)
- USB-A-B cable (included with CMAXQUSB module)
- Windows 98/2000/XP computer with a USB port
- Administrator privileges may be required when first installing the device on Windows 2000/XP

Procedure

Do not turn on the power until all connections are made:

- 1) Set the CMAXQUSB's **VDD Select** jumper to **3.3V**.
- 2) Ensure that the MAX6889 EV kit's JU1 is in 1-2 position, JU2–JU5 are open, JU6–JU10 are in 2-3 position, JU11–JU21 are in 1-2 position, and JU22 is intact. See *Jumper Function Tables* section.
- 3) Carefully connect the boards by aligning the 20-pin header of the MAX6889 EV kit with the 20-pin connector of the CMAXQUSB module. Gently press them together. The two boards should be flush against one another.
- 4) Install the evaluation software on your computer by running the INSTALL.EXE program on the disk. The program files are copied and icons are created for them in the Windows Start Menu.
- 5) Connect the USB cable between the CMAXQUSB and the computer. The plug-and-play system automatically launches the New Hardware Wizard to find the device drivers on the installation disk. When prompted for a device driver, navigate to the directory where the software was installed (C:\MAX6889).
- 6) Start the MAX6889 program by opening its icon in the Start Menu.
- 7) If supplies exceeding V_{CC} are applied to IN1–IN5 while V_{CC} source = 0, the part will be damaged. Click on **V_{CC} source** control at the bottom left of block diagram (Figure 1) to toggle **V_{CC} source** bit.

Detailed Description of Software

Main Window

The evaluation software's main window shows a block diagram of the MAX6889, with many "clickable" features (Figure 1). Clicking on different parts of the block diagram leads to different feature tabs. Clicking **Back** returns to the main window's block diagram tab.

Configuration register changes made with the GUI are written when the **Apply** button is clicked. Configuration of the device may be re-read by clicking **Refresh**.

Press function key F1 at any time to return to the block diagram. Press function key F2 to pop-up a window displaying registers pertinent to the selected feature (Figure 2). The software reads the data registers automatically, unless disabled by unchecking **Poll inputs every 2 seconds** under the **Options** menu.

At startup, the evaluation software reads the device configuration from the device registers.

Voltage Monitor Tab

The **Voltage Monitor** tab configures voltage monitor thresholds (Figure 3).

High-impedance mode requires installing external resistor-dividers. A prototype area is provided on the EV kit for this purpose.

Digital Inputs Tab

Digital inputs GPI1–GPI4 can be configured for active-high or active-low logic (Figure 4). When a GPI_ pin is configured active-high, a logic-high level asserts the corresponding GPI_ input.

Outputs Tab

The PO_ signals assert when a selected combination of other signals become asserted (Figure 5). The voltage monitors and the watchdog timer are internal signals. The GPI_ pins and MR are external inputs.

When a PO_ signal is asserted, several actions may occur. The corresponding PO_ pin can be driven to a high or low logic level. The pin driver can be configured as open-drain or as a push-pull output.

User EEPROM writes may optionally be locked out when the PO_ is asserted.

The MARGIN signal allows user system testing, by forcing the PO_ signal to hold its previously determined state. It is expected that MARGIN will be high during normal operation.

Watchdog Timer Tab

The watchdog timer asserts a fault condition after a period of time, unless the timer is periodically reset by an input pin being toggled (Figure 6).

During normal operation, an enabled watchdog timer must be serviced by toggling a GPI pin periodically. Typically an external piece of firmware would service the watchdog timer by toggling a GPI pin inside a loop, and watchdog timer assertion would be configured to drive a PO_ output pin. Any software defect that halts the firmware then causes the watchdog timer to assert.

The initial timeout period can be set to a longer value, to allow time for software initialization. Alternatively, the watchdog timer can be held in reset by an optional “clear” input. Refer to the MAX6889 data sheet for more information about watchdog timer operation.

Registers Tab

The **Registers** tab displays the volatile working registers of the MAX6889 (Figure 7). Pressing **Refresh** reads and displays all register values. Individual register bytes can be modified by selecting the appropriate grid cell and typing zero-x prefix “0x” followed by two hexadecimal digits 0–9/A–F. If **Options** menu item **Confirm REG write when editing** is checked, a dialog box appears to confirm each byte written in this manner.

At power-up, the MAX6889 automatically loads its registers from the configuration EEPROM. To store the active register values into the configuration EEPROM, press **Commit to EEPROM**.

Register values can optionally be stored into a text file on disk for later retrieval, using the **Load from File** and **Save to File** buttons.

EEPROM Tab

The **EEPROM** tab displays the nonvolatile EEPROM memory of the MAX6889 (Figure 8). Pressing **Refresh** reads and displays the selected EEPROM page. Individual memory bytes can be modified by selecting the appropriate grid cell and typing zero-x prefix “0x” followed by two hexadecimal digits 0–9/A–F. If **Options** menu item **Confirm EEPROM write when editing** is checked, a dialog box appears to confirm each byte written in this manner.

EEPROM values can optionally be stored into a text file on disk for later retrieval, using the **Load from File** and **Save to File** buttons.

Detailed Description of Hardware

The MAX6889 (U1) is surrounded by breakout header pins H1–H4. Capacitors C1 and C2 bypass the power supply. The user power-supply inputs IN1–IN8 are bypassed by capacitors C3–C10.

Connector P1 mates with the CMAXQUSB module, which enables communication with software running on a PC (there are SCL/SDA pullup resistors on the module board). As a convenience, the module also provides power to U1 through jumper JU1. This same power supply also powers most of the EV kit LEDs through jumper JU2.

Programmable outputs PO1–PO10 drive optional active-low LED indicators. When the LED is on, that indicates that the corresponding PO output is low.

Capacitors C11 and C12 are left open when used with the MAX6889. These component sites are provided to support the MAX6892.

Evaluating the MAX6892

The software and the CMOD board cannot be used with the MAX6892; the board must be operated in stand-alone mode.

- 1) With power off, replace U1 with a MAX6892ETJ.
- 2) Install user-selected EIA size 0603 capacitors for SWT and SRT at locations C11 and C12. Refer to the *Applications Information* section in the MAX6892 data sheet.
- 3) Configure jumpers JU4–JU11 according to Table 3, Jumper Function Table in the MAX6892 data sheet.
- 4) Inputs IN2–IN8 require user-selected resistor-dividers, which may be installed in the prototype area.
- 5) Apply power between V_{CC} and GND.

The functions of the following pins change as follows:

PIN	MAX6889ETJ	MAX6892ETJ	CONTROLLED BY
1	PO2	PG2	—
2	PO3	PG3	—
3	PO4	PG4	—
5	PO5	PG5	—
6	PO6	PG6	—
7	PO7	PG7	—
8	PO8	PG8	—
9	PO9	$\overline{\text{RESET}}$	—
10	PO10	$\overline{\text{WDO}}$	—
11	$\overline{\text{MARGIN}}$	MARGIN	JU2
12	$\overline{\text{MR}}$	MR	JU3
13	SDA	TH0	JU4
14	SCL	TH1	JU5
15	A0	TH2	JU6
16	A1	TH3	JU7
17	GPI4	TH4	JU8
18	GPI3	SWT	JU9, C12
19	GPI2	SRT	JU10, C11
20	GPI1	$\overline{\text{ENABLE}}$	JU11
23	IN8	IN8	—
24	IN7	IN7	—
25	IN6	IN6	—
26	IN5	IN5	—
31	N.C.	WDI	—
32	PO1	PG1	—

Diagnostics Window

The diagnostics window is used for factory testing prior to shipping the evaluation kit. It is not meant for customer use.

Table 1. Jumper Function Table for MAX6889

JUMPER	PIN	POSITION	FUNCTION
JU1	V _{CC}	Open	U1 must be powered by a user-supplied external supply connected to IN1–IN5.
		Closed*	U1 input V _{CC} is powered from connector P1 power supply (the CMAXQUSB module). Ensure that CMAXQUSB's VDD select jumper is in the 3.3V position.
JU2	$\overline{\text{MARGIN}}$	1-2	$\overline{\text{MARGIN}}$ connected to DPB.
		Open*	Normal operation.
		2-3	User test mode. PO outputs are held in their previously configured states.
JU3	$\overline{\text{MR}}$	1-2	$\overline{\text{MR}}$ connected to DPB.
		Open*	Normal operation.
		2-3	Manual reset.
JU4	SDA	1-2	Do not use.
		Open*	Normal operation.
		2-3	Do not use.
JU5	SCL	1-2	Do not use.
		Open*	Normal operation.
		2-3	Do not use.
JU6	A0	1-2	A0 = 1.
		Open	Do not use.
		2-3*	A0 = 0.
JU7	A1	1-2	A1 = 1.
		Open	Do not use.
		2-3*	A1 = 0.
JU8	GPI4	1-2	Input GPI4 is driven high.
		Open	Input GPI4 can be driven by external user circuitry.
		2-3*	Input GPI4 is driven low.
JU9	GPI3	1-2	Input GPI3 is driven high.
		Open	Input GPI3 can be driven by external user circuitry.
		2-3*	Input GPI3 is driven low.
JU10	GPI2	1-2	Input GPI2 is driven high.
		Open	Input GPI2 can be driven by external user circuitry.
		2-3*	Input GPI2 is driven low.
JU11	GPI1	1-2*	Input GPI1 is driven high.
		Open	Input GPI1 can be driven by external user circuitry.
		2-3	Input GPI1 is driven low.
JU12–JU21	PO1–PO10	Closed*	Outputs PO1–PO10 drive corresponding active-low LED indicators LED1–LED10.
		Open	Corresponding PO1–PO10 output available to drive user circuitry.
JU22	—	Closed* (PC board trace)	LED1–LED16 are powered from connector P1 power supply (the CMAXQUSB module).
		Open	LED1–LED16 are unused, or can be externally powered.

*Default configuration.

Table 2. Jumper JU6, JU7 (MAX6889 Only: Device Address Selection)

JU6 SHUNT POSITION	JU7 SHUNT POSITION	A0	A1	DEVICE ADDRESS
2-3*	2-3*	0	0	1010 00x r/w
1-2	2-3	1	0	1010 01x r/w
2-3	1-2	0	1	1010 10x r/w
1-2	1-2	1	1	1010 11x r/w

*Default configuration.

Table 3. Jumper Function Table for MAX6892

JUMPER	PIN	POSITION	FUNCTION
JU1	V _{CC}	Open	U1 must be powered by a user-supplied external supply connected to IN1–IN5.
		Closed*	U1 input V _{CC} is powered from connector P1 power supply.
JU2	$\overline{\text{MARGIN}}$	1-2	$\overline{\text{MARGIN}}$ connected to DPB.
		Open*	Normal operation.
		2-3	User test mode. PG outputs are held in their previously configured states.
JU3	$\overline{\text{MR}}$	1-2	$\overline{\text{MR}}$ connected to DPB.
		Open*	Normal operation.
		2-3	Manual reset.
JU4	TH0	1-2	TH0 = 1.
		Open*	Do not use.
		2-3	TH0 = 0.
JU5	TH1	1-2	TH1 = 1.
		Open*	Do not use.
		2-3	TH1 = 0.
JU6	TH2	1-2	TH2 = 1.
		Open	Do not use.
		2-3*	TH2 = 0.
JU7	TH3	1-2	TH3 = 1.
		Open	Do not use.
		2-3*	TH3 = 0.
JU8	TH4	1-2	TH4 = 1.
		Open	Do not use.
		2-3*	TH4 = 0.
JU9	SWT	1-2	SWT = 1 (default watchdog timeout period).
		Open	User-installed C11 determines SWT time value.
		2-3*	SWT = 0 (watchdog disabled).

*Default configuration.

Table 3. Jumper Function Table for MAX6892 (continued)

JUMPER	PIN	POSITION	FUNCTION
JU10	SRT	1-2	SRT = 1 (default reset timeout period).
		Open	User-installed C12 determines SRT time value.
		2-3*	SRT = 0 (reset asserted).
JU11	$\overline{\text{ENABLE}}$	1-2*	$\overline{\text{ENABLE}} = 1$ (force all PG outputs low).
		Open	User-supplied signal overrides internal pulldown.
		2-3	$\overline{\text{ENABLE}} = 0$ (PG determined by input conditions).
JU12–JU21	PG1–PG10	Closed*	Outputs PG1–PG10 drive corresponding active-low LED indicators LED1–LED10.
		Open	Corresponding PG1–PG10 output available to drive user circuitry.
JU22	—	Closed* (PC board trace)	LED1–LED16 are powered from connector P1 power supply (the CMAXQUSB module).
		Open	LED1–LED16 are unused, or can be externally powered.

*Default configuration.

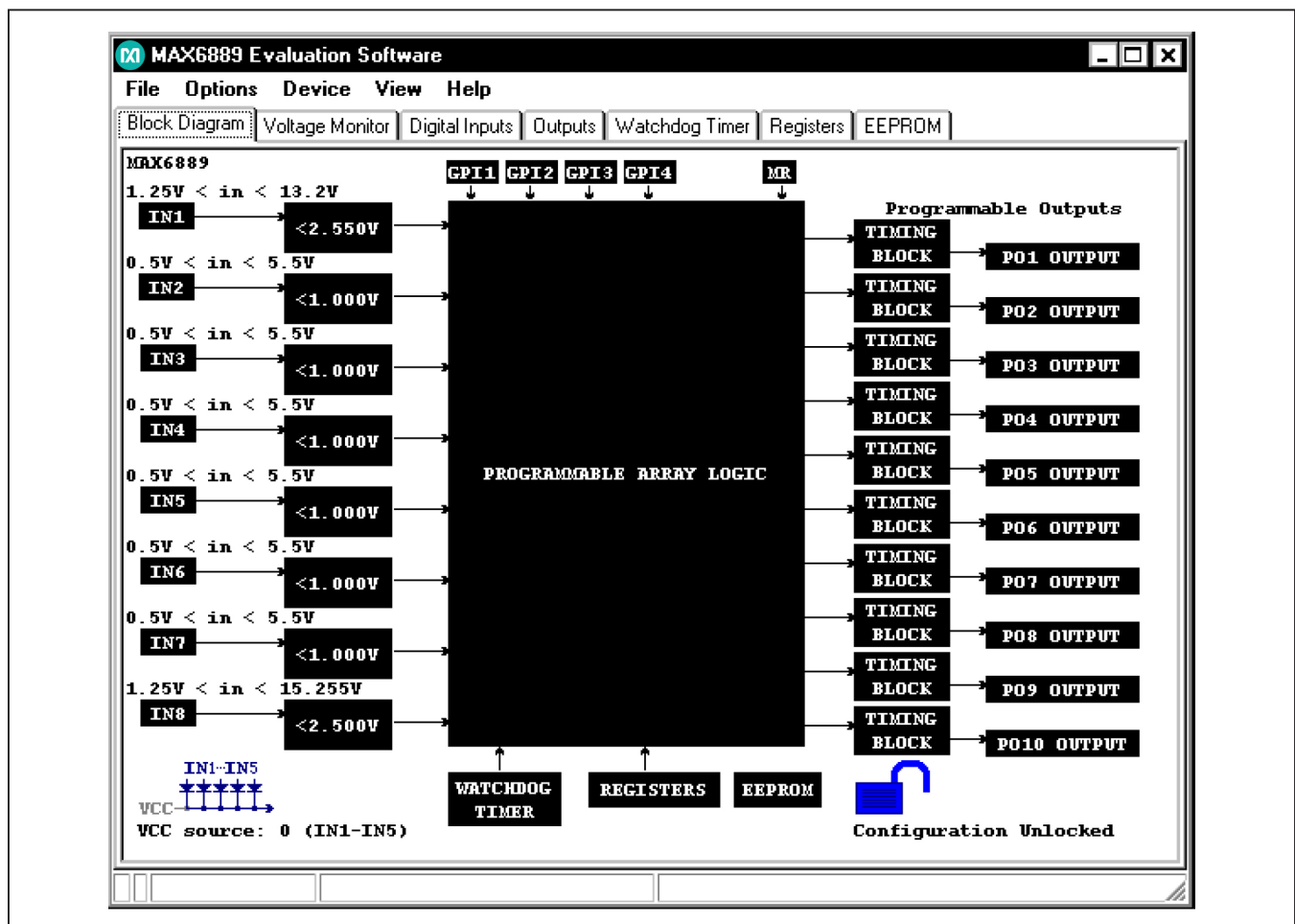

Figure 1. Block Diagram (Bring Up Anytime by Pressing Function Key F1)

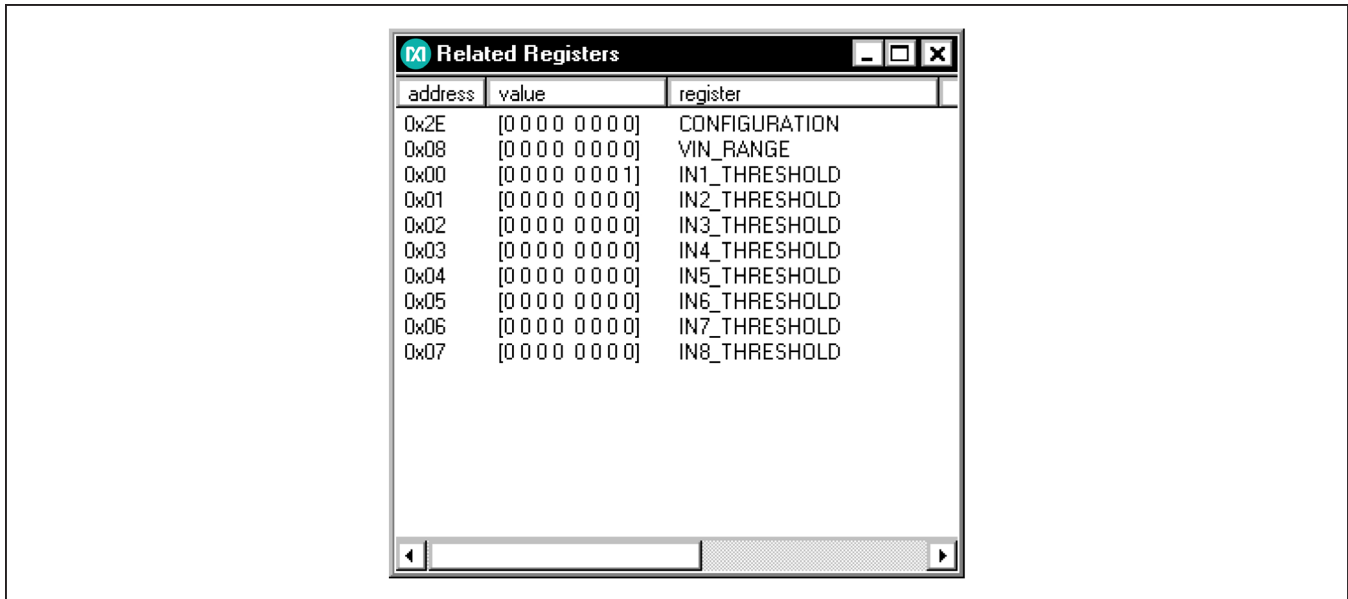

Figure 2. Related Registers Adjunct Window (Shown by Pressing Function Key F2)

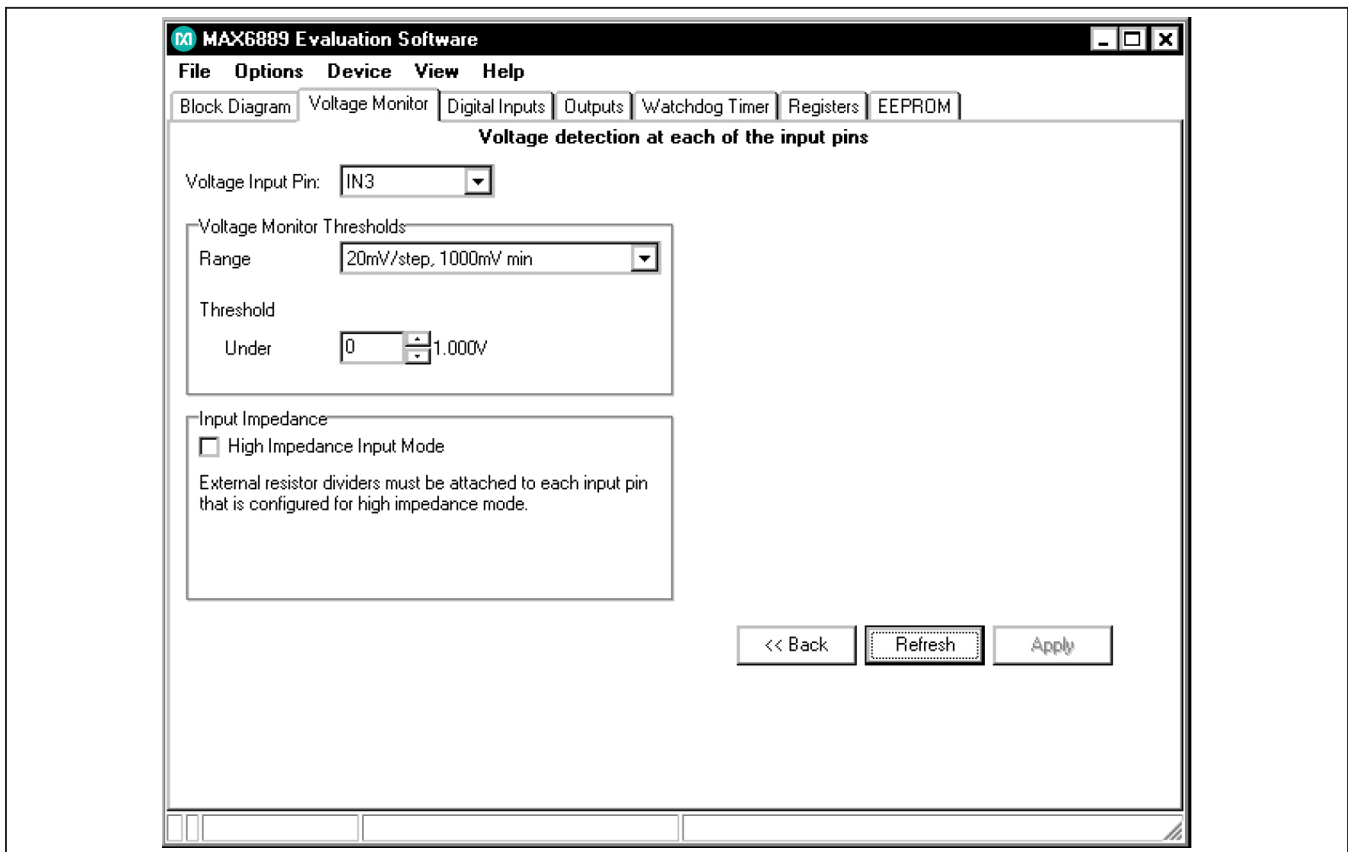

Figure 3. Voltage Monitor Tab

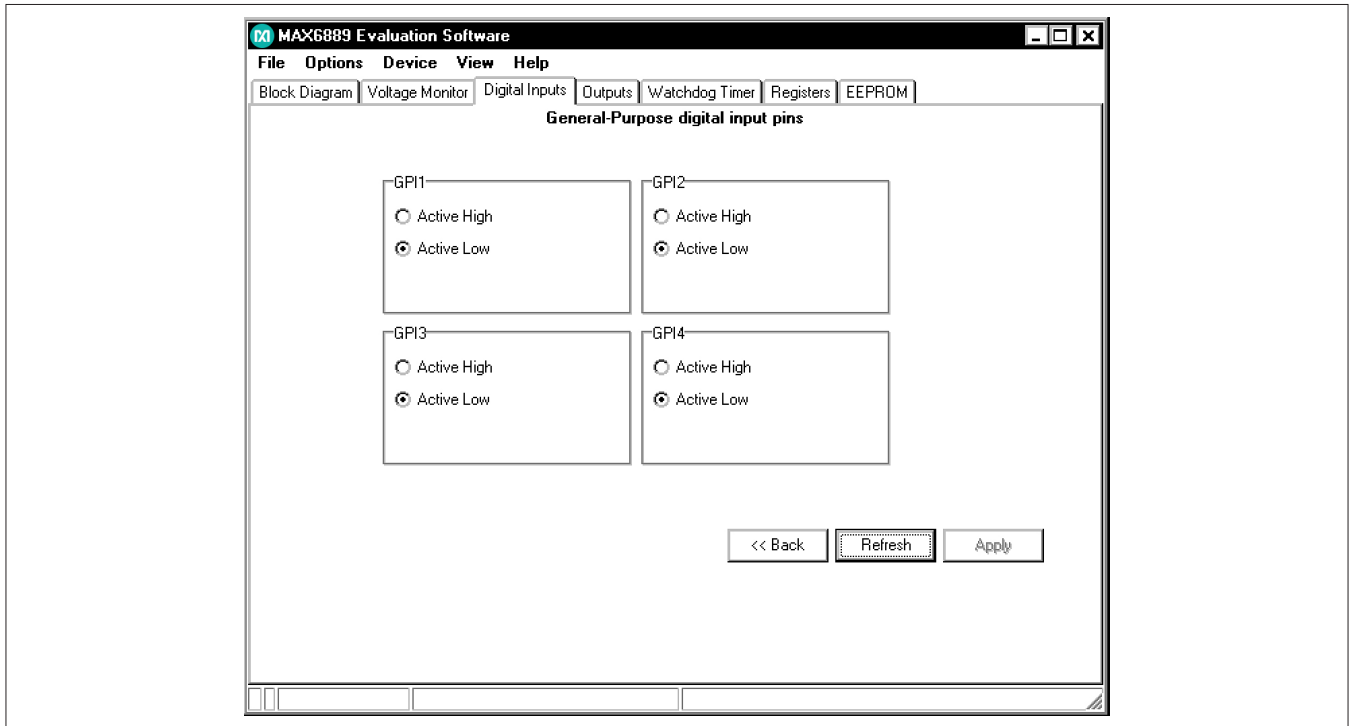

Figure 4. Digital Inputs Tab

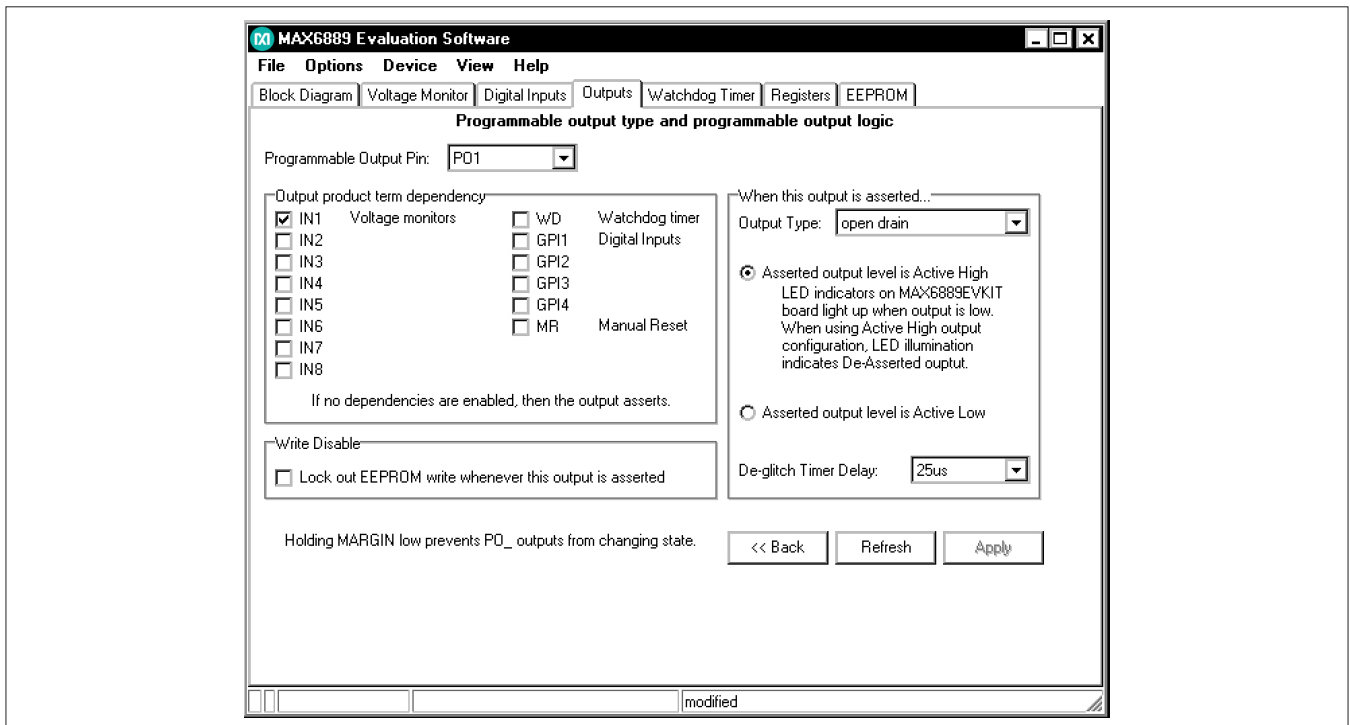

Figure 5. Programmable Outputs Tab

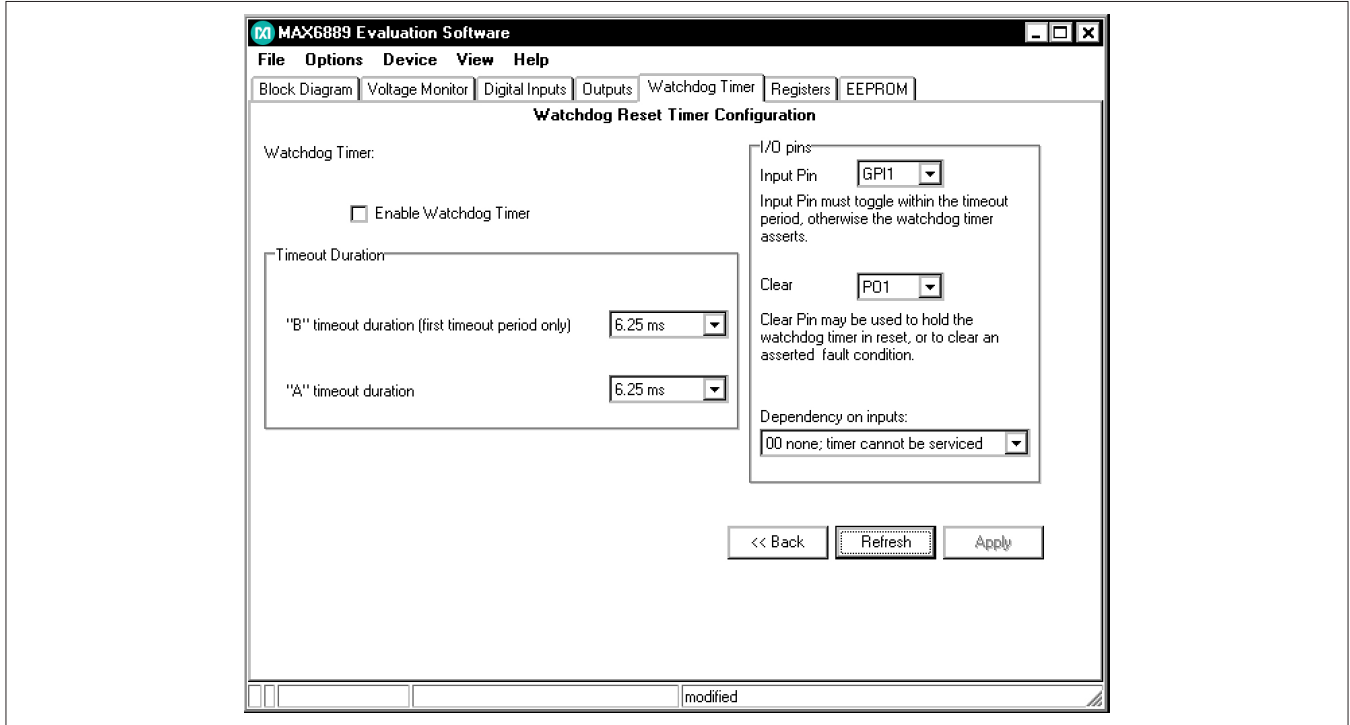

Figure 6. Watchdog Timers Tab

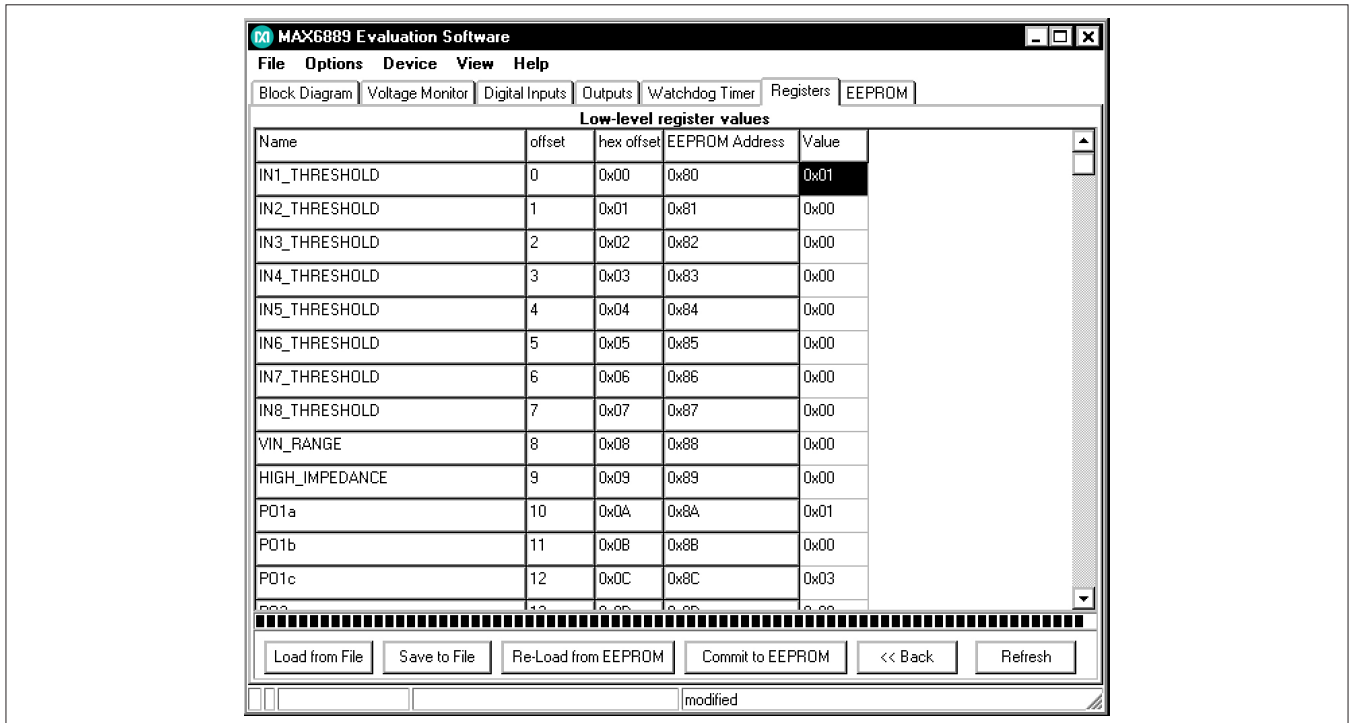

Figure 7. Registers Tab

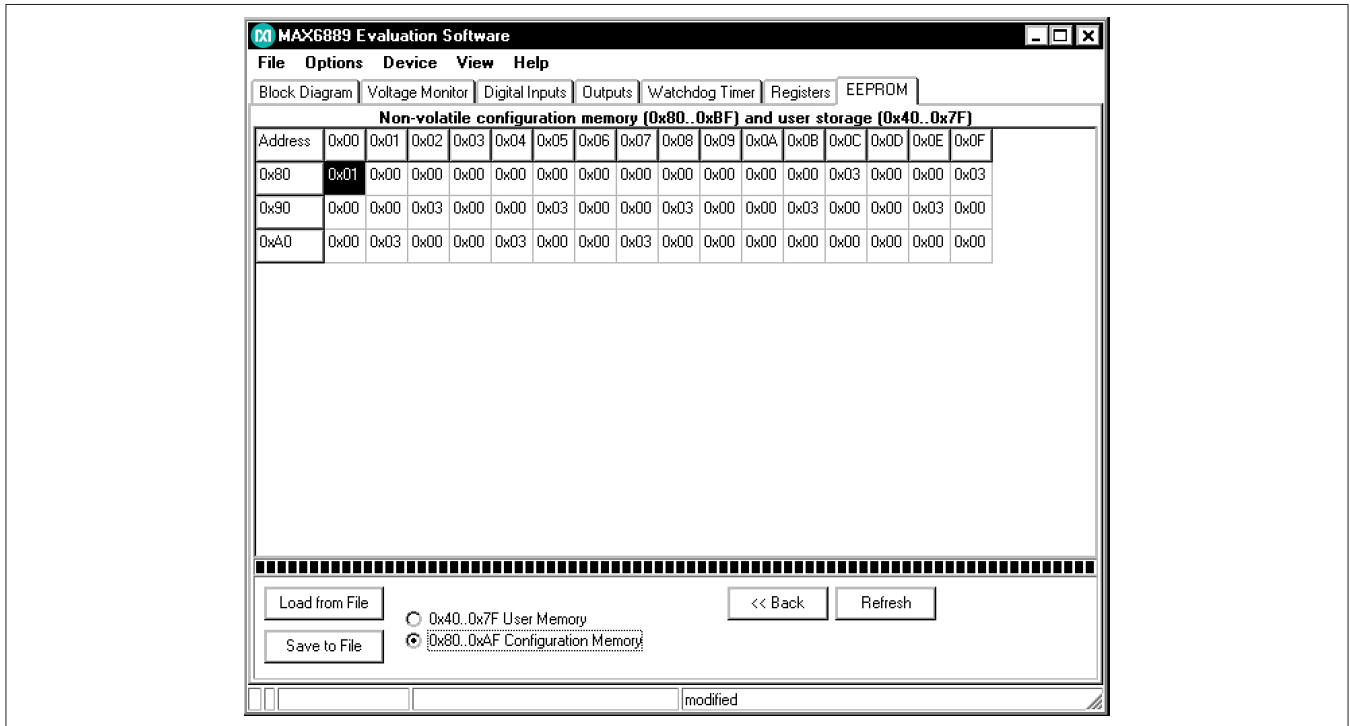

Figure 8. EEPROM Memory Tab

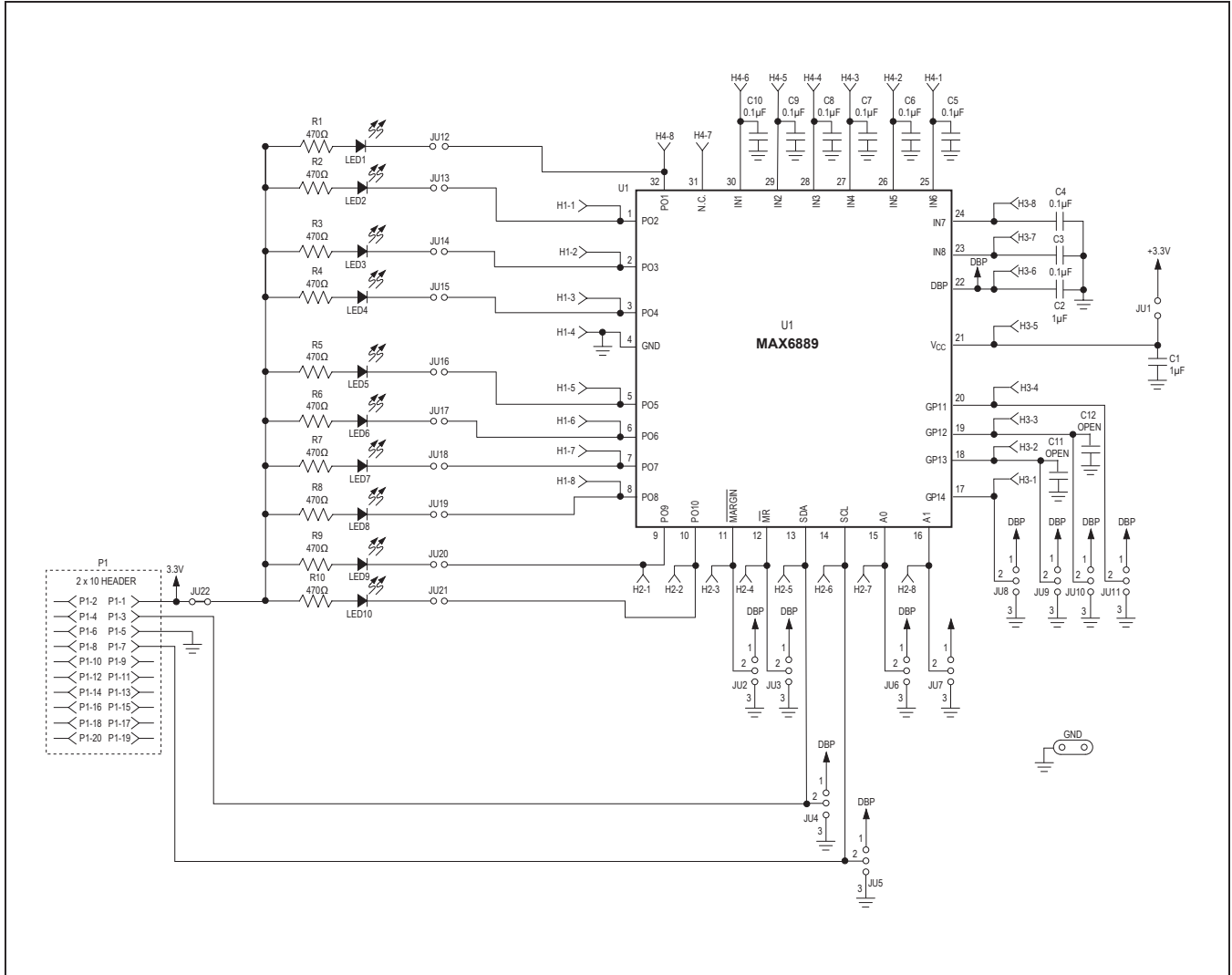

Figure 9. MAX6889 EV Kit Schematic

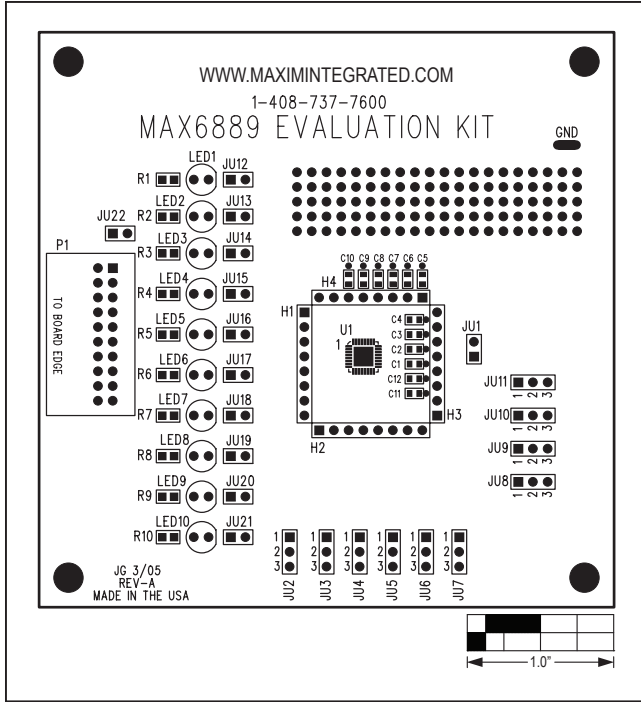

Figure 10. MAX6889 EV Kit Component Placement Guide—Component Side

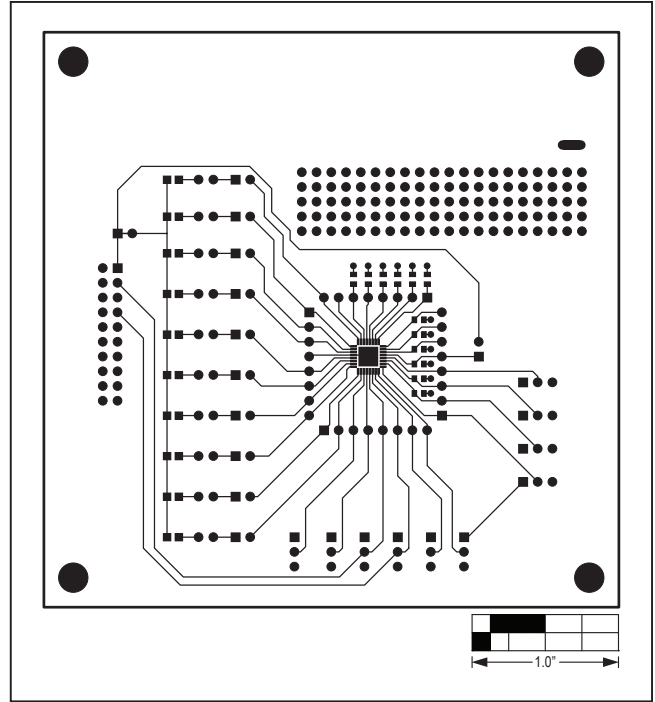

Figure 11. MAX6889 EV Kit PC Board Layout—Component Side

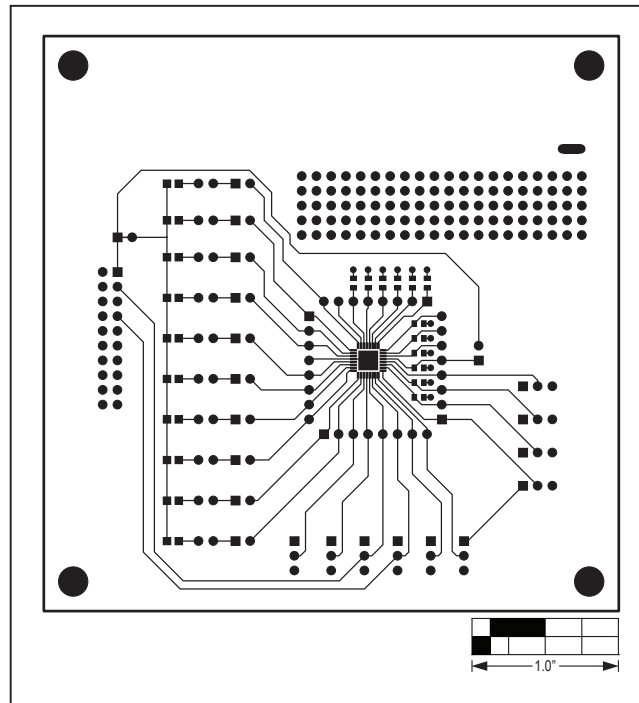

Figure 12. MAX6889 EV Kit PC Board Layout—Solder Side

Revision History

REVISION NUMBER	REVISION DATE	DESCRIPTION	PAGES CHANGED
0	5/05	Initial Release	—
1	8/05	Replace CMOD232 with CMAXQUSB	1,2
2	1/21	Updated <i>Ordering Information</i>	1
3	3/21	Updated <i>Ordering Information</i>	1

For pricing, delivery, and ordering information, please visit Maxim Integrated's online storefront at <https://www.maximintegrated.com/en/storefront/storefront.html>.

Maxim Integrated cannot assume responsibility for use of any circuitry other than circuitry entirely embodied in a Maxim Integrated product. No circuit patent licenses are implied. Maxim Integrated reserves the right to change the circuitry and specifications without notice at any time.