

Click [here](#) to ask about the production status of specific part numbers.

MAX44290

1.8V, 15MHz, Low-Offset, Low-Power, Rail-to-Rail I/O Op Amp

General Description

The MAX44290 offers a unique combination of high-speed, precision, and low-voltage operation, making it ideally suited for a large number of signal-processing functions, such as filtering and amplification of signals in portable and industrial equipment.

This amplifier features an input offset of less than 50 μ V and a high-gain bandwidth product of 15MHz while maintaining a low 1.8V supply rail. The device's rail-to-rail input/outputs and low noise guarantee maximum dynamic range in demanding applications, such as 12- to 14-bit SAR ADC drivers. Unlike traditional rail-to-rail input structures, input crossover distortion is absent due to an optimized input stage with an ultra-quiet charge pump.

The device includes a fast-power-on shutdown mode for further power savings. The operational amplifier operates from a supply range of 1.8V to 5.5V over the -40°C to +125°C temperature range, and can operate down to 1.7V over the 0°C to +70°C temperature range. It is available in a tiny, 6-bump wafer-level package (WLP) with 0.4mm pitch.

Applications

- Notebooks
- 3G/4G Handsets
- Portable Medical Instruments
- Battery-Operated Devices
- Analog-to-Digital Converter Buffers
- Transimpedance Amplifiers
- General-Purpose Signal Processing

Benefits and Features

- Low 1.8V Supply Rail over the -40°C to +125°C Range
- 1.7V Supply Rail over 0°C to +70°C Range
- 15MHz Unity-Gain Bandwidth
- Low 12.7nV/ $\sqrt{\text{Hz}}$ Input Voltage-Noise Density
- Low 50 μ V (max) Input Offset Voltage at +25°C
- 500fA Low Input Bias Current
- 750 μ A Quiescent Current
- <1 μ A Supply Current in Shutdown
- Low 105dB Total Harmonic Distortion

Ordering Information appears at end of data sheet.

Pin Configuration

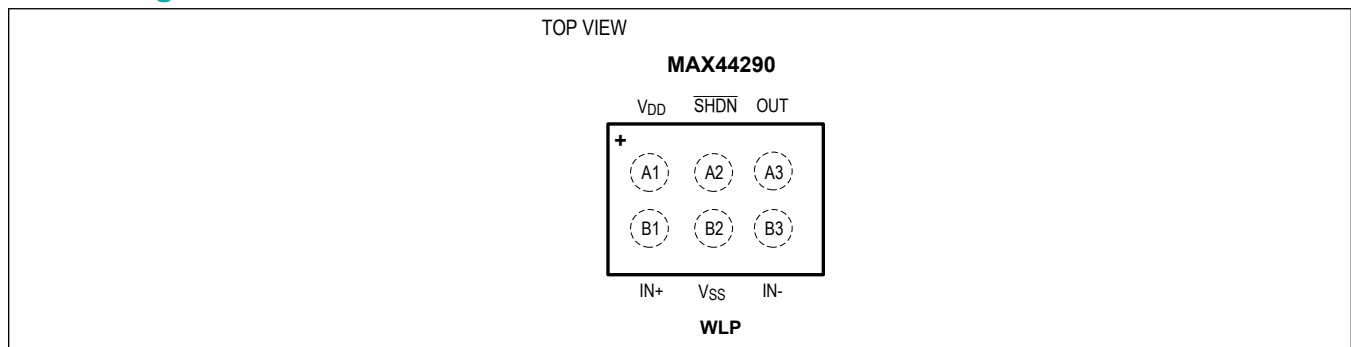

TABLE OF CONTENTS

General Description	1
Applications	1
Benefits and Features	1
Pin Configuration	1
Absolute Maximum Ratings	4
Package Information	4
6 WLP	4
Electrical Characteristics	5
Typical Operating Characteristics	8
Pin Configuration	11
Pin Description	11
Detailed Description	13
Crossover Distortion	13
Applications Information	15
Power-Up Autotrim	15
Shutdown Operation	15
Rail-to-Rail Input/Output	15
Input Bias Current	15
Driver for Interfacing with the MAX11645 ADC	16
High-Impedance Source/Sensor Preamp Application	16
Typical Application Circuits	16
Sallen-Key Filter	16
Howland Current Pump	17
Ordering Information	17
Revision History	18

LIST OF FIGURES

Figure 1. Comparing the Input Structure of the MAX44290 to Standard Op Amps. 13
Figure 2. Crossover Distortion of Typical Amplifiers 14
Figure 3. Shutdown Input Operation 15

Absolute Maximum Ratings

Supply Voltage (V _{DD} to V _{SS})	-0.3V to +6V	Continuous Power Dissipation (T _A = +70°C)	
SHDN	-0.3V to +6V	(derate 10.5mW/°C above +70°C)	840mW
IN+, IN- Maximum Voltage	Self Limiting*	Junction-to-Ambient Thermal Resistance (θ _{JA})	95.15°C/W
OUT	(V _{SS} - 0.3V) to (V _{DD} + 0.3V)	Junction-to-Case Thermal Resistance (θ _{JC})	70°C/W
Output Short-Circuit Duration to V _{DD} or V _{SS}	Continuous	Operating Temperature Range	-40°C to +125°C
Continuous Input Current (any pins)	±20mA	Junction Temperature	+150°C
Differential Input Voltage	±6V	Storage Temperature Range	-65°C to +150°C
* Note	Not to exceed +6V	Lead Temperature (soldering, 10s).....	+300°C

Note 1: Package thermal resistances were obtained using the method described in JEDEC specification JESD51-7, using a four-layer board. For detailed information on package thermal considerations, refer to www.maximintegrated.com/thermal-tutorial.

Stresses beyond those listed under "Absolute Maximum Ratings" may cause permanent damage to the device. These are stress ratings only, and functional operation of the device at these or any other conditions beyond those indicated in the operational sections of the specifications is not implied. Exposure to absolute maximum rating conditions for extended periods may affect device reliability.

Package Information

6 WLP

Package Code	N60C1+1
Outline Number	21-100055
Land Pattern Number	Refer to Application Note 1891

For the latest package outline information and land patterns (footprints), go to www.maximintegrated.com/packages. Note that a "+", "#", or "-" in the package code indicates RoHS status only. Package drawings may show a different suffix character, but the drawing pertains to the package regardless of RoHS status.

Package thermal resistances were obtained using the method described in JEDEC specification JESD51-7, using a four-layer board. For detailed information on package thermal considerations, refer to www.maximintegrated.com/thermal-tutorial.

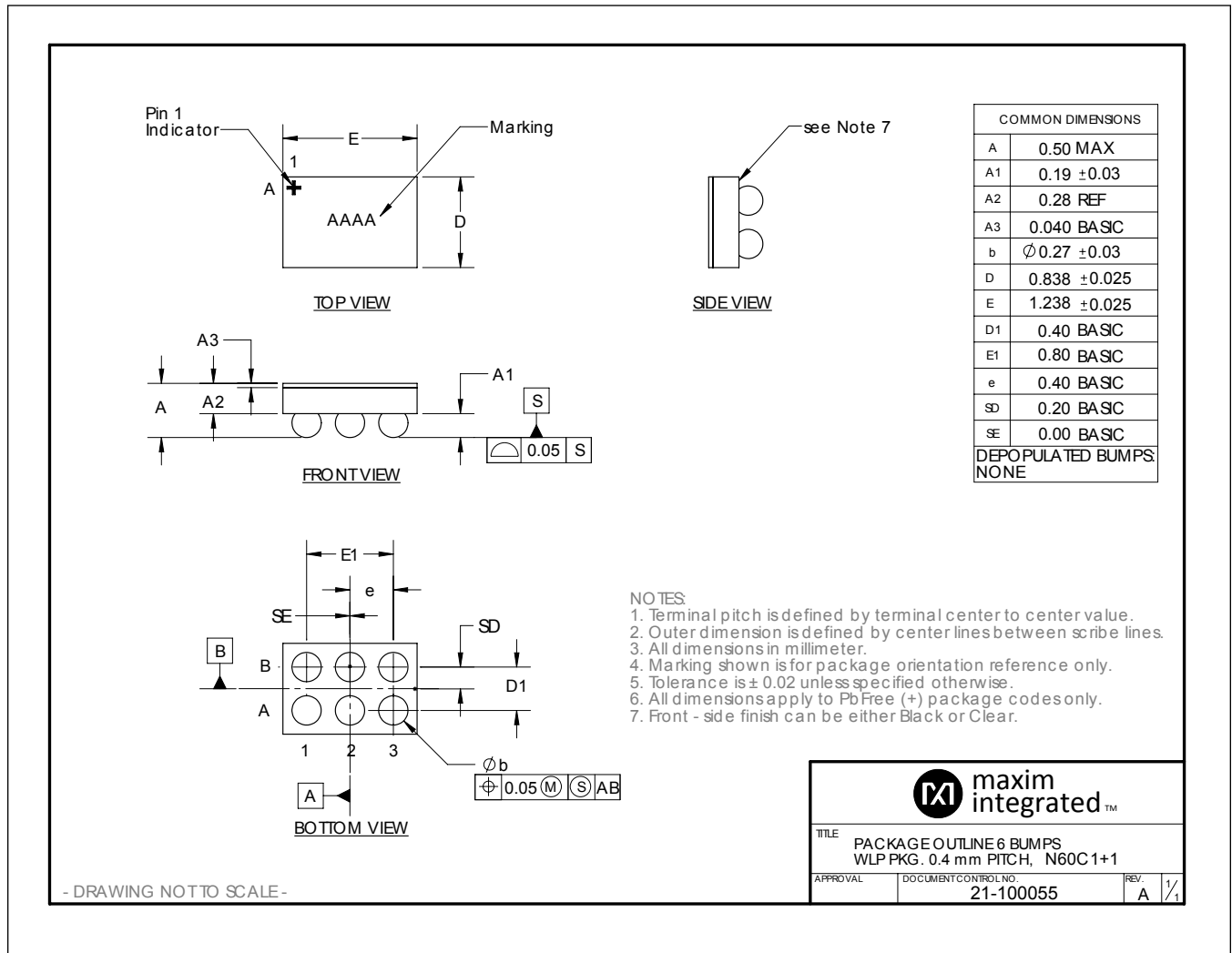

Electrical Characteristics

($V_{DD} = 3.3V$, $V_{SS} = 0V$, $V_{IN+} = V_{IN-} = V_{DD}/2$, $R_{LOAD} = 10k\Omega$ to $V_{DD}/2$, $V_{SHDN} = V_{DD}$, $T_A = -40^{\circ}C$ to $+125^{\circ}C$, unless otherwise noted. Typical values are at $+25^{\circ}C$.) (Note 2)

PARAMETER	SYMBOL	CONDITIONS	MIN	TYP	MAX	UNITS
POWER SUPPLY						
Supply Voltage Range	V_{DD}	Guaranteed by PSRR	1.8		5.5	V
		Over $0^{\circ}C < T_A < +70^{\circ}C$	1.7		5.5	
Power-Supply Rejection Ratio	PSRR	$V_{CM} = V_{DD}/2$	82	95		dB
Quiescent Current	I_{DD}	$R_{LOAD} = \text{no load}$		750	1200	μA
Shutdown Supply Current	I_{SHDN}				1	μA
Shutdown Input Low	V_{IL}				0.5	V

Electrical Characteristics (continued)

($V_{DD} = 3.3V$, $V_{SS} = 0V$, $V_{IN+} = V_{IN-} = V_{DD}/2$, $R_{LOAD} = 10k\Omega$ to $V_{DD}/2$, $V_{SHDN} = V_{DD}$, $T_A = -40^{\circ}C$ to $+125^{\circ}C$, unless otherwise noted. Typical values are at $+25^{\circ}C$.) (Note 2)

PARAMETER	SYMBOL	CONDITIONS	MIN	TYP	MAX	UNITS
Shutdown Input High	V_{IH}		1.3			V
Output Leakage Current in Shutdown				100		pA
Shutdown Input Bias Current	I_{IL}/I_{IH}				1	μA
Shutdown Turn-On Time	t_{SHDN}	$T_A = +25^{\circ}C$ (Note 3)		14.4	18.9	μs
		$-40^{\circ}C < T_A < +125^{\circ}C$ (Note 3)			26.7	
Power-Up Time	t_{ON}	$T_A = +25^{\circ}C$ (Note 3)		9.7	15.2	ms
		$-40^{\circ}C < T_A < +125^{\circ}C$ (Note 3)			18.4	
DC CHARACTERISTICS						
Input Common-Mode Range	V_{CM}	Guaranteed by CMRR test	$V_{SS} - 0.1$		$V_{DD} + 0.1$	V
Common-Mode Rejection Ratio	CMRR	$V_{CM} = V_{SS} - 0.1V$ to $V_{DD} + 0.1V$	75	90		dB
Input Offset Voltage (Note 3)	V_{OS}	$T_A = +25^{\circ}C$ (Note 4)		10	50	μV
		$-40^{\circ}C \leq T_A \leq +125^{\circ}C$ (Note 5)			100	
		$-40^{\circ}C \leq T_A \leq +125^{\circ}C$ (Note 6)			500	
Input Offset Voltage Drift (Note 3)	TC V_{OS}			0.8	5	$\mu V/^{\circ}C$
Input Bias Current (Note 3)	I_B	$T_A = +25^{\circ}C$		0.01	0.5	pA
		$-40^{\circ}C < T_A < +85^{\circ}C$			10	
		$-40^{\circ}C < T_A < +125^{\circ}C$			100	
Open-Loop Gain	A_{VOL}	$400mV \leq V_{OUT} \leq V_{DD} - 400mV$, $R_{LOAD} = 10k\Omega$	100	115		dB
		$400mV \leq V_{OUT} \leq V_{DD} - 400mV$, $R_{LOAD} = 600\Omega$	91	100		
		$400mV \leq V_{OUT} \leq V_{DD} - 400mV$, $R_{LOAD} = 32\Omega$		80		
Output Short-Circuit Current		To V_{DD} or V_{SS}		50		mA
Output Voltage Low	V_{OL}	$V_{OUT} - V_{SS}$	$R_{LOAD} = 10k\Omega$ to $V_{DD}/2$		20	mV
			$R_{LOAD} = 600\Omega$ to $V_{DD}/2$		50	
			$R_{LOAD} = 32\Omega$ to $V_{DD}/2$	400	700	

Electrical Characteristics (continued)

($V_{DD} = 3.3V$, $V_{SS} = 0V$, $V_{IN+} = V_{IN-} = V_{DD}/2$, $R_{LOAD} = 10k\Omega$ to $V_{DD}/2$, $\overline{V_{SHDN}} = V_{DD}$, $T_A = -40^{\circ}C$ to $+125^{\circ}C$, unless otherwise noted. Typical values are at $+25^{\circ}C$.) (Note 2)

PARAMETER	SYMBOL	CONDITIONS		MIN	TYP	MAX	UNITS
Output Voltage High	V_{OH}	$V_{DD} - V_{OUT}$	$R_{LOAD} = 10k\Omega$ to $V_{DD}/2$			10	mV
			$R_{LOAD} = 600\Omega$ to $V_{DD}/2$			40	
			$R_{LOAD} = 32\Omega$ to $V_{DD}/2$		400	800	
AC CHARACTERISTICS							
Input Voltage Noise Density	e_n	$f = 10kHz$			12.7		nV/\sqrt{Hz}
Input Voltage Noise		$0.1Hz \leq f \leq 10Hz$			10		μV_{P-P}
Input Capacitance	C_{IN}				2.5		pF
Gain-Bandwidth Product	GBW				15		MHz
Slew Rate	SR	$A_V = 1V/V$, $V_{OUT} = 2V_{P-P}$, 10% to 90%			7		$V/\mu s$
Capacitive Loading	C_{LOAD}	No sustained oscillation, $A_V = 1V/V$			300		pF
Total Harmonic Distortion + Noise	THD+N	$V_{OUT} = 2V_{P-P}$, $A_V = 1V/V$, $R_{LOAD} = 10k\Omega$	$f = 10kHz$		-105		dB
Settling Time		To 0.01%, $V_{OUT} = 2V_{P-P}$, $A_V = 1V/V$, $C_{LOAD} = 30pF$			1.7		μs
Output Transient Recovery Time		$\Delta V_{OUT} = 0.2V$, $V_{DD} = 3.3V$, $A_V = 1V/V$, $R_S = 20\Omega$, $C_{LOAD} = 1nF$			1		μs

Note 2: All devices are 100% production tested at $T_A = +25^{\circ}C$. Specifications over temperature are guaranteed by design.

Note 3: Guaranteed by design.

Note 4: At $+25^{\circ}C$, upon power up and after calibration.

Note 5: For any temperature values between $-40^{\circ}C$ to $+125^{\circ}C$, upon power up and after calibration.

Note 6: For any temperature values between $-40^{\circ}C$ and $+125^{\circ}C$ it indicates the maximum drift from power up, initial calibrated value.

Typical Operating Characteristics

($T_A = +25^\circ\text{C}$, unless otherwise noted.)

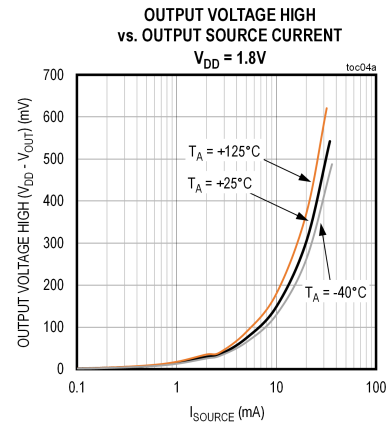
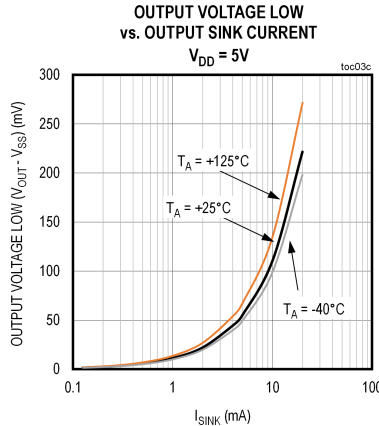
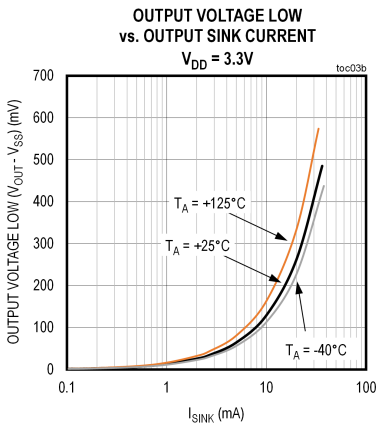
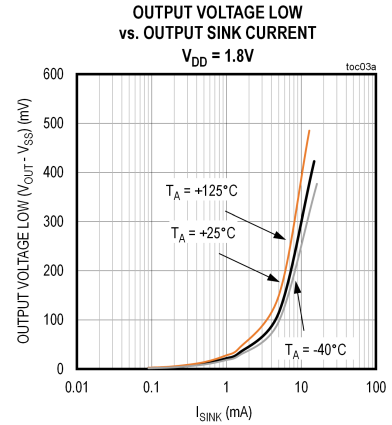
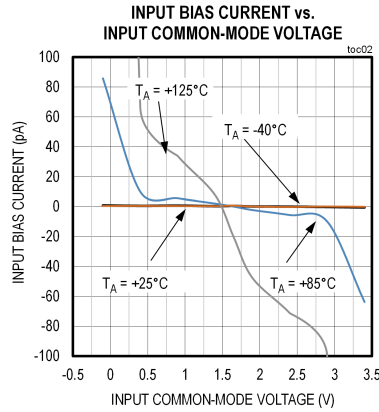
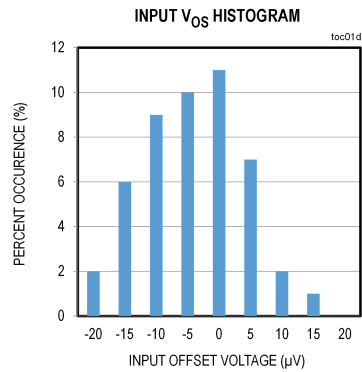
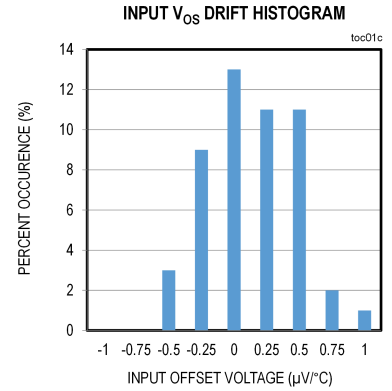
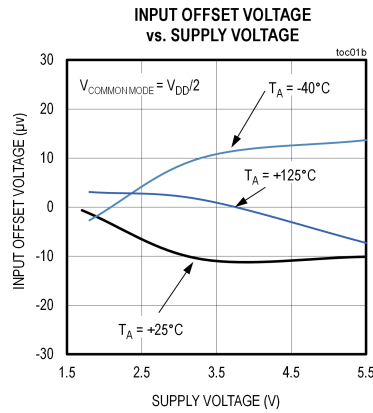
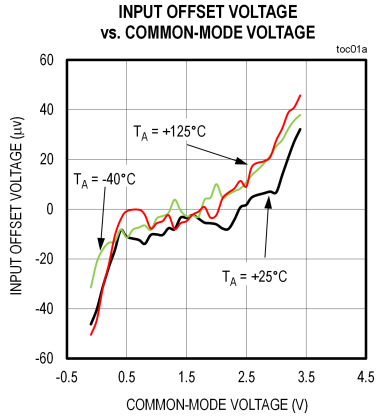

Typical Operating Characteristics (continued)

($T_A = +25^\circ\text{C}$, unless otherwise noted.)

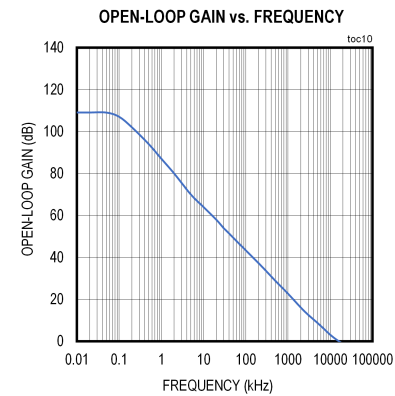
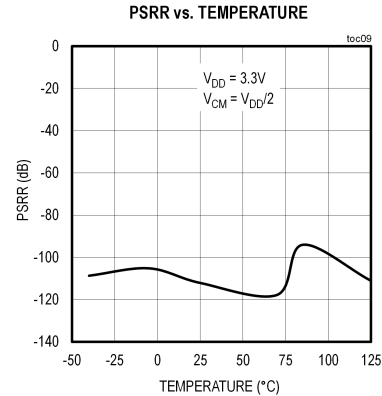
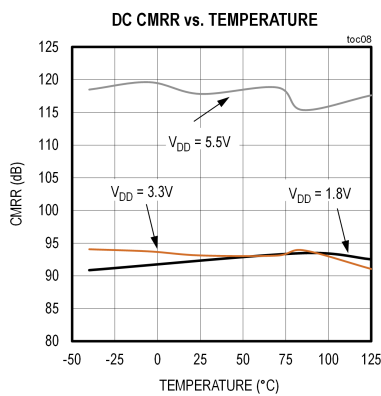
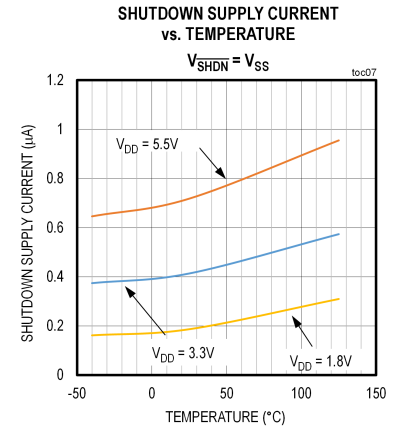
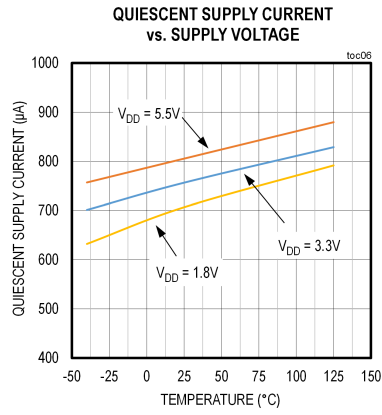
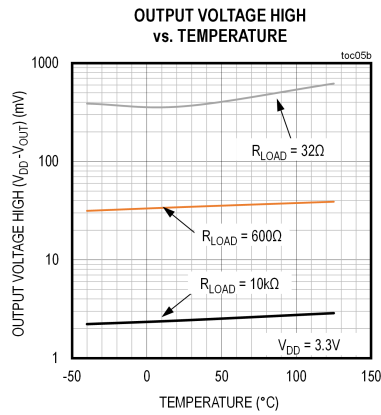
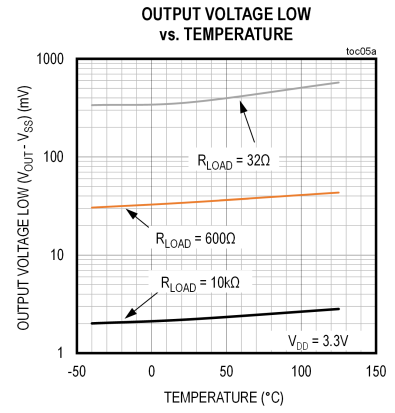
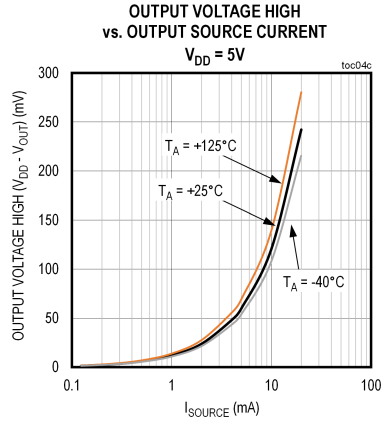
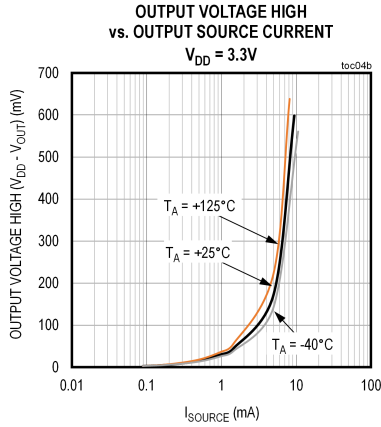

Typical Operating Characteristics (continued)

($T_A = +25^\circ\text{C}$, unless otherwise noted.)

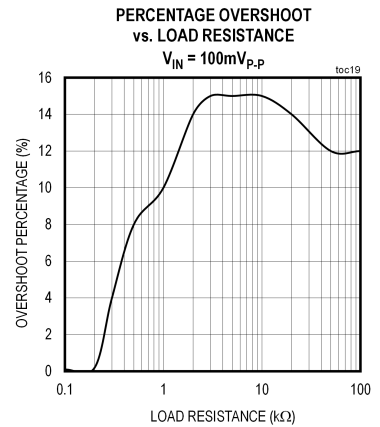
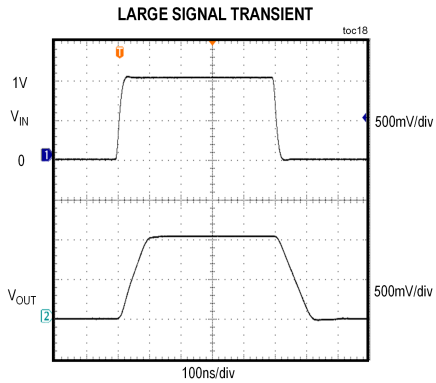
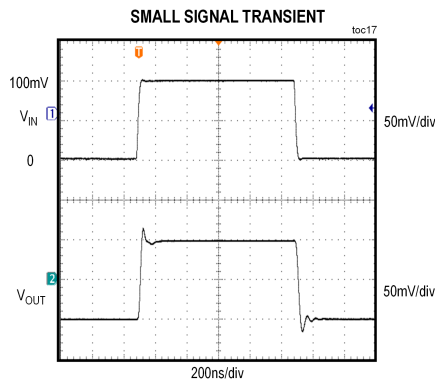
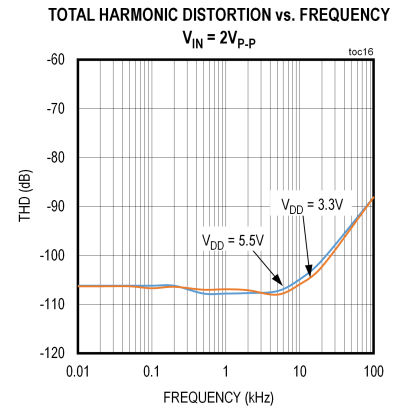
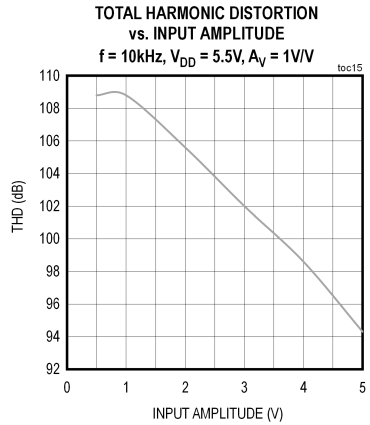
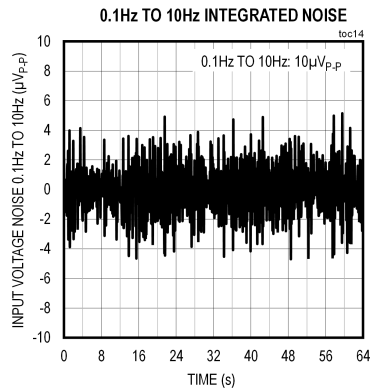
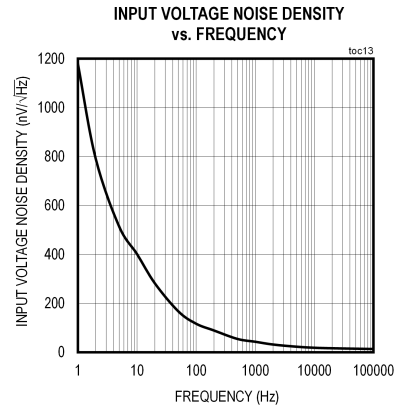
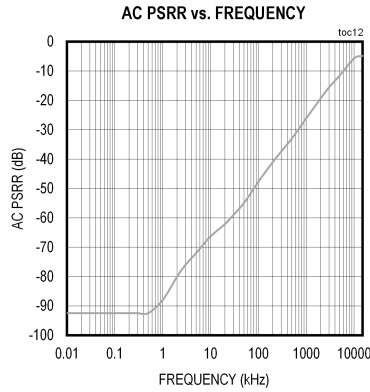
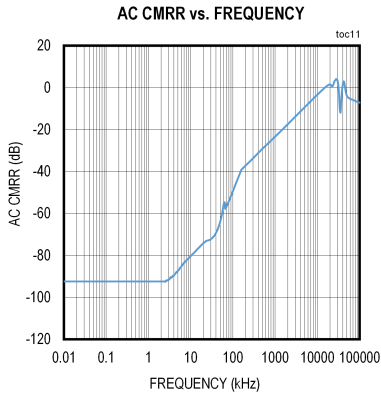

Typical Operating Characteristics (continued)

(T_A = +25°C, unless otherwise noted.)

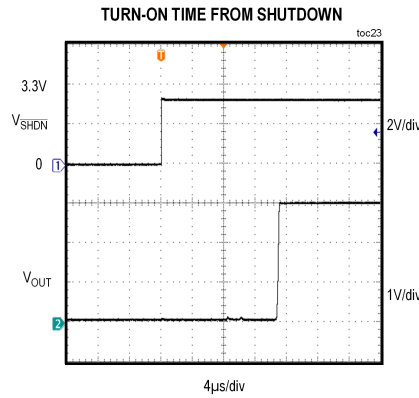
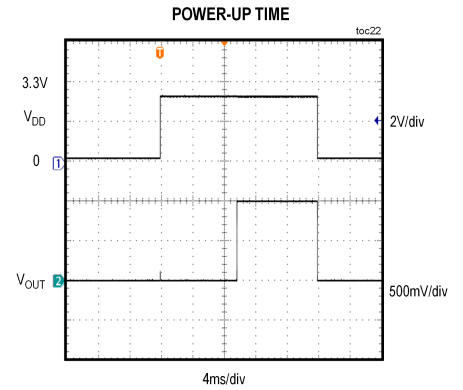
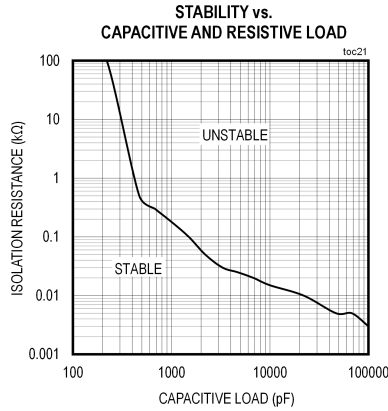
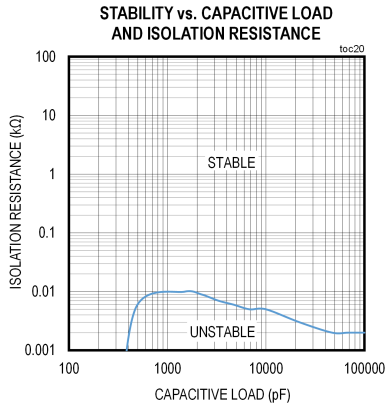

Pin Configuration

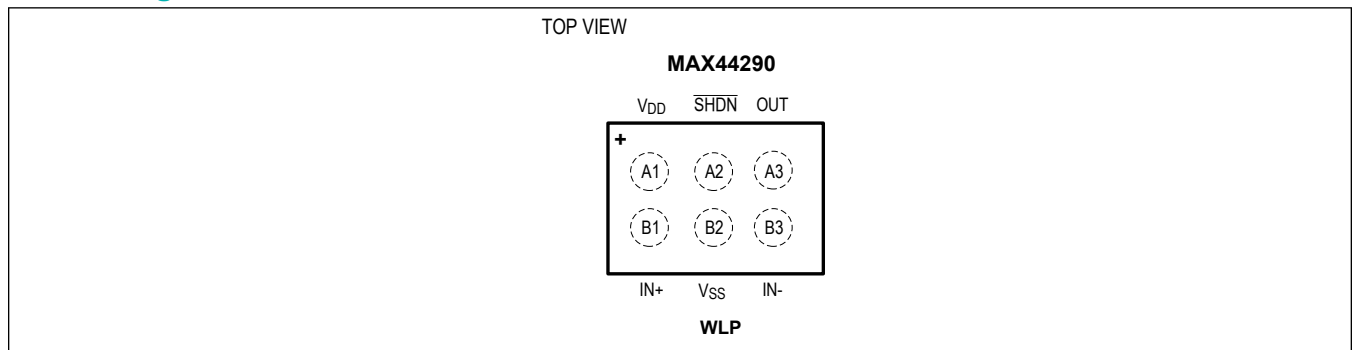

Pin Description

PIN	NAME	FUNCTION	TYPE
A1	V _{DD}	Positive Supply Voltage	Power

Pin Description (continued)

PIN	NAME	FUNCTION	TYPE
A2	$\overline{\text{SHDN}}$	Active-Low Shutdown Input. Connect to V_{DD} for normal operation.	Analog Input
A3	OUTA	Output	Analog Output
B1	IN+	Positive Input	Analog Input
B2	V_{SS}	Negative Supply Voltage. Connect to the ground return of the V_{DD} supply.	Power
B3	IN-	Negative Input	Analog Input

Detailed Description

The MAX44290 is a high-speed, low-power operational amplifier (op amp) ideal for signal-processing applications due to the device's high-precision and low-noise CMOS inputs. The device self-calibrates on power-up to eliminate the effects of temperature and power-supply variation.

The device also features a low-power shutdown mode that greatly reduces quiescent current while the device is not operational and recovers in less than 30 μ s. The device features autocalibration at a power-up event. The calibration routine takes less than 20ms.

Crossover Distortion

The device features a low-noise integrated charge pump that creates an internal voltage rail 1V above V_{DD} , which powers the input differential pair of PMOS transistors, as shown in [Figure 1](#). Such a unique architecture eliminates crossover distortion common in traditional CMOS input architecture ([Figure 2](#)), especially when used in a noninverting configuration, such as for Sallen-Key filters.

The charge pump operating frequency lies well above the unity-gain frequency of the amplifier. Because of its high-frequency operation and ultra-quiet circuitry, the charge pump generates little noise, does not require external components, and is entirely transparent to the user.

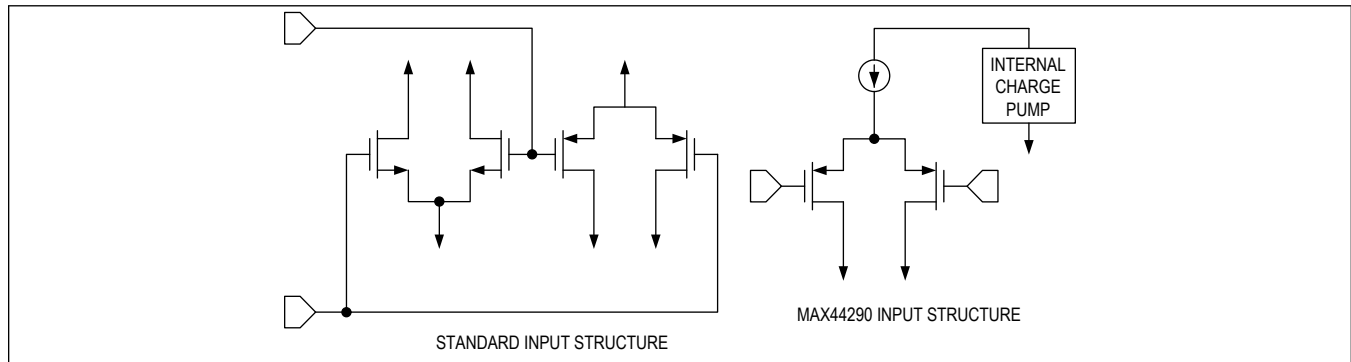

Figure 1. Comparing the Input Structure of the MAX44290 to Standard Op Amps

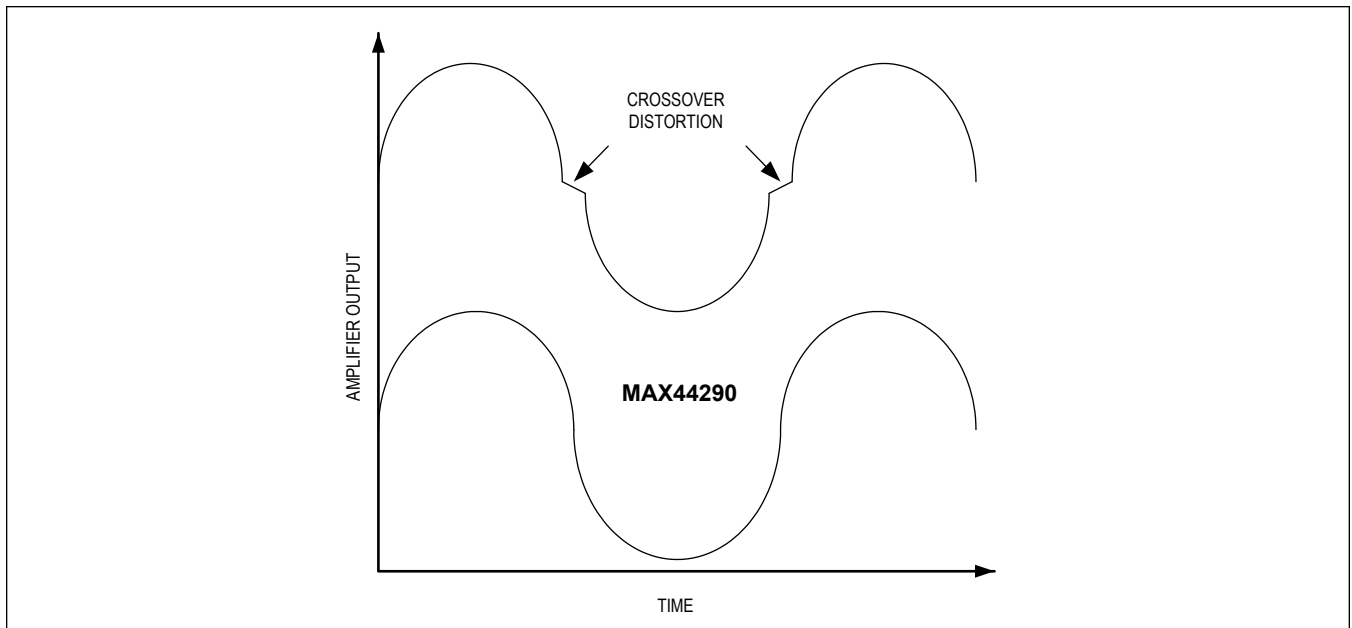

Figure 2. Crossover Distortion of Typical Amplifiers

Applications Information

Power-Up Autotrim

The device features an automatic trim that self-calibrates the input offset voltage (V_{OS}) to less than $50\mu\text{V}$ of input offset voltage on power-up. This self-calibration feature allows the device to eliminate input offset voltage effects due to power supply and operating temperature variation simply by cycling its power. The autotrim sequence takes less than 20ms to complete and is triggered by an internal power-on-reset (POR) circuitry. During this time, the inputs and outputs are at high impedance and left unconnected.

Shutdown Operation

The MAX44290 features an active-low shutdown mode that puts both inputs and outputs into high impedance and substantially lowers the quiescent current to less than $1\mu\text{A}$. Putting the output into high impedance allows multiple outputs to be multiplexed onto a single output line without the additional external buffers. The device does not self-calibrate when exiting shutdown mode and retains its power-up trim settings. [Figure 3](#) shows how the device recovers from shutdown in less than $30\mu\text{s}$.

The shutdown logic levels of the device are independent of supply, allowing the shutdown feature of the device to operate off a 1.8V or 3.3V microcontroller, regardless of supply voltage.

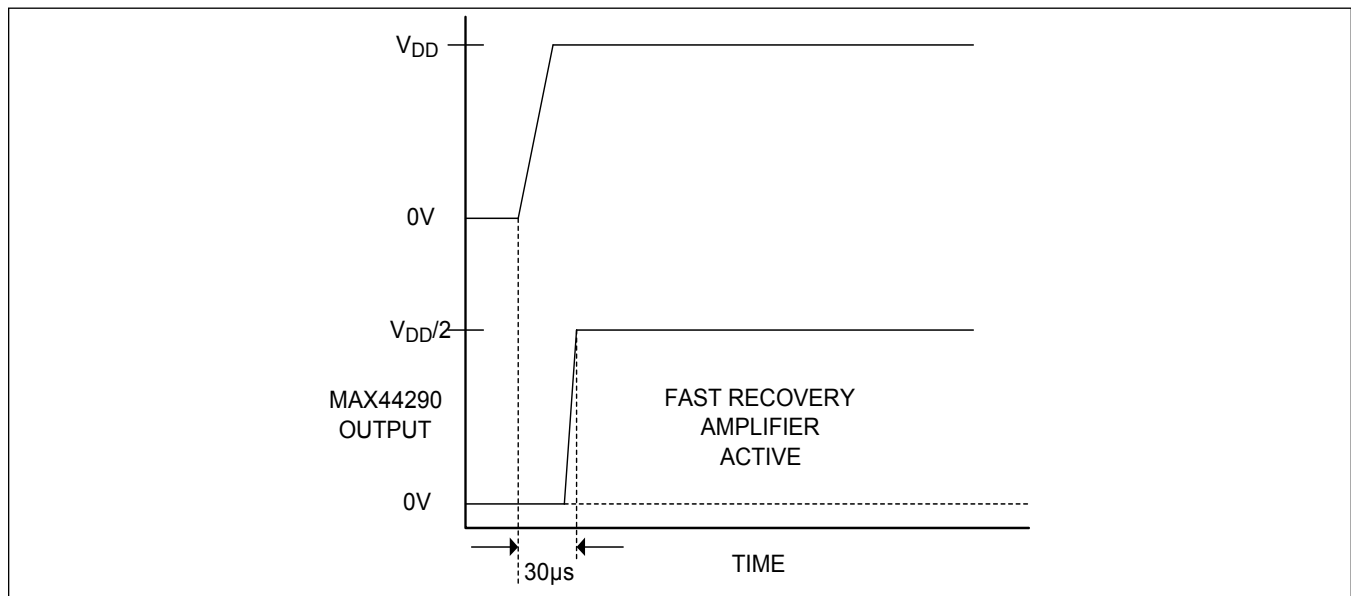

Figure 3. Shutdown Input Operation

Rail-to-Rail Input/Output

The input voltage range of the device extends 100mV above V_{DD} and below V_{SS} . The wide input common mode voltage range allows the op amp to be used as a buffer and as a differential amplifier in a variety of signal processing applications. Output voltage high/low is only 50mV above V_{SS} and below V_{DD} , allowing maximum dynamic range in single-supply applications. The high output current and capacitance drive capability of the device make it ideal as an ADC driver and a line driver.

Input Bias Current

The MAX44290 features a high-impedance CMOS input stage and a specialized ESD structure that allows low input bias current operation at low-input, common-mode voltages. Low-input bias current is useful when interfacing with high-

impedance sensors. It is also beneficial for designing transimpedance amplifiers for photodiode sensors. This makes the device ideal for ground referenced medical and industrial sensor applications.

Driver for Interfacing with the MAX11645 ADC

The device's tiny size and low noise makes it a good fit for driving 12- to 16-bit resolution ADCs in space-constrained applications. The [Typical Application Circuits](#) show the MAX44290 amplifier output connected to a lowpass filter driving the MAX11645 ADC. The MAX11645 is part of a family of 3V and 5V, 12-bit and 10-bit, 2-channel ADCs.

The MAX11645 offers sample rates up to 94ksps and measures two single-ended inputs or one differential input. These ADCs dissipate 670µA at the maximum sampling rate, but just 6µA at 1ksps and 0.5µA in shutdown. Offered in ultra-tiny, 1.9mm x 2.2mm WLP and 8-pin µMAX packages, the MAX11645 ADCs are an ideal fit to pair with the MAX44290 in portable applications where higher resolution is required. Refer to the MAX1069 (14-bit) and MAX1169 (16-bit) ADC families.

$$I_{LOAD} = \frac{V_{IN}}{(R3 + R4)} \times \left(1 + \left(\frac{2 \times R4}{R5}\right)\right)$$

AND

$$\frac{R2}{R1} = \frac{R4 + R5}{R3}$$

High-Impedance Source/Sensor Preamp Application

High-impedance sources, such as pH sensors and photodiodes, in applications require negligible input leakage currents to the input transimpedance/buffer structure. The MAX44290 benefits with clean and precise signal conditioning due to its input structure.

The device interfaces to both current-output sensors (photodiodes), and high-impedance voltage sources (piezoelectric sensors). For current output sensors, a transimpedance amplifier is the most noise-efficient method for converting the input signal to a voltage. High-value feedback resistors are commonly chosen to create large gains, while feedback capacitors help stabilize the amplifier by cancelling any poles introduced in the feedback loop by the highly capacitive sensor or cabling. A combination of low-current noise and low-voltage noise is important for these applications. Care must be taken to calibrate out photodiode dark current if DC accuracy is important. The high bandwidth and slew rate also allow AC signal processing in certain medical photodiode sensor applications such as pulse-oximetry. For voltage-output sensors, a noninverting amplifier is typically used to buffer and/or apply a small gain to the input voltage signal. Due to the extremely high impedance of the sensor output, a low input bias current with minimal temperature variation is very important for these applications.

Typical Application Circuits

Sallen-Key Filter

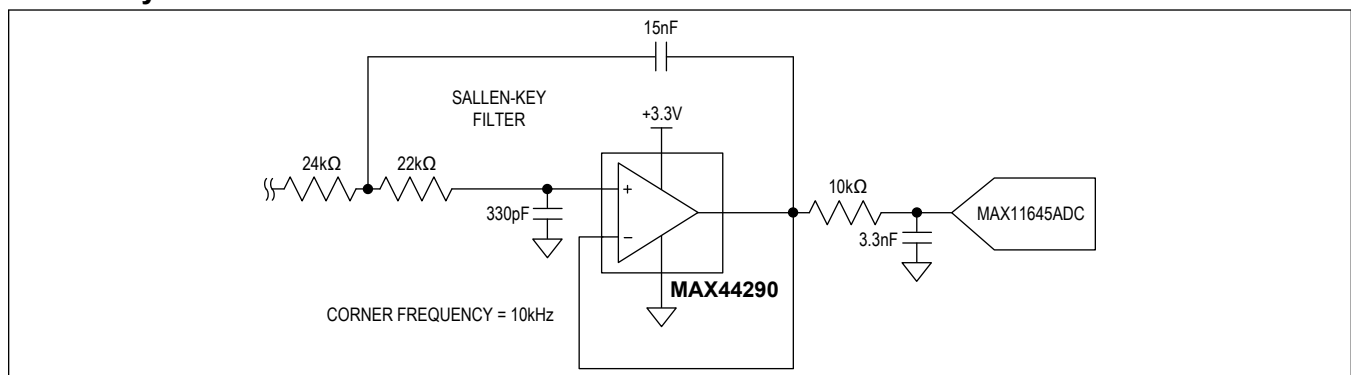

Typical Application Circuits (continued)

Howland Current Pump

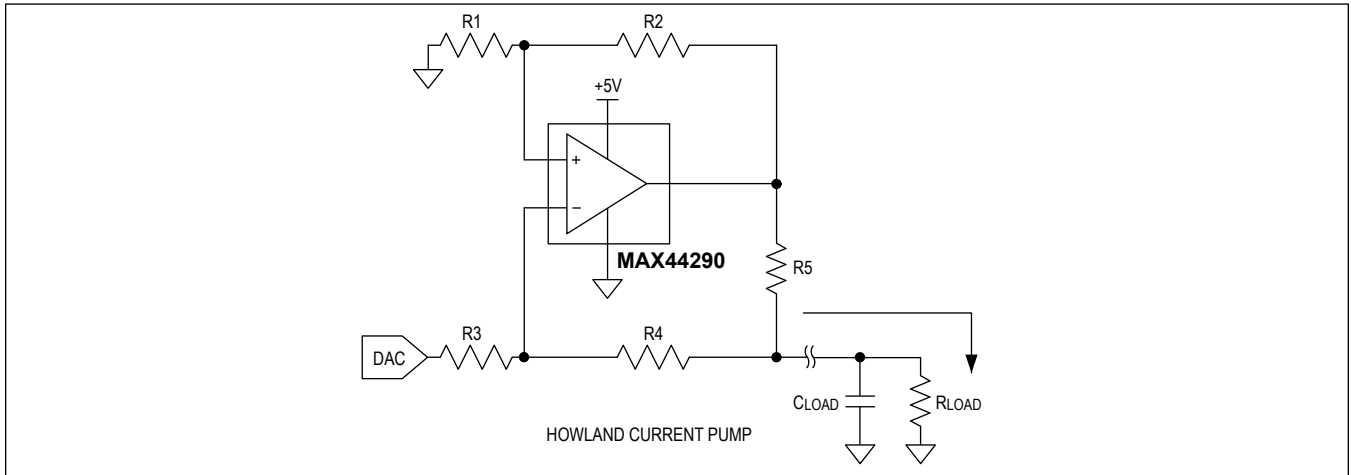

Ordering Information

PART NUMBER	TEMP RANGE	PIN-PACKAGE	PACKAGE COMMENTS
MAX44290ANT+	-40°C to +125°C	6 WLP	0.4mm pitch, 0.5mm (max) height

+Denotes a lead(Pb)-free/RoHS-compliant package.

Revision History

REVISION NUMBER	REVISION DATE	DESCRIPTION	PAGES CHANGED
0	12/15	Initial release	—
1	3/20	Added package outline drawing	13
2	5/20	Updated <i>Electrical Characteristics</i> table	2
3	6/20	Updated Absolute Max Ratings section, and typos in <i>Electrical Characteristics</i> table	2-4
4	2/21	Updates <i>Electrical Characteristics</i> table, resized TOCs, updated <i>Detailed Description</i> , and <i>Applications Information</i>	6-8, 13-15

For pricing, delivery, and ordering information, please visit Maxim Integrated's online storefront at <https://www.maximintegrated.com/en/storefront/storefront.html>.

Maxim Integrated cannot assume responsibility for use of any circuitry other than circuitry entirely embodied in a Maxim Integrated product. No circuit patent licenses are implied. Maxim Integrated reserves the right to change the circuitry and specifications without notice at any time. The parametric values (min and max limits) shown in the Electrical Characteristics table are guaranteed. Other parametric values quoted in this data sheet are provided for guidance.