

Microsemi
MAX3622 Evaluation Kit

General Description

The MAX3622 evaluation kit (EV kit) is an assembled demonstration board that provides convenient evaluation of the MAX3622 low-jitter, precision clock generator. The EV kit includes a 25MHz crystal on-board to allow immediate testing.

The kit includes switches to allow easy control of the enable/disable functions. The clock outputs use SMA connectors and are AC-coupled to simplify connection to test equipment.

Ordering Information

PART	TYPE
MAX3622EVKIT	EV Kit

Features

- ◆ AC-Coupled I/Os for Ease of Testing
- ◆ Fully Assembled and Tested
- ◆ +3.3V Power-Supply Operation
- ◆ 25MHz Crystal Included On-Board

Component Suppliers

SUPPLIER	WEBSITE
NDK	www.ndk.com

Component List

DESIGNATION	QTY	DESCRIPTION
C1, C3, C4, C5, C11, C13, C14, C18, C19	9	0.1 μ F \pm 10% ceramic capacitors (0402)
C2	1	10 μ F \pm 10% ceramic capacitor (0603)
C6, C17, C20	3	0.01 μ F \pm 10% ceramic capacitors (0402)
C7	1	4.7pF \pm 5% ceramic capacitor (0402)
C9	1	33pF \pm 10% ceramic capacitor (0402)
C10	1	27pF \pm 10% ceramic capacitor (0402)
J1, J3, J5	0	Not installed
J2, J48	2	Test points
J4	1	2-pin header, 0.1in. centers

DESIGNATION	QTY	DESCRIPTION
J6, J7, J18	3	SMA connectors
L1	1	2.7 μ H inductor
R1, R2	2	150 Ω \pm 5% resistors (0402)
R3	1	36 Ω \pm 5% resistor (0402)
R4	1	499 Ω \pm 1% resistor (0402)
R5, R6	0	Not installed
R11	1	10.5 Ω \pm 1% resistor (0402)
SW1, SW2	2	SPDT switches
TP6, TP7	2	Test points
U1	1	MAX3622CUE+
Y1	1	25MHz crystal NDK EXS00A-AT00429
None	1	Shunt
None	1	PCB: MAX3622 Board, Rev A

Evaluates: MAX3622

MAX3622 Evaluation Kit

Quick Start

To evaluate the MAX3622, configure the EV kit as follows:

- 1) Determine which output is going to be evaluated and connect to the test equipment through an SMA cable(s).
- 2) Connect a +3.3V power supply to J48 (VCC) and J2 (GND). Set the current limit to 200mA.
- 3) Enable the output under test by setting the related output-enable switch high.
- 4) The clock frequency at the LVCMOS output (QA_C) is 125MHz. The clock frequency at the LVPECL output is 156.25MHz.
- 5) Note that when the LVCMOS output is being evaluated, the amplitude seen on 50Ω test equipment is attenuated by the on-board circuitry. The voltage swing is approximately one-twelfth of what would be seen by directly connecting QA_C to a high-impedance input.

Table 1. Adjustment and Control Descriptions (see Quick Start first)

COMPONENT	NAME	FUNCTION
J4	INDUCTOR	J4 shunts the power-supply inductor. Normal operation is J4 shunted.
SW1	QB_OE	Set high to enable LVPECL output QB. Set low to force a logic zero at QB.
SW2	QAC_OE	Set high to enable LVPECL output QA. Set low to force a logic zero at QA.

MAX3622 Evaluation Kit

Evaluates: MAX3622

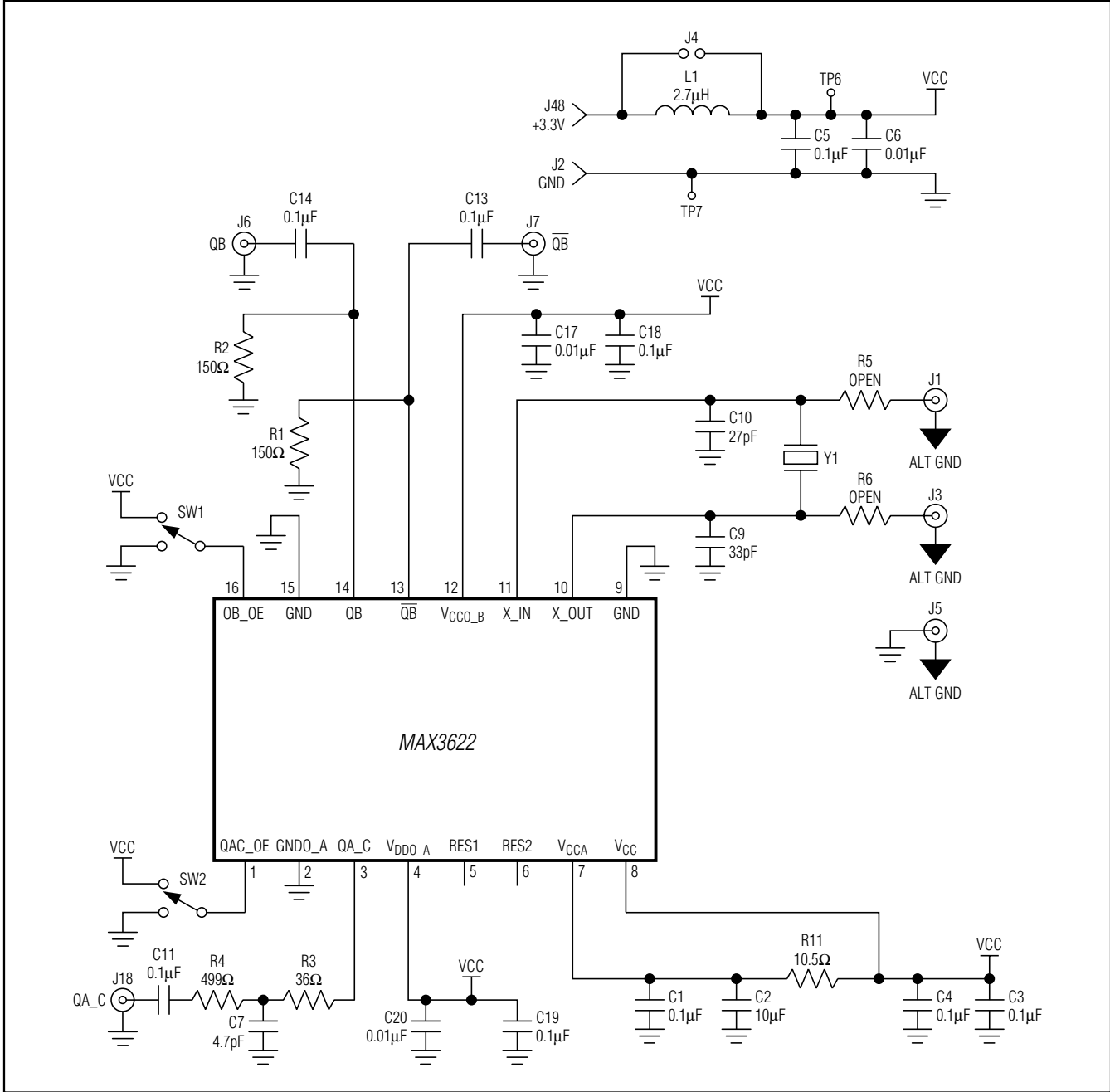

Figure 1. MAX3622 EV Kit Schematic

MAX3622 Evaluation Kit

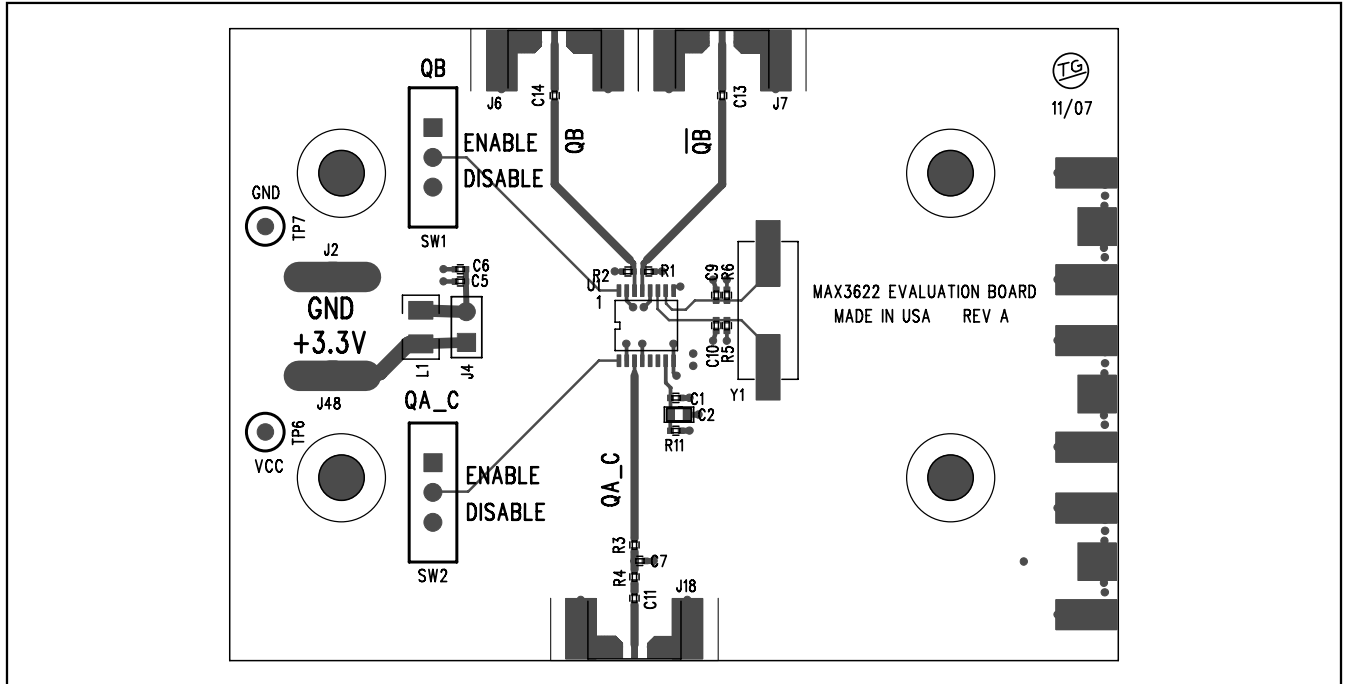

Figure 2. MAX3622 EV Kit Assembly Drawing—Top Side

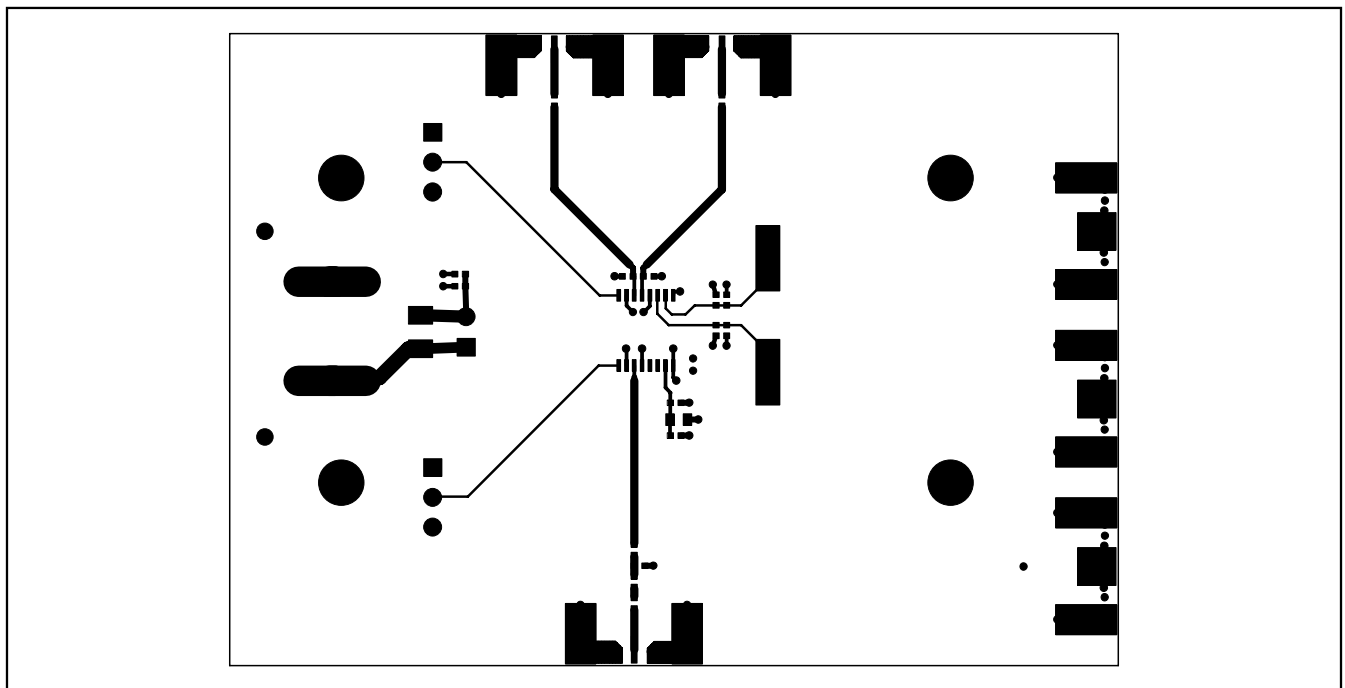

Figure 3. MAX3622 EV Kit Layout—Component Side

MAX3622 Evaluation Kit

Evaluates: MAX3622

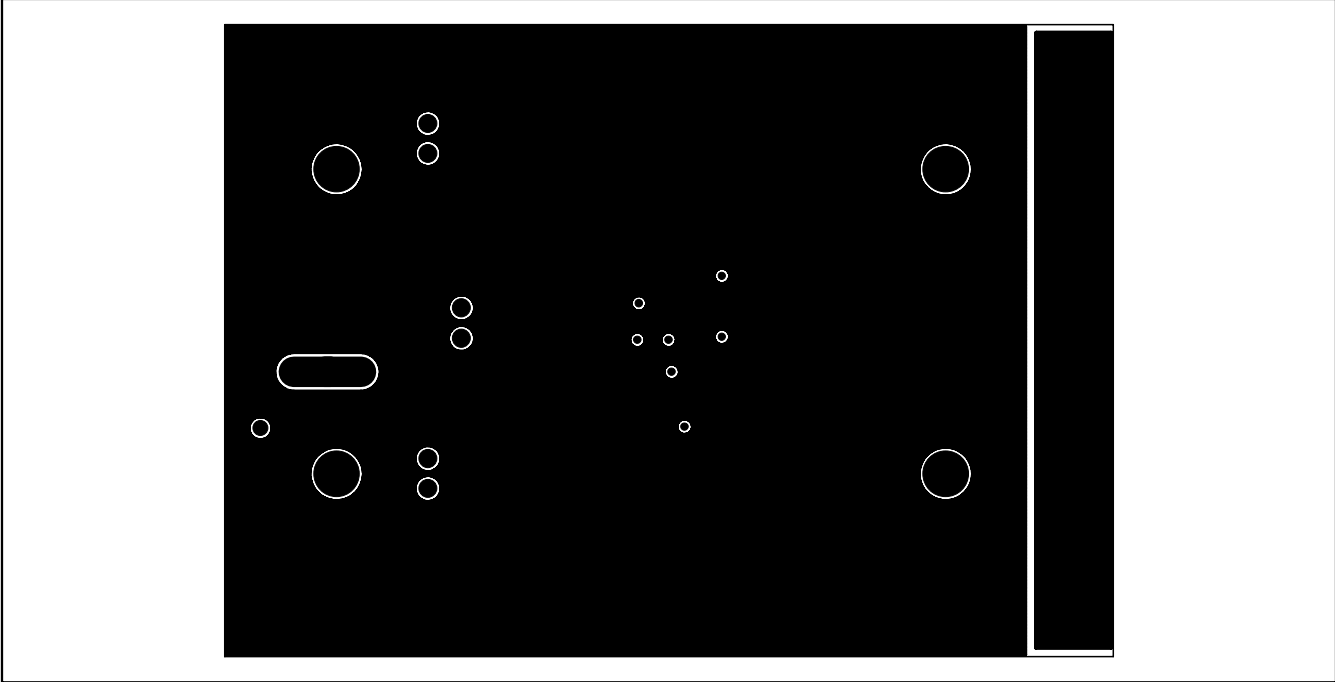

Figure 4. MAX3622 EV Kit Layout—Ground Plane

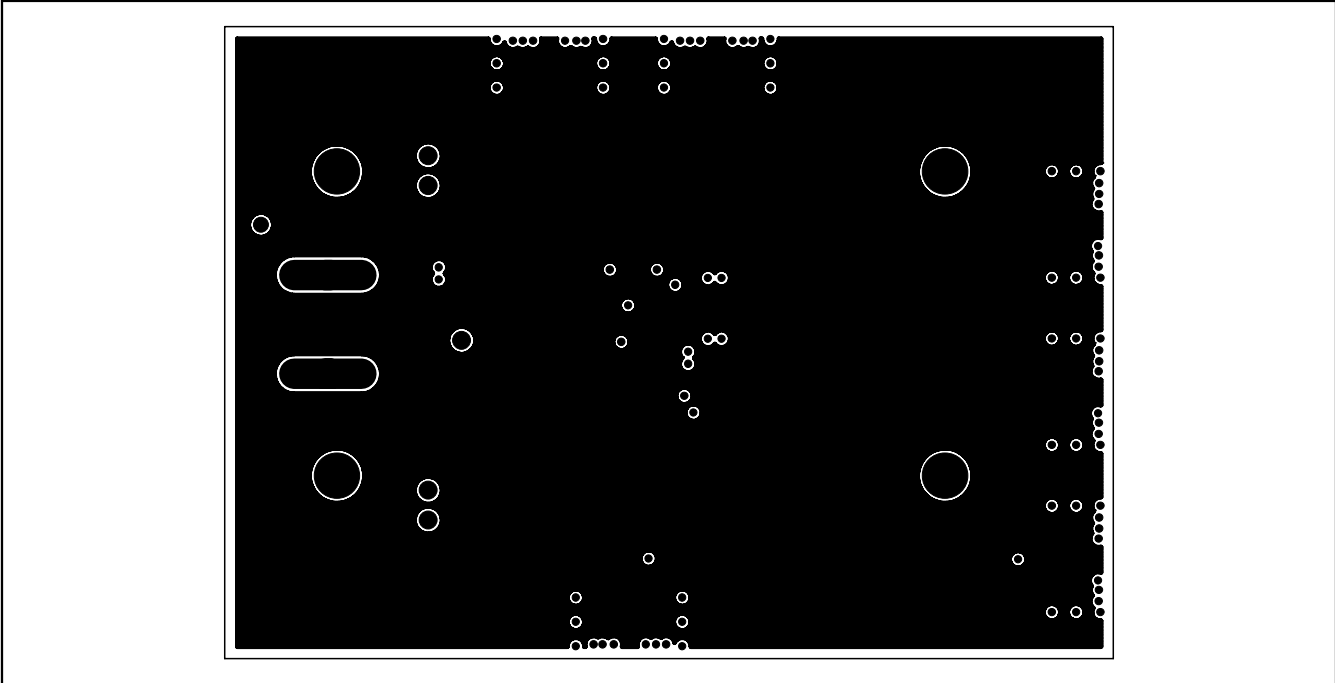

Figure 5. MAX3622 EV Kit Layout—Power Plane

MAX3622 Evaluation Kit

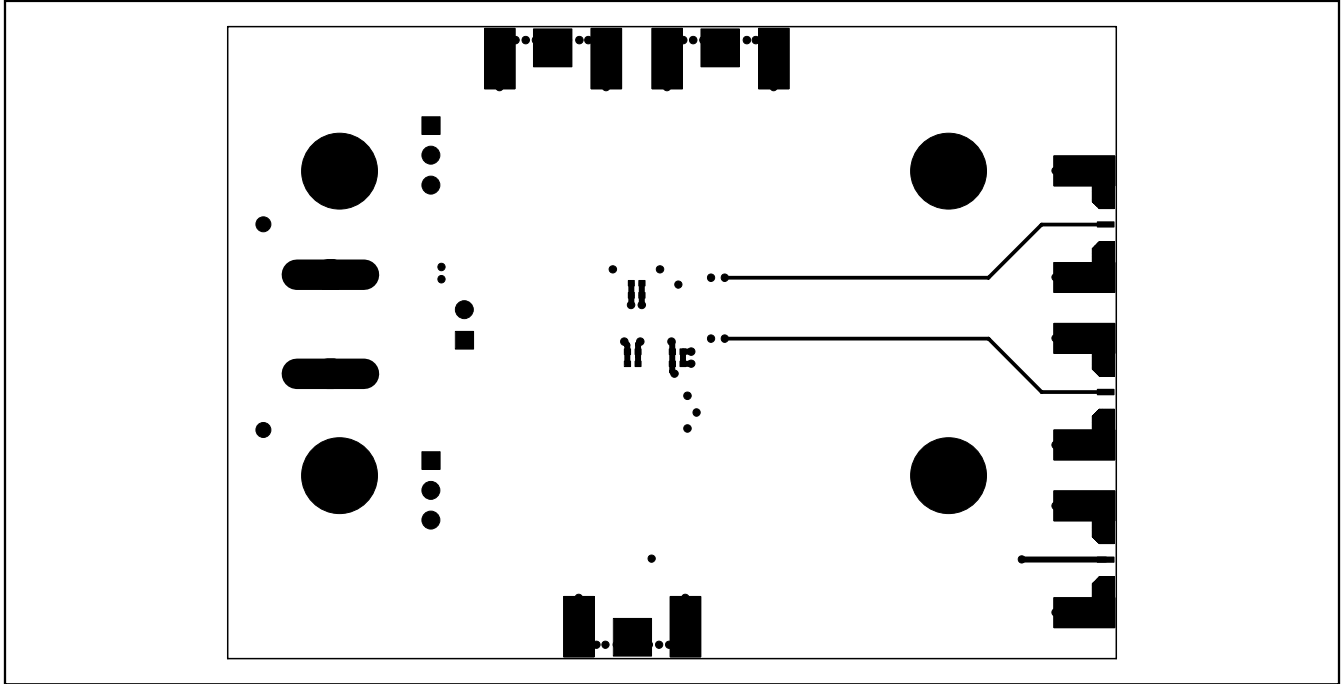

Figure 6. MAX3622 EV Kit Layout—Solder Plane

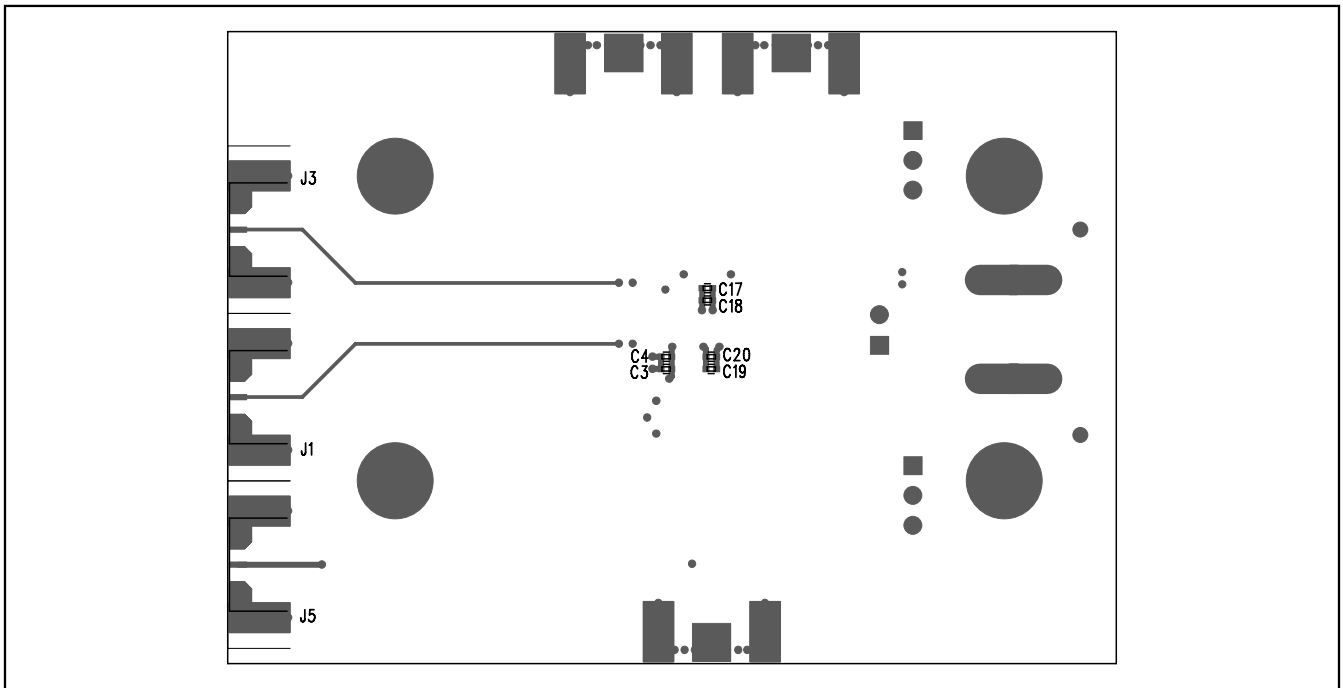

Figure 7. MAX3622 EV Kit Assembly Drawing—Bottom Side



Microsemi Corporate Headquarters
One Enterprise, Aliso Viejo CA 92656 USA
Within the USA: +1 (949) 380-6100
Sales: +1 (949) 380-6136
Fax: +1 (949) 215-4996

Microsemi Corporation (NASDAQ: MSCC) offers a comprehensive portfolio of semiconductor solutions for: aerospace, defense and security; enterprise and communications; and industrial and alternative energy markets. Products include high-performance, high-reliability analog and RF devices, mixed signal and RF integrated circuits, customizable SoCs, FPGAs, and complete subsystems. Microsemi is headquartered in Aliso Viejo, Calif. Learn more at www.microsemi.com.

© 2012 Microsemi Corporation. All rights reserved. Microsemi and the Microsemi logo are trademarks of Microsemi Corporation. All other trademarks and service marks are the property of their respective owners.