

MAX17623 MAX17624

2.9V to 5.5V, 1A, Synchronous Step-Down Converter with Integrated MOSFETs

General Description

The Himalaya series of voltage regulator ICs, power modules, and chargers enable cooler, smaller, and simpler power supply solutions. MAX17623 and MAX17624 are high-frequency synchronous Himalaya step-down DC-DC converters with integrated MOSFETs and internal compensation. MAX17623 and MAX17624 have an input-voltage range of 2.9V to 5.5V, supports up to 1A, and output voltage can be adjusted from 0.8V to 3.3V.

The MAX17623 and MAX17624 employ peak-current-mode control architecture under steady-state operation. To reduce input-inrush current, the devices offer a fixed 1ms soft-start time. Both devices feature selectable PWM for fixed frequency operation, or PFM mode for better efficiency at light loads. When PWM mode is selected, MAX17623 operates at a fixed 2MHz switching frequency and MAX17624 operates at a fixed 4MHz switching frequency. MAX17623 offers output voltages from 0.8V to 1.5V, and MAX17624 offers output voltages from 1.5V to 3.3V.

The MAX17623 and MAX17624 devices are available in a compact 8-pin, 2mm x 2mm TDFN package.

Applications

- Point-of-Load Power Supply
- Standard 5V Rail Supplies
- Battery-Powered Applications
- Distributed Power Systems
- Industrial Sensors and Process Control

Benefits and Features

- Easy to Use
 - 2.9V to 5.5V Input
 - Adjustable 0.8V to 3.3V Output
 - $\pm 1\%$ Feedback Accuracy
 - Up to 1A Output Current
 - Fixed 2MHz or 4MHz Operation
 - 100% Duty-Cycle Operation
 - Internally Compensated
 - All Ceramic Capacitors
- High Efficiency
 - Selectable PWM- or PFM-Mode of Operation
 - Shutdown Current as Low as 0.1 μ A (typ)
- Flexible Design
 - Internal Soft-Start and Prebias Startup
 - Open-Drain Power Good Output (PGOOD Pin)
- Robust Operation
 - Overtemperature Protection
 - Overcurrent Protection
 - -40°C to +125°C Ambient Operating Temperature/ -40°C to +150°C Junction Temperature

Ordering Information at end of data sheet.

Typical Application Circuit

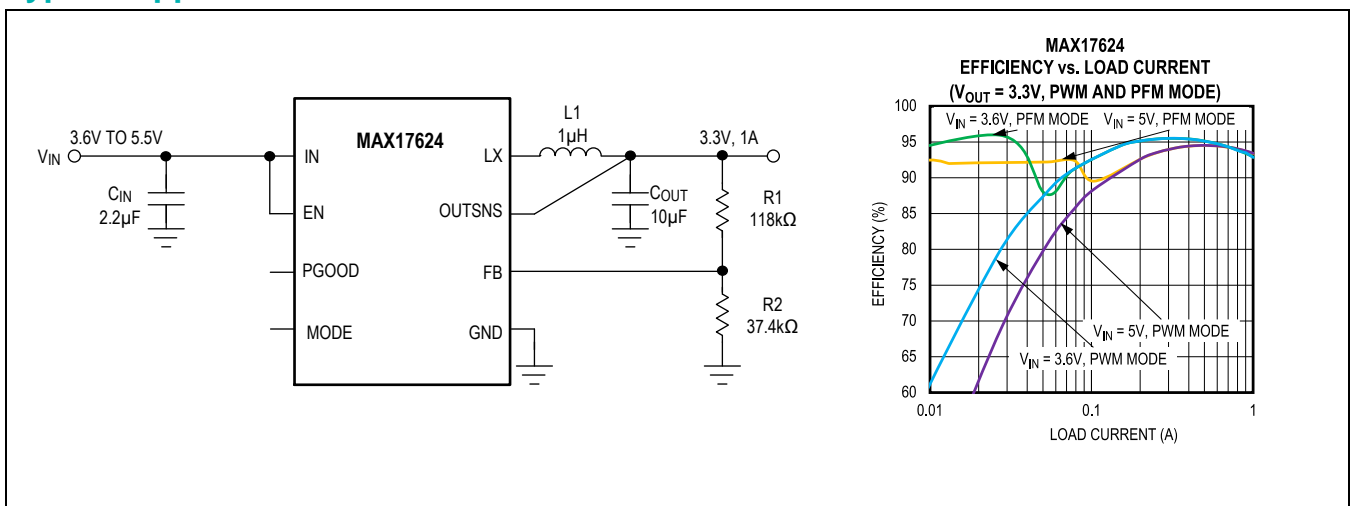

Absolute Maximum Ratings

IN, EN, PGOOD, FB, OUTSNS to GND -0.3V to 6V
 MODE, LX to GND -0.3V to (IN + 0.3V)
 Output Short-Circuit Duration Continuous
 Continuous Power Dissipation (up to $T_A = +70^\circ\text{C}$) (derate
 11.7mW/ $^\circ\text{C}$ above $T_A = +70^\circ\text{C}$) 937.9mW

Operating Temperature -40°C to $+125^\circ\text{C}$
 Junction Temperature (Note1) $+150^\circ\text{C}$
 Storage Temperature Range -65°C to $+150^\circ\text{C}$
 Lead Temperature (soldering, 10s) $+260^\circ\text{C}$
 Soldering Temperature (reflow) $+260^\circ\text{C}$

Note 1: Junction temperature greater than $+125^\circ\text{C}$ degrades operating lifetimes.

Stresses beyond those listed under "Absolute Maximum Ratings" may cause permanent damage to the device. These are stress ratings only, and functional operation of the device at these or any other conditions beyond those indicated in the operational sections of the specifications is not implied. Exposure to absolute maximum rating conditions for extended periods may affect device reliability.

Package Information

PACKAGE TYPE: 8- PIN TDFN

Package Code	T822+3C
Outline Number	21-0168
Land Pattern	90-0065
THERMAL RESISTANCE, FOUR-LAYER BOARD	
Junction to Ambient (θ_{JA})	85.3 $^\circ\text{C}/\text{W}$
Junction to Case (θ_{JC})	8.9 $^\circ\text{C}/\text{W}$

For the latest package outline information and land patterns (footprints), go to www.maximintegrated.com/packages. Note that a "+", "#", or "-" in the package code indicates RoHS status only. Package drawings may show a different suffix character, but the drawing pertains to the package regardless of RoHS status.

Package thermal resistances were obtained using the method described in JEDEC specification JESD51-7, using a four-layer board. For detailed information on package thermal considerations, refer to www.maximintegrated.com/thermal-tutorial.

Electrical Characteristics

($V_{IN} = V_{EN} = 3.6\text{V}$, $V_{GND} = V_{MODE} = V_{FB} = 0\text{V}$, $LX = OUTSNS = PGOOD = \text{OPEN}$. $T_A = T_J = -40^\circ\text{C}$ to $+125^\circ\text{C}$, unless otherwise noted. Typical values are at $T_A = +25^\circ\text{C}$. All voltages are referenced to GND, unless otherwise noted.) (Note 2)

PARAMETER	SYMBOL	CONDITIONS	MIN	TYP	MAX	UNITS
INPUT SUPPLY (V_{IN})						
Input-Voltage Range	V_{IN}		2.9		5.5	V
Input-Supply Current	$I_{IN-SHDN}$	$V_{EN} = 0$, shutdown mode		0.1		μA
	I_{Q-PFM}	PFM mode, No Load		40		
	I_{Q-PWM}	PWM mode, MAX17623			4.5	
PWM mode, MAX17624			6			
Undervoltage-Lockout Threshold (UVLO)	V_{IN_UVLO}	V_{IN} Rising	2.72	2.8	2.88	V
UVLO Hysteresis	$V_{IN_UVLO_HYS}$			200		mV
ENABLE(EN)						
EN LOW Threshold	V_{EN_LOW}	EN falling			0.8	V
EN HIGH Threshold	V_{EN_HIGH}	EN rising	2			V

MAX17623
MAX17624

2.9V to 5.5V, 1A, Synchronous Step-Down
Converter with Integrated MOSFETs

($V_{IN} = V_{EN} = 3.6V$, $V_{GND} = V_{MODE} = V_{FB} = 0V$, $LX = OUTSNS = PGOOD = OPEN$. $T_A = T_J = -40^{\circ}C$ to $+125^{\circ}C$, unless otherwise noted. Typical values are at $T_A = +25^{\circ}C$. All voltages are referenced to GND, unless otherwise noted.) (Note 2)

PARAMETER	SYMBOL	CONDITIONS	MIN	TYP	MAX	UNITS
EN Input Leakage	I_{EN}	EN = 5.5V, $T_A = T_J = +25^{\circ}C$		10	50	nA
POWER MOSFETS						
High-Side pMOS On-Resistance	R_{DS_ONH}	$V_{IN} = 3.6V$, $I_{OUT} = 190mA$		120	200	m Ω
		$V_{IN} = 5V$, $I_{OUT} = 190mA$		100	160	
Low-Side nMOS On-Resistance	R_{DS_ONL}	$V_{IN} = 3.6V$, $I_{OUT} = 190mA$		80	145	m Ω
		$V_{IN} = 5V$, $I_{OUT} = 190mA$		70	130	
LX Leakage Current	I_{LX_LKG}	LX = GND or IN, $T_A = +25^{\circ}C$		0.1	1	μA
TIMING						
Switching Frequency	f_{SW}	MAX17623	1.92	2.00	2.08	MHz
		MAX17624	3.84	4.00	4.16	
Minimum On Time	t_{ON_MIN}			40		ns
Maximum Duty Cycle	D_{MAX}				100	%
LX Dead Time				3		ns
Soft-Start Time	t_{SS}			1		ms
FEEDBACK (FB)						
FB Regulation Voltage	V_{FB_REG}			0.8		V
FB Voltage Accuracy	V_{FB}	PWM Mode	-1		+1	%
FB Input-Bias Current	I_{FB}	FB = 0.6V, $T_A = T_J = +25^{\circ}C$		50		nA
OUTSNS Input Bias Current	I_{OUTSNS_BIAS}	MAX17623 $V_{OUTSNS} = 5.5V$		20		nA
		MAX17624 $V_{OUTSNS} = 5.5V$		10		μA
CURRENT LIMIT						
Peak Current-Limit Threshold	I_{LIM_PEAK}		1.4	2	2.5	A
Valley Current-Limit Threshold	I_{LIM_VALLEY}		1.2	1.5	1.8	A
Negative Current-Limit Threshold	I_{LIM_NEG}	Current entering LX pin		-1.09		A
POWER GOOD (PGOOD)						
PGOOD Rising Threshold	V_{PGOOD_RISE}	FB Rising	91.5	93.5	95.5	%
PGOOD Falling Threshold	V_{PGOOD_FALL}	FB Falling	88	90	92	%
PGOOD Output Low	V_{OL_PGOOD}	$I_{PGOOD} = 5mA$			200	mV
PGOOD Output Leakage Current	I_{LEAK_PGOOD}	PGOOD = 5.5V, $T_A = T_J = +25^{\circ}C$			100	nA
Delay in PGOOD Assertion after Soft-Start				184		μs
MODE						
MODE Pullup Current		$V_{MODE} = GND$		5		μA

MAX17623 MAX17624

2.9V to 5.5V, 1A, Synchronous Step-Down Converter with Integrated MOSFETs

($V_{IN} = V_{EN} = 3.6V$, $V_{GND} = V_{MODE} = V_{FB} = 0V$, $LX = OUTSNS = PGOOD = OPEN$. $T_A = T_J = -40^{\circ}C$ to $+125^{\circ}C$, unless otherwise noted. Typical values are at $T_A = +25^{\circ}C$. All voltages are referenced to GND, unless otherwise noted.) (Note 2)

PARAMETER	SYMBOL	CONDITIONS	MIN	TYP	MAX	UNITS
THERMAL SHUTDOWN						
Thermal-Shutdown Rising Threshold				165		$^{\circ}C$
Thermal-Shutdown Hysteresis				10		$^{\circ}C$

Note 2: Electrical specifications are production tested at $T_A = +25^{\circ}C$. Specifications over the entire operating temperature range are guaranteed by design and characterization.

Typical Operating Characteristics

($V_{IN} = V_{EN} = 5V$, $V_{GND} = V_{MODE} = V_{FB} = V_{OUTSNS} = 0V$, $LX = PGOOD = OPEN$, $T_A = T_J = -40^{\circ}C$ to $+125^{\circ}C$, unless otherwise noted. Typical values are at $T_A = +25^{\circ}C$. All voltages are referenced to GND, unless otherwise noted.)

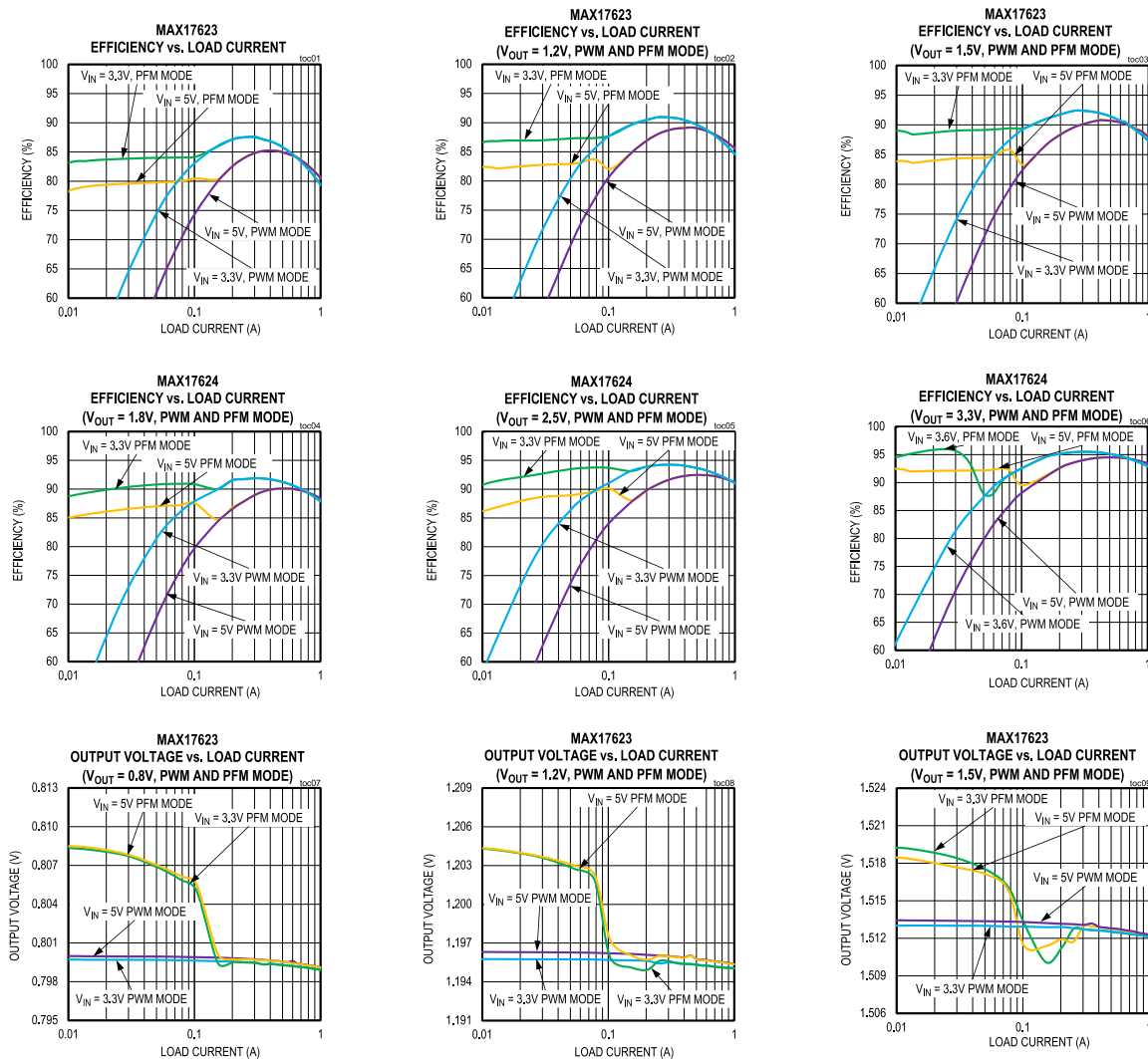

MAX17623 MAX17624

2.9V to 5.5V, 1A, Synchronous Step-Down Converter with Integrated MOSFETs

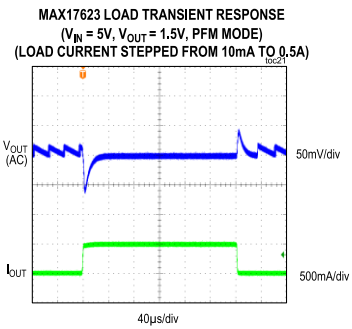
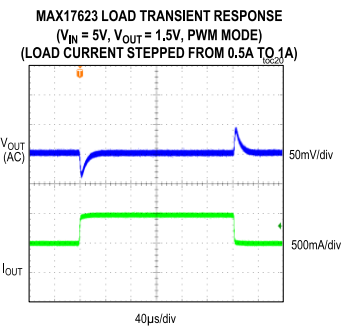
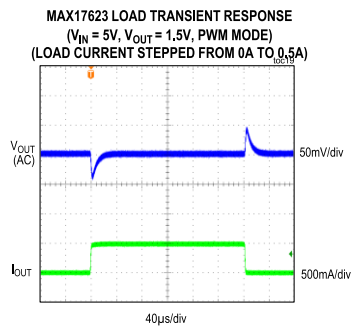
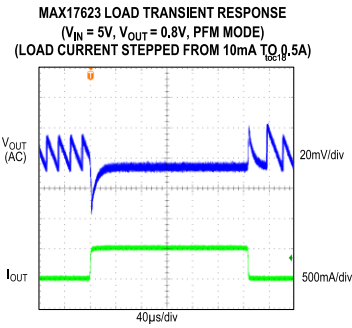
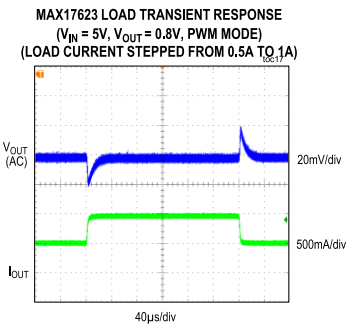
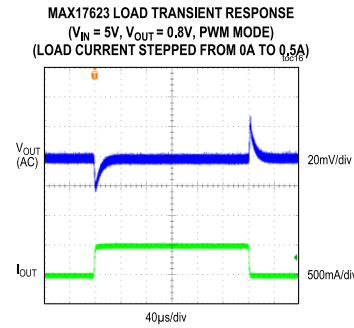
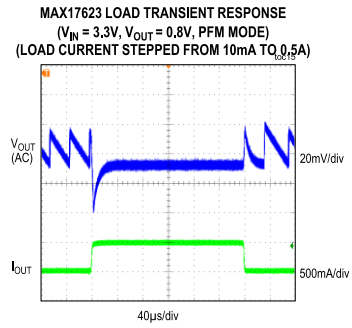
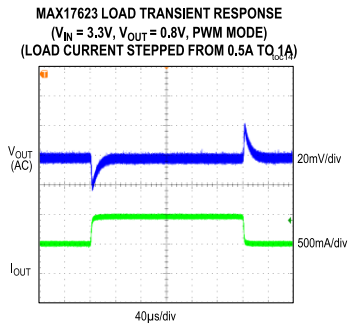
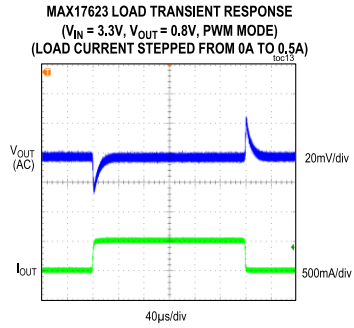
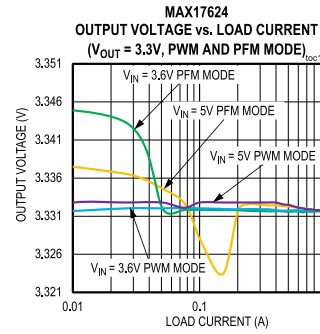
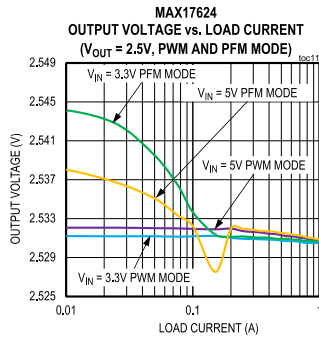
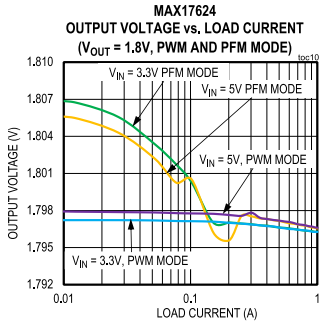

MAX17623
MAX17624

2.9V to 5.5V, 1A, Synchronous Step-Down Converter with Integrated MOSFETs

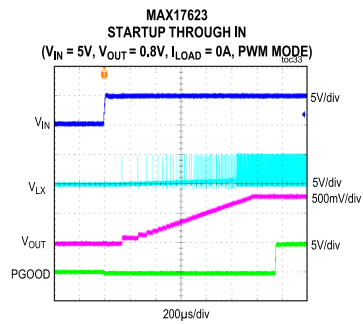
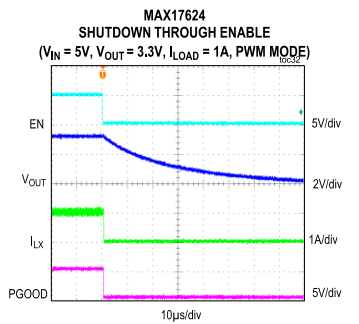
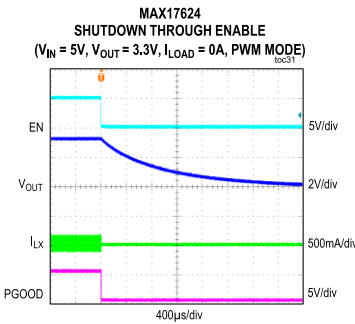
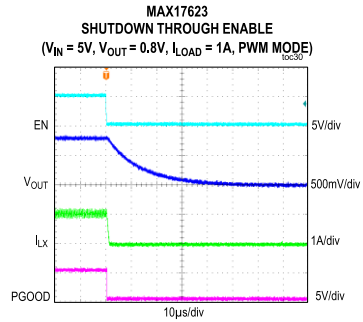
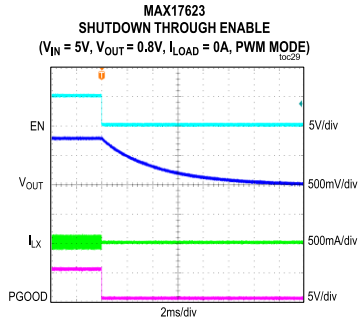
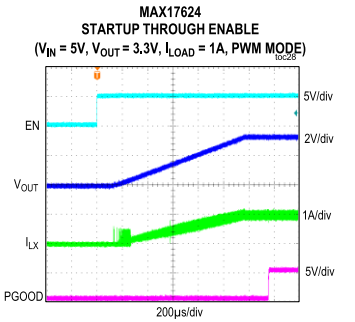
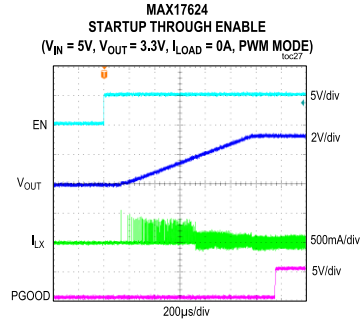
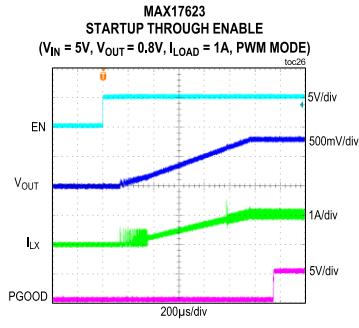
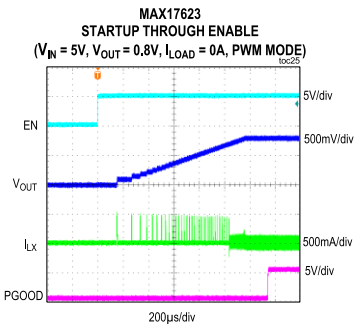
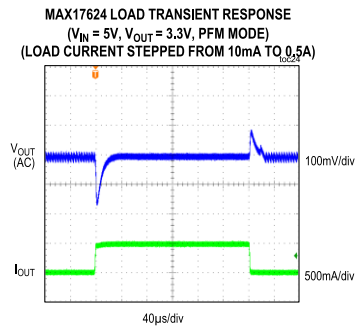
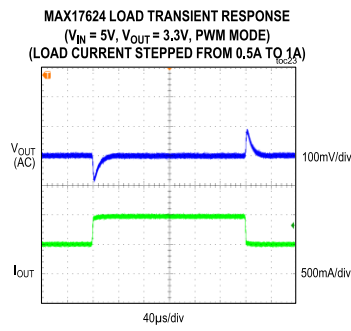
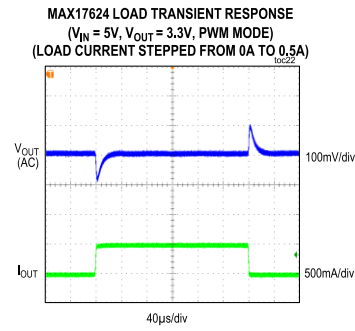

MAX17623
MAX17624

2.9V to 5.5V, 1A, Synchronous Step-Down Converter with Integrated MOSFETs

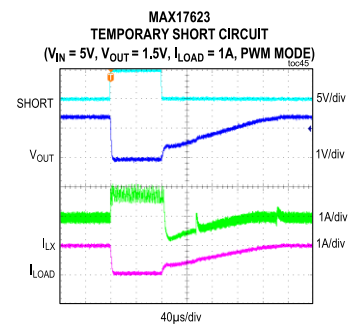
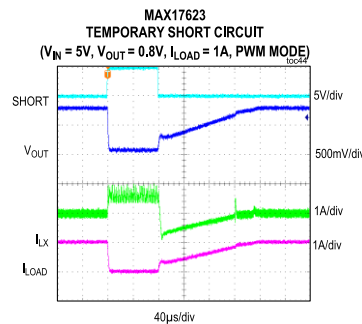
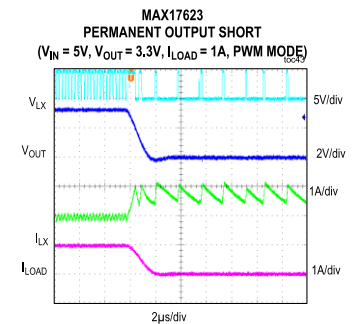
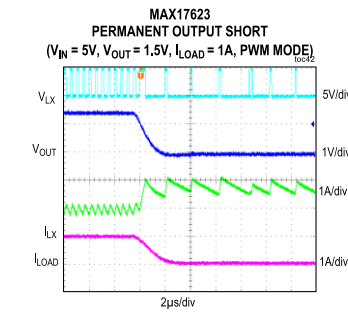
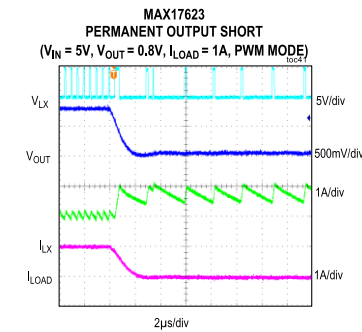
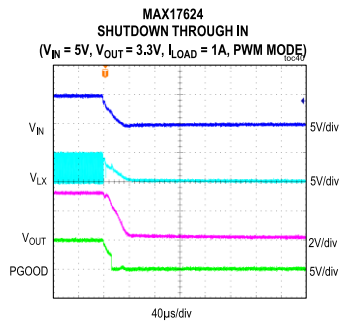
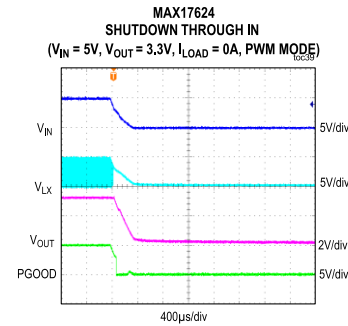
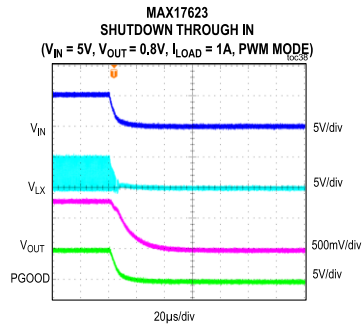
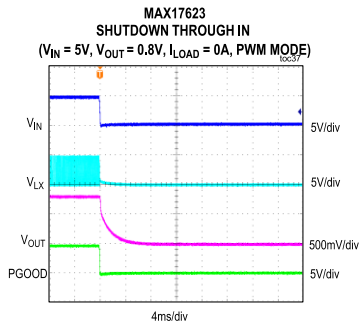
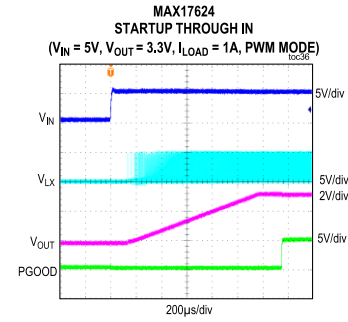
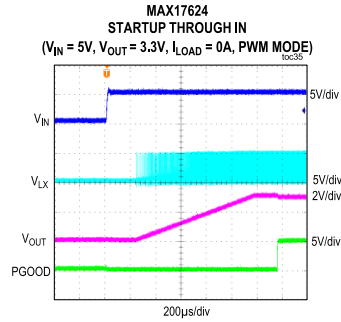
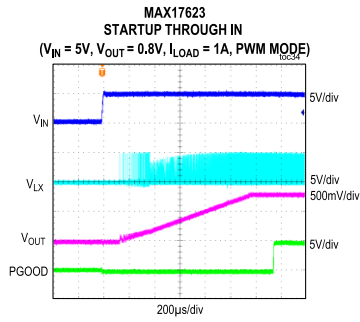

MAX17623 MAX17624

2.9V to 5.5V, 1A, Synchronous Step-Down Converter with Integrated MOSFETs

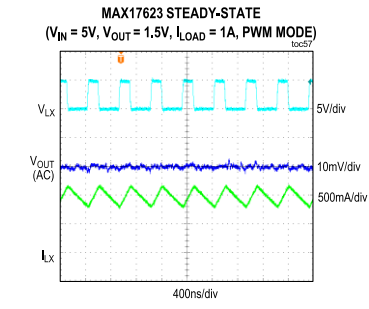
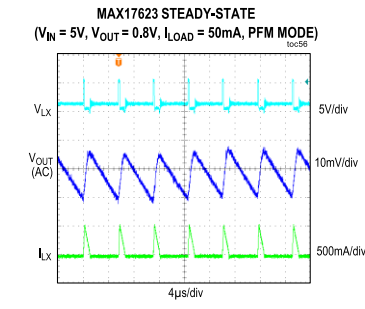
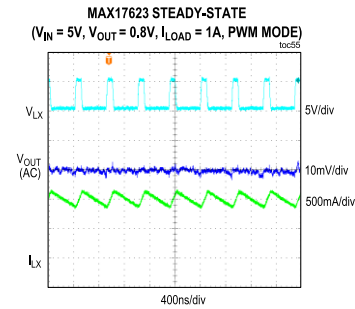
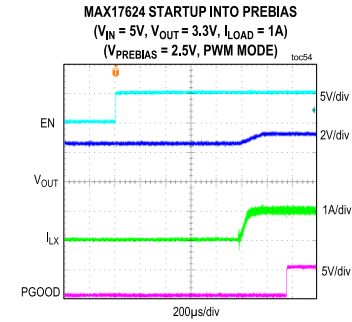
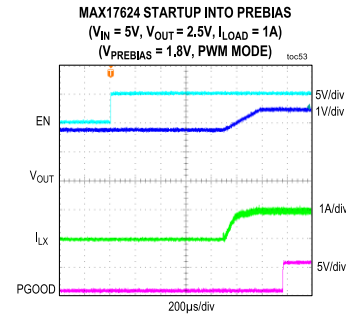
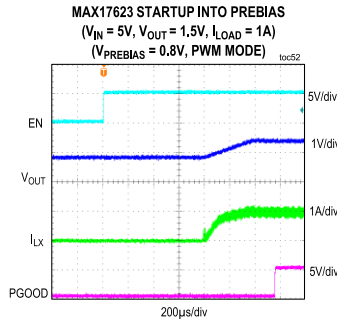
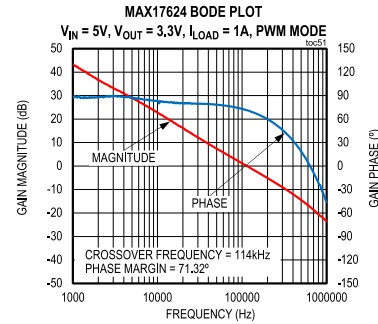
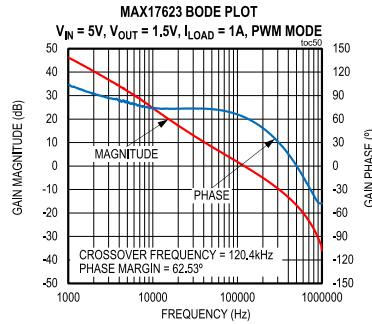
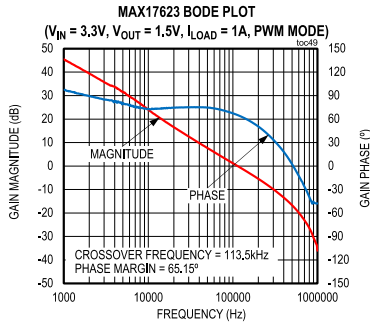
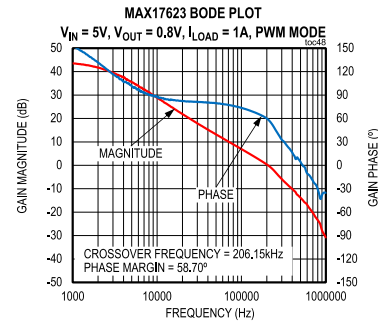
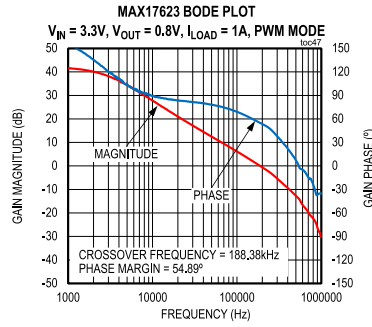
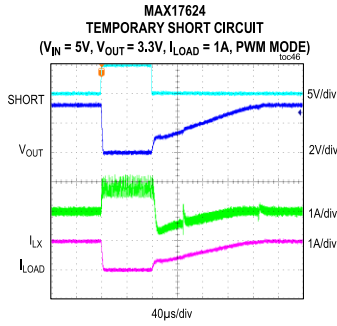

MAX17623 STEADY-STATE
($V_{IN} = 5V$, $V_{OUT} = 1.5V$, $I_{LOAD} = 50mA$, PFM MODE)

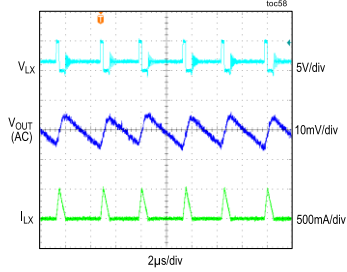

MAX17624 STEADY-STATE
($V_{IN} = 5V$, $V_{OUT} = 2.5V$, $I_{LOAD} = 1A$, PWM MODE)

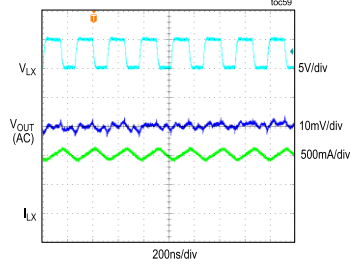

MAX17624 STEADY-STATE
($V_{IN} = 5V$, $V_{OUT} = 2.5V$, $I_{LOAD} = 50mA$, PFM MODE)

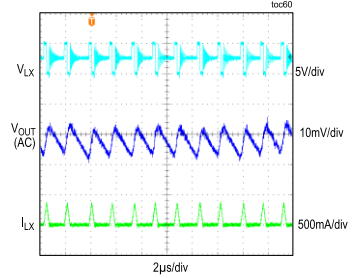

MAX17624 STEADY-STATE
($V_{IN} = 5V$, $V_{OUT} = 3.3V$, $I_{LOAD} = 1A$, PWM MODE)

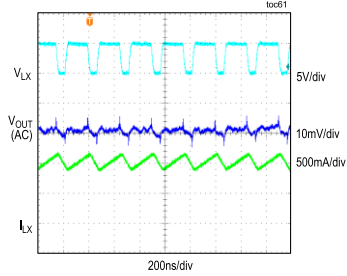

MAX17624 STEADY-STATE
($V_{IN} = 5V$, $V_{OUT} = 3.3V$, $I_{LOAD} = 50mA$, PFM MODE)

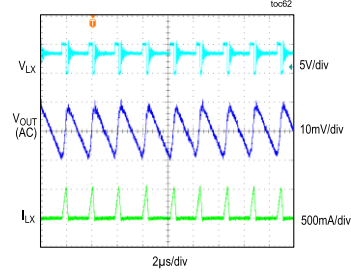

Pin Configurations

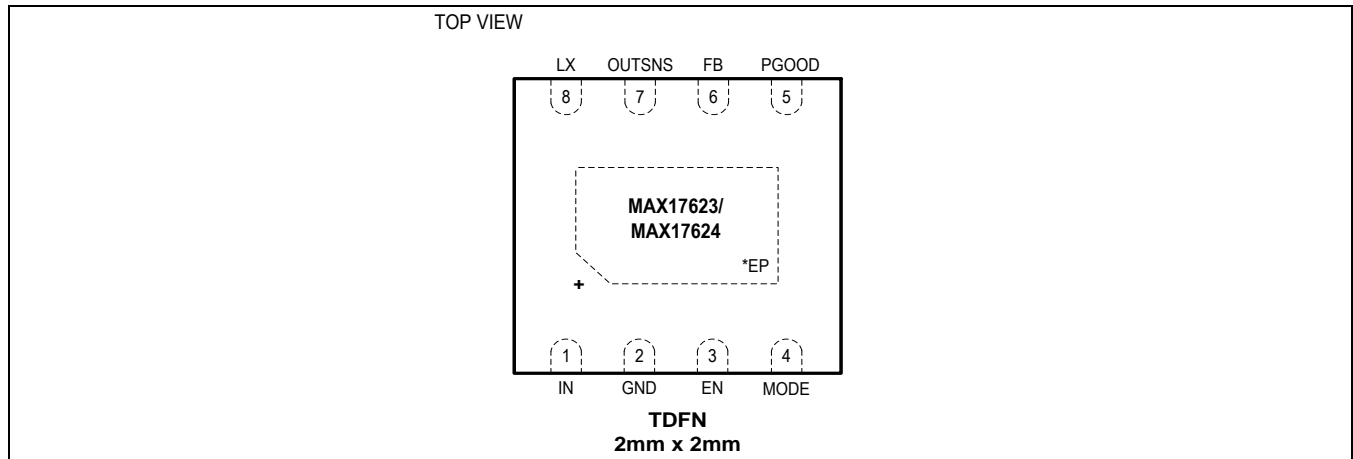

Pin Descriptions

PIN	NAME	FUNCTION
1	IN	Power Supply Input. Decouple the IN pin to GND with a capacitor. Place the capacitor close to the IN and GND pins.
2	GND	Ground Pin of the converter. Connect externally to the power ground plane. Refer to the MAX17623/MAX17624 evaluation kit data sheet for a layout example.
3	EN	Active High Enable Input Pin. Connect to IN for always ON operation. Connect to GND to disable the output.
4	MODE	PWM or PFM Mode Selection Input. Connect the MODE pin to GND to enable PWM mode operation. Leave the MODE pin unconnected to enable PFM mode of operation.
5	PGOOD	Open- Drain Output Power Good Status Pin. Pullup PGOOD to an external logic supply using a pullup resistor to generate a "high" level if the output voltage is above 93.5% of the target regulated voltage. If not used, leave this pin unconnected. The PGOOD is driven low if the output voltage is below 90% of the target regulated voltage
6	FB	Feedback Input. Connect FB to the center of the external resistor-divider from the output-voltage node (V_{OUT}) to GND to set the output voltage.
7	OUTSNS	Sense Pin for Output Voltage. Connect to the positive terminal of the output capacitor C_{OUT} through a Kelvin connection.
8	LX	Switching Node. Connect the LX pin to the switching node of the inductor.
—	EP	Exposed Pad. Connect the exposed pad to the GND pin of the device. Also, connect EP to a large GND plane with several thermal vias for the best thermal performance. Refer to the MAX17623/MAX17624 evaluation kit data sheet for an example of the correct method of EP connection and thermal vias.

Functional Diagram

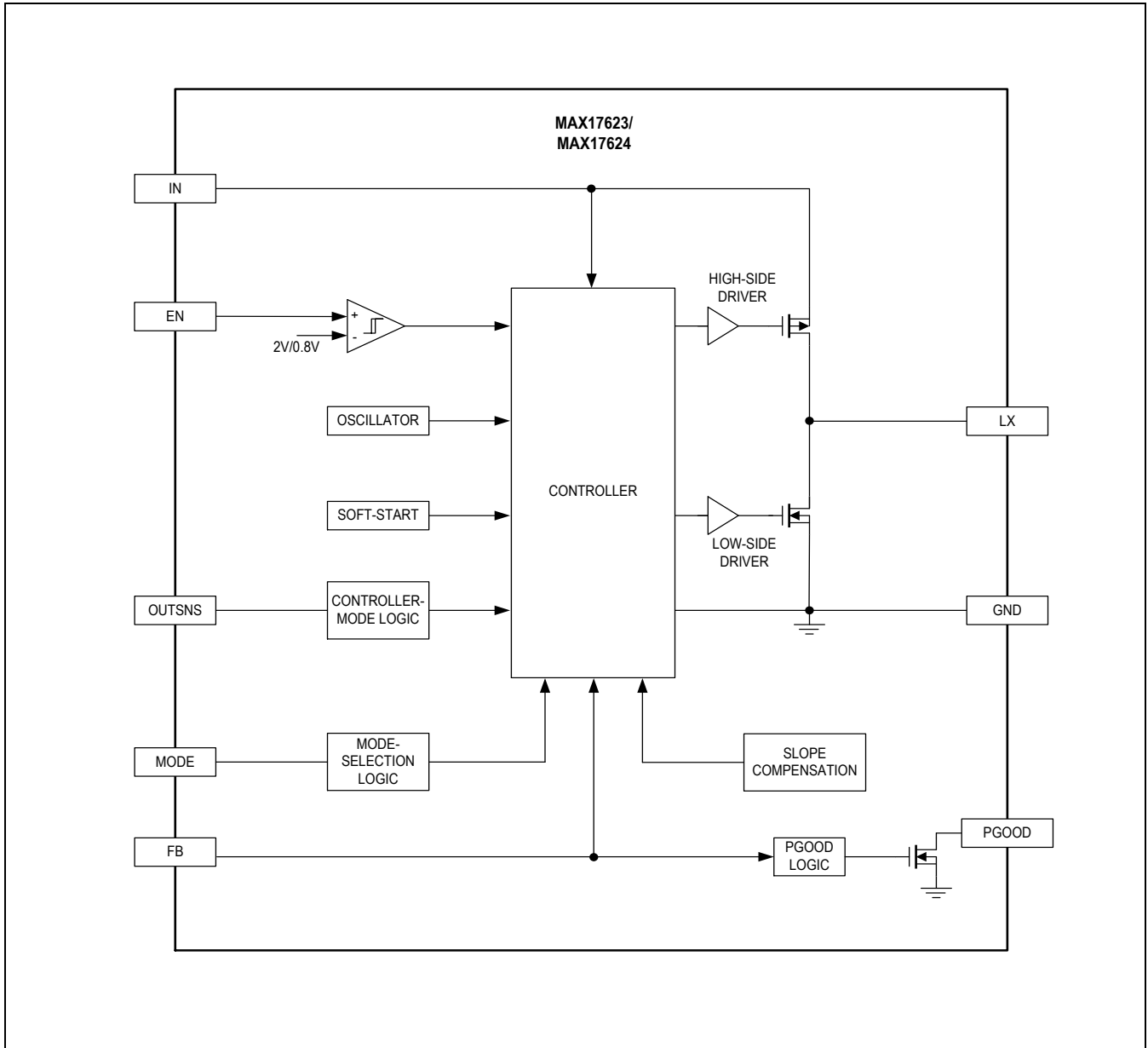

Detailed Description

MAX17623 and MAX17624 are high-frequency synchronous step-down DC-DC converters, with integrated MOSFETs and compensation components, that operate over a 2.9V to 5.5V input-voltage range. MAX17623 and MAX17624 support up to 1A load current and allows use of small, low-cost input and output capacitors. The output voltage can be adjusted from 0.8V to 3.3V.

When the EN pin is asserted, an internal power-up sequence ramps up the error-amplifier reference, resulting in output-voltage soft-start. The FB pin monitors the output voltage through a resistor-divider. The devices select either PFM or forced-PWM mode depending on the state of the MODE pin at power-up. By pulling the EN pin to low, the devices enter shutdown mode and consume only 0.1 μ A (typ) of standby current.

The devices use an internally compensated, fixed-frequency, peak-current mode control scheme. On the falling edge of an internal clock, the high-side pMOSFET turns on, and continues to be on during normal operation until at least the rising edge of the clock (for 40ns). An internal error amplifier compares the feedback voltage to a fixed internal reference voltage and generates an error voltage. The error voltage is compared to a sum of the current-sense voltage and a slope-compensation voltage by a PWM comparator to set the on-time. During the on-time of the pMOSFET, the inductor current ramps up. For the remainder of the switching period (off-time), the pMOSFET is kept off and the low-side nMOSFET turns on. During the off-time, the inductor releases the stored energy as the inductor current ramps down, providing current to the output. Under overload conditions, the cycle-by-cycle current-limit feature limits the inductor peak current by turning off the high-side pMOSFET and turning on the low-side nMOSFET.

Mode Selection (MODE)

The logic state of the MODE pin is latched after the EN pin goes above its rising threshold and all internal voltages are ready to allow LX switching. If the MODE pin is unconnected at power-up, the part operates in PFM mode at light loads. If the MODE pin is grounded at power-up, the part operates in constant-frequency PWM mode at all loads. State changes on the MODE pin are ignored during normal operation.

PWM Operation

In PWM mode, the device output current is allowed to go negative. PWM operation is useful in frequency sensitive applications and provides fixed switching frequency operation at all loads. However, PWM-mode of operation gives lower efficiency at light loads compared to PFM-mode of operation.

PFM Operation

PFM mode of operation disables negative output current from the device and skips pulses at light loads for better efficiency. At low-load currents, if the peak value of the inductor current is less than 350mA for 64 consecutive cycles, and the inductor current reaches zero, the part enters PFM mode. In PFM mode, When the FB pin voltage is below 0.8V, the high-side switch is turned on until the inductor current reaches 500mA. After the high-side switch is turned OFF, the low-side switch is turned ON until the inductor current comes down to zero and LX enters a high-impedance state. If the FB pin voltage is greater than 0.8V for 3 consecutive CLK falling edges after LX enters a high-impedance state, the device continues to operate in PFM mode. In PFM mode, the part hibernates when the FB pin voltage is above 0.8V for 5 consecutive switching cycles after LX enters a high-impedance state. If the FB pin voltage drops below 0.8V within 3 consecutive CLK falling edges after LX enters a high-impedance state, the part comes out of PFM mode.

EN Input (EN), Soft-Start

When the EN pin voltage is above 2V (min), the internal error-amplifier reference voltage starts to ramp up. The duration of the soft-start ramp is 1ms (typ), allowing a smooth increase of the output voltage. Driving EN low disables both power MOSFETs, as well as other internal circuitry, and reduces IN quiescent current to below 0.1 μ A.

Power Good (PGOOD)

The devices include an open-drain power good output that indicates the output voltage status. PGOOD goes high when the output voltage is above 93.5% of the target value and goes low when the output voltage is below 90% of the target value. During startup, the PGOOD pin goes high after 184 μ s of soft-start completion.

Startup into a Prebiased Output

The devices are capable of soft-start into a prebiased output, without discharging the output capacitor in both the PFM and forced-PWM modes. Such a feature is useful in applications where digital integrated circuits with multiple rails are powered.

100% Duty Cycle Operation

The device can provide 100% duty-cycle operation. In this mode, the high-side switch is constantly turned on, while the low-side switch is turned off. This is particularly useful in battery-powered applications to achieve the longest operation time by taking full advantage of the whole battery-voltage range. The minimum input voltage to maintain the output-voltage regulation can be calculated as:

$$V_{IN_MIN} = V_{OUT} + (I_{OUT} \times R_{ON})$$

where,

V_{IN} = Minimum input voltage

V_{OUT} = Target output voltage

R_{ON} = Sum of the high-side FET on-resistance and the output inductor DCR

Undervoltage Lockout

The device features an integrated input undervoltage lockout (UVLO) feature that turns the device on/off based on the voltage at the IN pin. The device turns on if the IN pin voltage is higher than the UVLO threshold (V_{IN_UVLO}) of 2.8V (typ) (assuming EN is at logic-high) and turns off when the IN pin voltage is 200mV ($V_{IN_UVLO_HYS}$) below the V_{IN_UVLO} .

Overcurrent Protection

The MAX17623/MAX17624 are provided with a robust overcurrent protection (OCP) scheme that protects the devices under overload and output short-circuit conditions. When overcurrent is detected in the inductor, the switches are controlled by a mechanism, which detects both the high-side MOSFET and low-side MOSFET currents and compares them with the respective limits. Whenever the inductor current exceeds the internal peak current limit of 2A (typ), the high-side MOSFET is turned off and the low-side MOSFET is turned ON. The low-side MOSFET is kept on until the subsequent CLK rising edge after the inductor current drops below 1.5A (typ). The high-side MOSFET is turned on after the low-side MOSFET is turned off and the cyclic operation continues. When the overload condition is removed, the part regulates output to the set voltage.

Thermal Overload Protection

Thermal overload protection limits the total power dissipation in the device. When the junction temperature exceeds +165°C, an on-chip thermal sensor shuts down the device, turns off the internal power MOSFETs, allowing the device to cool down. The thermal sensor turns the device on after the junction temperature cools by 10°C.

Applications Information

Selection of Inductor

Three key inductor parameters must be specified to select the output inductor:

- 1) Inductor value
- 2) Inductor saturation current
- 3) DC-resistance of the inductor

The device internal slope compensation and current limit are optimized with output inductors of 1.5μH for MAX17623 and 1μH for MAX17624. For MAX17623, select a 1.5μH inductor and for MAX17624, select a 1μH inductor. The saturation current rating (I_{SAT}) of the inductor must be high enough to ensure that saturation can occur only above the peak current-limit value of 2A (typ). Select a low-loss inductor with acceptable dimensions and having the lowest possible DC-resistance to improve the efficiency.

Selection of Input Capacitor

The input filter capacitor reduces peak currents drawn from the power source and reduces noise and voltage ripple on the input caused by the circuit switching. The input capacitor RMS current requirement (I_{RMS}) is defined by the following equation:

$$I_{RMS} = I_{OUT(MAX)} \times \frac{\sqrt{V_{OUT} \times (V_{IN} - V_{OUT})}}{V_{IN}}$$

where,

$I_{OUT(MAX)}$ is the maximum load current. I_{RMS} has the maximum value when the input voltage equals twice the output voltage ($V_{IN} = 2 \times V_{OUT}$), so $I_{RMS(MAX)} = I_{OUT(MAX)}/2$.

Choose an input capacitor that exhibits less than +10°C temperature rise at the RMS input current for optimal long-term reliability. Use low-ESR ceramic capacitors with high-ripple-current capability at the input. X7R capacitors are recommended in industrial applications for their temperature stability. Calculate the input capacitance using the following equation:

$$C_{IN} = I_{OUT(MAX)} \times \frac{D \times (1 - D)}{f_{SW} \times \eta \times \Delta V_{IN}}$$

where,

D = Duty ratio of the converter

f_{SW} = Switching frequency

ΔV_{IN} = Allowable input-voltage ripple

η = Efficiency

Selection of Output Capacitor

Small ceramic X7R-grade capacitors are sufficient and recommended for the device. The output capacitor has two functions. It filters the square wave generated by the device along with the inductor. It stores sufficient energy to support the output voltage under load transient conditions and stabilizes the device's internal control loop. The device's internal loop-compensation parameters are optimized for 22μF and 10μF output capacitors for MAX17623 and MAX17624, respectively. MAX17623 requires a minimum of 22μF (typ) and MAX17624 requires a minimum of 10μF (typ) capacitance for stability. Derating of ceramic capacitors with DC-voltage must be considered while selecting the output capacitor.

Adjusting the Output Voltage

The MAX17623/MAX17624 output voltage can be programmed from 0.8V to 3.3V. MAX17623 offers output voltages from 0.8V to 1.5V and MAX17624 offers output voltages from 1.5V to 3.3V. Set the output voltage by connecting a resistor-divider from output to FB to GND (see [Figure 1](#)). Choose R2 to be less than 37.4kΩ and calculate R1 with the following equation:

$$R1 = R2 \times \left[\frac{V_{OUT}}{0.8} - 1 \right]$$

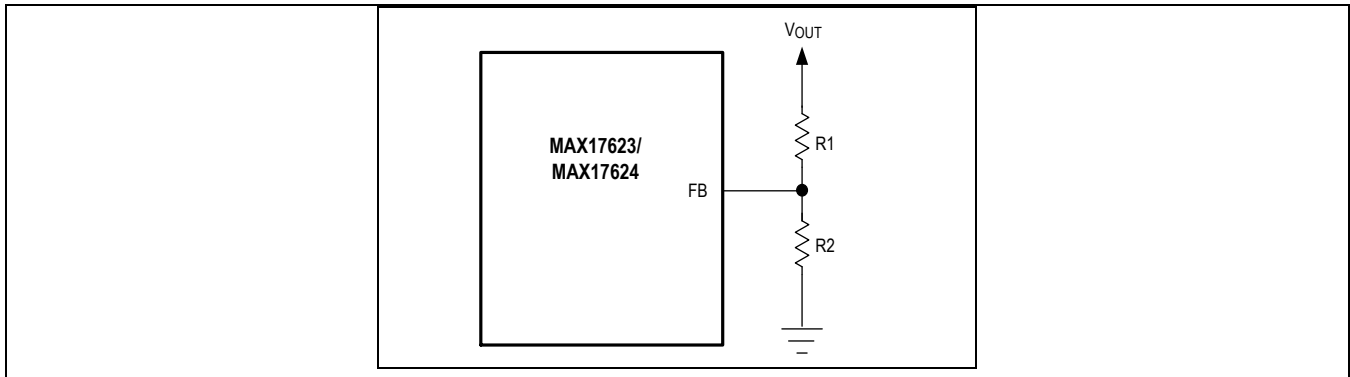

Figure 1. Setting the Output Voltage

Power Dissipation

At a particular operating condition, the power losses that lead to a temperature rise of the part are estimated as follows:

$$P_{LOSS} = P_{OUT} \times \left(\frac{1}{\eta} - 1 \right) - (I_{OUT}^2 \times R_{DCR})$$

$$P_{OUT} = V_{OUT} \times I_{OUT}$$

where,

P_{OUT} = Output Power

R_{DCR} = DC-resistance of the inductor

η = Efficiency of the power supply at the desired operating conditions. See the [Typical Operating Characteristics](#) section for efficiency or measure the efficiency to determine total power dissipation. An EE-Sim model is available for the MAX17623/MAX17624 to simulate efficiency and power loss.

The junction temperature T_J can be estimated at any given maximum ambient temperature T_A from the following equation:

$$T_J = T_A + (\theta_{JA} \times P_{LOSS})$$

Where θ_{JA} is the junction-to-ambient thermal resistance of the package (85.3°C/W for a four-layer board measured using JEDEC specification JESD51-7)

If the application has a thermal-management system that ensures the exposed pad of the device is maintained at a given temperature (T_{EP}), the junction temperature can be estimated using the following formula

$$T_J = T_{EP} + (\theta_{JC} \times P_{LOSS})$$

where θ_{JC} is the junction-to-case thermal resistance of the device (8.9°C/W)

Note: Operating the device at junction temperatures greater than +125°C degrades operating lifetimes.

PCB Layout Guidelines

Careful PCB layout is critical to achieve clean and stable operation. In particular, the traces that carry pulsating current should be short and wide so that the parasitic inductance formed by these traces can be minimized. Follow the following guidelines for good PCB layout:

- Keep the input capacitors as close as possible to the IN and GND pins.
- Keep the output capacitors as close as possible to the OUT and GND pins.
- Keep the resistive feedback divider as close as possible to the FB pin.
- Connect all the GND connections to a copper plane area as large as possible on the top and bottom layers.
- Use multiple vias to connect internal GND planes to the top layer GND plane.
- Keep the power traces and load connections short. This practice is essential for high efficiency. Using thick copper PCBs (2oz vs. 1oz) can enhance full load efficiency.
- Refer to the MAX17623/MAX17624 evaluation kit layout for first pass success.

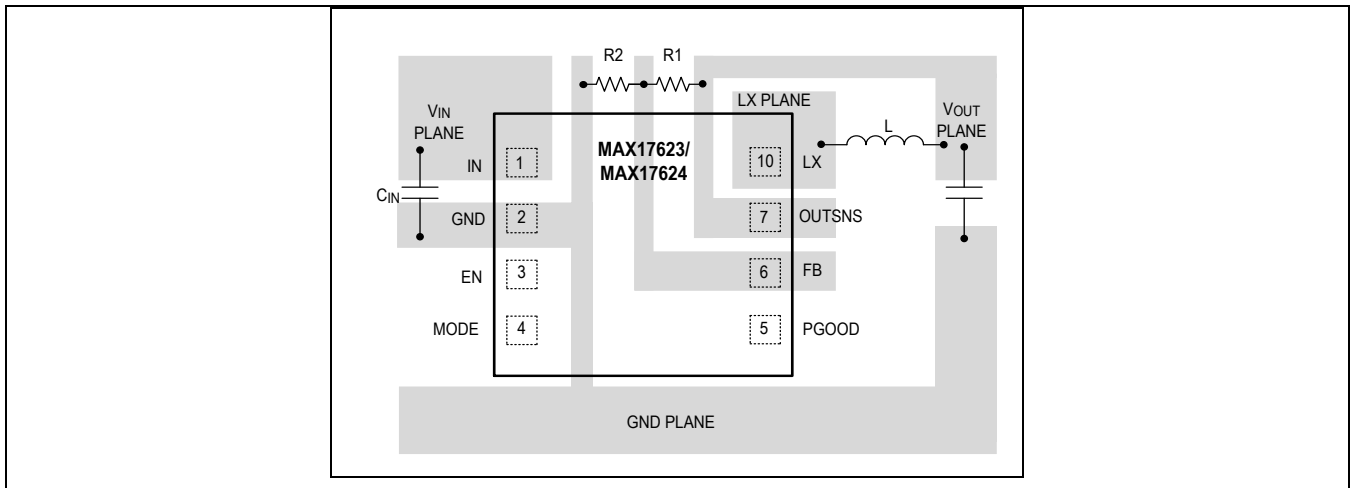

Figure 2. Layout Guidelines

MAX17623
MAX17624

2.9V to 5.5V, 1A, Synchronous Step-Down Converter with Integrated MOSFETs

Typical Application Circuits

Typical Application Circuit (0.8V, 1A)

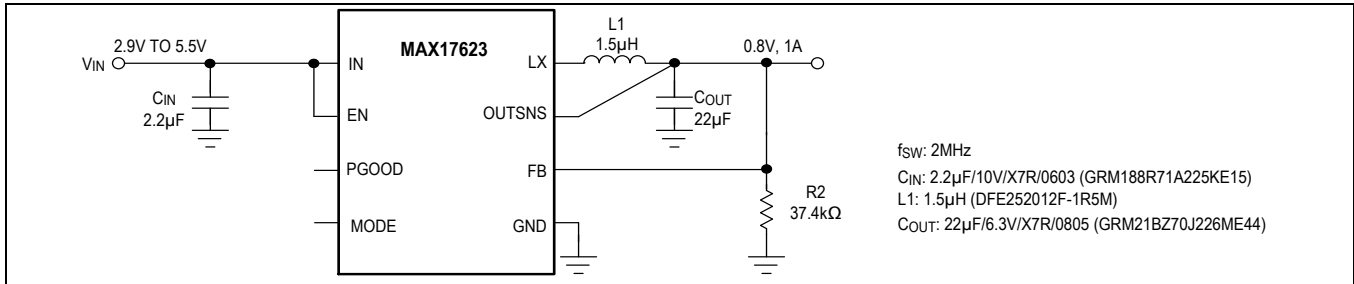

Typical Application Circuit (1.5V, 1A)

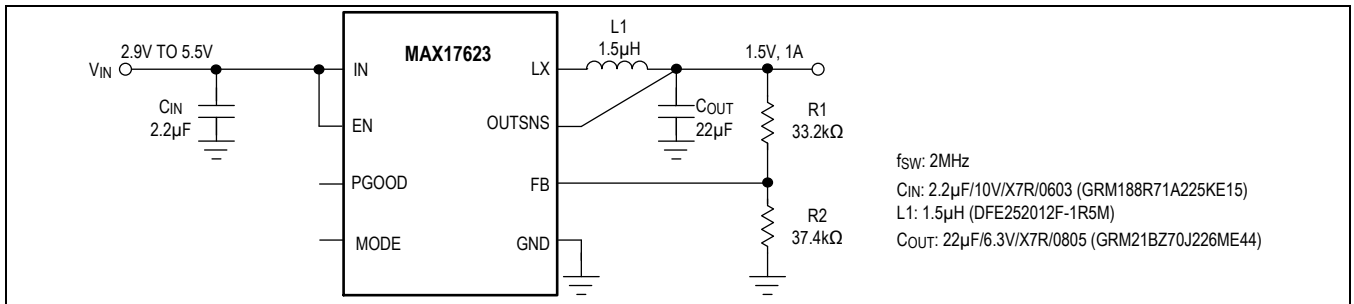

Typical Application Circuit (1.5V, 1A)

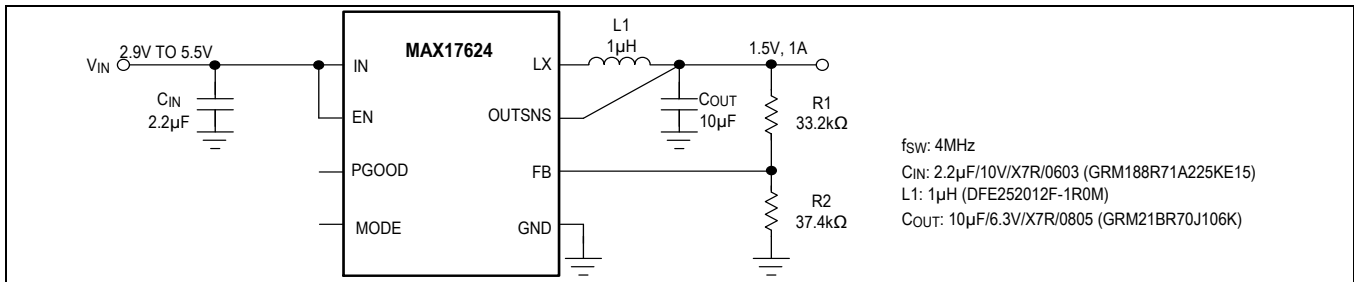

Typical Application Circuit (3.3V, 1A)

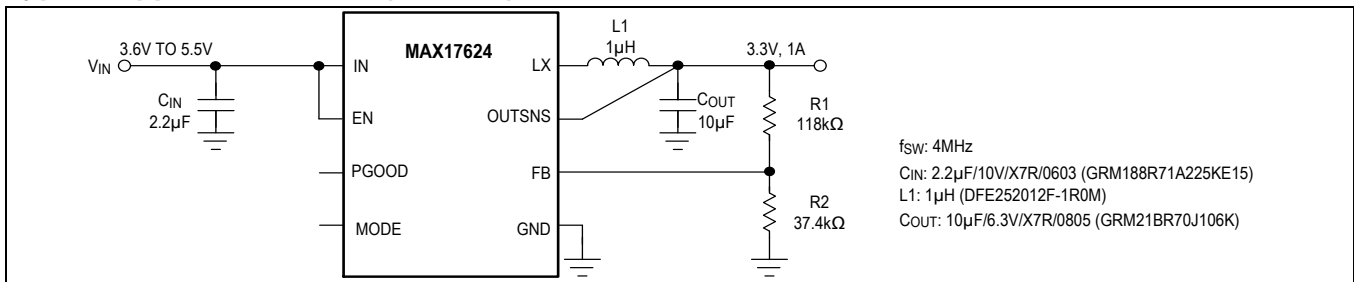

MAX17623
MAX17624

2.9V to 5.5V, 1A, Synchronous Step-Down
Converter with Integrated MOSFETs

Ordering Information

PART NUMBER	TEMP RANGE	PIN-PACKAGE	f _{SW} (MHz)	V _{OUT} (V)
MAX17623 ATA+	-40°C to +125°C	8 TDFN	2	0.8 to 1.5
MAX17623ATA+T	-40°C to +125°C	8 TDFN	2	0.8 to 1.5
MAX17624 ATA+	-40°C to +125°C	8 TDFN	4	1.5 to 3.3
MAX17624ATA+T	-40°C to +125°C	8 TDFN	4	1.5 to 3.3

+ Denotes a lead(Pb)-free/RoHS-compliant package.

T = Tape-and-reel.

MAX17623
MAX17624

2.9V to 5.5V, 1A, Synchronous Step-Down
Converter with Integrated MOSFETs

Revision History

REVISION NUMBER	REVISION DATE	DESCRIPTION	PAGES CHANGED
0	10/20	Initial release	—

For pricing, delivery, and ordering information, please visit Maxim Integrated's online storefront at <https://www.maximintegrated.com/en/storefront/storefront.html>.

Maxim Integrated cannot assume responsibility for use of any circuitry other than circuitry entirely embodied in a Maxim Integrated product. No circuit patent licenses are implied. Maxim Integrated reserves the right to change the circuitry and specifications without notice at any time. The parametric values (min and max limits) shown in the Electrical Characteristics table are guaranteed. Other parametric values quoted in this data sheet are provided for guidance.