

## General Description

The MAX11198 evaluation kit (EV kit) provides a proven design to evaluate the MAX11198 of 16-bit, 2-channel, 2Msps, fully differential simultaneously sampling SAR ADCs with an internal reference. The EV kit includes an evaluation board and a graphical user interface (GUI) that provides communication from the target device to the PC through a ZedBoard™ with a Xilinx Zynq® -7000 SOC. The EV kit is connected to a ZedBoard through a low-pin-count FMC connector and a ZedBoard connected to the PC through an Ethernet port.

The EV kit includes Windows XP®, Windows® 7 and Windows 8 compatible software for exercising the features of the IC. The EV kit GUI allows different sample sizes, adjustable sampling rates, and graphing software that includes the FFT and histogram of the sampled signals.

The EV kit can be powered by +12V supply from ZedBoard or by an external power supply. The EV kit has two DC-DC converters and 5V LDO which provide all necessary supplies for operation with ZedBoard.

The MAX11198 EV kit comes installed with a MAX11198ATE+ in a 16-pin, 2mm x 3mm TQFN-EP package.

The EV kit aims to be used with an external resolver or encoder to monitor and measuring degrees of rotation or absolute position of the rotor at any given moment.

## Features

- 50MHz SPI Clock Capability through FMC Connector
- Various Sample Sizes and Sample Rates
- Collects Up to 1 Million Samples
- Time Domain, Frequency Domain, and Histogram Plotting
- Sync In and Sync Out for Coherent Sampling
- On-Board Input Buffers: MAX44242 and MAX44205 (Fully Differential)
- On-Board External Voltage Reference: MAX6126
- Proven PCB Layout
- Fully Assembled and Tested
- Windows XP, Windows 7, and Windows 8-Compatible Software

Ordering Information appears at end of data sheet.

*Windows and Windows XP are registered trademarks and registered service marks of Microsoft Corporation.*

*ZedBoard is a trademark of Avnet Corp.*

*Zynq is a registered trademark of Xilinx, Inc..*

EV Kit Photo

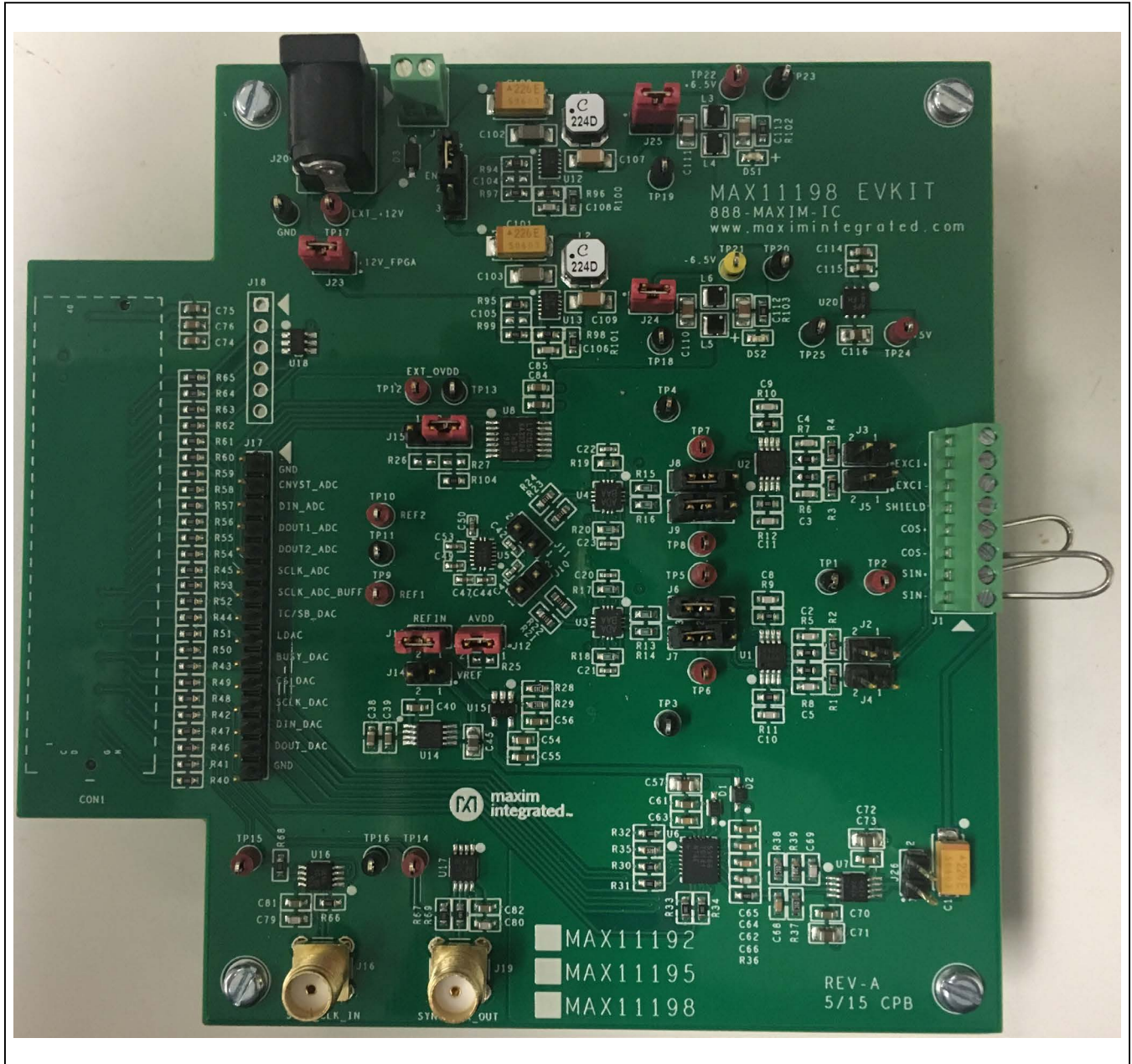

System Block Diagram

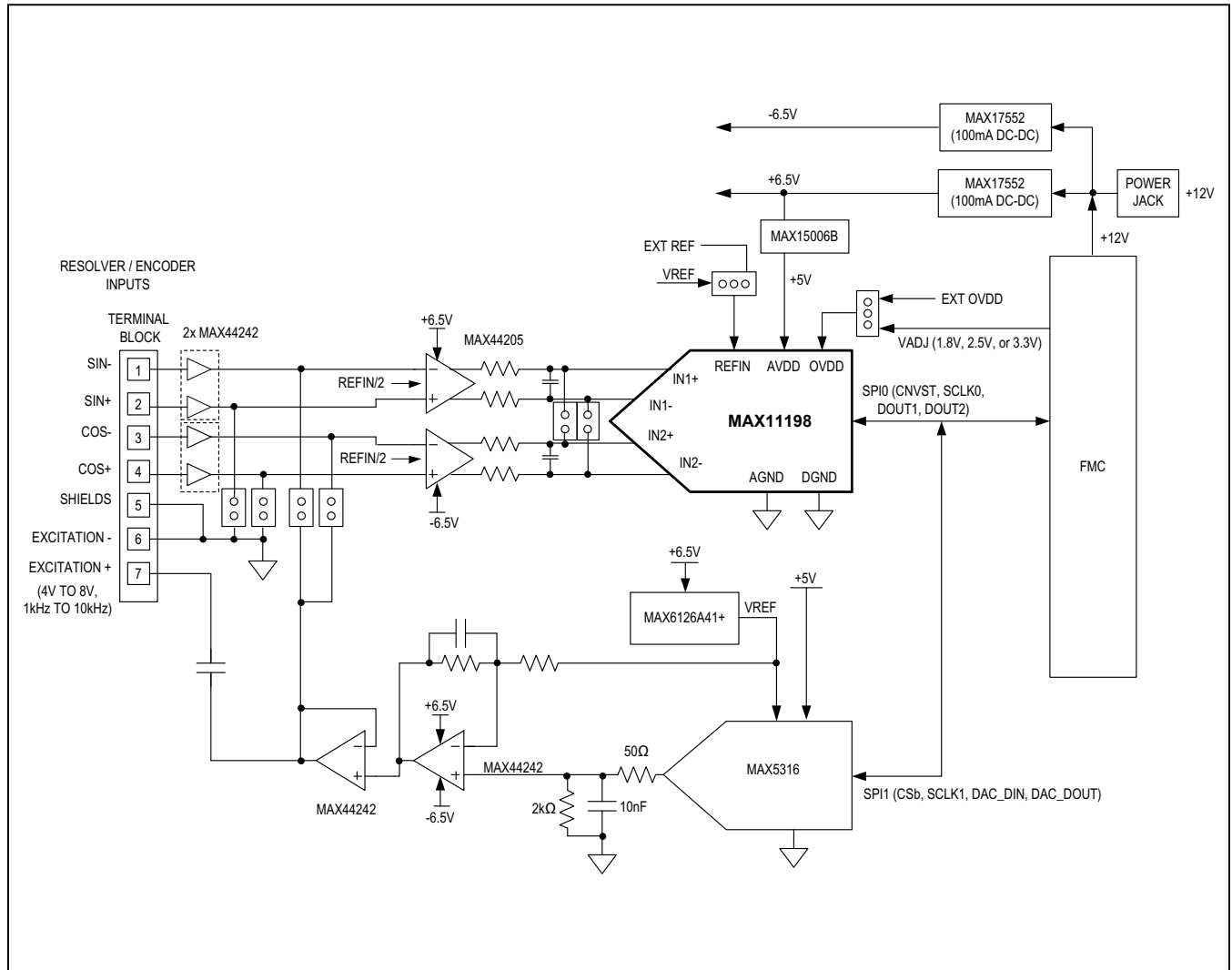

MAX11198 EV Kit Files

FILE	DESCRIPTION
MAX11198EVKitSetupV1.0.exe	Application Program (GUI)
Boot.bin	ZedBoard firmware (SD card to boot Zynq)

**Quick Start**

**Required Equipment**

- MAX11198 EV kit (includes SD card with firmware)
- ZedBoard FPGA platform (optional – **NOT INCLUDED** with EV Kit)
- Function generator or an external resolver (optional)
- Windows XP, Windows 7 or Windows 8 PC with an Ethernet port

**Note:** In the following section(s), software-related items are identified by bolding. Text in **bold** refers to items directly from the EV system software. Text in **bold and under-line** refers to items from the Windows operating system.

**Procedure**

The EV kit is fully assembled and tested. Follow the steps below to verify board operation:

- 1) Visit [www.maximintegrated.com/evkitsoftware](http://www.maximintegrated.com/evkitsoftware) to download the latest version of the EV kit software, MAX11198EVK.ZIP. Save the EV kit software to a temporary folder and uncompress the ZIP file.
- 2) Install the EV kit software on your computer by running the MAX11198\_EVKitSetupV1.0.exe program inside the temporary folder. The program files are copied to your PC and icons are created in the Windows **Start | Programs** menu.
- 3) Connect the Ethernet cable from the PC to the ZedBoard and configure the Internet Protocol Version 4 (TCP/Ipv4) properties in the local area Connection to IP address 192.168.1.2 and subnet Mask to 255.255.255.0.
- 4) Verify that the ZedBoard SD card contains the Boot. bin file for the MAX11198 EV Kit
- 5) Connect the EV Kit FMC connector to the ZedBoard FMC connector. Gently press them together.
- 6) Verify that all jumpers are in their default positions for the ZedBoard ([Table 1](#)) and EV kit board ([Table 2](#)).
- 7) Connect the 12V power supply to the ZedBoard. Leave the Zedboard powered off.
- 8) Enable the ZedBoard power supply by sliding SW8 to ON and connect the +12V adapter to the EV kit.
- 9) Start the EV kit software by opening its icon in the **Start | Programs** menu. The EV kit software appears as shown in [Figure 1](#). From the **Device** menu select **FPGA**. Verify that the lower left status bar indicates the EV Kit hardware is **Connected**. The following configuration is used to verify functionality of simultaneous sampling of the same signal from signal generator applied to both channels.
- 10) Connect the positive terminal of the function generator to the AIN0D+ (TP1) test point on the EV kit. Connect the negative terminal of the function generator to the AIN0D- (TP2) test point on the EV kit.
- 11) Configure the signal source to generate a 100Hz, 1V<sub>p-p</sub> sinusoidal wave with +1V offset.
- 12) Turn on the function generator.
- 13) Click on the **Scope** tab.
- 14) Check the **Remove DC Offset** checkbox to remove the DC component of the sampled data.
- 15) Click the **Capture** button to start the data analysis.
- 16) The EV kit software appears as shown in [Figure 1](#).
- 17) Verify the frequency is approximately 100Hz is displayed on the right. The scope image has buttons in the upper right corner that allow zooming in to detail.

**Table 1. ZedBoard Jumper Settings**

JUMPER	SHUNT POSITION	DESCRIPTION
J18	1-2	Select 3.3V for VADJ (OVDD)
	3-4	Select 2.5V for VADJ (OVDD)
	5-6	Select 1.8V for VADJ (OVDD)
JP11 JP10 JP9 JP8 JP7 JP10	2-3 1-2 1-2 2-3 2-3	Boot from SD card
J12	NA	SD card installed
J20	NA	Connected to 12V wall adapter
SW8	OFF	ZedBoard power switch, OFF while connecting boards

Table 2. MAX11198 Board Jumper Settings

HEADER	JUMPER POSITION	DESCRIPTION
J2	Open*	Use differential input to Channel 1
	1-2	Use single-ended input to Channel 1 referenced to GND
J3	Open*	Use differential input to Channel 2
	1-2	Use single-ended input to Channel 2 referenced to GND
J4	Open*	TP2 is disconnected to Channel 1 input
	1-2	TP2 is connected to Channel 1 input
J5	Open*	TP2 is disconnected to Channel 2 input
	1-2	TP2 is connected to Channel 2 input
J6	1-2*	Use U1.A as input buffer to Channel 1 negative input
	2-3	Bypass U1.A
J7	1-2*	Use U1.B as input buffer to Channel 1 positive input
	2-3	Bypass U1.B
J8	1-2*	Use U2.A as input buffer to Channel 2 negative input
	2-3	Bypass U2.A
J9	1-2*	Use U2.B as input buffer to Channel 2 positive input
	2-3	Bypass U2.B
J10	Open*	For independent Channel 1 and Channel 2 measurements
	1-2	Short IN1+ to IN2+ for single input to both channels
J11	Open*	For independent Channel 1 and Channel 2 measurements
	1-2	Short IN1- to IN2- for single input to both channels
J12	Open	Use J12.2 to supply an external voltage to AVDD
	1-2*	Use onboard +5V to AVDD
J13	Open*	Use an external reference
	1-2*	Generates REFIN/2 for differential buffers (U3, U4)
J14	Open*	Disconnect U14 output from J13 and U15. U15 uses U5 internal reference to generate REFIN/2 for U3 and U4 differential buffers.
	1-2*	Connect U14 to J13 and U15. U15 generates REFIN/2 = 2.048V for U3 and U4 differential buffers.
J15	1-2	Use external OVDD
	2-3*	Use OVDD voltage from ZedBoard. See J18 selection in Table 1.
J22	1-2*	Enable U12 and U13 DC-DC converters to generate $\pm 6.5V$
	2-3	Disable U12 and U13; it is also recommended to open J24 and J25
J23	1-2*	Use +12V from ZedBoard to power EV kit
	Open	Use an external +12V supply to J20 or J21
J24	1-2*	Use -6.5V from U13
	Open	Use an external -6.5V to TP21
J25	1-2*	Use +6.5V from U12
	Open	Use an external +6.5V to TP22
J26	Open*	Disconnect U7 output from TP2
	1-2	Connect U7 output to TP2

\*Default position.

### General Description of Software

The main window of the EV kit software contains five tabs: **System**, **Scope**, **DMM**, **Histogram**, and **FFT**. The **System** tab provides control for the ADC configuration including calibration and single data capture. The other four tabs are used for evaluating the data captured by the ADC.

### System Tab

The **System** tab allows to select **Sample Rate**, **Number of Samples**, **Clock Source** for coherent sampling and for SPI interface, as well as EV kit **Device** resolution from

corresponding pulldown menu. There is a block diagram of the EV kit and Calibration section for convenience.

The **Read Data** information is displayed on the right, which shows the data in both voltage and LSB, see [Figure 1](#).

### Sample Rate (SPS)

To select the desired data rate choose the **Sample Rate (SPS)** pulldown menu. The sampling rate is available from 1000sps to 2000000sps.

### Number of Samples

The Number of Samples pulldown menu allows choosing from 1 up to 1048576 samples to be captured.

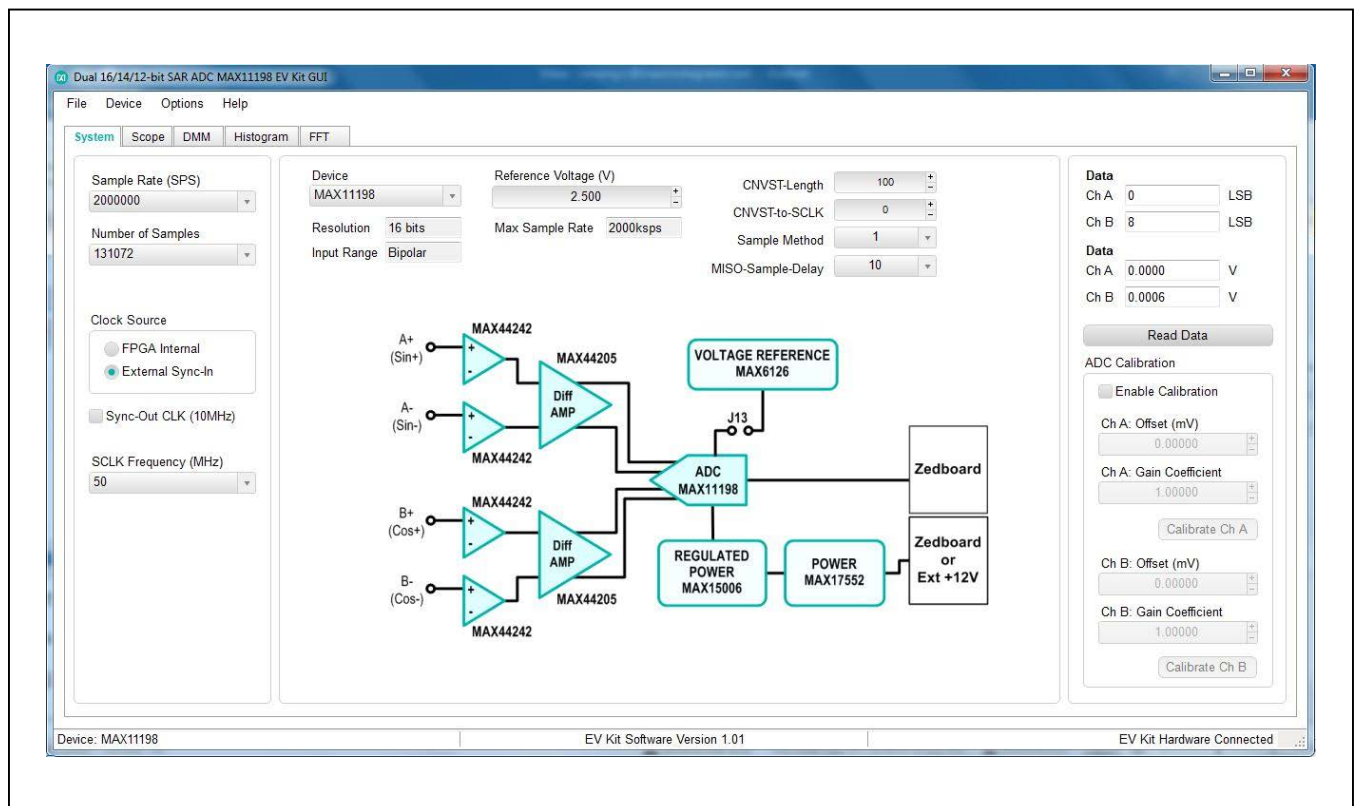

Figure 1. EV Kit Software (Configuration Tab)

### Reference Voltage

The Reference Voltage selection should match with the jumper settings refer to [Table 2](#). A user can select either internal or external reference voltage. The internal reference is fixed to 2.5V. The external reference can be from 2.5V to 4.75V. Use “+” or “-” buttons to adjust the actual voltage reference, or simply type in a new value.

### ADC Calibration

The ADC Calibration section allows to calibrate each channel independently.

### Scope Tab

The **Scope** tab sheet is used to capture data and display it in the time domain. The desired **Sampling Rate, Number**

**of Samples, Display Unit, Average Samples, and Resolution Selection** can be set in this tab if they were not appropriately adjusted in other tabs. The **Display Unit** pull-down list allows counts in LSB and voltages in V, mV, or  $\mu$ V. Once the desired configuration is set, click on the **Capture** button. The right side of the tab sheet displays details of the waveform, such as average, standard deviation, maximum, minimum, and fundamental frequency for each channel as shown in [Figure 2](#).

To save the captured data to a file, select **Options > Save Graph > Scope**. This saves the setting on the left and the data captured to a CSV file.

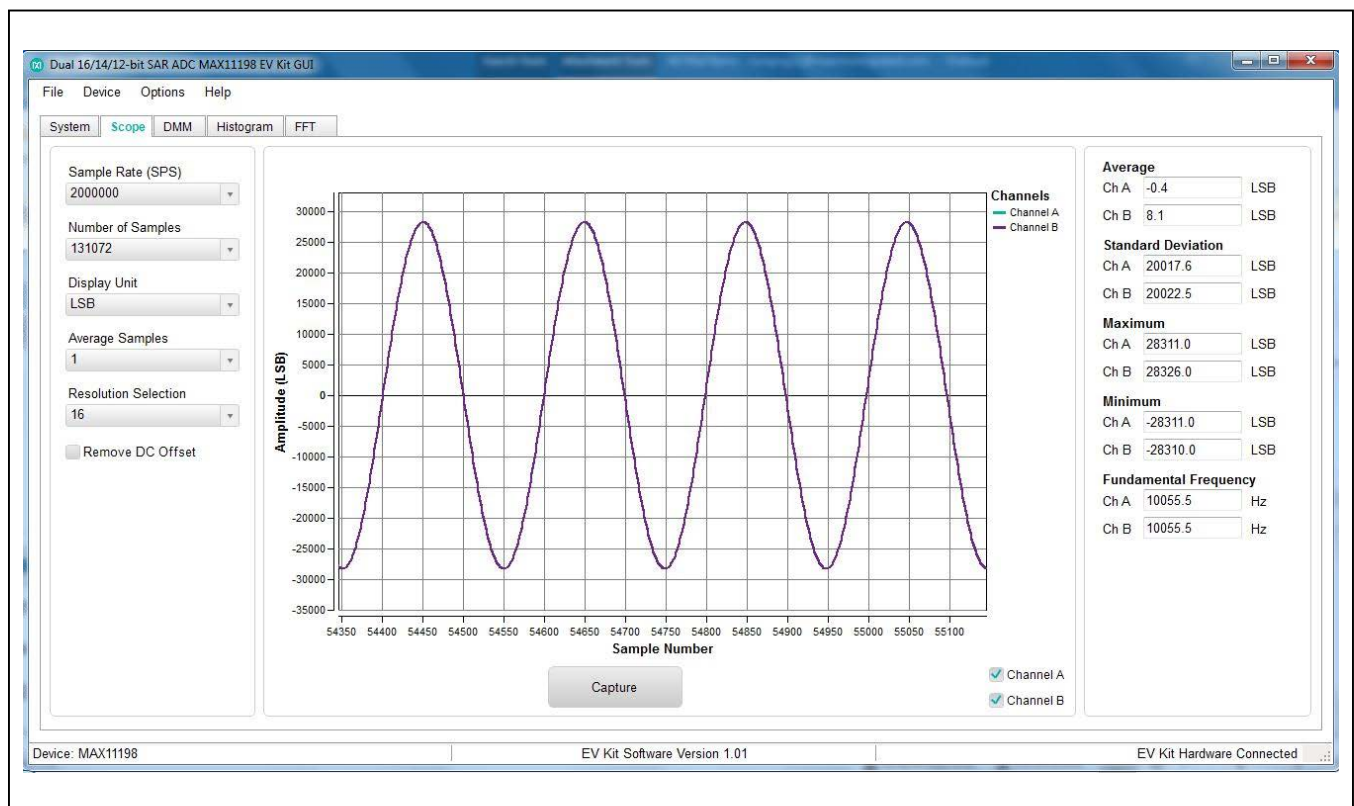

Figure 2. EV Kit Software (ScopeTab)

**DMM Tab**

The DMM tab sheet provides the typical information as a digital multimeter. Once the desired configuration is set, click on the **Capture** button. [Figure 3](#) displays the results shown by the **DMM** tab when no signal is applied to both channels.

**Histogram Tab**

The **Histogram** tab sheet is used to show the histogram of the data. Sampling rate and number of samples can also be set in this tab if they were not appropriately adjusted in other tabs. Once the desired configuration is set, click on the **Capture** button. The right side of the tab sheet displays details of the histogram such as average, standard deviation, maximum, minimum, peak-to-peak noise, effective resolution, and noise-free resolution as shown in [Figure 4](#).

The histogram tab is enabled by default. Using the histogram will slow down the GUI response. To disable it, check the **Disable Histogram** box.

To save the histogram data to a file, go to **Options > Save Graph > Histogram**. This saves the setting on the left and the histogram data captured to a CSV file.

**FFT Tab**

The **FFT** tab sheet is used to display the FFT of the data. The **Sample Rate**, **Number of Samples**, **Resolution Selection**, and type **Window Function** can be set as desired. To calculate the **Adjusted Input Signal** frequency for **Coherent Sampling**, type in the **Input Signal** frequency in Hertz and GUI automatically calculates the master clock needs to be applied for coherent sampling and vice versa. Once the preferred configuration is set, click on the **Capture** button. The right side of the tab displays the performance based on the FFT, such as fundamental frequency, SNR, SINAD, THD, SFDR, ENOB, and Noise Floor as shown in [Figure 5](#).

To save the FFT data to a file, go to **Options > Save Graph > FFT**. This saves the setting on the left and the FFT data captured to a CSV file.

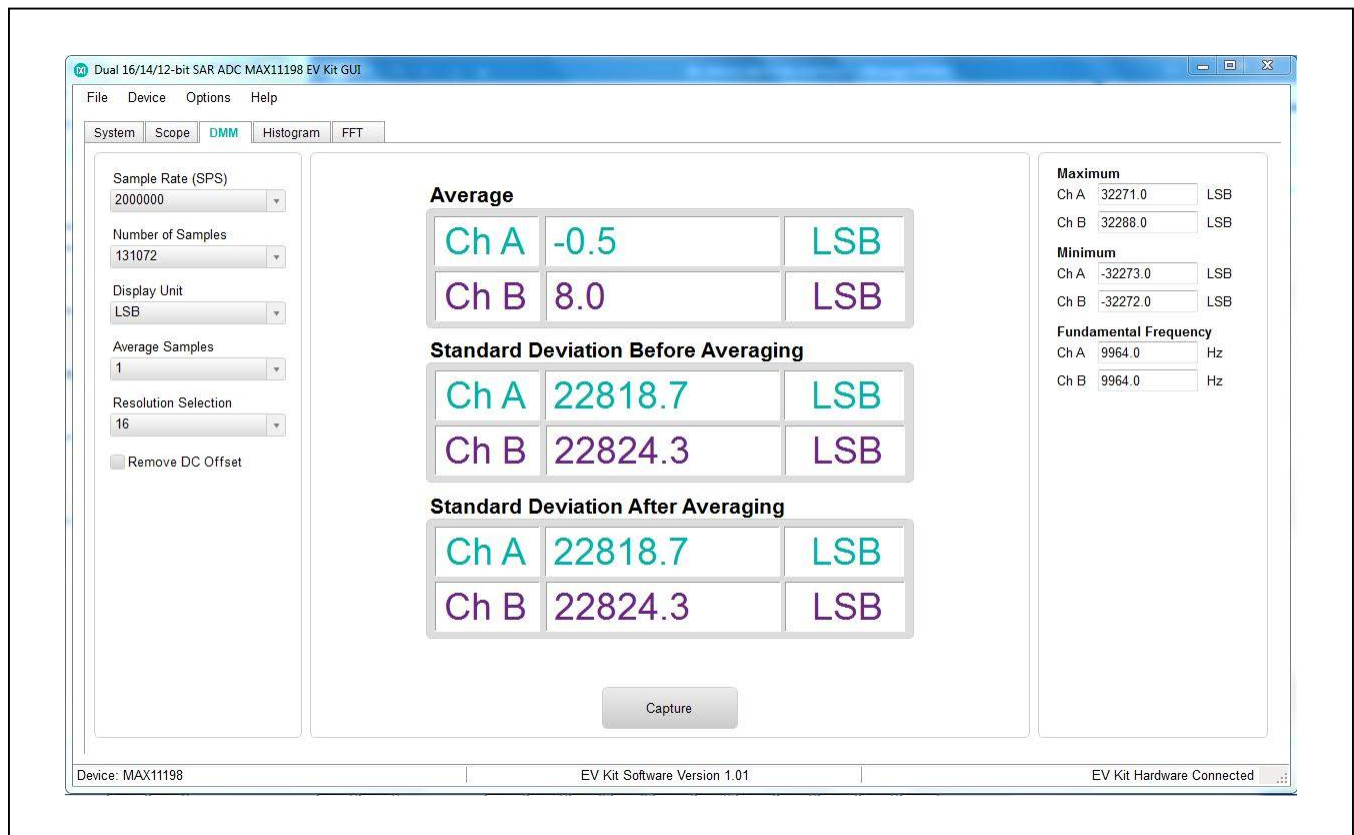

Figure 3. EV Kit Software (DMM Tab)



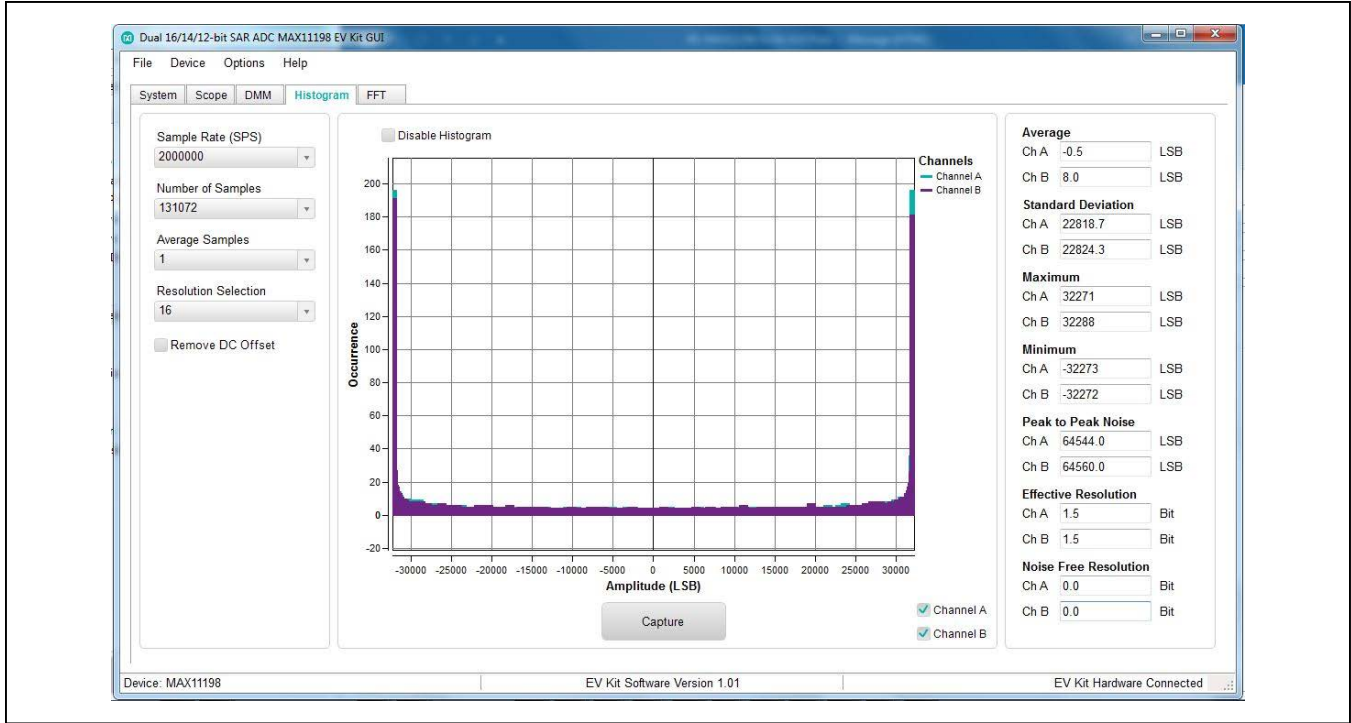

Figure 4. EV Kit Software (Histogram Tab)

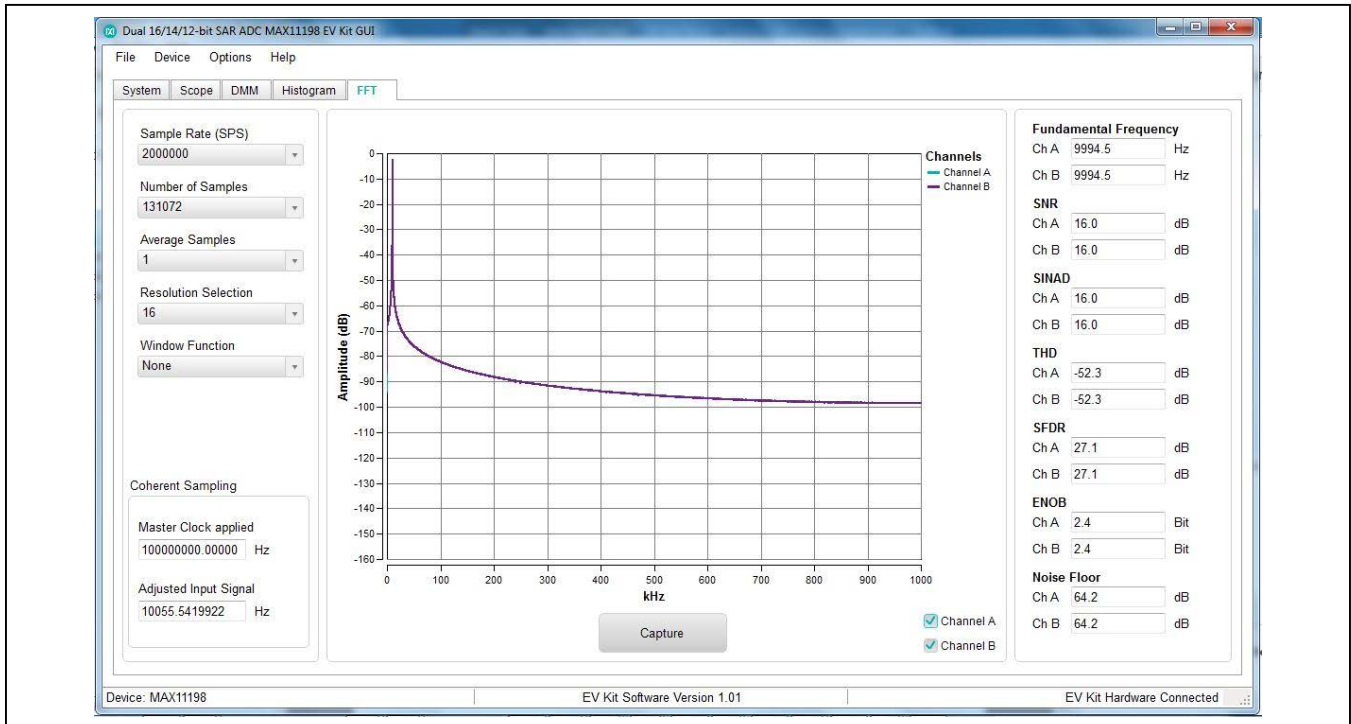

Figure 5. EV Kit Software (FFT Tab)

When coherent sampling is needed, this tab allows the user to calculate the input signal applied to the board. Adjust the input frequency of the low-jitter clock to the value as shown in the **Adjusted Input Signal (Hz)** and apply it to the EV KIT SYNC\_CLK\_IN connector. See the *Sync Input and Sync Output* section before using this feature.

Figure 6 shows the setup Maxim Integrated uses to capture data for coherent sampling.

Figure 7 shows the coherent FFT signal. Use the jumper settings from Table 2 for proper configurations. The low-jitter clock is synchronized with the signal generator at 10MHz from the ZedBoard. To achieve coherent sampling, click on the **Calculate** button and enter the **Adjusted Input Signal (Hz)** into low-jitter clock. Timing for all SPI timing and sampling rate are based off the system clock.

**User-Supplied SPI**

To evaluate the EV kit with a user-supplied SPI bus, disconnect the board from the ZedBoard. Apply the user-supplied SPI signals to SCLK, CNVST, DOUT1, and DOUT2 to J17. Make sure the return ground from J17.15 is connected to master ground.

**FMC Interface**

The users should confirm compatibility of pin-usage between their own FMC implementation and that of the MAXIM EV kit before connecting the MAXIM EV kit to a different system with FMC connectors.

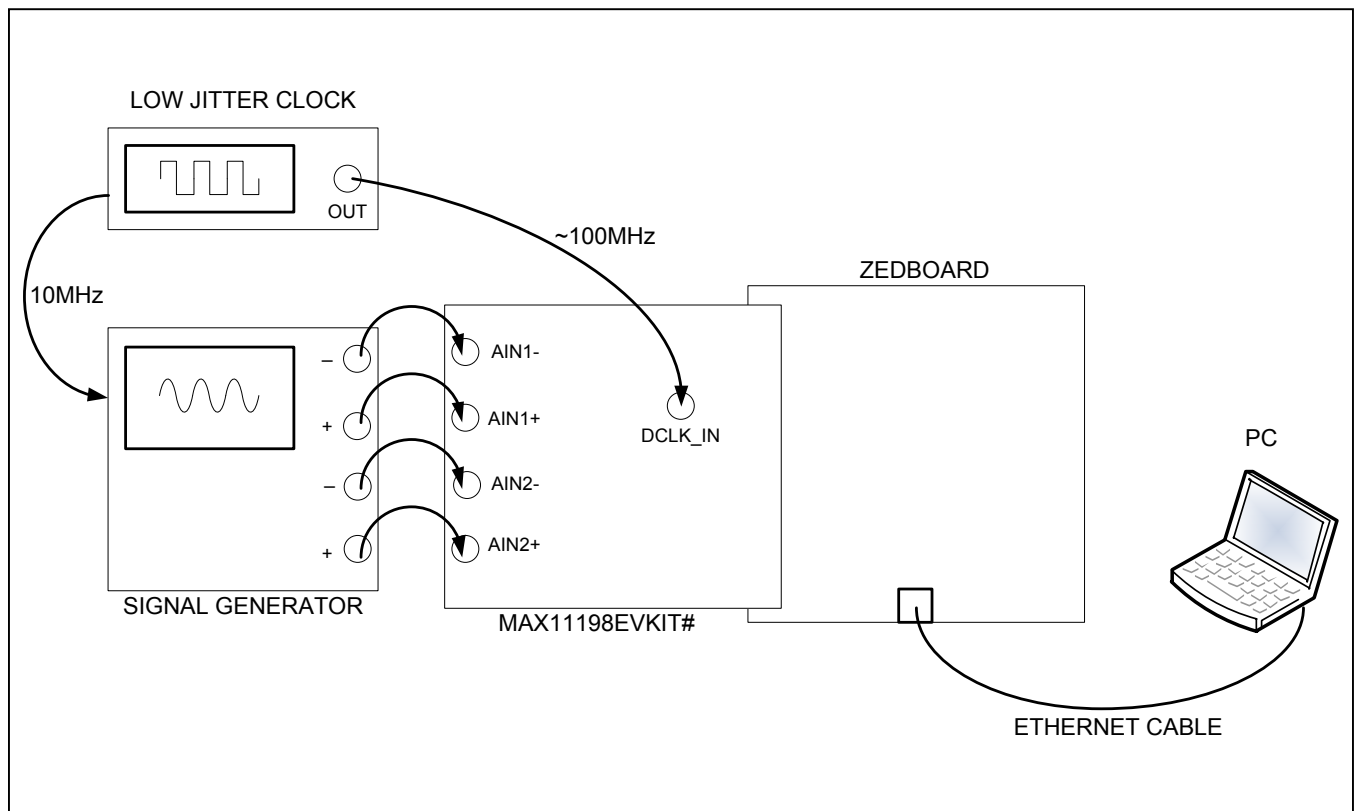

Figure 6. EV Kit Coherent Sampling Setup

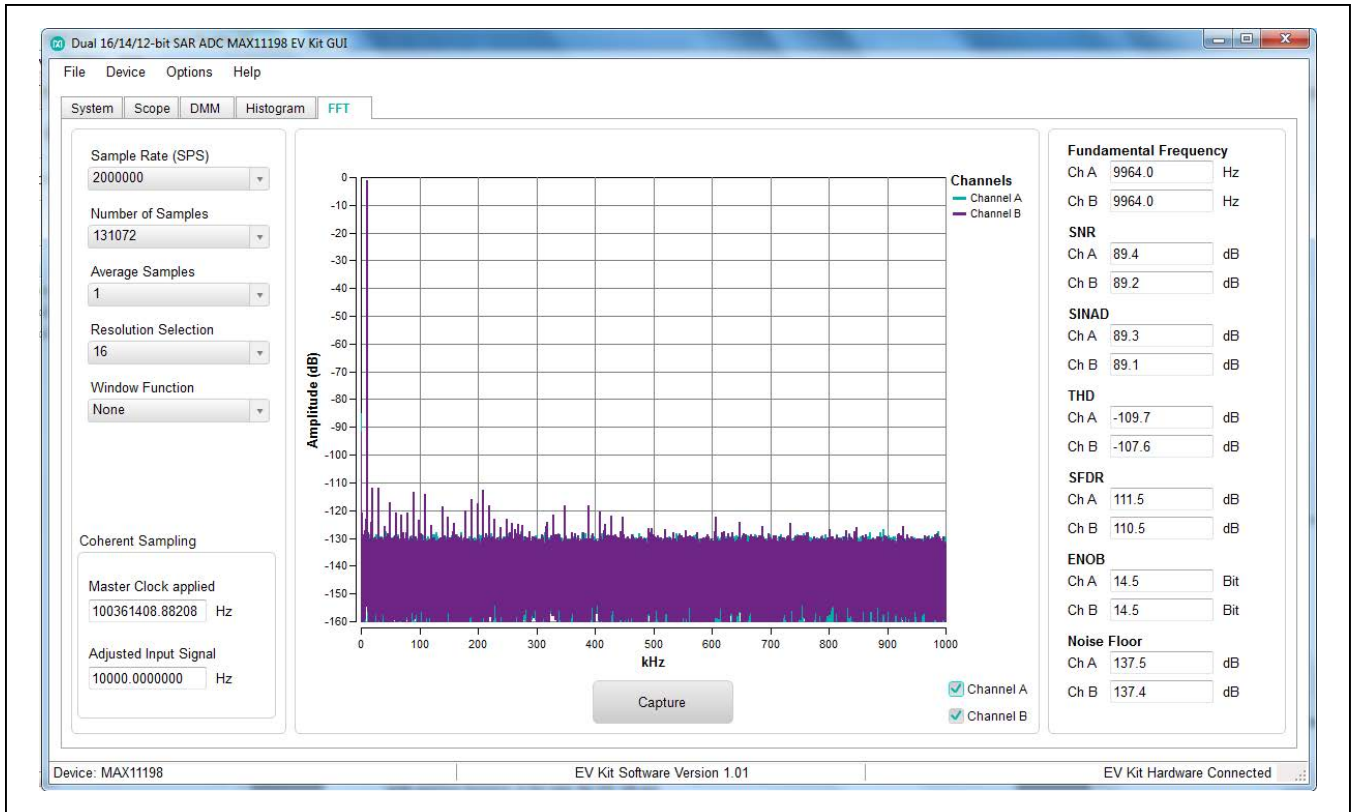

Figure 7. MAX11198 EV Kit Coherent Sampling (FFT Tab)

### External OVDD Power Supply

An external OVDD voltage can supply to TP12 in range from 1.8V to 3.6V. The J15 shunt should be set in 1-2 position.

### User-Supplied Power Supply

The EV kit receives power from ZedBoard or from a single DC source of 12V, 200mA through a J26 power jack. The two MAX17552 DC-DC converters generate +6.5V and -6.5V for the buffers, U1 and U2, and differential amplifiers, U3 and U4. The +6.5V power is then regulated down to a +5V by MAX15006B for U5. See the EV kit schematic for details. User can supply an external +6.5V to TP22 and -6.5V to TP21 to reduce the influence of DC-DC converter switching frequency. In this case, the J23, J24 and J25 shunts must be removed.

### ADC Input Amplifiers

The analog front-end conditioner for each channel includes the input low-pass filter (1k resistor and 1000pF capacitor), the MAX44242 input buffer and the MAX44205 fully differential amplifier.

### Sync Input and Sync Output (for coherent sampling)

Sync Input and Sync Output is applicable to the FPGA (ZedBoard) and is not used in Standalone mode. Sync Input and Sync Output The SYNC\_IN SMA accepts an approximate 100MHz waveform signal to generate the system clock of the ZedBoard. For maximum performance, use a low-jitter clock that syncs to the user's analog function generator. The SYNC\_OUT SMA outputs a 10MHz square waveform that syncs to the user's analog function generator. Both options are used for coherent sampling of the IC. Use only one option at a time. The relationship between  $f_{IN}$ ,  $f_S$ ,  $N_{CYCLES}$ , and  $M_{SAMPLES}$  is given as follows:

$$\frac{f_{IN}}{f_S} = \frac{N_{CYCLES}}{M_{SAMPLES}}$$

where:

$f_{IN}$  = Input frequency

$f_S$  = Sampling frequency

$N_{CYCLES}$  = Prime number of cycles in the sampled set

$M_{SAMPLES}$  = Total number of samples

## MAX11198 EV Kit Bill of Materials

ITEM	REF DES	DNI/DNP	QTY	MFG PART #	MFG	VALUE	DESCRIPTION	NOTES
1	C1, C100, C101	-	3	TPSC226K025R0275	AVX	22UF	CAPACITOR; SMT; 6032; TANTALUM; 22uF; 25V; 10%; TPS; -55degC to +125degC	
2	C2-C5, C8-C11	-	8	GRM1885C1H102JA01; C1608C0G1H102J080	MURATA; TDK	1000PF	CAPACITOR; SMT (0603); CERAMIC CHIP; 1000PF; 50V; TOL=5%; TG=-55 DEGC TO +125 DEGC	
3	C6, C7, C14, C15, C31, C35, C57, C67, C116	-	9	GRM21BR61E106K; C2012X5R1E106K125AB; C2012X5R1E106K	MURATA/TKD	10UF	CAPACITOR; SMT (0805); CERAMIC CHIP; 10UF; 25V; TOL=10%; MODEL=; TG=-55 DEGC TO +125 DEGC; TC=X5R	
4	C12, C13, C16-C19, C28, C29, C32, C33, C36, C37, C39, C40, C55, C56, C61, C65, C70, C73, C78, C81, C82, C84, C115	-	25	GRM188R72A104KA35; CC0603KRX7R0BB104	MURATA; TDK	0.1UF	CAPACITOR; SMT (0603); CERAMIC CHIP; 0.1UF; 100V; TOL=10%; TG=-55 DEGC TO +125 DEGC; TC=X7R	
5	C20-C23	-	4	GRM1555C1H102JA01; C1005C0G1H102J050	MURATA; TDK	1000PF	CAPACITOR; SMT (0402); CERAMIC CHIP; 1000PF; 50V; TOL=5%; TG=-55 DEGC TO +125 DEGC	
6	C30, C34	-	2	TMK212BBJ106KG-T; CL21A106KAFN3N	TAIYO YUDEN	10UF	CAPACITOR; SMT (0805); CERAMIC CHIP; 10UF; 25V; TOL=10%; MODEL=; TG=-55 DEGC TO +85 DEGC; TC=X5R	
7	C38, C54, C74-C77, C85, C114	-	8	UMK107AB7105KA	TAIYO YUDEN	1UF	CAPACITOR; SMT (0603); CERAMIC CHIP; 1UF; 50V; TOL=10%; TG=-55 DEGC TO +125 DEGC; TC=X7R	
8	C41, C42	-	2	C0402H102J5GAC	KEMET	1000PF	CAPACITOR; SMT (0402); CERAMIC CHIP; 1000PF; 50V; TOL=5%; MODEL=HT SERIES; TG=-55 DEGC TO +200 DEGC; TC=C0G	
9	C43, C46, C48, C51, C52	-	5	C1608X5R1E106M080AC; CL10A106MA8NRNC	TDK/SAMSUNG ELECTRONICS	10UF	CAPACITOR; SMT (0603); CERAMIC CHIP; 10UF; 25V; TOL=20%; TG=-55 DEGC TO +85 DEGC; TC=X5R	
10	C44, C47, C49, C50, C53	-	5	CGA2B3X7R1H104K; C1005X7R1H104K050BB; GRM155R71H104KE14	TDK; MURATA	0.1UF	CAPACITOR; SMT (0402); CERAMIC CHIP; 0.1UF; 50V; TOL=10%; TG=-55 DEGC TO +125 DEGC; TC=X7R	
11	C45, C58, C59, C71, C72	-	5	GMK212B7105KG	TAIYO YUDEN	1.0UF	CAPACITOR; SMT (0805); CERAMIC; 1UF; 35V; TOL=10%; MODEL=GMK SERIES; TG=-55 DEGC TO +125 DEGC; TC=X7R	

MAX11198 EV Kit Bill of Materials (continued)

ITEM	REF DES	DNI/DNP	QTY	MFG PART #	MFG	VALUE	DESCRIPTION	NOTES
12	C62-C64, C68	-	4	C0603X7R500103JNP; C0603C103J5	KEMET	0.01UF	CAPACITOR; SMT (0603); CERAMIC CHIP; 0.01UF; 50V; TOL=5%; MODEL=X7R; TG=-55 DEGC TO +125 DEGC; TC=+/-	
13	C66	-	1	C0603C101J5GAC; ECJ- 1VC1H101J; C1608C0G1H101J080AA; GRM1885C1H101JA01	KEMET/PANASONI C/TDK/MURATA	100PF	CAPACITOR; SMT (0603); CERAMIC CHIP; 100PF; 50V; TOL=5%; MODEL=C0G; TG=-55 DEGC TO +125 DEGC; TC=COG	
14	C69, C79, C80, C106, C108	-	5	C0603C102K1GAC	KEMET	1000PF	CAPACITOR; SMT (0603); CERAMIC CHIP; 1000PF; 100V; TOL=10%; MODEL=C0G; TG=- 55 DEGC TO +125 DEGC; TC=+/-	
15	C102, C103	-	2	C1206C105K3RAC; ECJ- 3YB1E105K	KEMET/PANASONI C	1UF	CAPACITOR; SMT (1206); CERAMIC CHIP; 1UF; 25V; TOL=10%; MODEL=X7R; TG=-55 DEGC TO +125 DEGC; TC=+/-	
16	C107, C109	-	2	GRM31CR71E106KA12L; CL31B106KAHNNN	MURATA; SAMSUNG ELECTRONICS	10UF	CAPACITOR; SMT (1206); CERAMIC CHIP; 10UF; 25V; TOL=10%; TG=-55 DEGC TO +125 DEGC; TC=X7R	
17	C110-C113	-	4	C2012X7R1E475K125AB	TDK	4.7UF	CAPACITOR; SMT (0805); CERAMIC CHIP; 4.7UF; 25V; TOL=10%; MODEL=-55 DEGC TO +125 DEGC; TC=X7R	
18	CON1	-	1	ASP-134604-01	SAMTEC	ASP- 134604-01	CONNECTOR; MALE; SMT; HIGH SPEED/HIGH DENSITY OPEN PIN FIELD TERMINAL ARRAY; STRAIGHT; 160PINS	
19	D1	-	1	MMSZ5226BS	DIODES INCORPORATED	3.3V	DIODE; ZNR; SMT (SOD-323); Vz=3.3V; Izm=0.01A	
20	D2	-	1	B0530WS-7-F	DIODES INCORPORATED	B0530WS- 7-F	DIODE; SCH; SMT (SOD-323); PIV=30V; IF=0.5A	
21	D3	-	1	MBR0520L	FAIRCHILD SEMICONDUCTOR	MBR0520 L	DIODE, SCHOTTKY, SOD-123, PIV=20V, Vf=0.385V@If=0.5A, If(ave)=0.5A	
22	DS1, DS2	-	2	LGL29K-G2J1-24-Z	OSRAM	LGL29K- G2J1-24-Z	DIODE; LED; SMARTLED; GREEN; SMT; PIV=1.7V; IF=0.02A	
23	GND, TP1, TP3, TP4, TP11, TP13, TP16, TP18- TP20, TP23, TP25	-	12	5001	KEYSTONE	N/A	TEST POINT; PIN DIA=0.1IN; TOTAL LENGTH=0.3IN; BOARD HOLE=0.04IN; BLACK; PHOSPHOR BRONZE WIRE SILVER PLATE FINISH;	
24	J1	-	1	OSTVN08A150	ON-SHORE TECHNOLOGY INC.	OSTVN08 A150	CONNECTOR; FEMALE; THROUGH HOLE; SCREW TYPE; GREEN TERMINAL BLOCK; RIGHT ANGLE; 8PINS	
25	J2-J5, J10-J14, J23-J26	-	13	PCC02SAAN	SULLINS	PCC02SA AN	CONNECTOR; MALE; THROUGH HOLE; BREAKAWAY; STRAIGHT THROUGH; 2PINS; 65 DEGC TO +125 DEGC	
26	J6-J9, J15, J22	-	6	PCC03SAAN	SULLINS	PCC03SA AN	CONNECTOR; MALE; THROUGH HOLE; BREAKAWAY; STRAIGHT THROUGH; 3PINS; 65 DEGC TO +125 DEGC	

MAX11198 EV Kit Bill of Materials (continued)

ITEM	REF DES	DNI/DNP	QTY	MFG PART #	MFG	VALUE	DESCRIPTION	NOTES
27	J16, J19	-	2	5-1814832-1	TYCO	5-1814832-1	CONNECTOR; FEMALE; THROUGH HOLE; CONN SOCKET SMA STR DIE CAST PCB; STRAIGHT; 5PINS	
28	J17	-	1	PBC15SAAN	SULLINS ELECTRONICS CORP.	PBC15SAAN	CONNECTOR; MALE; THROUGH HOLE; BREAKAWAY; STRAIGHT; 15PINS; -65 DEGC TO +125 DEGC	
29	J20	-	1	KLDX-0202-B	KYCON	KLDX-0202-B	CONNECTOR; FEMALE; THROUGH HOLE; DC POWER JACK; RIGHT ANGLE; 3PINS	
30	J21	-	1	282834-2	TE CONNECTIVITY	282834-2	CONNECTOR; FEMALE; THROUGH HOLE; 2.54MM PITCH; SIDE WIRE ENTRY STACKING TERMINAL BLOCK ; STRAIGHT; 2PINS; -40 DEGC TO + 105 DEGC	
31	L1, L2	-	2	LPS5030-224ML	COILCRAFT	220UH	INDUCTOR; MAGNETICALLY SHIELDED FERRITE BOBBIN CORE; SMT; 220UH; TOL=+/-20%; 0.5A; -40 DEGC TO +85 DEGC	
32	L3-L6	-	4	XPL2010-333ML	COILCRAFT	33UH	INDUCTOR; SMT; MAGNETICALLY SHIELDED FERRITE BOBBIN CORE; 33UH; TOL=+/-20%; 0.38A	
33	R1-R4	-	4	CRCW06031M00JN	VISHAY DALE	1M	RESISTOR; 0603; 1M OHM; 5%; 200PPM; 0.10W; METAL FILM	
34	R5-R8	-	4	CRCW06031001FK; ERJ-3EKF1001V	VISHAY DALE; PANASONIC	1K	RESISTOR; 0603; 1K; 1%; 100PPM; 0.10W; THICK FILM	
35	R9-R12	-	4	CRCW0603100RFK; ERJ-3EKF1000	VISHAY DALE/PANASONIC	100	RESISTOR; 0603; 100 OHM; 1%; 100PPM; 0.10W; THICK FILM	
36	R13-R20	-	8	TNPW06031K00BE; RG1608P-102-B-T5	VISHAY DALE/SUSUMU CO LTD.	1K	RESISTOR; 0603; 1K OHM; 0.1%; 25PPM; 0.10W; THICK FILM	0.10%
37	R21-R24	-	4	RN73C1J10RBTG; 1614350-2	TE CONNECTIVITY	10	RESISTOR; 0603; 10 OHM; 0.1%; 10PPM; 0.063W; THICK FILM	0.10%
38	R28, R29, R37	-	3	TNPW060310K0BE; RN731JTTD1002B	VISHAY DALE/KOA SPEER ELECTRONICS	10K	RESISTOR; 0603; 10K OHM; 0.1%; 25PPM; 0.1W; THICK FILM	
39	R30-R34, R102, R103	-	7	CRCW060310K0FK; 9C06031A1002FK; ERJ-3EKF1002	VISHAY DALE/YAGEO PHICOMP/PANASONIC	10K	RESISTOR; 0603; 10K; 1%; 100PPM; 0.10W; THICK FILM	
40	R35	-	1	CRCW06032K10FK	VISHAY DALE	2.1K	RESISTOR; 0603; 2.1K; 1%; 100PPM; 0.10W; THICK FILM	
41	R36, R66, R69	-	3	CRCW060349R9FK	VISHAY DALE	49.9	RESISTOR; 0603; 49.9 OHM; 1%; 100PPM; 0.10W; THICK FILM	

## MAX11198 EV Kit Bill of Materials (continued)

ITEM	REF DES	DNI/DNP	QTY	MFG PART #	MFG	VALUE	DESCRIPTION	NOTES
42	R38, R39	-	2	TNPW060310K0BE; RN731JTDD1002B	VISHAY DALE/KOA SPEER ELECTRONICS	10K	RESISTOR; 0603; 10K OHM; 0.1%; 25PPM; 0.1W; THICK FILM	0.10%
43	R40-R65	-	26	ERJ-3EKF28R0V	PANASONIC	28	RESISTOR; 0603; 28 OHM; 1%; 100PPM; 0.10W; THICK FILM	
44	R67, R68, R104	-	3	CRCW06030000ZS; MCR03EZPJ000; ERJ- 3GEY0R00	VISHAY DALE/ROHM/PANA SONIC	0	RESISTOR; 0603; 0 OHM; 0%; JUMPER; 0.10W; THICK FILM	
45	R94, R95	-	2	CRCW0603191KFK	VISHAY DALE	191K	RESISTOR; 0603; 191K OHM; 1%; 100PPM; 0.10W; METAL FILM	
46	R96, R98	-	2	ERJ-3EKF3573	PANASONIC	357K	RESISTOR; 0603; 357K OHM; 1%; 100PPM; 0.1W; THICK FILM	
47	R97, R99	-	2	CRCW060349K9FK; ERJ- 3EKF4992V	VISHAY DALE/PANASONIC	49.9K	RESISTOR; 0603; 49.9K OHM; 1%; 100PPM; 0.10W; THICK FILM	
48	R100, R101	-	2	CRCW06031003FK; ERJ- 3EKF1003	VISHAY DALE/PANASONIC	100K	RESISTOR; 0603; 100K; 1%; 100PPM; 0.10W; THICK FILM	
49	TP2, TP5-TP10, TP12, TP14, TP15, TP17, TP22, TP24	-	13	5000	KEYSTONE	N/A	TEST POINT; PIN DIA=0.1IN; TOTAL LENGTH=0.3IN; BOARD HOLE=0.04IN; RED; PHOSPHOR BRONZE WIRE SILVER PLATE FINISH;	
50	TP21	-	1	5004	KEYSTONE	N/A	TEST POINT; PIN DIA=0.1IN; TOTAL LENGTH=0.3IN; BOARD HOLE=0.04IN; YELLOW; PHOSPHOR BRONZE WIRE SILVER PLATE FINISH;	
51	U1, U2, U7	-	3	MAX44242AUA+	MAXIM	MAX4424 2AUA+	IC; OPAMP; DUAL OPERATIONAL AMPLIFIER; UMAX8	
52	U3, U4	-	2	MAX44205	MAXIM	MAX4420 5	IC; LOW-POWER; LOW-DISTORTION; FULLY DIFFERENTIAL OPERATIONAL AMPLIFIER; OZ02; PKG. CODE: T1233-4;	
53	U5	-	1	MAX11198	MAXIM	MAX1119 8	EVKIT PART-IC; ADC; 16-BIT; 2MSPS; DUAL SIMULTANEOUS SAMPLING SAR ADCS WITH INTERNAL REFERENCE; 16L TQFN 2X3 LEAD PITCH 0.5MM	
54	U6	-	1	MAX5316GTG+	MAXIM	MAX5316 GTG+	IC; DAC; 16-BIT; +/-1 LSB ACCURACY VOLTAGE OUTPUT DAC WITH SPI INTERFACE; TQFN24-EP	
55	U8	-	1	74LVC125APW	NXP	74LVC125 APW	IC; BUF; QUAD BUFFER/LINE DRIVER WITH 5V TOLERANT INPUT/OUTPUT; 3-STATE; TSSOP14	

MAX11198 EV Kit Bill of Materials (continued)

ITEM	REF DES	DNI/DNP	QTY	MFG PART #	MFG	VALUE	DESCRIPTION	NOTES
56	U12, U13	-	2	MAX17552ATB+	MAXIM	MAX17552ATB+	IC; CONV; ULTRA-SMALL; HIGH-EFFICIENCY; SYNCHROMOUS STEP-DOWN DC-DC CONVERTER; TDFN10-EP	
57	U14	-	1	MAX6126A41+	MAXIM	MAX6126A41	IC; VREF; ULTRA-HIGH PRECISION; ULTRA-LOW NOISE; SERIES VOLTAGE REFERENCE; UMAX8	
58	U15	-	1	MAX44244AUK+	MAXIM	MAX44244AUK+	IC; OPAMP; 36V; PRECISION; LOW-POWER; 90UA; SINGLE OP AMP; SOT23-5	
59	U16, U17	-	2	74LVC2G125DP	NXP	74LVC2G125DP	IC; DRV; DUAL BUS BUFFER/LINE DRIVER; 3-STATE; TSSOP8	
60	U18	-	1	93LC66BT-I/OT	MICROCHIP	93LC66BT-I/OT	IC; EPROM; 4K MICROWIRE SERIAL EEPROM; SOT23-6	
61	U20	-	1	MAX15006BATT+	MAXIM	MAX15006BATT+	IC; VREG; ULTRA-LOW QUIESCENT-CURRENT LINEAR REGULATOR; TDFN6-EP 3X3	
62	PCB	-	1	MAX11198	MAXIM	PCB	PCB:MAX11198	-
63	C60	DNP	0	GMK212B7105KG	TAIYO YUDEN	1.0UF	CAPACITOR; SMT (0805); CERAMIC; 1UF; 35V; TOL=10%; MODEL=GMK SERIES; TG=-55 DEGC TO +125 DEGC; TC=X7R	
64	C104, C105	DNP	0	C0603C102K1GAC	KEMET	1000PF	CAPACITOR; SMT (0603); CERAMIC CHIP; 1000PF; 100V; TOL=10%; MODEL=C0G; TG=-55 DEGC TO +125 DEGC; TC=C0G	
65	J18	DNP	0	PBC06SAAN	SULLINS ELECTRONICS CORP.	PBC06SAAN	CONNECTOR; MALE; THROUGH HOLE; BREAKAWAY; STRAIGHT; 6PINS; -65 DEGC TO +125 DEGC	
66	R25-R27	DNP	0	SEE NOTES	VISHAY DALE	20	RESISTOR; 0603; 20 OHM; 1%; 100PPM; 0.10W; THICK FILM	
TOTAL			251					



MAX11198 EV Kit Schematics

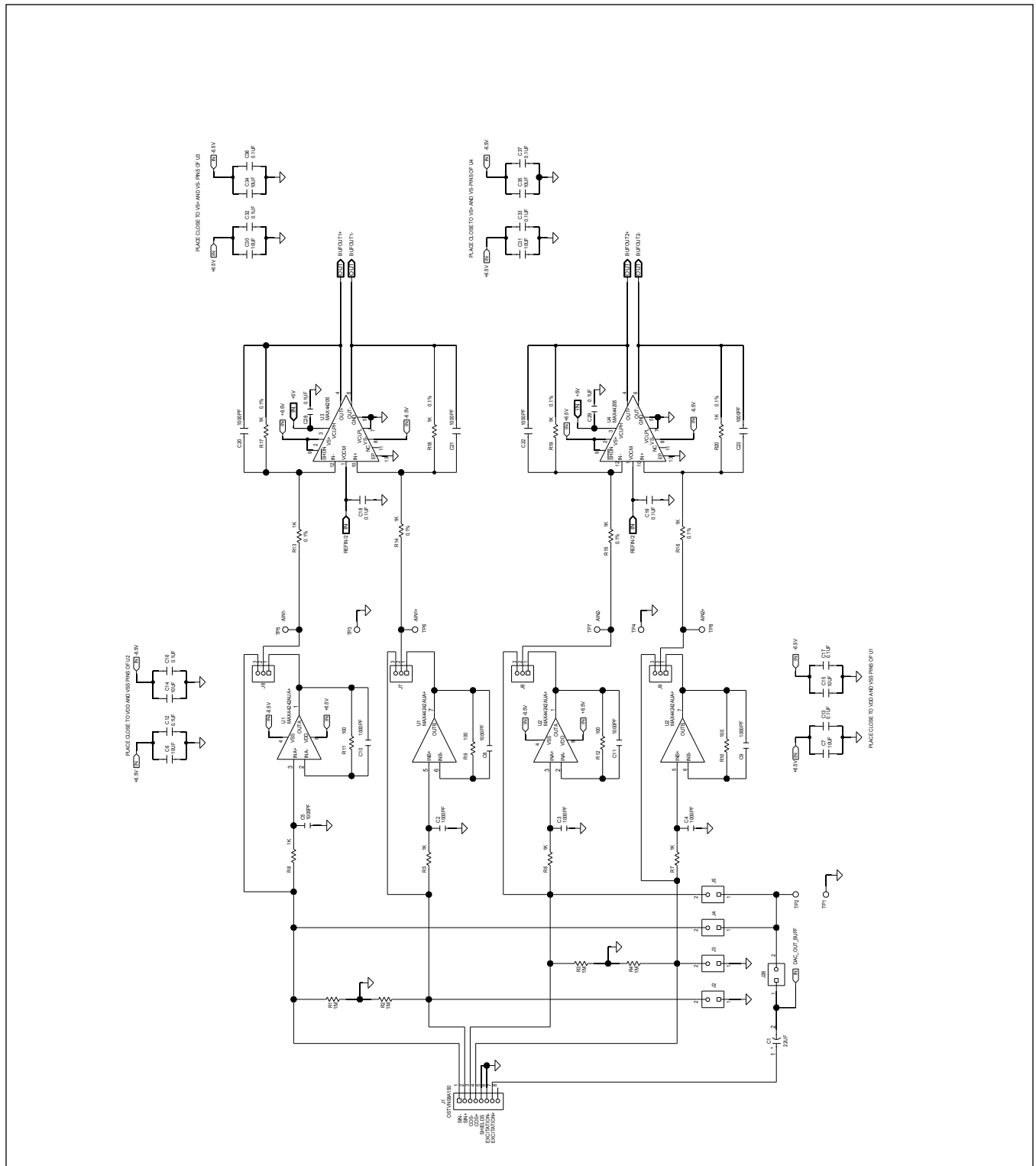



MAX11198 EV Kit Schematics (continued)

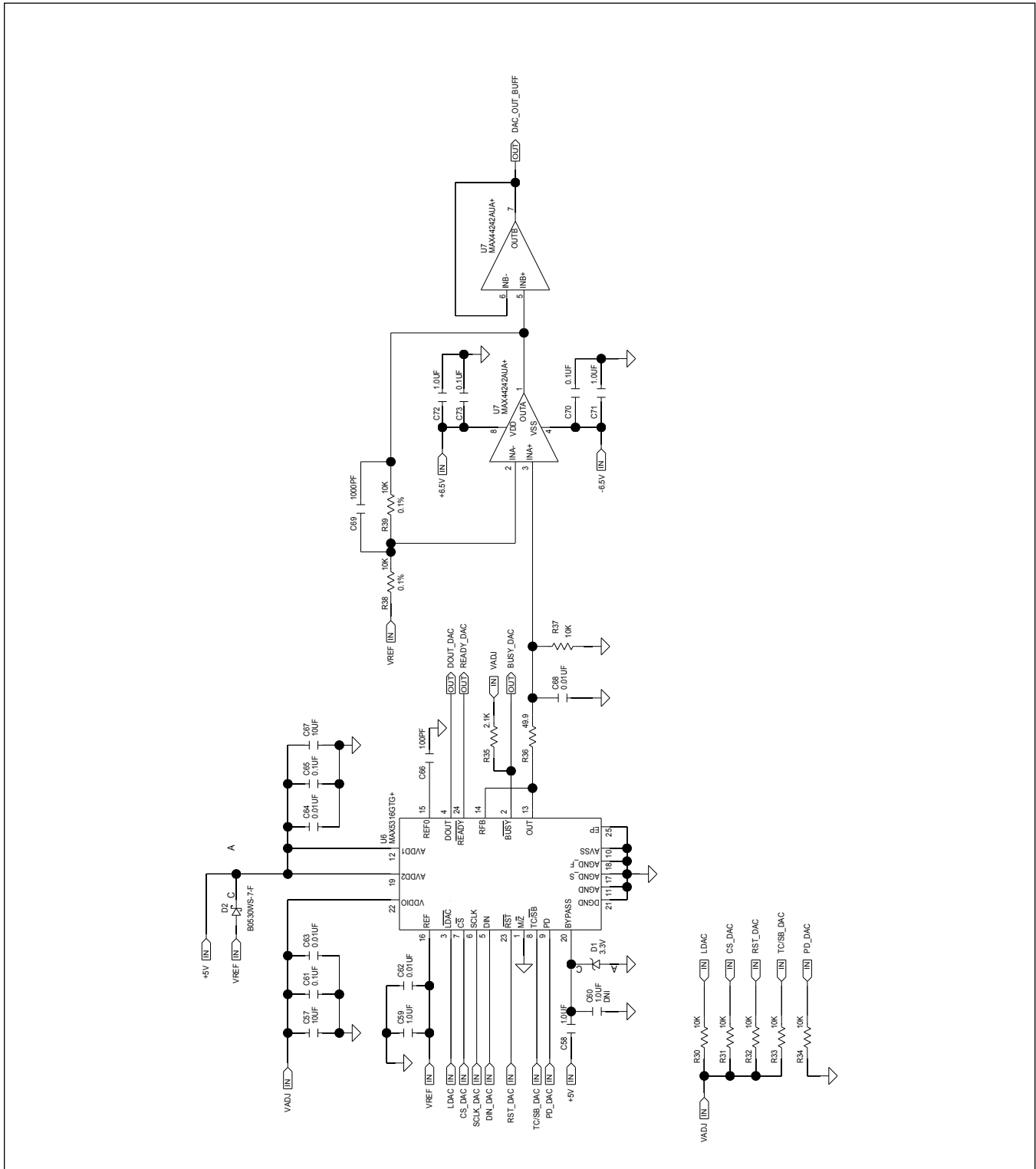

MAX11198 EV Kit Schematics (continued)

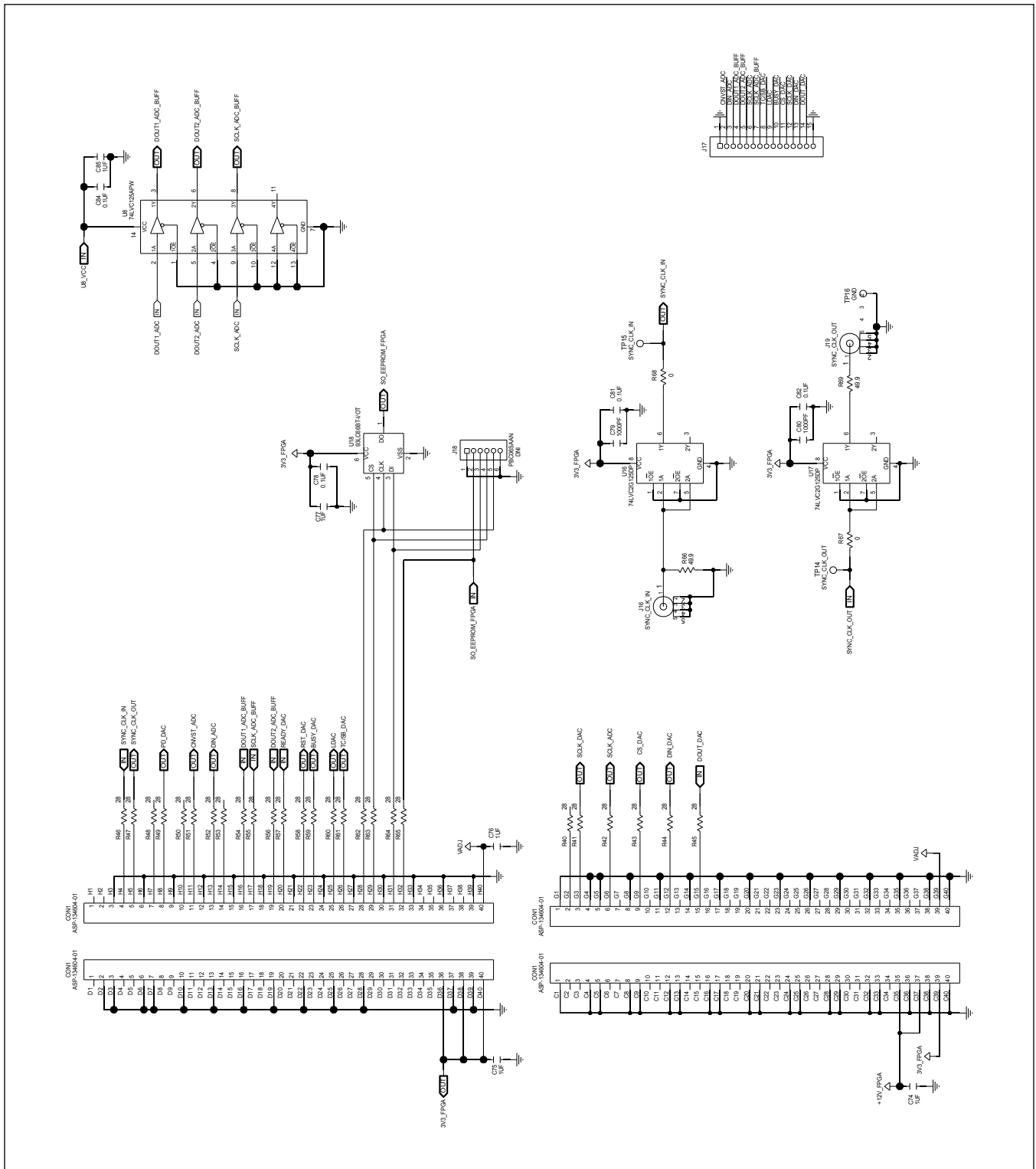

MAX11198 EV Kit Schematics (continued)

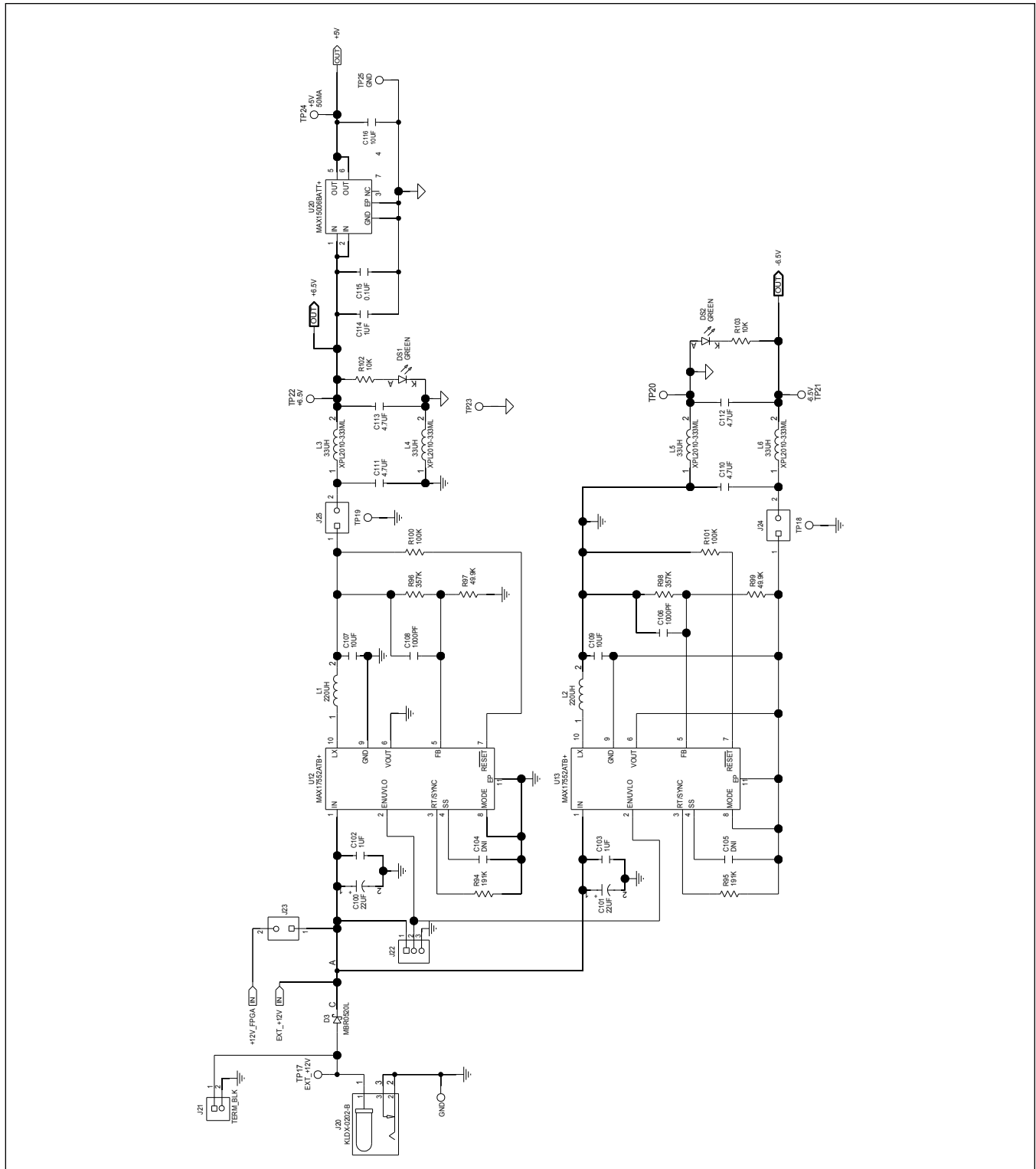

MAX11198 EV Kit PCB Layout Diagrams

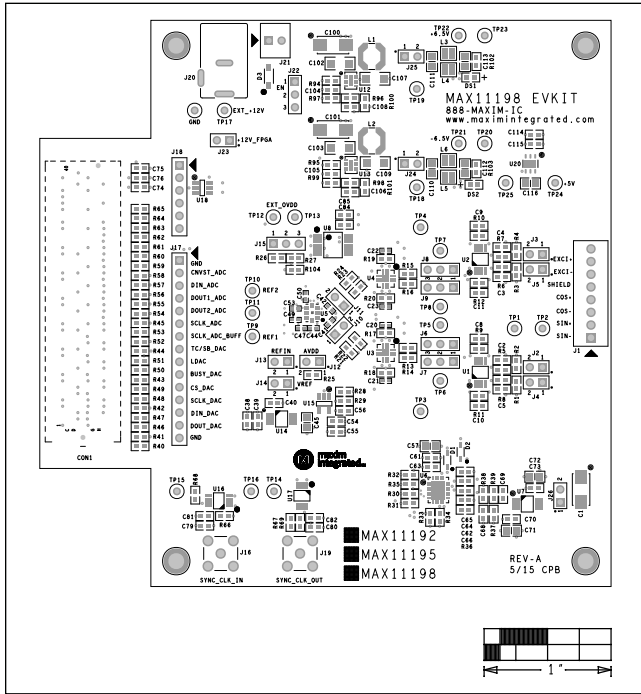

MAX11198 EV Kit—Top Silkscreen

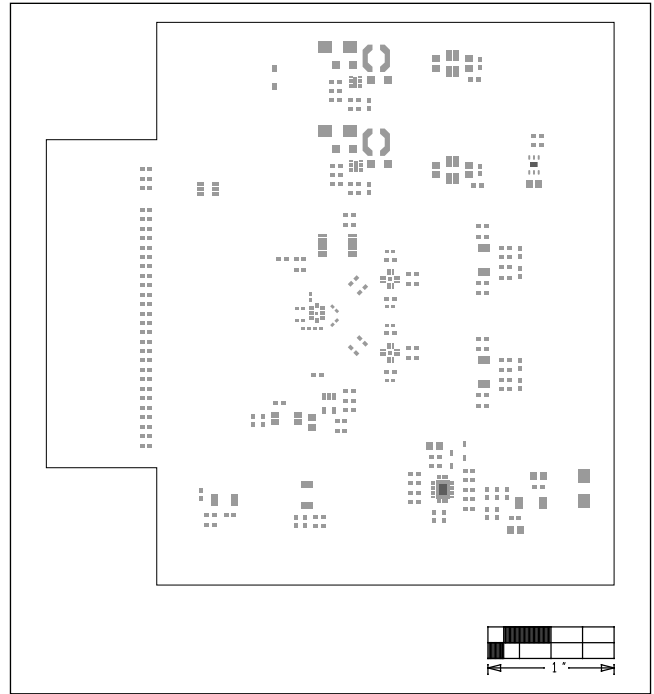

MAX11198 EV Kit—Top Paste

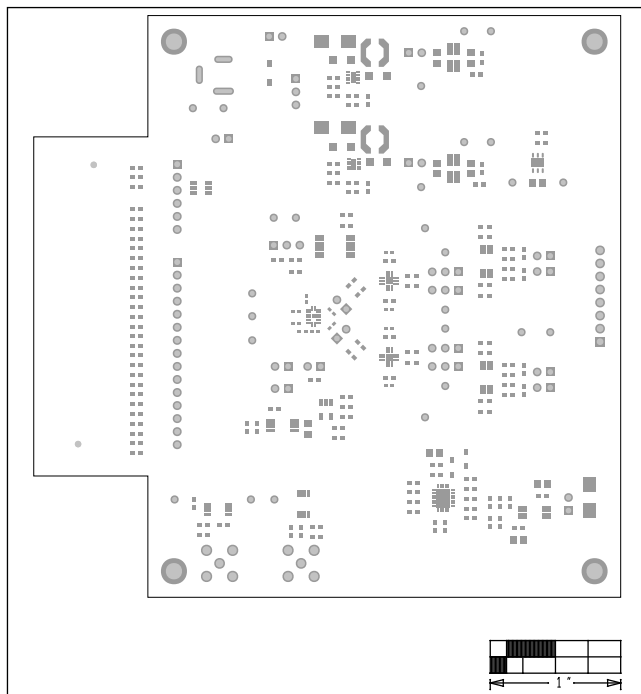

MAX11198 EV Kit—Top Mask

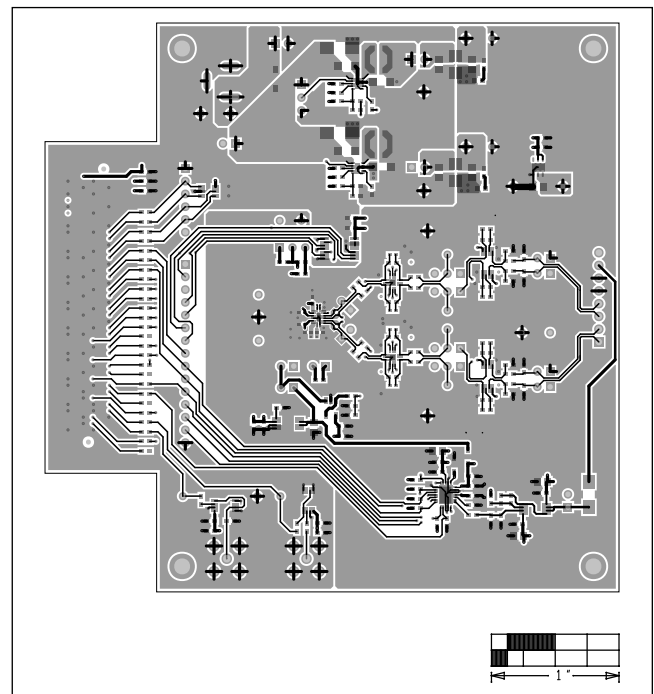

MAX11198 EV Kit—Top

MAX11198 EV Kit PCB Layout Diagrams (continued)

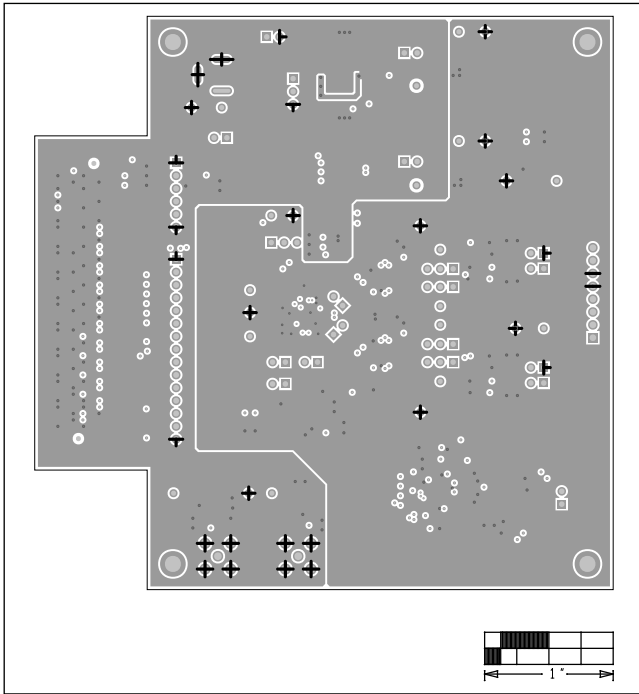

MAX11198 EV Kit—Internal 2

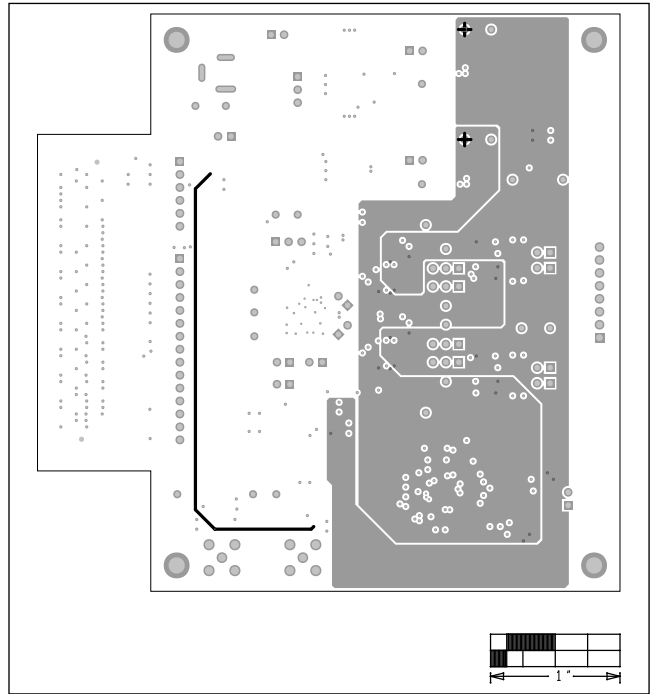

MAX11198 EV Kit—Internal 3

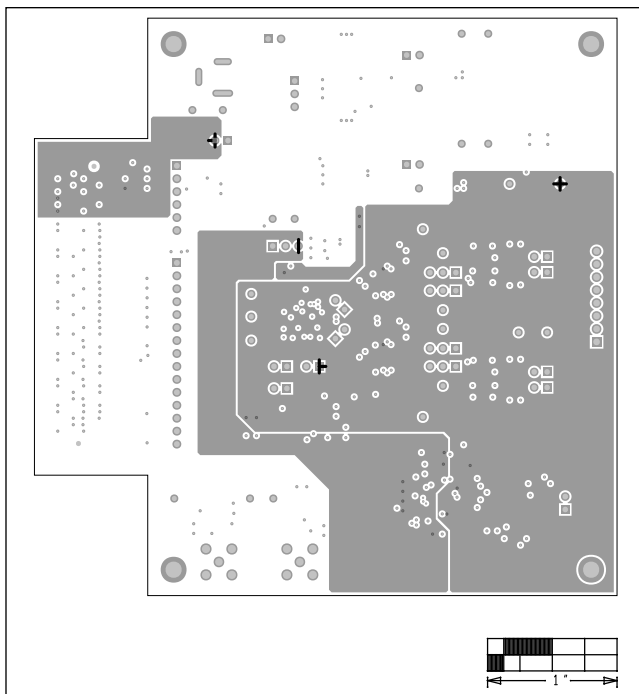

MAX11198 EV Kit—Internal 4

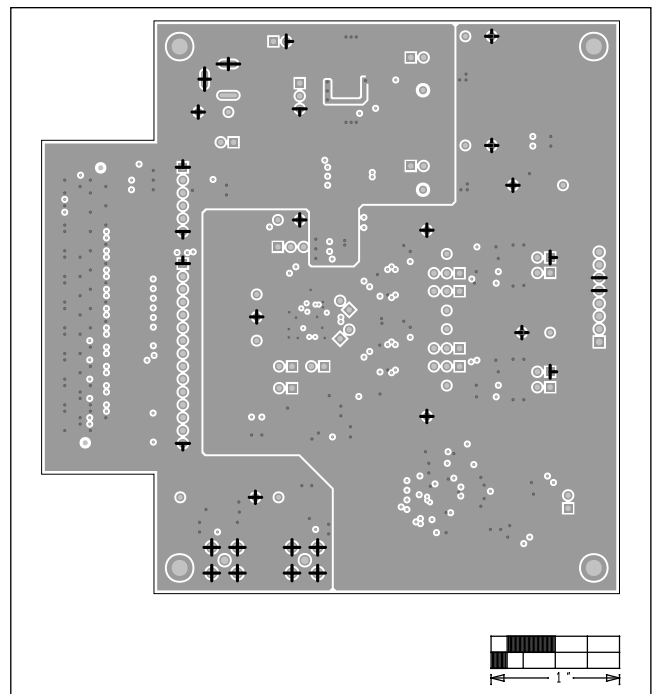

MAX11198 EV Kit—Internal 5





### Ordering Information

PART	TYPE
MAX11198EVKIT#	EVKIT

*#Denotes RoHS compliant.*

*Contact Avnet to purchase a ZedBoard (AES-Z7EV-7Z020-G) to communicate with the MAX11198 EV kit.*

### Revision History

REVISION NUMBER	REVISION DATE	DESCRIPTION	PAGES CHANGED
0	10/17	Initial release	—

For pricing, delivery, and ordering information, please contact Maxim Direct at 1-888-629-4642, or visit Maxim Integrated's website at [www.maximintegrated.com](http://www.maximintegrated.com).

*Maxim Integrated cannot assume responsibility for use of any circuitry other than circuitry entirely embodied in a Maxim Integrated product. No circuit patent licenses are implied. Maxim Integrated reserves the right to change the circuitry and specifications without notice at any time.*